

MELSEC A Series

Programmable Controller

User's Manual

AJ71E71

Ethernet Interface Module

REVISIONS

*The manual number is given on the bottom left of the back cover.

Print Date	*Manual Number	Revision
May, 1991	IB (NA) 66310-A	First edition
Jul., 1993	IB (NA) 66310-B	Correction CONTENTS, Section 2.2, 3.2, 4.3.3, 4.5.1, 5.2.1, 5.3.1, 5.3.2, 5.3.4, 6.3.3, 7.2.2, 8.4.2, 8.4.4, 8.4.8, 8.8.4, 9.1.2 to 9.1.4, APP.1 Addition APP.5

INTRODUCTION

Thank you for choosing the Mitsubishi MELSEC-A Series of General Purpose Programmable Controllers. Please read this manual carefully so that the equipment is used to its optimum. A copy of this manual should be forwarded to the end User.

CONTENTS

1. INTRODUCTION	1-1 ~ 1-6
1.1 Software Architecture	1-2
1.2 Features of AJ71E71	1-4
2. SYSTEM CONFIGURATION	2-1 ~ 2-4
2.1 Overall Configuration	2-1
2.1.1 Connection between an independent PC CPU and Ethernet / Cheapernet ..	2-1
2.1.2 Equipment necessary to construct a network	2-3
2.2 Applicable CPU Modules	2-4
3. SPECIFICATIONS	3-1 ~ 3-13
3.1 General Specifications	3-1
3.2 Performance Specifications	3-2
3.3 Data code used for communications	3-3
3.4 Function of AJ71E71	3-4
3.5 I/O Signals Used for the PC CPU	3-5
3.5.1 Details of I/O signals	3-6
3.6 Buffer Memory Map	3-13
4. PRE-OPERATION SETTINGS	4-1 ~ 4-11
4.1 Pre-Operation Settings	4-1
4.2 Handling Instructions	4-2
4.3 Nomenclature	4-3
4.3.1 LED signal names and indicator descriptions	4-4
4.3.2 Operating mode settings	4-5
4.3.3 Communications Condition Settings	4-6
4.4 Connecting to the Network	4-7
4.4.1 Connection to a 10BASE5 (Ethernet)	4-7
4.4.2 Connecting to a 10BASE2 (Cheapernet)	4-8
4.5 Self-Diagnostic Tests	4-10
4.5.1 Self-loopback test	4-10
4.5.2 RAM test	4-11
4.5.3 ROM test	4-11
5. COMMUNICATING WITH OTHER NODES	5-1 ~ 5-19
5.1 Communicating with other nodes	5-1
5.2 Initial Processing	5-3
5.2.1 Data for initial setting	5-3
5.2.2 Initial processing procedures	5-5
5.2.3 Initial processing state storage area	5-6
5.2.4 Sample initial processing program	5-7

5.3	Open/Close of a Communications Line	5-8
5.3.1	Data for opening a communications line	5-8
5.3.2	Open processing of communications line	5-13
5.3.3	Communications line status storage area	5-16
5.3.4	Open processing program example	5-19
6.	COMMUNICATIONS PROCESSING USING FIXED BUFFER MEMORY	6-1 ~ 6-13
6.1	Control Methods	6-1
6.1.1	Send Control Methods	6-2
6.1.2	Receive Control Methods	6-4
6.2	Data Format	6-6
6.2.1	Application Data Format	6-6
6.2.2	Subheader	6-7
6.2.3	Command/Response Format	6-8
6.2.4	Completion Code List	6-10
6.3	Programming	6-11
6.3.1	Precautions When Programming	6-11
6.3.2	Programming Procedure	6-12
6.3.3	Sample Communications Program	6-13
7.	COMMUNICATION PROCESSING USING RANDOM ACCESS BUFFER MEMORY AREA	7-1 ~ 7-15
7.1	Control Method	7-1
7.1.1	Communication Control in Response to Read Request from Other Node	7-3
7.1.2	Communication Control in Response to Write Request from Other Node	7-4
7.2	Data Format	7-5
7.2.1	Application Data Format	7-5
7.2.2	Subheader	7-6
7.2.3	Command/Response Format	7-7
7.2.4	List of End Codes	7-11
7.3	Data Storing Area	7-12
7.4	Programming	7-13
7.4.1	Cautions on Programming	7-13
7.4.2	Programming Procedure	7-14
8.	READING AND WRITING DATA STORED IN THE PC CPU	8-1 ~ 8-106
8.1	Control Method	8-1
8.1.1	Communications with a PC CPU which is loaded with an AJ71E71	8-2
8.1.2	Communications with a PC CPU in MELSECNET	8-3
8.2	Communicating Data	8-7
8.3	Data Format	8-9
8.3.1	Application data format	8-9
8.3.2	Subheader	8-10
8.3.3	Completion code	8-11
8.3.4	Error codes	8-13

8.4	Command/Response Format for Read/Write of Device Memory	8 - 14
8.4.1	Command and device range	8 - 14
8.4.2	Batch read in bit unit	8 - 18
8.4.3	Batch read in word unit	8 - 20
8.4.4	Batch write in bit unit	8 - 24
8.4.5	Batch write in word unit	8 - 26
8.4.6	Test (random write) in bit unit	8 - 30
8.4.7	Test (random write) in word unit	8 - 32
8.4.8	Monitoring device memory	8 - 34
8.5	Command and Response Formats for Read/Write of Extension File Register	8 - 42
8.5.1	Commands and addresses	8 - 42
8.5.2	Precautions for read/write of extension file registers	8 - 43
8.5.3	Batch read of extension file register	8 - 44
8.5.4	Batch write of extension file register	8 - 46
8.5.5	Test (random write) of extension file register	8 - 48
8.5.6	Monitoring extension file register	8 - 50
8.5.7	Direct read/write of extension file registers	8 - 55
8.6	Command/response Format for Read/Write of Special-function Module Data	8 - 61
8.6.1	Commands and method of specification	8 - 61
8.6.2	Special-function module No. to be used with a command	8 - 63
8.6.3	Reading special-function module buffer memory	8 - 65
8.6.4	Writing special-function module buffer memory	8 - 67
8.7	Command and Response Formats for the Remote RUN/STOP and CPU Model	
	Name Read	8 - 69
8.7.1	Function	8 - 69
8.7.2	Remote RUN/STOP	8 - 70
8.7.3	Read of PC CPU model name	8 - 72
8.8	Command/Response Format for Read/Write of a Program	8 - 74
8.8.1	Precautions for read/write of a program	8 - 74
8.8.2	Operation procedure	8 - 75
8.8.3	Read/write of parameter memory	8 - 77
8.8.4	Read/write of sequence program	8 - 82
8.8.5	Read/write of a microcomputer program	8 - 92
8.8.6	Read/write of comment	8 - 96
8.8.7	Read/write of extension comment	8 - 100
8.9	Command and Response Formats for the Loopback Test	8 - 104
9.	TROUBLESHOOTING	9 - 1 ~ 9 - 15
9.1	Error Code List	9 - 1
9.1.1	Initialization error code list	9 - 1
9.1.2	Communication line opening error code list	9 - 2
9.1.3	Fixed buffer send error code list	9 - 3
9.1.4	List of error codes stored in error log area	9 - 4
9.2	Troubleshooting Flowchart	9 - 6
9.2.1	Send error in communications using fixed buffer	9 - 8

9.2.2	Receive error in communications using fixed buffer	9-10
9.2.3	Error in communications using random access buffer	9-12
9.2.4	Read/write error of data in PC CPU	9-14

APPENDICES APP-1 - APP-27

APPENDIX 1	PROCESSING TIME	APP-1
APPENDIX 2	ASCII CODE TABLE	APP-8
APPENDIX 3	REFERENCE	APP-9
APPENDIX 4	EXTERNAL VIEW	APP-10
APPENDIX 5	SAMPLE PROGRAMS	APP-11

1. INTRODUCTION

This manual gives the specifications, handling and programming method of the AJ71E71 Ethernet interface module (hereafter called the AJ71E71) which is used to connect an A-series PC CPU to a CSMA/CD network. (The CSMA/CD network conforms to IEEE802.3.)

The AJ71E71 functions as a node in 10BASE5 (Ethernet) or 10BASE2 (Cheapernet) network. Incorporating AJ71E71s into such networks allows data communications between an A-series PC CPU and a personal computer, or between A-series PCs.

The Ethernet and Cheapernet interfaces are switchable by using a switch on the front of the AJ71E71 module. (See Section 4.3.)

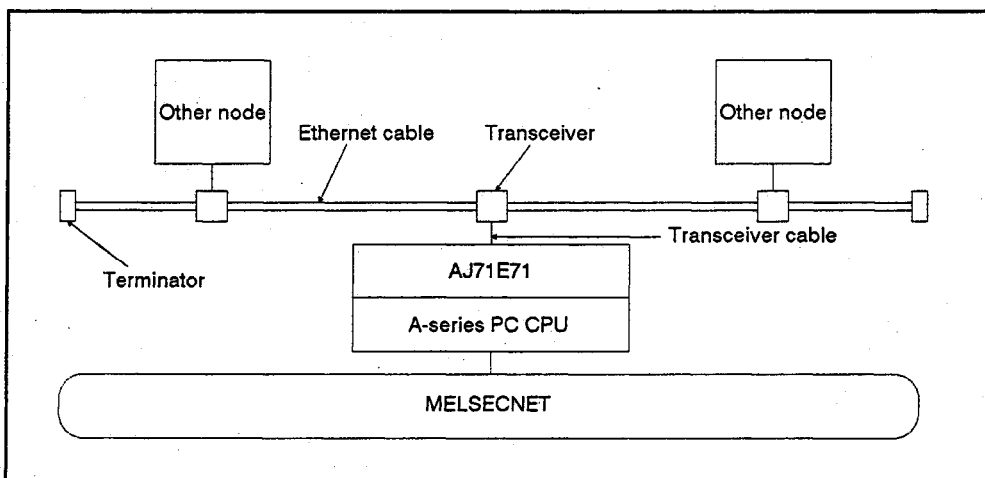

Fig. 1.1 10BASE5 (Ethernet) Connection

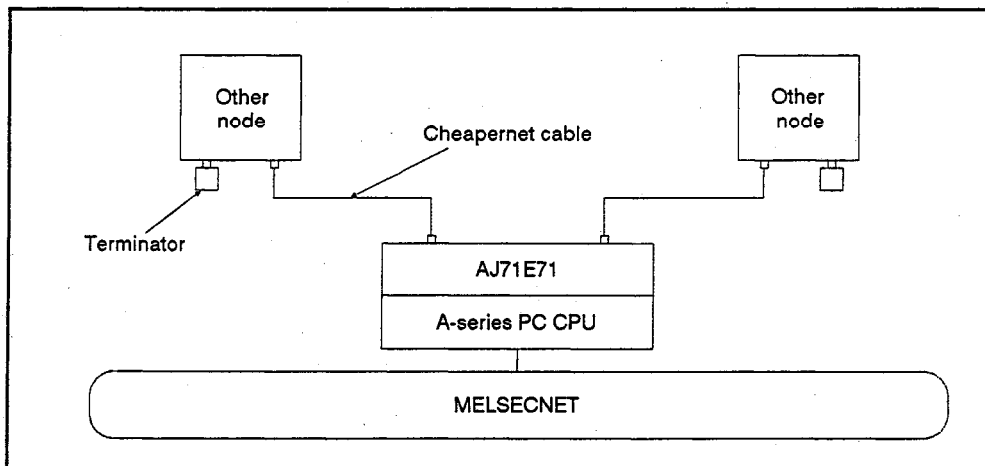

Fig. 1.2 10BASE2 (Cheapernet) Connection

Confirm that the following product is contained in the AJ71E71 package.

See Section 2.1.2 for the parts and materials necessary in addition to this product.

Product Name	Number
AJ71E71 Ethernet Interface Module	1

1.1 Software Architecture

The AJ71E71 supports two kinds of protocols; TCP/IP and UDP/IP.

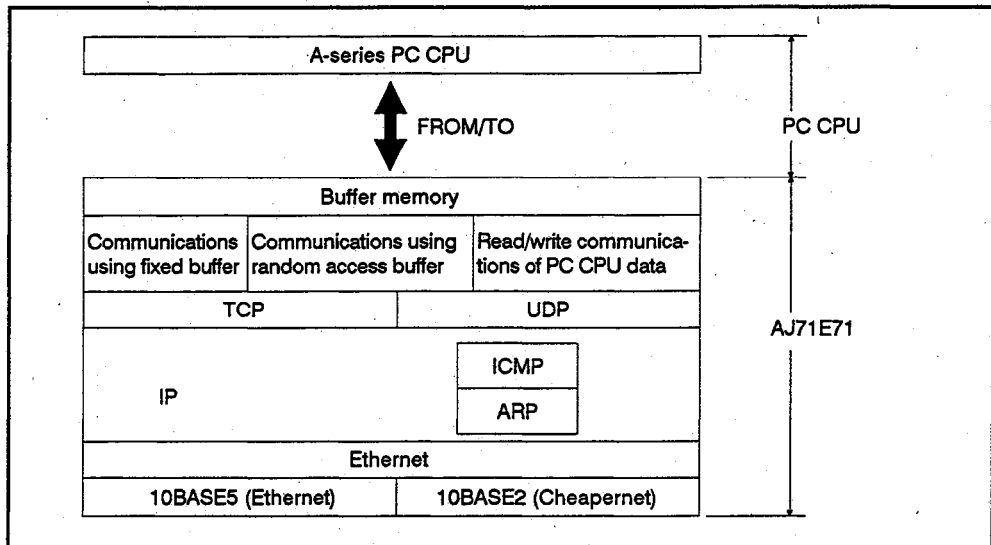

Fig. 1.3 Software Architecture

(1) TCP (Transmission Control Protocol)

This protocol guarantees the reliability or the certainty of data.

- By establishing a connection between nodes, this protocol makes a logical connection which is used exclusively for communications between the nodes.
- Up to 8 connections can be established simultaneously. Also, simultaneous communications using several buffers is possible.
- Reliability of data is assured by the sequential control using sequence numbers, the retransmission function of data, and the use of the check sum.
- Flow of communications data is controlled by the window operation.
- The MAX SEGMENT option is supported.

(2) UDP (User Datagram Protocol)

This protocol does not guarantee the reliability and the certainty of data.

Therefore, even if data fails to reach to a destination node, the data is not retransmitted.

- Because connections are not necessary, a high-speed communications is enabled.
- Check sum is added to improve reliability of communications data.
- However, if higher reliability is necessary, use a user application or TCP.

(3) IP (Internal Protocol)

- This protocol transmits/receives the communications data in the datagram form.
- This protocol can split and assemble communications data.
- This protocol does not support a routing option.

(4) ARP (Address Resolution Protocol)

- This calculates the Ethernet physical address from the IP address by the broadcast function.

(5) ICMP (Internal Control Message Protocol)

- This has the function that transmits the error messages of the IP.
- This does not support the ICMP options.

1.2 Features of AJ71E71

The following describes features of the AJ71E71.

- (1) Data communications with a specific node by handshaking (Fixed buffer communications)

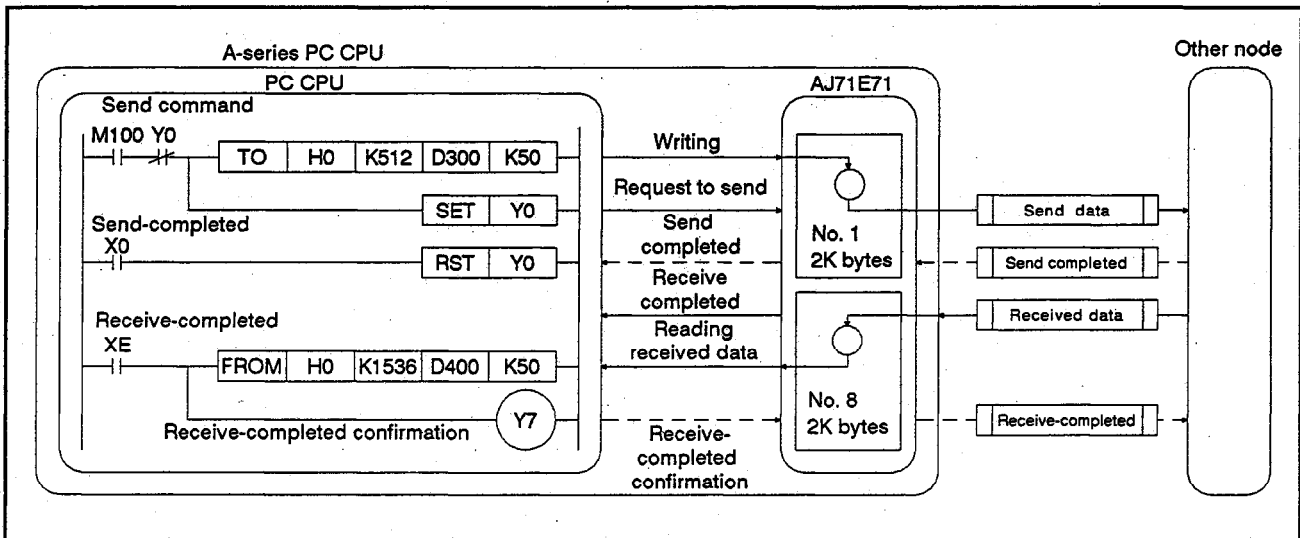

Fig. 1.4. Fixed Buffer Communications

- (a) The PC CPU can write send data to the AJ71E71 and can read received data from the AJ71E71 while using handshaking with other nodes.
- (b) When communications is done using fixed buffer, communications (data transmission/receive) with specific nodes can be done.

When data transmission and receive are done with a specific node, 2 fixed buffer areas are required. Communicating nodes and the type of communications (send or receive) for each fixed buffer area are set with communications parameters.

Communications between two AJ71E71s is also possible.

- (c) There are 8 fixed buffer areas from No. 1 to No. 8 (1K words/area). (Section 3.3 gives details of allowable data capacity per communications.)

(2) Communications by read/write requests from several nodes (Random access buffer communications)

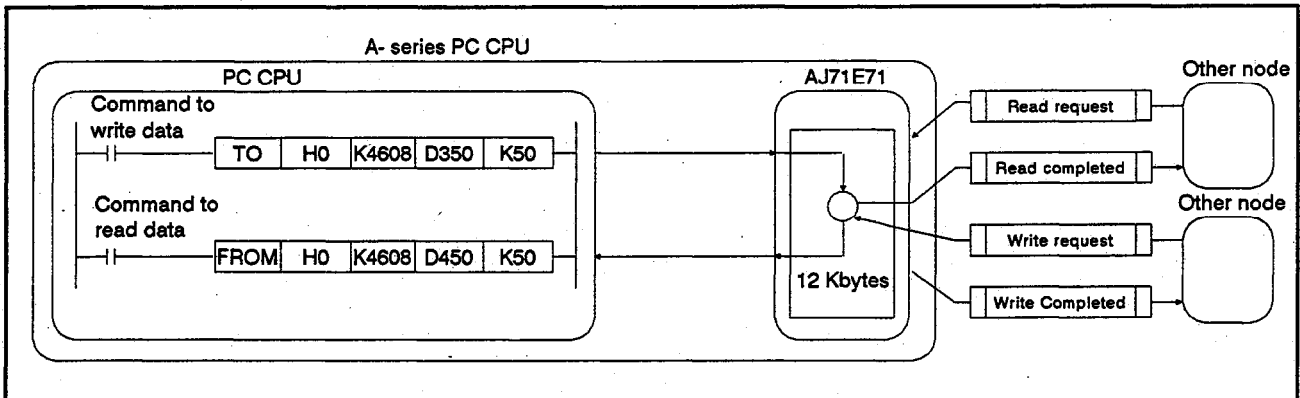

Fig. 1.5 Random Access Buffer Communications

- (a) When random access buffer is used, data read/write with several nodes can be done with one same buffer address.

However, because the communications between a PC CPU and communicating nodes is asynchronous, the user has to add interlock processing.

- (b) The random access buffer holds 6K words (3K for channel 0 and 3K for channel 1).

Buffer area is not set for each connection.

- (c) The PC CPU reads and writes data to and from the random access buffer by switching channels in the 3K word unit.

However, communicating nodes use this buffer area as one continuous area of 6K words. (Section 3.3 gives details of allowable data capacity per communications.)

(3) Read/write of data in the PC CPU by the request from other nodes

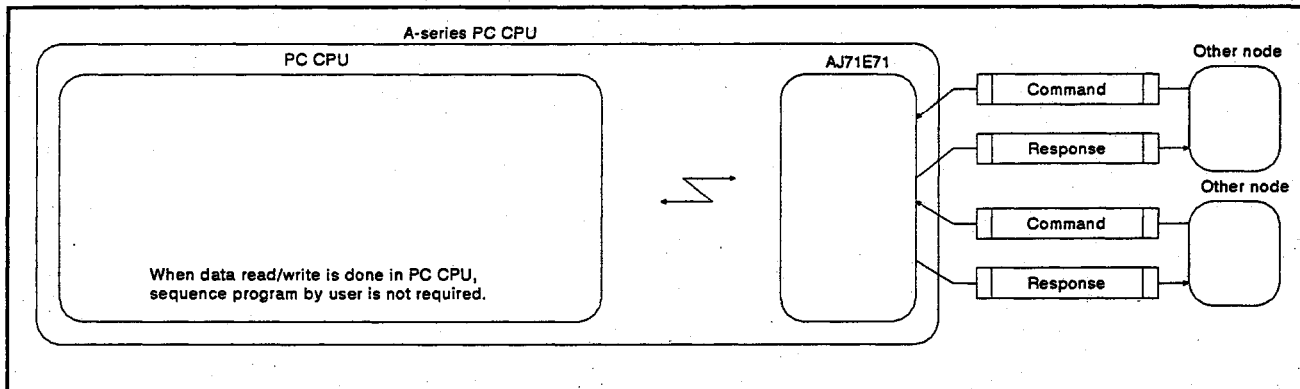

Fig. 1.6. Data Read/Write in the PC CPU

- (a) Upon receiving a read/write request for the data in the PC CPU from communicating nodes, the AJ71E71 transmits or receives the data of devices, programs, comments and parameters.
 - (b) When a PC CPU which is loaded with an AJ71E71 is connected to MELSECNET, data communications can be done with the PC CPUs in the MELSECNET. (See Section 8.1.2.)
 - (c) Since data communications is done between the AJ71E71 and communicating nodes, any special sequence program to perform data communications is not needed.
- (4) Selection (ASCII/binary) of the data code of communications data is enabled.

Communications data code used between the AJ71E71 and other nodes can be set to either ASCII or binary.

(See Section 3.3.)

- (5) Communications method (TCP/IP and UDP/IP) can be selected.

Each connection (communicating node) can select either TCP/IP or UDP/IP for communications with the AJ71E71.

(See Section 5.3.)

2. SYSTEM CONFIGURATION

This section explains the system configuration that can be used with the AJ71E71.

2.1 Overall Configuration

2.1.1 Connection between an independent PC CPU and Ethernet/Chepernet

- (1) When a PC CPU which is not connected to the MELSECNET data link is connected with Ethernet/Chepernet, use the following system configuration.

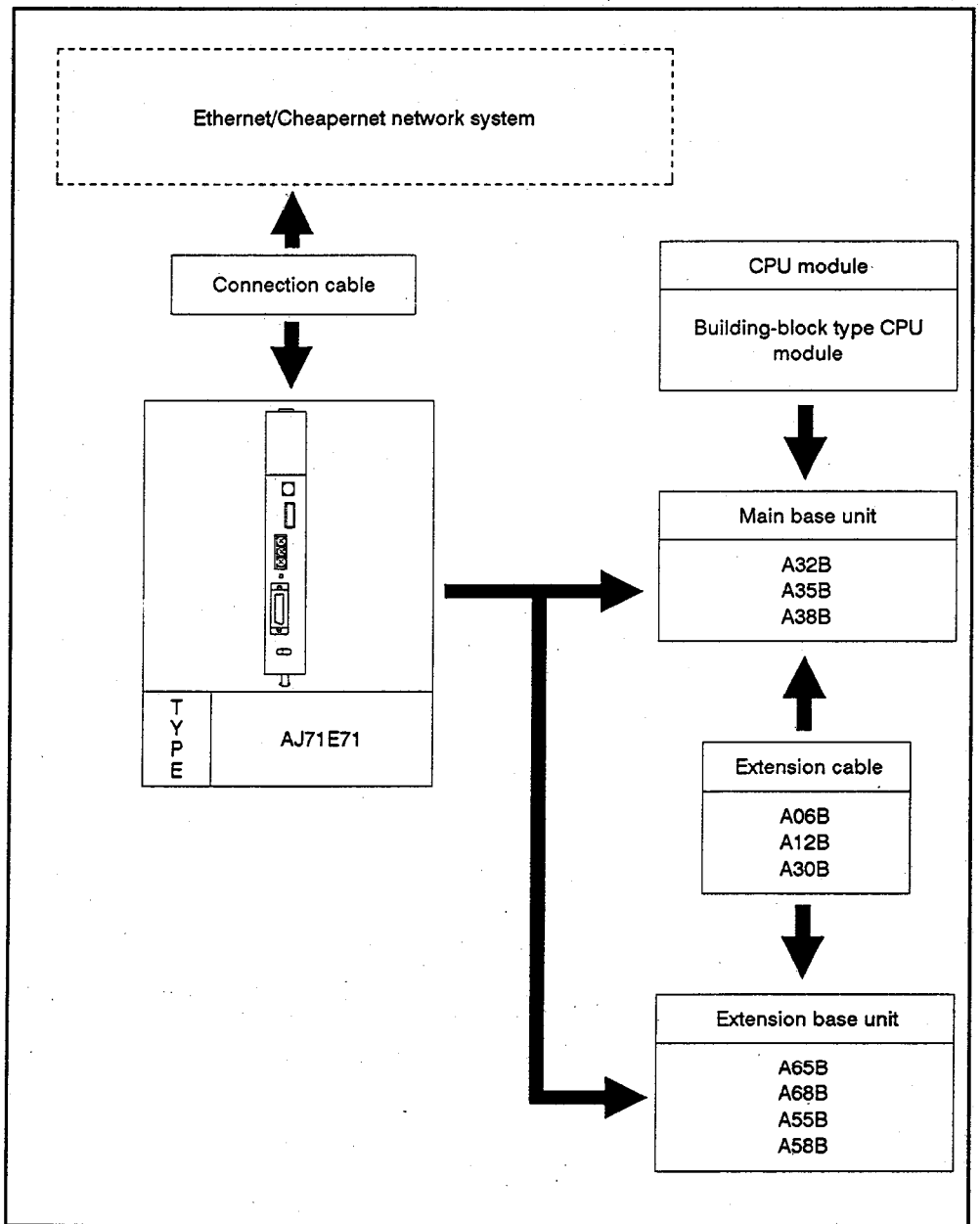

Fig 2.1 System Configuration Containing an Independent PC CPU

*Section 2.1.2 gives the equipment to be prepared by the user.

2. SYSTEM CONFIGURATION

MELSEC-A

- (2) When a PC CPU connected to MELSECNET is used, use the following system configuration.

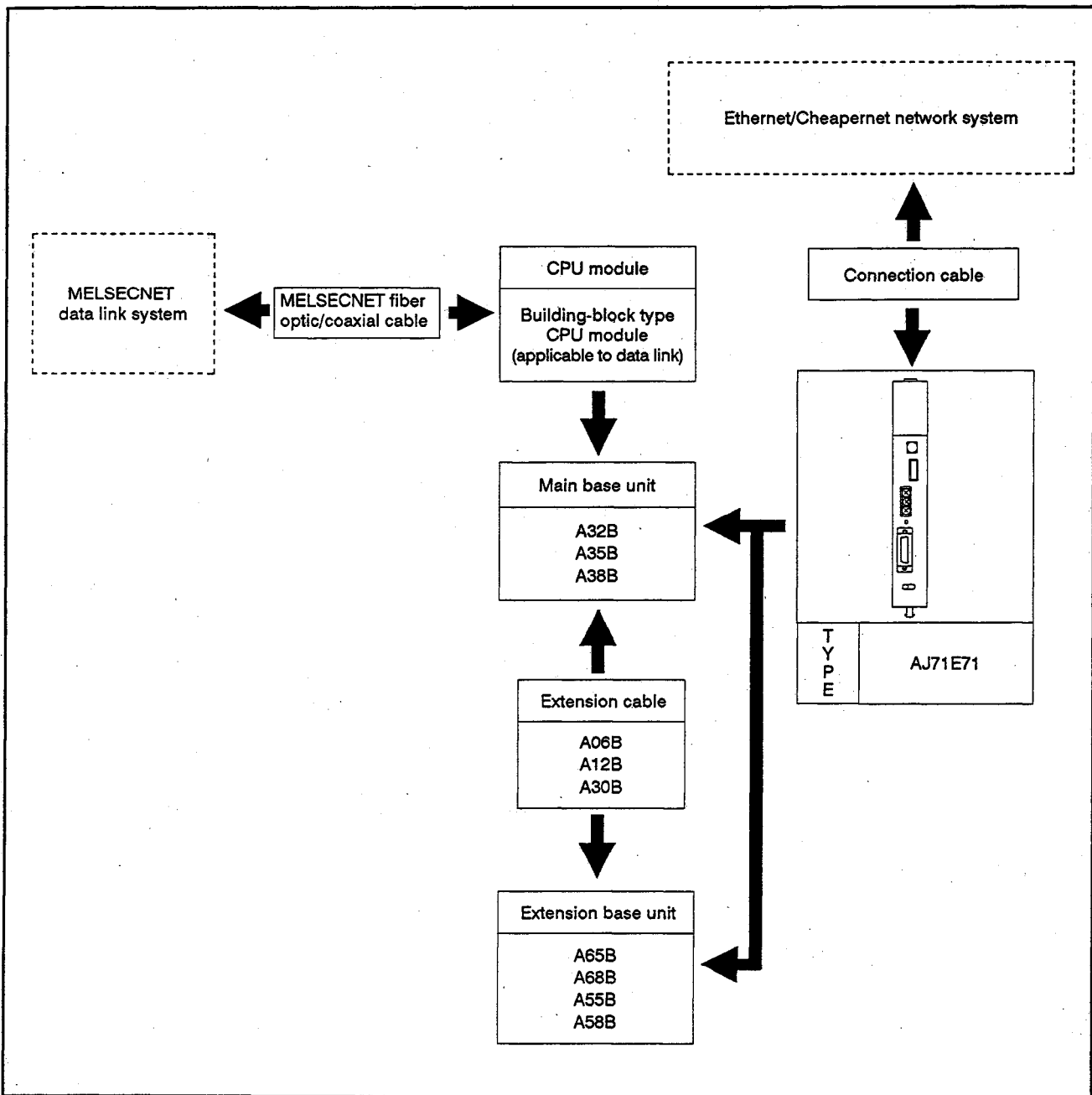

Fig. 2.2 System Configuration Using a PC CPU in MELSECNET

*Section 2.1.2 gives the equipment to be prepared by the user.

2.1.2 Equipment necessary to construct a network

- (1) Users must prepare the equipment shown in Figure 2.3 which is necessary to construct a 10BASE5 (Ethernet) network.
 - (a) Use the coaxial cables for Ethernet, the N type connectors, the N type terminators, the transceivers and the transceiver cables that satisfy the standards for IEEE 802.3 10BASE5.
 - (b) Use a 12 VDC power supply for the transceivers that satisfies the specifications of the transceiver and the transceiver cables considering the voltage drop (0.8 V maximum) of the AJ71E71.

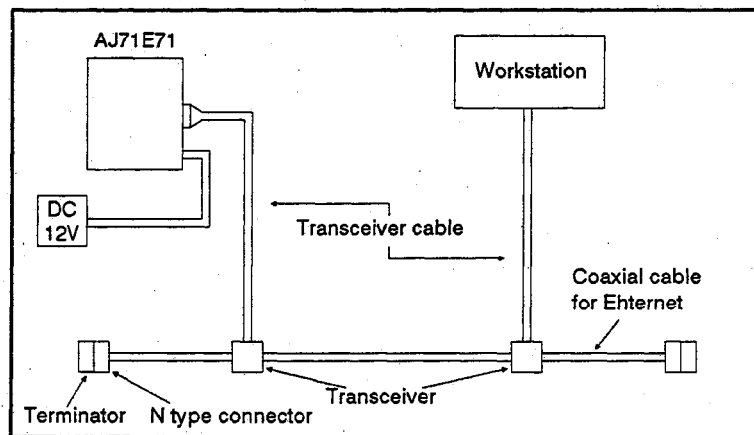

Fig. 2.3 Network System Configuration Example

- (2) Users must prepare the equipment shown in Figure 3.4 which are necessary to construct a 10BASE2 (Cheapernet) network.
 - (a) Coaxial cable for Ethernet
RG-58/U
 - (b) BNC plug (for the connection to AJ71E71)
BNC-P-58U (DDK) or equivalent
 - (c) Terminator
Plug type terminator (BCN type)

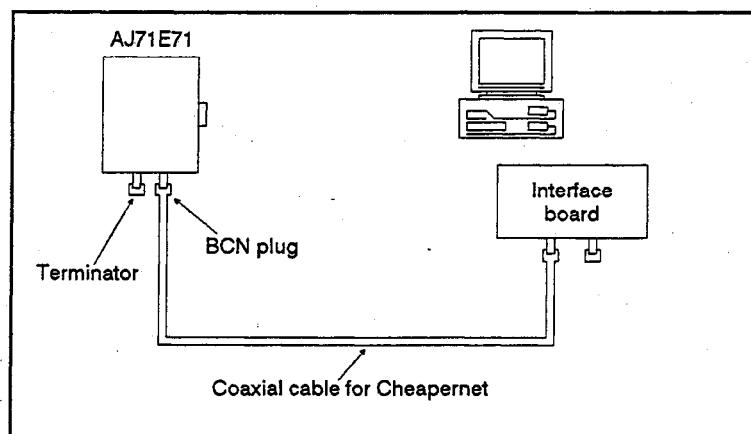

Fig. 2.4 Network System Configuration Example

2.2 Applicable CPU Modules

The AJ71E71 can be used with the following CPU modules.

(1) Applicable CPU modules and the maximum number of AJ71E71s

The table below shows the types of PC CPU modules and the maximum number of AJ71E71 modules which can be installed to work with the PC CPU.

The following CPU modules include those which can be linked with MELSECNET.

[Example A1CPU shown below indicates that A1CPUP21 and A1CPUR21 can also be loaded with AJ71E71s.]

Table 2.1 Applicable CPU Modules

CPU module	Maximum number of Modules	Note
A0J2H, A1S A1, A1N A2(-S1), A2N(-S1) A3, A3N, A3H, A3M A73	2	When the following modules are used with the AJ71E71, they must be included in the maximum number of modules. <ul style="list-style-type: none"> • A0J2-C214S1 Computer Link/Multidrop Link Module (only when the computer link function is used) • AD51(S3), AD51H(S3) Intelligent Communication Module • AJ71C21(S1) Terminal Interface Module (only when the BASIC program mode is used) • AJ71C22(S1) Multidrop Link System Module • AJ71C23 Higher Controller High-Speed Link Module • AJ71C24(S3/S6/S8) Computer Link Module
A2A(-S1) A3A	6	<ul style="list-style-type: none"> • AJ71C22(S1) Multidrop Link System Module • AJ71C23 Higher Controller High-Speed Link Module • AJ71C24(S3/S6/S8) Computer Link Module

(AJ71E71 cannot be used with an A0J2CPU, A2CCPU and A52GCPU.)

(2) Applicable base unit

The AJ71E71 can be loaded to any slot of the main base unit or extension base unit with these two exceptions:

- (a) The power supply capacity may be insufficient to load the AJ71E71 to an extension base unit with no built-in power supply (A55B or A58B).

When ever possible, avoid loading an AJ71E71 module into this type of extension base unit.

If it is necessary to use an AJ71E71 module on an extension base unit with no built-in power supply, it is important to consider (a) the power supply capacity of the main base unit and (b) the voltage drop along the extension cables when selecting the power supply module and the extension cables.

(The User's Manual of the CPU module gives details.)

- (b) The AJ71C24 must not be loaded to the last slot of the A3CPU's 7th extension base unit.

3. SPECIFICATIONS

This chapter describes the general specifications performance specifications, and I/O conversion characteristics, and I/O conversion characteristics of the AJ71E71.

3.1 General Specifications

Table 3.1 shows the general specifications of the AJ71E71.

Table 3.1 General Specifications

Item	Specifications				
Operating ambient temperature	0 to 55°C				
Storage ambient temperature	-20 to 75°C				
Operating ambient humidity	10 to 90%RH, non-condensing				
Storage ambient humidity	10 to 90%RH, non-condensing				
Vibration resistance	Conforms to *JIS C 0911	Frequency	Acceleration	Amplitude	Sweep Count
		10 to 50Hz	—	0.075mm (0.003 in)	10 times *(1 octave/minute)
		10 to 150Hz	1g	—	
Shock resistance	Conforms to *JIS C 0912 (10g x 3 times in 3 directions)				
Noise Durability	By noise simulator of 1500 Vpp noise voltage, 1 μ s noise width and 25 to 60 Hz noise frequency.				
Dielectric withstand voltage	500 VAC for 1 minute across DC external terminals and ground				
Insulation resistance	5 M Ω or larger by 500 VDC insulation resistance tester across AC external terminals and ground				
Operating ambience	Free of corrosive gases. Dust should be minimal.				
Cooling method	Self-cooling				

REMARK

One octave marked * indicates a change from the initial frequency to double or half frequency. For example, any of the changes from 10 Hz to 20 Hz, from 20 Hz to 40 Hz, from 40 Hz to 20 Hz, and 20 Hz to 10 Hz are referred to as one octave.

* JIS: Japanese Industrial Standard

3. SPECIFICATIONS

MELSEC-A

3.2 Performance Specifications

Table 3.2 Performance Specifications

Item		Specifications	
		10BASE5 (Ethernet)	10BASE2 (Cheapernet)
Transmission specifications	Data transmission velocity	10 Mbps	
	Transmission method	Base band	
	Network length (m) (ft)	2500 (8202.50)	925 (3034.93)
	Max. segment length (m) (ft)	500 (1640.50)	185 (606.99)
	Max. number of nodes	100/segment	30/segment
	Min. node interval (m) (ft)	2.5 m (8.20)	0.5 m (1.64)
Communications data storage memory	Fixed buffer	2 Kbytes x 8	
	Random access buffer	12 Kbytes x 1	
Number of inputs and outputs		32 points	
Voltage consumed (A)		1.5	
Outside dimensions (mm) (in)		250H x 37.5 W x 11.9 D (9.84H x 1.48 W x 0.47 D)	
Weight (kg) (lb)		0.6 (1.32)	

3.3 Data code used for communications

The following explains the data code used for communications between an AJ71E71 and communicating nodes or between an AJ71E71 and a PC CPU.

(1) Data code used for communications

Between AJ71E71 and other nodes Switching of binary/ASCII code is enabled.

Between AJ71E71 and a PC CPU Binary code

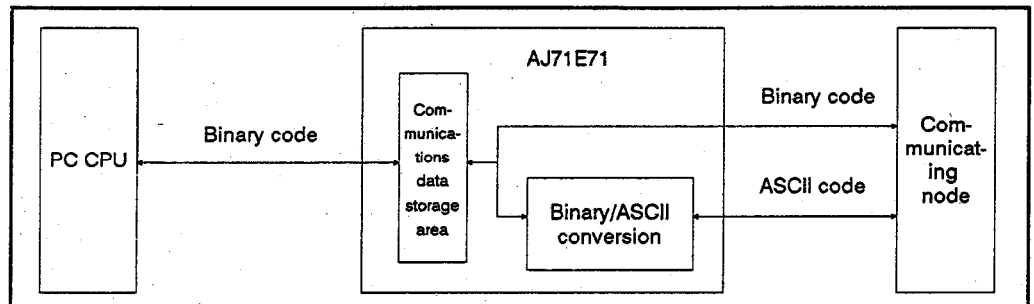

Fig. 3.1 Code system of communication data

(2) Switch from binary to ASCII by using a DIP switch on the front of AJ71E71.

As for the details, refer to Section 4.3.3.

(3) When communications is done in the ASCII code, 1-byte binary code data is converted automatically to 2-byte ASCII code.

Example:

Binary code data	ASCII code data
15H	31H, 35H "1" "5"
(1 byte)	(2 bytes)
1234H	31H, 32H, m33H, 34H "1" "2" "3" "4"
(2 bytes)	(4 bytes)

(4) The data capacity that can be communicated at one time between an AJ71E71 and other node varies as follows according to the function and data code (binary/ASCII).

Function	Data Code	Binary Code	ASCII Code
Communications using fixed buffer		Maximum 1017 words	Maximum 508 words
Communications using random access buffer			
Read/write of data in the PC CPU		Up to the maximum number of words that can be set with each command when either data code is used.	

3. SPECIFICATIONS

3.4 Function of AJ71E71

Table 3.3 Functions of AJ71E71

Function	Description	Communicating Nodes		
		Other node ↓ AJ71E71	AJ71E71 ↓ Other node	AJ71E71 ↓ AJ71E71
Communications using fixed buffer	<p>(1) Using the handshaking signal in the one-to-one connection ratio, a PC CPU performs communications with nodes in Ethernet/Cheapernet. (Communications between two AJ71E71s are also possible.)</p> <p>(2) There are 8 areas (1K words per 1 area) to do communications with other nodes. (Section 3.3 gives the data capacity per one time of communication.)</p> <p>(3) Set a communicating node and the type (send/receive) at fixed buffer by using communications parameters. Two fixed buffer areas are needed to do data send and receive with one node.</p> <p>(4) Communications with up to 8 nodes for which connection has been opened in Ethernet/Cheapernet are possible.</p>	o	o	o
Communications using random access buffer memory	<p>(1) Read/write communications is possible between several nodes and the random access buffer memory of the AJ71E71. (Communications between AJ71E71s is impossible.)</p> <p>(2) The area used for communications with other nodes has 6K words (channel 1: 3K words and channel 0: 3K words). The PC CPU can read/write data using all areas by switching the channels. Communicating nodes can read/write data using the area as one continuous area. (Section 3.3 gives the data capacity per one time of communication.)</p> <p>(3) The random access area is not provided with allocated connections. This buffer can be used as common buffer memory in the network.</p> <p>(4) Communications with up to 8 nodes for which connection has been opened in Ethernet/Cheapernet is possible.</p>	o	/	x
Read/write communications of data in the PC CPU	<p>(1) Upon receiving a request from a communicating nodes, the AJ71E71 can read/write data of devices, programs, comments and parameters in the PC CPU which is loaded with the AJ71E71.</p> <p>(2) When a PC CPU which is loaded with an AJ71E71 is connected to MELSECNET, data communications can be done between any node and any PC CPU in the MELSECNET.</p> <p>(3) Communications with up to 8 nodes for which connection has been opened in Ethernet/Cheapernet is possible.</p>	o	/	x
Self-loopback test	<p>(1) The AJ71E71 hardware containing the data transmission and receive circuits is checked.</p>	/	/	/

3. SPECIFICATIONS

3.5 I/O Signals Used for the PC CPU

The following list shows the I/O signals used for communications between the AJ71E71 and the PC CPU.

The X/Y number allocation in the following table is used when the AJ71C24 is loaded in slot 0 of the main base unit.

Devices X indicate the input from an AJ71E71 to a PC CPU, and devices Y indicate the output from a PC CPU to an AJ71E71.

Table 3.4 I/O Signals for PC CPU

Signal direction AJ71E71 → PC CPU			Signal direction PC CPU → AJ71E71		
	Signal			Signal	
X0	Send-completed or receive-completed	Connection No. 1 fixed buffer communications	Y0	Connection No. 1	Send request or receive-completed confirmation
X1	Send error-detected		Y1	Connection No. 2	
X2	Send-completed or receive-completed		Y2	Connection No. 3	
X3	Send error-detected		Y3	Connection No. 4	
X4	Send-completed or receive-completed		Y4	Connection No. 5	
X5	Send error-detected		Y5	Connection No. 6	
X6	Send-completed or receive-completed		Y6	Connection No. 7	
X7	Send error-detected		Y7	Connection No. 8	
X8	Send-completed or receive-completed	Connection No. 2 fixed buffer communications	Y8	Connection No. 1	Open request
X9	Send error-detected		Y9	Connection No. 2	
XA	Send-completed or receive-completed		YA	Connection No. 3	
XB	Send error-detected		YB	Connection No. 4	
XC	Send-completed or receive-completed		YC	Connection No. 5	
XD	Send error-detected		YD	Connection No. 6	
XE	Send-completed or receive-completed		YE	Connection No. 7	
XF	Send error-detected		YF	Connection No. 8	
X10	Connection No. 1	Open completed	Y10	Unused	
X11	Connection No. 2		Y11		
X12	Connection No. 3		Y12		
X13	Connection No. 4		Y13		
X14	Connection No. 5		Y14		
X15	Connection No. 6		Y15		
X16	Connection No. 7		Y16		
X17	Connection No. 8		Y17		COMM, ERR LED OFF
X18	Open error-detected	Y18	Unused		
X19	Initial-completed	Y19	Initial request		
X1A	Initial error-detected	Y1A	Unused		
X1B	Unused	Y1B	Unused		
X1C		Y1C	Buffer memory channel switching		
X1D		Y1D	Unused		
X1E		Y1E			
X1F		Watchdog timer error-detected	Y1F		

IMPORTANT

Since the device numbers indicated as "unused" in Table 3.4 are used by the system, the user must not use them.

If used by the user, normal operation cannot be guaranteed.

3.5.1 Details of I/O signals

The following explains the ON/OFF timing and conditions of the I/O signals shown in Table 3.4.

SA() shows the device number that corresponds to Table 3.4.

- (1) Send-completed or receive-completed signal (X0, X2, X4, X6, X8, XA, XC and XE)

This signal is used for communications using fixed buffer.

This signal is not used for communications using random access buffer and read/write of data in the PC CPU.

When fixed buffer is used for sending data, this signal is used as a send-completed signal.

When fixed buffer is used for receiving data, this signal is used as a receive-completed signal.

(a) When using this signal as a send-completed signal

- 1) When a send request signal (Y0 to Y7) turns ON, data is transmitted.
- 2) A node which received data sends a response to the AJ71E71.
- 3) When a response is sent from the node, the send-completed signal turns ON.
- 4) When a request to send signal (Y0 to Y7) turns OFF, a send-completed signal is turned OFF, too.
- 5) When the completion code of a response from other node is other than 00H, the send-completed signal does not turn ON.

Send error-detected signal (X1, X3, X5, X7, X9, XB, XD, and XF) turns ON.

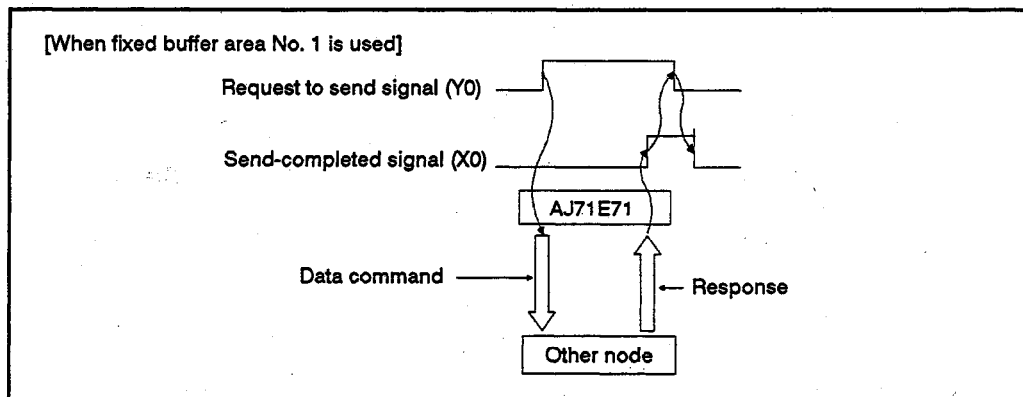

(b) When using this signal as a receive-completed signal

- 1) When the AJ71E71 receives data from a communicating node, this signal turns ON.
- 2) When reading received data to the PC CPU using the FROM instruction, this signal can be used for handshaking.
- 3) After reading received data using the FROM instruction, a receive-completed confirmation signal (Y0 to Y7) turns ON.

A response is sent to a node which transmitted data.

- 4) The receive-completed signal turns OFF automatically after sending a response to a node.
- 5) When error data is transmitted from a node, the receive-completed signal does not turn ON.

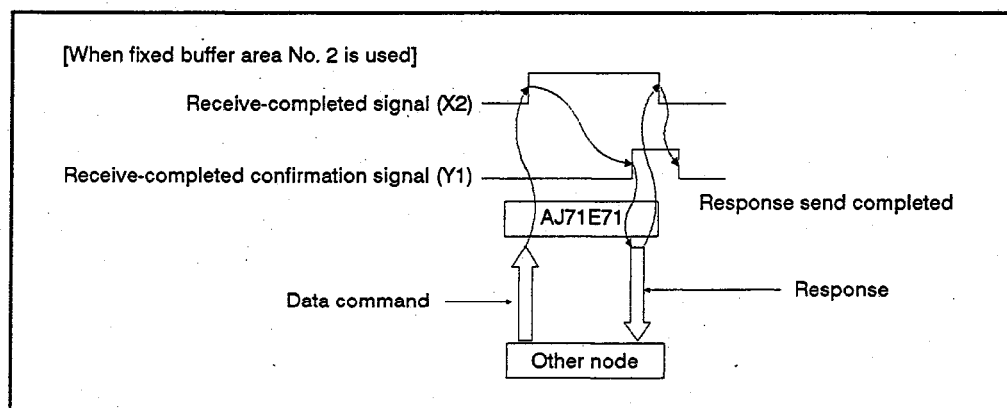

(2) Send error-detected signal (X1, X3, X5, X7, X9, XB, XD, and XF)

This signal is used for communications using fixed buffer.

This signal is not used for read/write of data in the PC CPU and for the communications using random access buffer.

- (a) When a response is not sent from a communicating node after data transmission using fixed buffer within the response watchdog timer value (Section 5.2.1), a send error-detected signal turns ON.
- (b) When ACK is not sent after data transmission with fixed buffer using the TCP connection, specified retry processing (Section 5.2.1) is executed, and then, send error-detected signal turns ON.
- (c) When the completion code of the response from a communicating node after data transmission using fixed buffer is other than 00H, a send error-detected signal turns ON.
- (d) When a request to send signal (Y0 to Y7) of fixed buffer turns OFF, a send error-detected signal is turned OFF, too.

(3) Connection open-completed signal (X10 to X17)

- (a) When an open request signal (Y8 to YF) of each connection is turned ON with a sequence program, communications parameters are checked, and the open processing is executed.

And then, when the open processing is executed normally, an open-completed signal (X10 to X17) turns ON.

- (b) When an open request signal is turned ON and the open processing is not executed normally, an open error-detected signal (X18) turns ON.

The connection open-completed signal does not turn ON in this case.

- (c) Data communications (fixed buffer communications, random access buffer communications, and read/write of data in the PC CPU) is enabled only with the node(s) for which the connection open-completed signal (X10 to Y17) is turned ON.

- (d) The ON/OFF states of the connection open-completed signal (X10 to X17) can be confirmed by the LEDs (BUF1 to BUF8) on the front of the AJ71E71.

- (e) When an open request signal is turned OFF with a sequence program, the connection open-completed signal (X10 to X17) turns OFF.

The connection open-completed signal turns OFF also in the following cases.

- 1) When the TCP time out error occurs. (Refer to Section 5.3.2.)
- 2) When the CLOSE or ABORT instruction is received from a communicating node. (Refer to Section 5.3.2.)
- 3) When a response watchdog timer error occurs. (Refer to Section 5.3.2.)

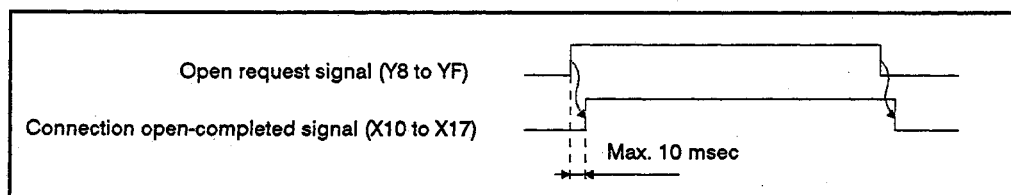

(4) Open error-detected signal (X18)

- (a) When an open request signal (Y8 to YF) of each connection is turned ON by the sequence program, communications parameters are checked. The error-detected signal turns ON.

- (b) When an open request signal (Y8 to YF) is turned ON, and the open processing is not executed normally, an open error-detected signal turns ON.

- (c) When an open error-detected signal turns ON, read an open error code storage area (buffer addresses 93, 103 and 113...163) in the communications state storage area. This enables the connection No. and the error description of the current error to be monitored.
- (d) The open error-detected signal (X18) turns OFF by turning OFF the open request signal (Y8 to YF) of the connection in which an open error is occurring.
- (e) When several open errors occur, all corresponding open request signals must be turned OFF to turn OFF the open error-detected signal (X18).

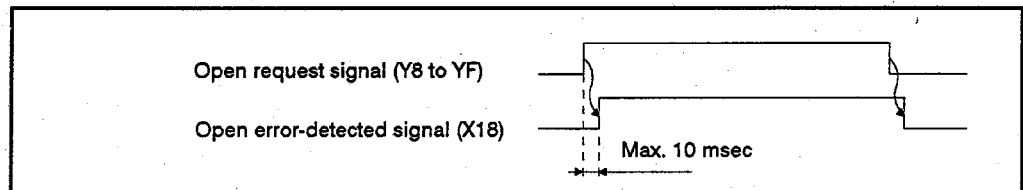

- (5) Initial-completed signal (X19)
 - (a) When an initial request signal (Y19) is turned ON with a sequence program, the initial parameters are checked, and the initial processing is executed.
 And then, when the initial processing is executed normally, the initial-completed signal (X19) turns ON.
 - (b) When the initial processing is not executed normally, the initial error-detected signal (X1A) turns ON.
 The initial-completed signal (X19) does not turn ON in this case.
- (6) Initial error-detected signal (X1A)
 - (a) When the initial request signal (Y19) is turned ON, and when the initial processing is not executed normally, the initial error-detected signal (X1A) turns ON.
 - (b) When initial error-detected signal (X1A) turns ON, read an initial error code storage area (buffer memory 80) in the communications state storage area (See Section 5.2.3.), and then, the error description can be monitored.
 - (c) The initial error-detected signal (X1A) turns OFF by turning OFF the initial request signal.
- (7) WDT error-detected signal (X1F)

When a WDT error is detected by the self-diagnostic function of the AJ71E71, a WDT error-detected signal (X1F) turns ON.

(8) Request to send or receive-completed confirmation signal (Y0 to Y7)

This signal is used for communications using fixed buffer.

This signal is not used for communications using random access buffer and read/write of data in the PC CPU.

When fixed buffer is used for sending, this signal can be used as a request to send signal.

When fixed buffer is used for receiving, this signal can be used as a receive-completed confirmation signal.

(a) When this signal is used as a request to send signal

- 1) The AJ71E71 transmits data to a node specified by the communications parameter by turning ON the request to send signal (Y0 to Y7) with a sequence program.
- 2) A response is sent back from the node after data transmission, and a send-completed signal (X0 when fixed buffer No.1 is used) turns ON. And the send is completed.

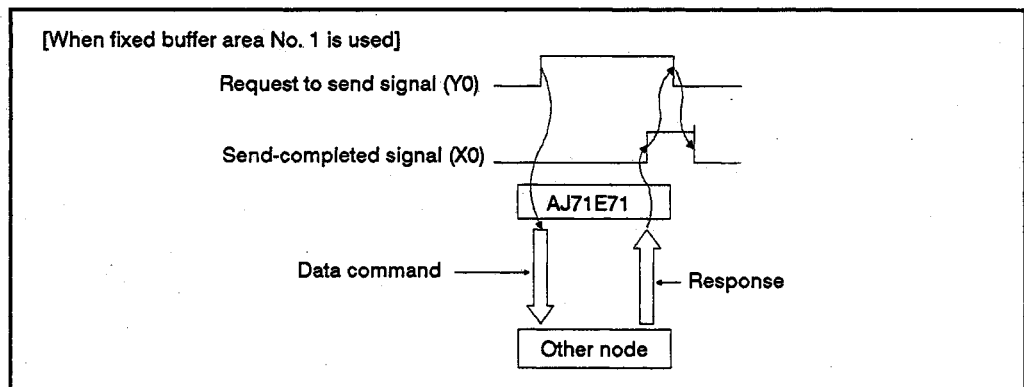

(b) When using this signal as a receive-completed signal

- 1) After the AJ71E71 receives data from a node, a receive-completed signal (X2 when fixed buffer No. 2 is used) turns ON.
- 2) The sequence program confirms the receive-completed signal (X2 when fixed buffer No. 2 is used) ON state.

Then, when the receive-completed confirmation signal (Y0 to Y7) turns ON, the AJ71E71 sends a response to the communicating node.

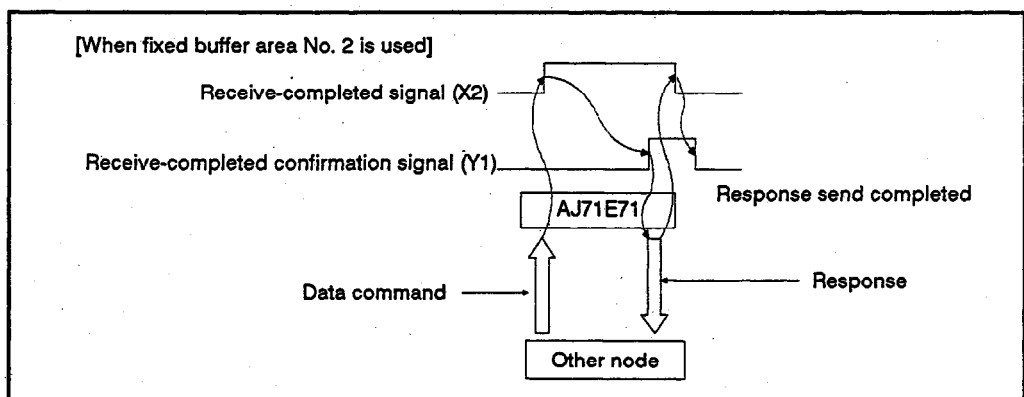

(9) Open request signal (Y8 to YF)

- (a) This signal is turned ON so that the AJ71E71 can execute data communications (fixed buffer communications, random access buffer communications and data read/write in the PC CPU) with other nodes.
- (b) The communications parameters are checked when an open request signal (Y8 to YF) of each connection is turned ON by a sequence program.

If the check result is normal, the open processing is executed.

When an error is detected, the open error-detected signal (X18) turns ON.

- (c) When the open processing is executed normally when an open request signal is turned ON, the connection open-completed signal (X10 to X17) turns ON.

When an error is detected, the open error-detected signal (X18) turns ON.

- (d) The open error-detected signal (X18) turns OFF, when the open request signal (Y8 to YF) is turned OFF. When several connections are causing errors, turn OFF all the open request signals for those connections.

When the open error-detected signal (X18) is turned OFF, the open error code storage area in the communications state storage area is also cleared.

Therefore, be sure to read the open error code storage area (buffer addresses 93, 103 and ...163) before turning OFF the open request signal when an error occurs.

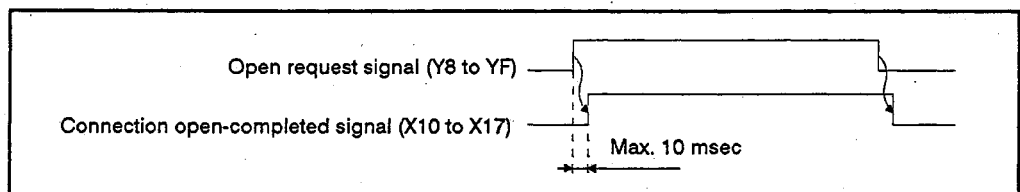

(10) The 'COM.ERR' LED OFF signal (Y17)

This signal is used to turn off the 'COM.ERR' LED that turns on when a communications error occurs.

The 'COM.ERR' LED turns off by turning ON the turn OFF signal (Y17) with a sequence program.

While the turn OFF signal (Y17) is ON, the turn OFF processing is executed.

(11) Initial request signal (Y19)

- (a) This signal is used to initialize the AJ71E71 before starting data communications.
- (b) The initial parameters are checked by turning ON the initial request signal (Y19) with a sequence program.

If the check result is normal, the initial processing is executed.

When an error is detected, the initial error-detected signal (X1A) turns ON.

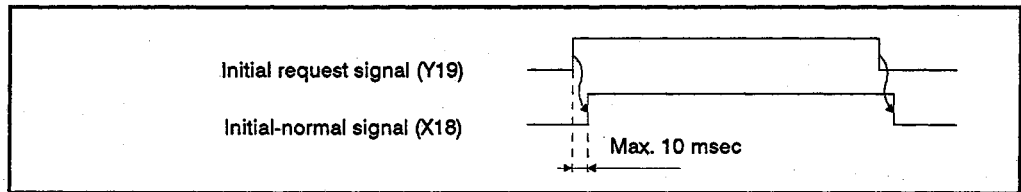

- (c) When the initial processing is executed normally when the initial request signal (Y19) is turned ON, the initial-completed signal (X19) turns ON.

And then, when an error is detected, the initial error-detected signal (X1A) turns ON.

(12) Buffer memory channel switching signal (Y1C)

This signal is used to specify a channel to be used with buffer memory.

Before doing read/write with the AJ71E71 buffer memory by the FROM/TO instruction of a sequence program, this signal is turned ON or OFF with a sequence program.

OFF : Channel 0 becomes valid.

ON : Channel 1 becomes valid.

3. SPECIFICATIONS

3.6 Buffer Memory Map

The following explains the AJ71E71 buffer memory used for data communications with a PC CPU.

As shown in the figure below, the memory map of AJ71E71 is composed of an initial processing parameter area, a communications parameter area, a communications state storage area, an Ethernet address setting area, fixed buffer areas and random access buffer areas.

Address (decimal)		See Section	
0	Initial processing parameter area (16 words)	5.2	
to 16			
16	Communications parameter area (64 words)	5.3.1	
to 80			
80	Initial processing status storage area (6 words)	5.2.3	
to 86			
86	Unused	—	
to 89			
89	Communications line status storage area (80 words)	5.3.3	
to 169			
169	Error log area (11 words)	5.3.3	
to 180			
180	Unused	—	
to 512			
512	Fixed buffer No.1 (1 K words)	Fixed buffer No.5 (1 K words)	6
to 1536	Fixed buffer No.2 (1 K words)	Fixed buffer No.6 (1 K words)	
1536	Fixed buffer No.3 (1 K words)	Fixed buffer No.7 (1 K words)	
to 2560	Fixed buffer No.4 (1 K words)	Fixed buffer No.8 (1 K words)	
2560	Fixed buffer No.3 (1 K words)	Fixed buffer No.7 (1 K words)	
to 3584	Fixed buffer No.4 (1 K words)	Fixed buffer No.8 (1 K words)	
3584	Fixed buffer No.4 (1 K words)	Fixed buffer No.8 (1 K words)	
to 4608	Fixed buffer No.4 (1 K words)	Fixed buffer No.8 (1 K words)	
4608	Random access buffer (3 K words)	Random access buffer (3 K words)	7
to 7679	Random access buffer (3 K words)	Random access buffer (3 K words)	

Channel 0 (Y01C is turned OFF)

Channel 1 (Y01C is turned ON.)

4. PRE-OPERATION SETTINGS

This section explains the pre-operation settings of the AJ71E71.

4.1 Pre-Operation Settings

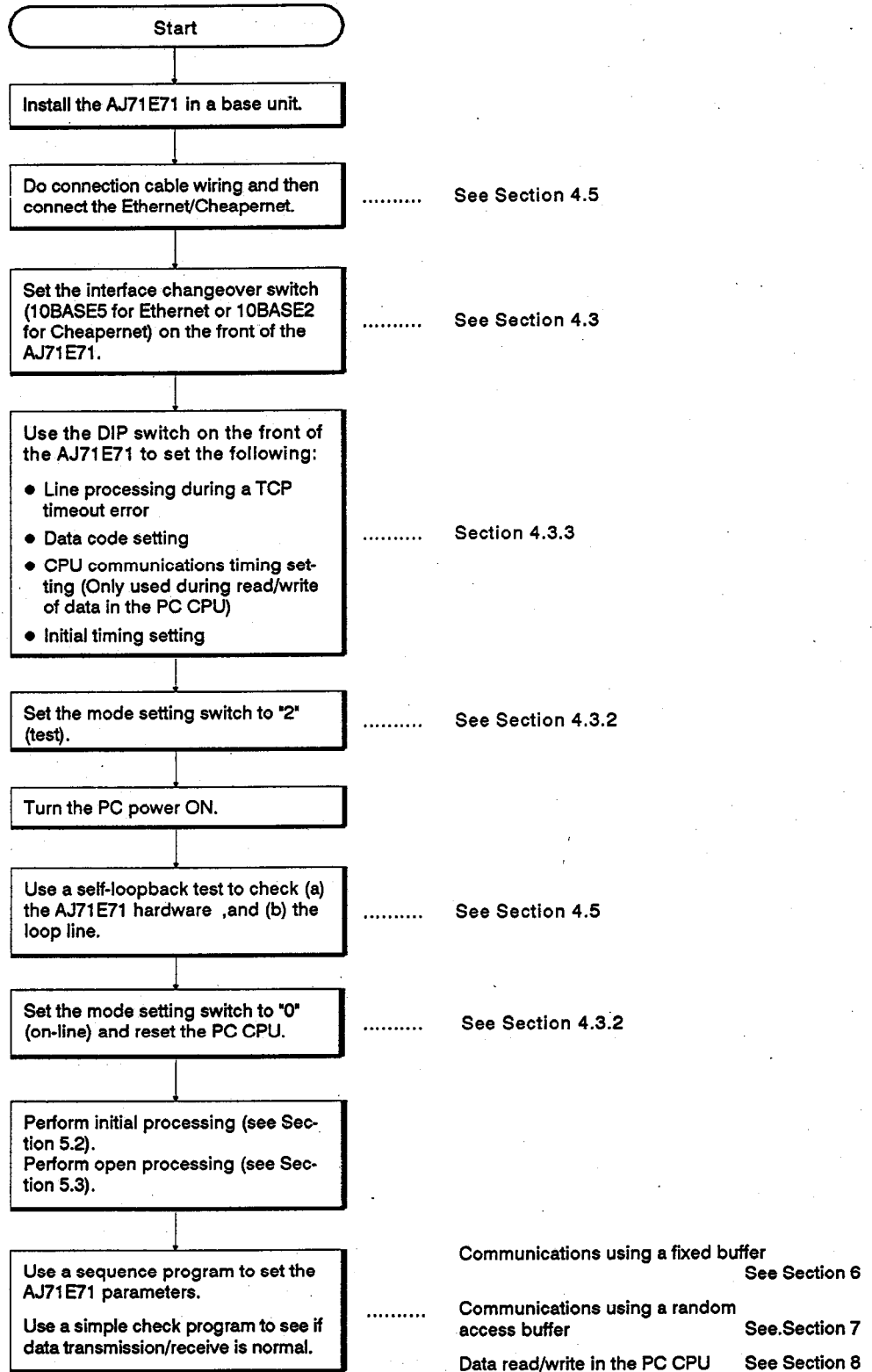

4.2 Handling Instructions

- (1) Protect the AJ71E71 and its terminal block from impact.
- (2) Do not touch or remove the printed circuit board from the case.
- (3) Do not allow metal particles or wire offcuts to enter the AJ71E71.
- (4) Tighten the module mounting and terminal screws as specified below.

Screw	Tightening Torque kg.cm
Power supply cable connection terminal screw (M4)	10 to 14
Module mounting screws (optional) (M4)	8 to 12

Never install the system in the following environments:

- Locations where ambient temperature is outside the range 0 to 55°C (32 to 131°F).
- Locations where ambient humidity is outside the range of 10 to 90%RH.
- Locations where dew condensation takes place due to sudden temperature changes.
- Locations where there are corrosive gasses and combustible gasses.
- Locations where there is a high level of conductive powder, such as dust and iron filings, oil mist, salt, and organic solvent.
- Locations exposed to the direct rays of the sun.
- Locations where strong power and magnetic fields are generated.
- Locations where vibration and shock are directly transmitted to the main unit.

4.3 Nomenclature

AJ71E71 nomenclature and settings are explained below.

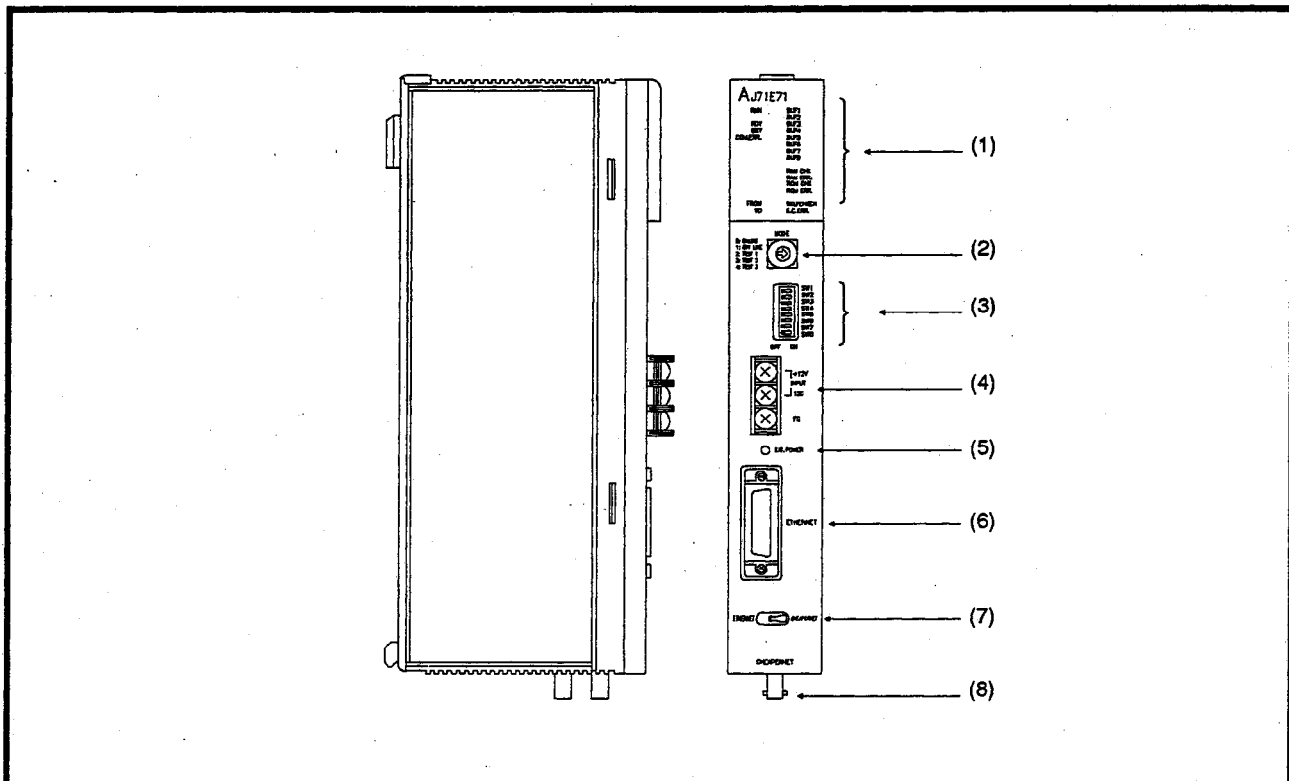

Number	Name	Description	See Section
(1)	Display LED	Indicates operating states, data communications displays, and error descriptions Each LED reflects various aspects of the AJ71E71 operation, so ON/OFF states cannot be directly referred to in the same meaning. The ON/OFF state has different meanings for different LEDs.	4.3.1
(2)	Mode setting switch	This selects the operating mode for online, offline, and self-diagnostic tests. It is factory-set at "0" (online).	4.3.2
(3)	Communications state setting switch	This sets the conditions for starting, communications processing, communications code classifications, and TCP timeout error processing. SW1 to SW8 are factory-set at OFF.	4.3.3
(4)	External power supply terminal	When used with a 10BASE5 (Ethernet), the power to the transceiver is supplied here. This is not used with a 10BASE2 (Cheapernet).	2.1.2
(5)	External power supply input confirmation	When used with a 10BASE5 (Ethernet), this lamp confirms whether or not power is supplied to the transceiver. This is not used with a 10BASE2 (Cheapernet).	2.1.2
(6)	10BASE5 (Ethernet) connector	This connects an AJ71E71 to a 10BASE5 (Ethernet).	2.1.2
(7)	10BASE5 (Ethernet)/10BASE2 (Cheapernet) changeover switch	This changes the interface between an AJ71E71 and a 10BASE5 (Ethernet) or 10BASE2 (Cheapernet). It is factory-set at the 10BASE5 (Ethernet) side	—
(8)	10BASE2 (Cheapernet) connector	This connects an AJ71E71 to a 10BASE2 (Cheapernet).	2.1.2

4. PRE-OPERATION SETTINGS

MELSEC-A

4.3.1 LED signal names and indicator descriptions

The following table gives the signal names and indicator descriptions of the display LEDs on the upper front side of an AJ71E71.

Table 4.1 LED Indicator Description List

LED Location Chart	LED Name	LED Indicator Description	LED ON	LED OFF
	RUN	Normal operation	Normal	Error
	RDY	Communications preparation completed	This goes ON at the beginning of an online operation.	
	BSY	Communications processing is being executed	This goes ON during communications with a node.	
	COM. ERR	Communications error detection	Communications error	Normal
	FROM	Data is being read	This goes ON during a FROM instruction.	
	TO	Data is being written	This goes ON during a TO instruction.	
	BUF 1	Connection status of a No. 1 connection	Open-completed	Closed
	BUF 2	Connection status of a No. 2 connection		
	BUF 3	Connection status of a No. 3 connection		
	BUF 4	Connection status of a No. 4 connection		
	BUF 5	Connection status of a No. 5 connection		
	BUF 6	Connection status of a No. 6 connection		
	BUF 7	Connection status of a No. 7 connection		
	BUF 8	Connection status of a No. 8 connection		
	RAM. CHK	RAM test is being executed	This goes ON during a RAM test.	
	RAM. ERR	RAM error detection	RAM error	Normal
	ROM. CHK	ROM test is being executed	This goes ON during a ROM test	
	ROM. ERR	ROM error detection	ROM error	Normal
	SELF CHK	A self-loopback test is being executed	This goes ON during a self-loopback test.	
	S.C. ERR	Self test error detection	Self-loop-back error	Normal

- (1) If a WDT error causes the RUN LED to go OFF after power is turned ON, the WDT error detection signal (X1F) goes ON.
- (2) The RDY LED goes ON just after the beginning of an online mode operation. (The mode setting switch is set at 0.) When the initial timing setting (SW8) of a communications condition setting switch is in the normal mode, this LED goes ON about 20 seconds after an online mode operation is started.

4. PRE-OPERATION SETTINGS

MELSEC-A

- (3) As indicated above, BSY "communications processing is being executed" can be defined in the following ways:
- (a) Time until timeout or until receiving a response after transmitting a command
 - (b) Time until timeout or until transmitting a response after receiving a command
- (4) The connection status of the BUF1 to BUF8 LEDs means the connection status of a line with a node set by a communications parameter.

The ON/OFF connection states of the open-completed signals (X10 to X17) can be confirmed by these LEDs.

After which, only open-completed connections can perform data communications.

4.3.2 Operating mode settings

Table 4.2 Description List of Operating Mode Settings

Setting Number	Setting Name	Setting Description
0	Online	Communications with a node is done in the usual operating mode.
1	Offline	The AJ71E71 is disconnected from the network.
2	Test 1	A self-diagnostic test is done using a self-loopback test.
3	Test 2	A RAM test is done.
4	Test 3	A ROM test is done.
5		Unused
6		
7		
8		
9		
A		
B		
C		
D		
E		
F		

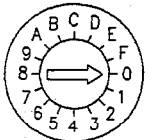

POINT

If the operating mode is changed, switch the mode setting switch. Then, reset the PC CPU.

When it is reset, an operating mode selection is started.

4.3.3 Communications Condition Settings

Table 4.3 Description List of Communications Condition Settings

Switch	Setting Item	Setting Description	Factory Setting
SW1	Line processing selection during a TCP timeout error	If a TCP timeout error occurs, line processing is selected: OFF: The line is closed by the TCP timeout error. ON: Even a the TCP timeout error occurs, the line is not closed.	OFF
SW2	Data code setting	A code classification for data communications with a node is selected: OFF : Communications is done in binary code. ON: Communications is done in ASCII code.	OFF
SW3	Unused		OFF
SW4			OFF
SW5			OFF
SW6			OFF
SW7	CPU communication's timing setting	When a PC CPU is in the RUN state, data write enable/disable from a node is selected: OFF: When the PC CPU is in the RUN state, a write operation from the node is disabled. ON: When the PC CPU is in the RUN state, a write operation from the node is enabled.	OFF
SW8	Initial timing setting	Timing to start initial processing is selected. OFF: Quick start (starting without a delay time.) When communications is made by a single network, this is set. ON: Normal start (starting 20 seconds after a delay time.) When composed of several networks, this is set.	OFF

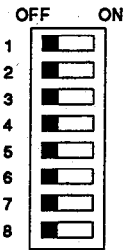

(1) Line processing selection by a TCP timeout error

If the TCP protocol is used (even if specified retry processing is done) and an ACK is not sent, a TCP timeout error occurs.

At this time, the connection processing is selected.

(2) Data code setting

When data communications is done with a node, a data code classification (ASCII or binary) is selected.

(3) Initial timing setting

When the TCP/IP protocol is used, the closed connection is frozen for about 20 seconds.

When a system starts, the time needed for startup is automatically set.

The time between the initial processing request signal (Y19) coming ON and the initial-completed signal (X19) coming ON changes in accordance with this setting.

POINT

Make sure the power supply to the AJ71E71 is OFF when the communications condition setting switch is set.

4.4 Connecting to the Network

The method for connecting an AJ71E71 to a 10BASE5 (Ethernet) or 10BASE2 (Cheapernet) is given below.

4.4.1 Connection to a 10BASE5 (Ethernet)

The following explains how to connect an AJ71E71 to a 10BASE5 (Ethernet) network.

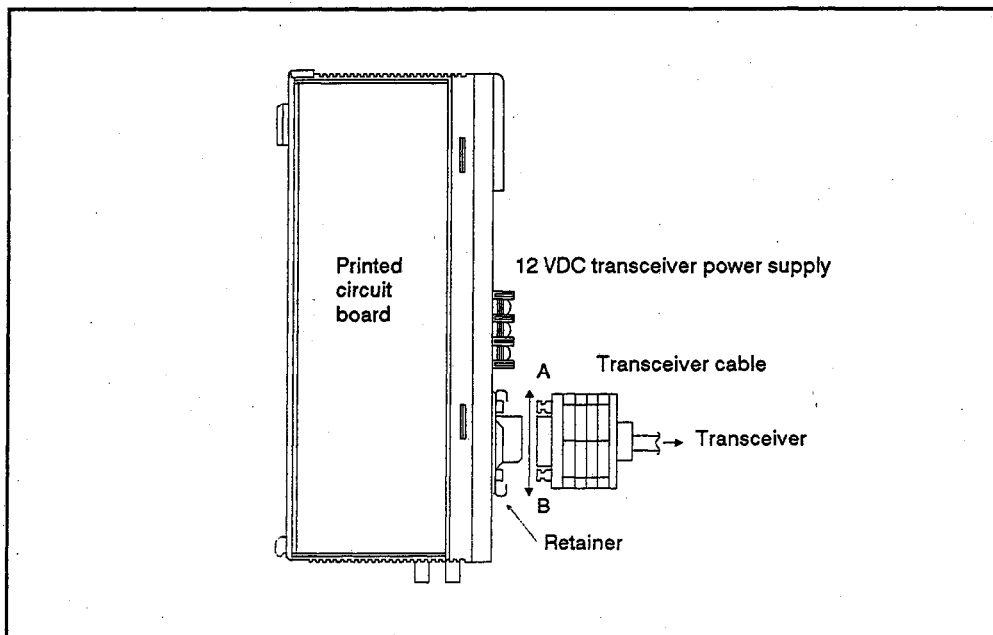

Fig. 4.1 Connecting a Transceiver Cable

How to connect a transceiver cable

- (1) Slide the retainer towards "A" in the figure.
- (2) Insert the connector of a transceiver cable connector so that the cable is fully secured by the retainer.
- (3) Slide the retainer towards "B" in the figure.
- (4) Make sure the transceiver cable is securely locked in place.
- (5) Input power to the transceiver.

(Do not connect the cable while the power supply is ON.)

IMPORTANT

When connecting transceiver cables, make sure that the cables are 50 mm or more from both the power line and the large current main ladder; otherwise there will be a malfunction.

REMARK

Consult a specialist about terminal processing of an Ethernet cable and connecting a trunk line cable.

4.4.2 Connecting to a 10BASE2 (Cheapernet)

The following explains how to connect an AJ71E71 to a 10BASE2 (Cheapernet) network.

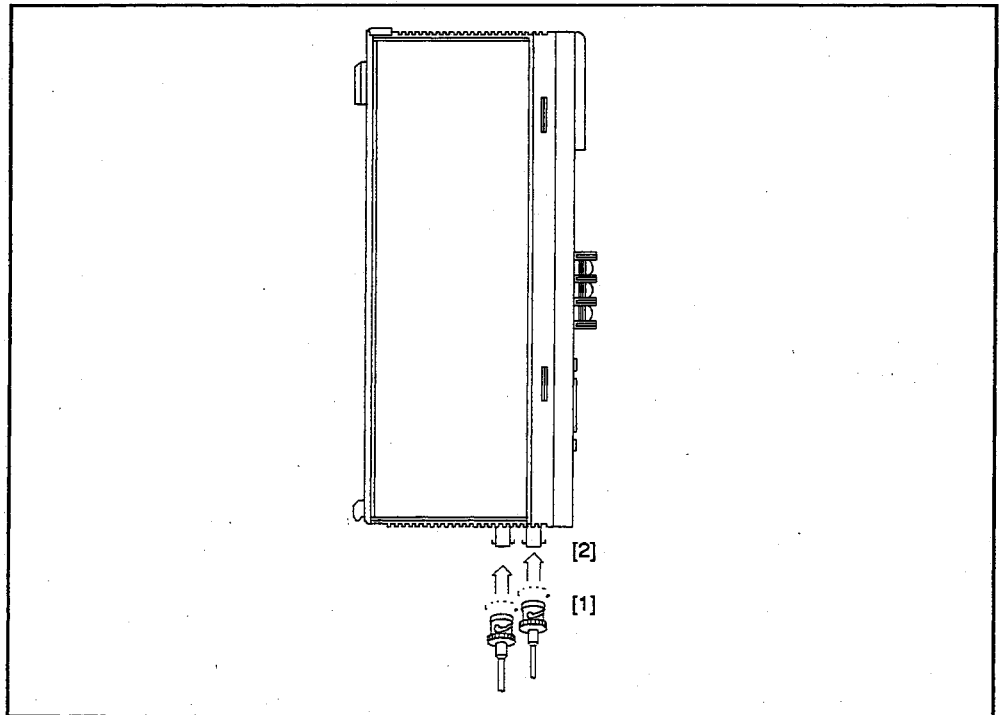

Fig. 4.2 Connecting a Cheapernet Coaxial Cable

How to connect a Cheapernet coaxial cable

- (1) Make sure the connector [1] and the slot [2] line up. Then, push the connector in.
- (2) While pushing the connector, rotate it 1/4 turn to the right.
- (3) Keep rotating the connector until it locks in place.
- (4) Make sure the connector is securely fixed.

POINT

The coaxial cable has a constant allowable bend radius.

When connecting a Cheapernet coaxial cable, a space that is larger than the allowable bend radius of a coaxial cable is needed with an AJ71E71.

Find out the allowable bend radius of the coaxial cable from the manufacturer.

IMPORTANT

When connecting transceiver cables, make sure that the cables are 50 mm or more from both the power line and the large current main ladder; otherwise there will be a malfunction.

REMARK

Connection of a coaxial cable connector

The following explains how to connect a BNC connector (coaxial cable connector plug) to a cable.

(1) Configuration of a BNC connector and a coaxial cable

Figure 4.3 shows the configurations of a BNC connector and a coaxial cable.

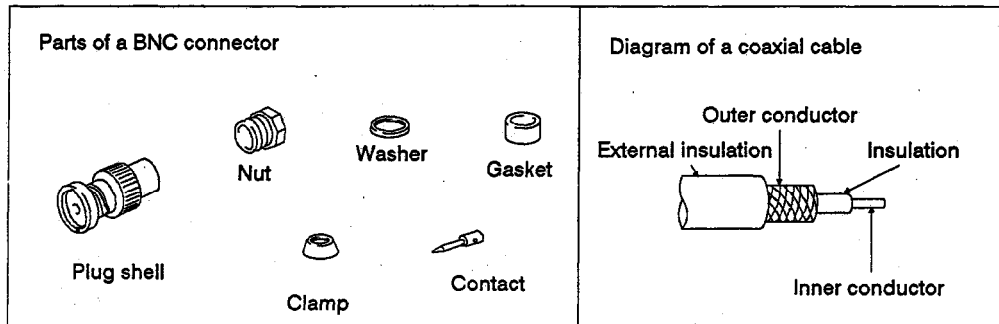
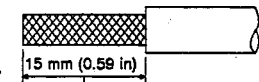

Fig. 4.3 Configurations of a BNC Connector and a Coaxial Cable

(2) How to connect a BNC connector to a coaxial cable

The following describes how to connect a BNC connector and a coaxial cable.

(a) Remove the external insulation of the coaxial cable as shown on the right. Take care not to damage the outer conductor.



How to remove the external insulation

(b) As shown to the right, put the nut, washer, gasket, and clamp on the coaxial cable. Then, loosen the outer conductor.

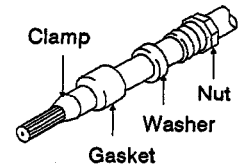

(c) Cut the outer conductor, the insulator, and the inner conductor as shown on the right. However, cut the outer conductor just enough to cover the tapering part of the clamp. Then, cover the clamp with it.

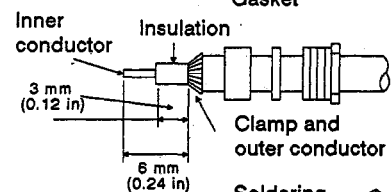

(d) Solder the contact to the inner conductor.

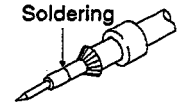

(e) Insert the contact assembly of (d) into the plug shell.

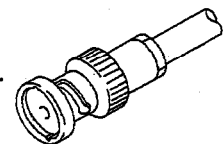

Finally, put the nut on the plug shell.

POINT

When soldering the inner conductor to the contact, pay close attention to the following:

- (1) When soldering, make sure the solder does not swell.
- (2) There should be no space between the contact and the cable insulation. Also, make sure the contact does not cut into the insulation.
- (3) Do the soldering quickly so that an insulation is not altered in any way.

4.5 Self-Diagnostic Tests

4.5.1 Self-loopback test

The following explains the self-loopback test for checking the hardware containing the communications ladder of an AJ71E71.

The AJ71E71 transmits a test message to itself in the self-loopback test and receives this test message through the network.

The AJ71E71 then examines whether or not the received test message is the same as a transmitted test message.

The self-loopback test (which takes about five seconds) is explained below.

How to do a self-loopback test

- 1) Connect the AJ71E71 to an Ethernet or a Cheapernet line.
- 2) Set the changeover switch of the 10BASE5 (Ethernet) or 10BASE2 (Cheapernet).
- 3) Set the operating mode setting rotary switch on the front of the AJ71E71 at "2".
- 4) Set the RUN/STOP keyswitch of the PC CPU at STOP.
- 5) Reset the PC CPU. Then, start the self-loopback test.

Make sure the SELF CHK LED goes ON.

Test results

- 1) When the SELF CHK LED goes OFF, the self-loopback test is completed.
- 2) Confirm the test result with the S.C.ERR LED.
Normal.....The S.C.ERR LED is OFF.
Faulty.....The S.C.ERR LED is ON.
- 3) The fault cause is one of the following:
Faulty AJ71E71 hardware
Faulty Ethernet or Cheapernet line
Incorrect setting of the changeover switch of the 10BASE5 (Ethernet) or 10BASE2 (Cheapernet)
Faulty 12 VDC external power supply (when testing a 10BASE5)

Post-test operation

Switch the operating mode setting rotary switch on the front of the AJ71E71 to the online mode or another test mode. Then, reset the PC CPU.

POINT

Even if a self-loopback test is done, if a node is online, the problem is not in the hardware.

Also, if a packet is interfered with in a line (because it collides with other packets), this test will not be completed within five-second time span.

After stopping data communications between nodes, do a self-loopback test.

4.5.2 RAM test

The following explains the RAM test for checking the RAM memory of an AJ71E71.

How to do a RAM test

- 1) Set the operating mode setting rotary switch on the front of the AJ71E71 at "3".
- 2) Set the RUN/STOP keyswitch of the PC CPU at STOP.
- 3) Reset the PC CPU. Then, start the RAM test.
Make sure the RAM CHK LED goes ON.

Test results

- 1) When the RAM CHK LED goes OFF, the RAM test is completed.
- 2) Confirm the test result with the RAM ERR LED.
Normal.....The RAM ERR LED is OFF.
Error.....The RAM ERR LED is ON.

Post-test operation

Switch the operating mode setting rotary switch on the front of the AJ71E71 to the online mode or another test mode. Then, reset the PC CPU.

4.5.3 ROM test

The following explains the ROM test for checking the ROM memory of an AJ71E71.

How to do a ROM test

- 1) Set the operating mode setting rotary switch of the front of the AJ71E71 at "4".
- 2) Set the RUN/STOP keyswitch of the PC CPU at STOP.
- 3) Reset the PC CPU. Then, start the ROM test.
Make sure the ROM CHK LED goes ON.

Test results

- 1) When the ROM CHK LED goes OFF, the RAM test is completed.
- 2) Confirm the test result with the ROM ERR LED.
Normal.....The ROM ERR LED goes OFF.
Erro.....The ROM ERR LED goes ON.

Post-test operation

Switch the operating mode setting rotary switch on the front of the AJ71E71 to the online mode or another test mode. Then, reset the PC CPU.

5. COMMUNICATING WITH OTHER NODES

5.1 Communicating with other nodes

To start communications between an AJ71E71 and any other node, initial processing and open processing need to be executed to establish a valid connection between the two. Communications are possible only between these nodes which have an established connection between them.

To end communications, close processing and end processing are executed. The connection between nodes is made invalid and all communication processings end.

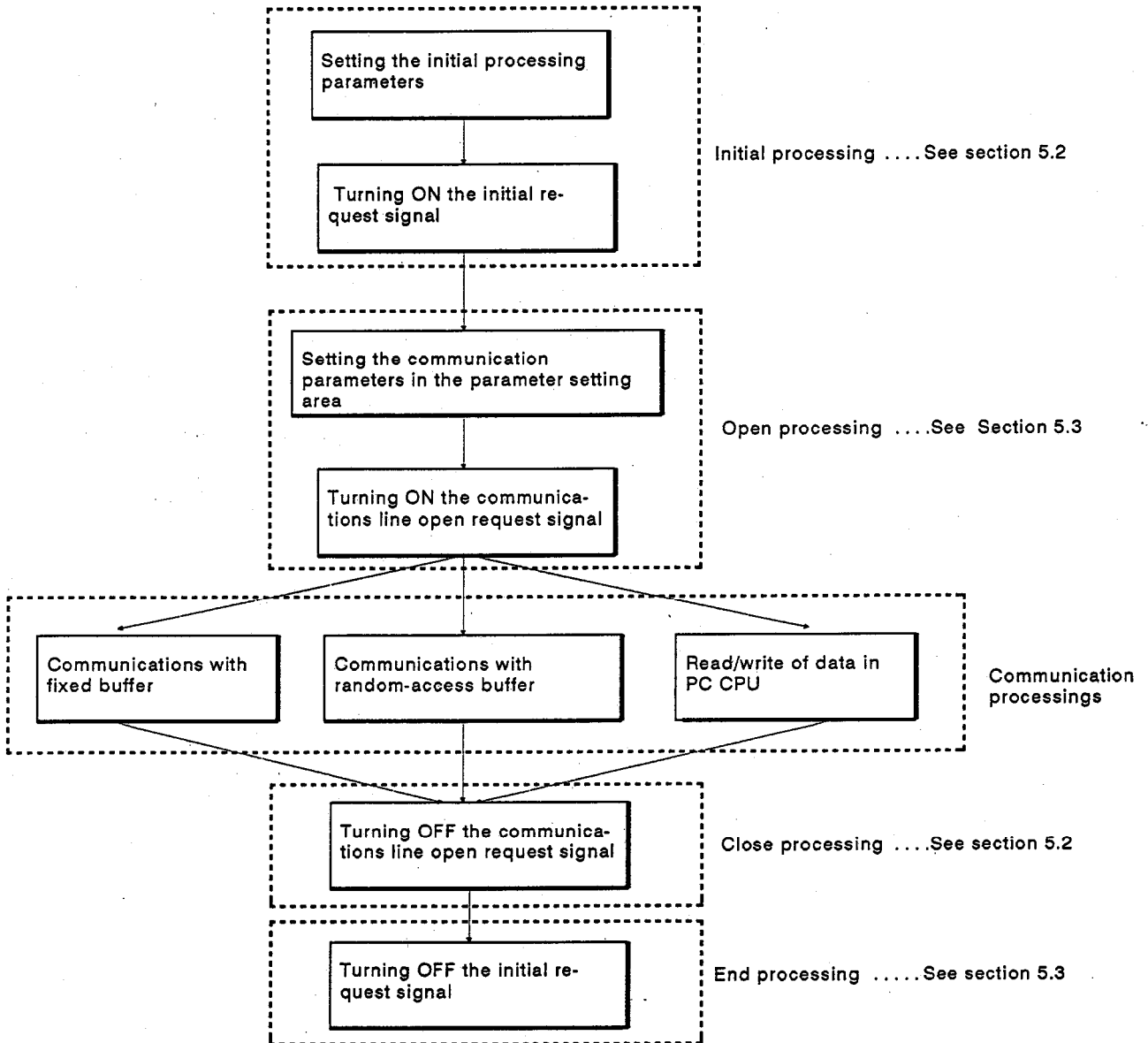

Fig. 5.1 Communicating with other nodes

POINTS

- (1) Open processing is required to open a valid communications line to a communicating node to perform communications with fixed buffer or random-access buffer or to perform read/write of data in the PC CPU. These three kinds of communications can be performed between nodes which are connected with an open communications line.
- (2) Open processing can be performed for up to eight nodes. However, when fixed buffer is used for both send and receive communications with one node, two buffer areas are needed. The number of communicating nodes accordingly decreases.

Initial processing must be completed before starting open processing.

5.2 Initial Processing

This section explains the initial processing of an AJ71E71.

5.2.1 Data for initial setting

The parameter setting area (buffer addresses 0 to 15) for doing initial processing is shown below.

Set a value determined by the network manager (network planner, the IP address manager, etc.) here.

Buffer Memory Address	Setting Description
0	IP address of the AJ71E71
1	
2	Unused
3	
4	
5	
6	
7	
8	
9	
10	TCP and ULP timeout value
11	TCP zero window timer value
12	TCP retransmission timer value
13	TCP completed timer value
14	IP assembly timer value
15	Response watching timer value

- (1) IP address of the AJ71E71 (2 words)

The IP address of AJ71E71 is set.

- (2) TCP and ULP timeout value (default = 15; setting time = set value x 2 seconds)

This timeout value sets the packet lifetime of the TCP.

This is the timer that is transferred in the parameter form during the opening of a TCP and during data transmission.

- (3) The TCP zero window timer value (default = 5; setting time = set value × 2 seconds)

When the send window size of a TCP becomes 0, a send window confirmation packet is retransmitted. This timer value sets the time.

- (4) The TCP retransmission timer value (default = 5; setting time = set value × 2 seconds) When ACK is not sent back, even if open data of TCP is transmitted, data is retransmitted. This timer value sets the time.

- (5) TCP completed timer value (default = 10; setting time = set value × 2 seconds)

When the self closes the connection of TCP, a counterpart station is closed. This value sets the time needed for the close processing of a counterpart station.

POINT

In the case of software package "H" and later versions, if it has not been possible to close the connection within the time set by the TCP completed timer value, RST processing is performed at the communicating node to forcibly execute close processing.

- (6) IP assembly timer value (default = 16; setting time = set value × 2 seconds)

When data split by the IP is received and the AJ71E71 waits for the next split data. This timer value sets this wait time.

- (7) Response watchdog timer value (default = 15; setting time = set value × 2 seconds)

When a command is transmitted, a response is sent back. This timer value sets the wait time.

REMARKS

- (1) The number of retries is determined by the following formula:

$$\text{Number of retries} = \frac{\text{TCP ULP timeout value}}{\text{TCP retransmission timer value}}$$

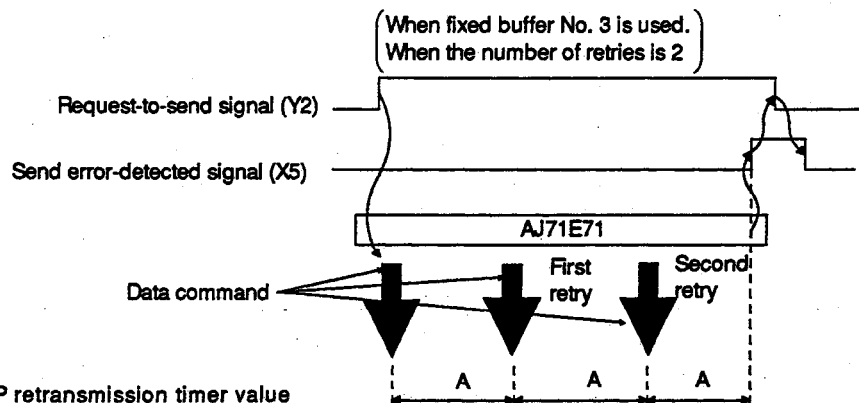

[A]: TCP retransmission timer value

After data is transmitted, if an ACK is not sent back, the data will be retransmitted. The retransmission timer value sets this retransmission time.

- (2) Use data for the initial setting to set the IP address. Use other data as a default.

5.2.2 Initial processing procedures

This section explains the initial processing procedures used with an AJ71E71.

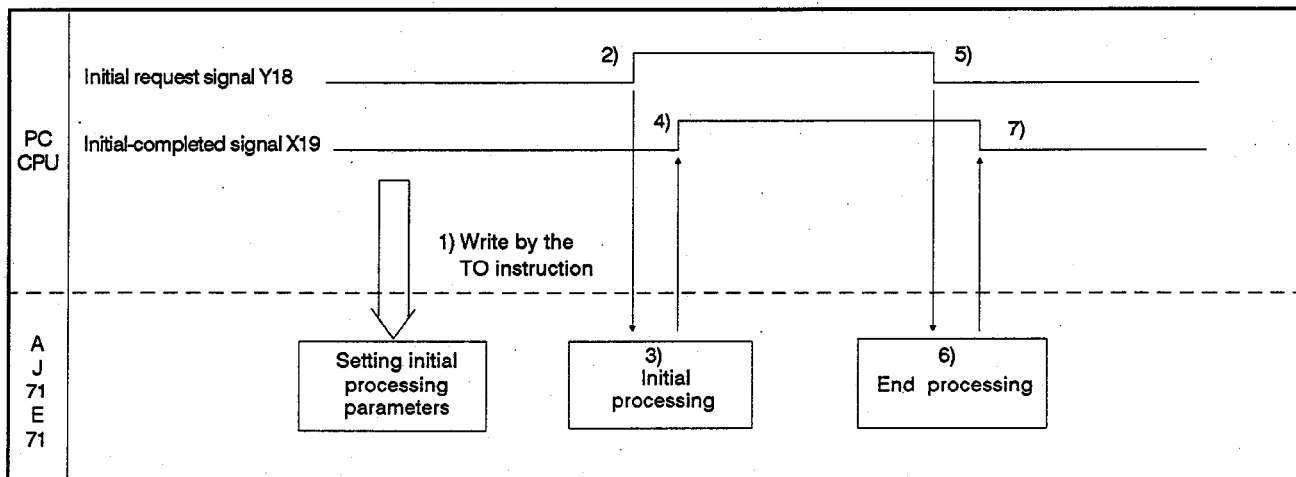

Fig. 5.2. Initial Processing

- (1) The initial processing parameters are written by the T0 instruction of a sequence program.
- (2) The initial processing request signal (Y18) is turned ON.
- (3) Initial processing for the AJ71E71 is performed.
- (4) When initial processing is completed, the initial-completed signal (X19) turns ON.

When an error is detected during initial processing, the initial error-detected signal (X1A) turns ON.

Check the initial error code (buffer address 80) and retry initial processing.

- (5) The initial processing request signal (Y18) is turned OFF.

This signal is turned OFF when the initial error-detected signal (X1A) is turned ON or when initial processing is discontinued.

- (6) Initial processing for the AJ71E71 is completed.
- (7) When initial processing is completed, the initial-completed signal (X19) or, when an error is detected during initial processing, the initial error-detected signal (X1A) is turned OFF.

All open lines are closed.

5.2.3 Initial processing state storage area

This section deals with the area (buffer addresses 80 to 88) where the initial processing state of the AJ71E71 is stored.

(1) Initial error code

- (a) An occurring error code is stored when initial processing is executed.
- (b) Section 9.2.1 gives details about the initial processing error code.
- (c) The error code is stored as a binary value.
- (d) The error code will be cleared in the following cases:
 - 1) When the PC PCU is reset, or PC power is turned OFF
 - 2) When writing "0" in an initial error code (address 80 of a buffer memory) using a sequence program

Word Address	Communications Status
80	Initial error code
81	AJ71E71 address setting monitoring (L) to (H)
82	
83	AJ71E71 Ethernet address setting monitoring (L) to (H)
84	
85	

(2) AJ71E71 IP address storage

- (a) The AJ71E71 address set when initial processing is executed is stored.
- (b) The AJ71E71 address is stored as a binary value.

Example: The following shows the data storage state; the IP address is A2009C0H (162.0.9.192).

Address	Buffer memory
81	09C0H
82	A200H

(3) AJ71E71 Ethernet address storage

- (a) The physical address of an AJ71E71 is read from ROM and is stored in this area.

Because the physical address of the Ethernet is written in ROM, it cannot be changed.

- (b) The AJ71E71 Ethernet address is stored as a binary value.

5.2.4 Sample Initial processing program

This section shows the sequence program for the initial processing of an AJ71E71.

Example: The AJ71E71 is installed in the "0" slot of a main base.

The initial processing parameters are as follows:

- (a) The IP address of the AJ71E71 is "A20009C0H (162.0.9.192)".
- (b) The TCP ULP timeout value is a default "15" (15 × 2=30 seconds).
- (c) The TCP zero window value is a default "5" (5 × 2=10 seconds).
- (d) The TCP retransmission timer value is a default "5" (5 × 2=10 seconds).

As a result, the retry count is 15/5 = 3 times.

- (e) The TCP completion timer value is a default "10" (10 × 2=20 seconds).
- (f) The IP assembly timer value is a default "16" (16 × 2=32 seconds).
- (g) The response watch dog timer value is a default "30" (30×2=60 seconds).

Initial processing program

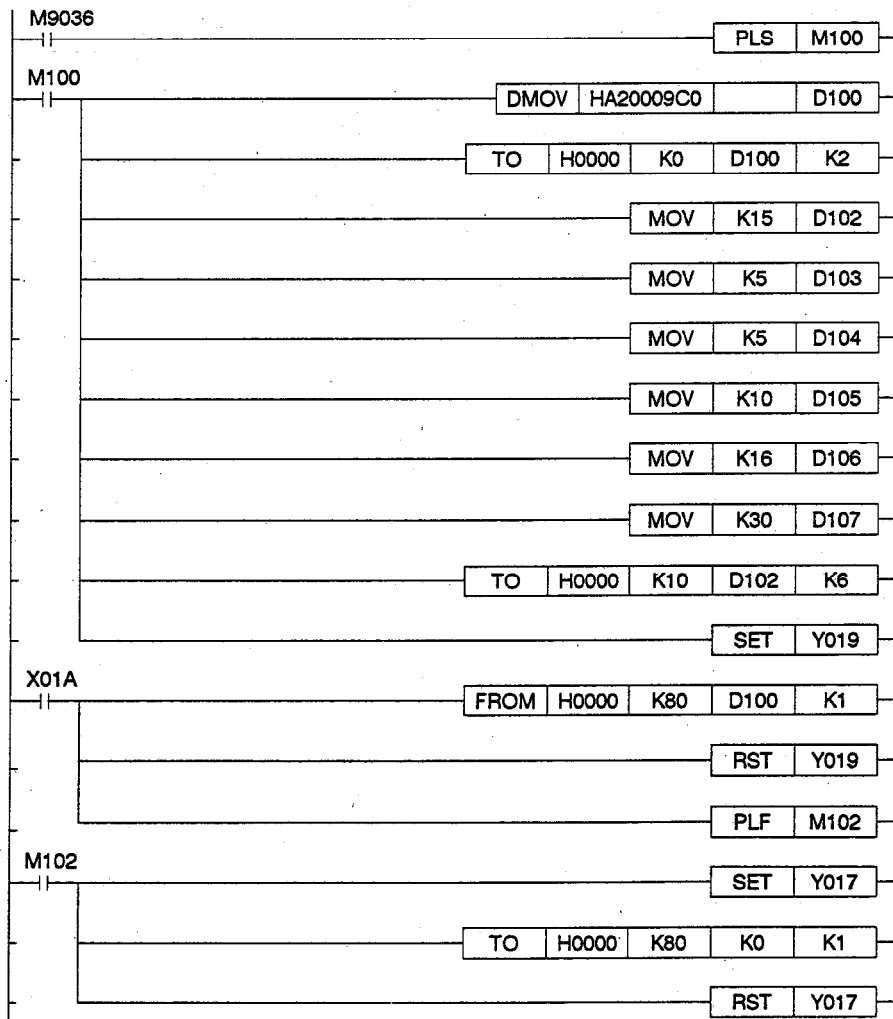

The IP address of the AJ71E71 is set at A20009C0H.
 The IP address is written to buffer memory.
 The TCP UDP time value is set at 15 (30 seconds).
 The TCP zero window timer is set at 5 (10 seconds).
 The TCP retransmission timer value is set at 5 (10 seconds).
 The TCP completion timer value is set at 10 (20 seconds).
 The IP assembly timer value is set at 16 (32 seconds).
 The response watch dog timer value is set at 30 (60 seconds).
 The initial processing data is written to buffer memory.
 The initial processing request signal is turned ON.
 An error code is read during an initial error.
 The "COM.ERR" LED goes OFF.
 The initial error code is cleared.

5.3 Open/Close of a Communications Line

Communications between an AJ71E71 and a maximum of eight nodes are enabled.

The AJ71E71 can allow fixed buffer communications, random access buffer communications, and data read/write communications in the PC CPU with a node to which a communications line has been opened.

Therefore, even if only data read/write in the random access buffer communications and the PC CPU is performed, open processing must be done.

5.3.1 Data for opening a communications line

This section shows the communications parameter setting area (buffer addresses 16 to 79) to use for open processing of a communications line.

Buffer Memory Address	Setting Description	
16	Connection No. 1	Application setting area
17	Connection No. 2	
18	Connection No. 3	
19	Connection No. 4	
20	Connection No. 5	
21	Connection No. 6	
22	Connection No. 7	
23	Connection No. 8	
24	AJ71E71 port number	Connection No.1 communications address setting area
25	Node IP address	
26	Node port number	
27	Node port number	
28	Node Ethernet address (L) to (H)	
29	Node Ethernet address (L) to (H)	Connection No.2 communications address setting area
30	Node Ethernet address (L) to (H)	
31	AJ71E71 port number	
32	Node IP address	
33	Node port number	
34	Node port number	Connection No.2 communications address setting area
35	Node Ethernet address (L) to (H)	
36	Node Ethernet address (L) to (H)	
37	Node Ethernet address (L) to (H)	
38	Node Ethernet address (L) to (H)	
39	AJ71E71 port number	Connection No.2 communications address setting area
40	Node IP address	
41	Node port number	
42	Node port number	
43	Node Ethernet address (L) to (H)	
44	Node Ethernet address (L) to (H)	Connection No.4 communications address setting area
45	AJ71E71 port number	
46	Node IP address	
47	Node port number	
48	Node port number	
49	Node Ethernet address (L) to (H)	
50	Node Ethernet address (L) to (H)	
51	Node Ethernet address (L) to (H)	

Buffer Memory Address	Setting Description	+
52	AJ71E71 port number	Connection No.5 communications address setting area
53	Node IP address	
54	Node port number	
55	Node port number	
56	Node Ethernet address (L) to (H)	
57	Node Ethernet address (L) to (H)	Connection No.6 communications address setting area
58	Node Ethernet address (L) to (H)	
59	AJ71E71 port number	
60	Node IP address	
61	Node port number	
62	Node port number	Connection No.7 communications address setting area
63	Node Ethernet address (L) to (H)	
64	Node Ethernet address (L) to (H)	
65	Node Ethernet address (L) to (H)	
66	Node Ethernet address (L) to (H)	
67	AJ71E71 port number	Connection No.8 communications address setting area
68	Node IP address	
69	Node port number	
70	Node port number	
71	Node Ethernet address (L) to (H)	
72	Node Ethernet address (L) to (H)	
73	AJ71E71 port number	Connection No.8 communications address setting area
74	Node IP address	
75	Node port number	
76	Node port number	
77	Node Ethernet address (L) to (H)	
78	Node Ethernet address (L) to (H)	
79	Node Ethernet address (L) to (H)	

* When the node to be connected has an ARP function (broadcast), set a default (value = FFFFFFFFHH).

- (1) This section shows the application setting area (buffer addresses 16 to 23) for a communications parameter.

Set a condition of the communications of each connection from No. 1 to No. 8 at one-word data as bit information. One-word data is described below.

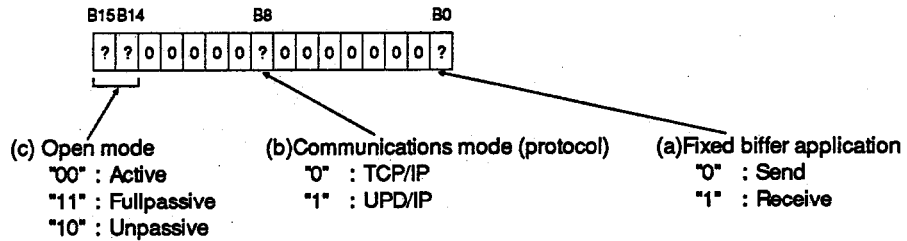

(a) Setting a fixed buffer application for each connection

Set either send or receive at a fixed buffer application for each connection.

Two fixed buffers (for send and receive) are required to transmit and receive to/from a specific node. Therefore, two connections must be set.

(b) Setting the protocol for each connection

Set the communications protocol for each connection at TCP/IP or UDP/IP.

(c) Open mode setting of each connection

This setting is valid only when the protocol is TCP/IP. (It is unnecessary with UDP/IP/.) Therefore, set it at "0".

When open processing with a UDP/IP, after completing open processing with a node to be opened by a fullpassive/unpassive open, do open processing with the node to be opened by an active open.

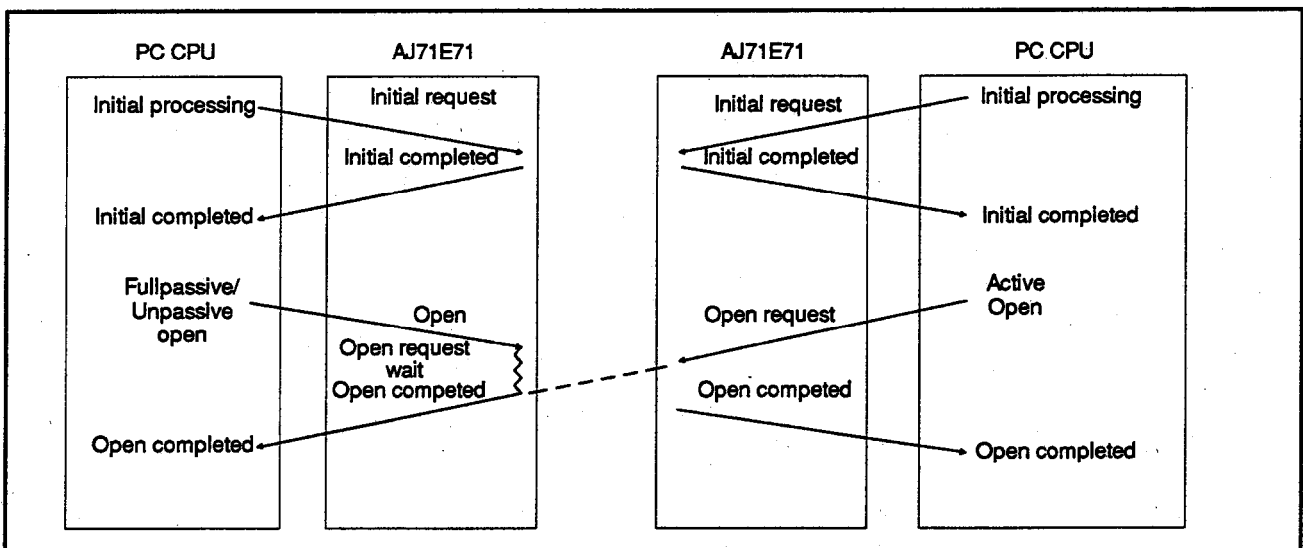

Fig. 5.3 TCP Open Processing Operations

1) Active open mode

Active open processing is done for the node in the open passive state.

2) Fullpassive open mode

Fullpassive open processing is done only for the specific node set at the communications address setting area.

Then, the AJ71E71 waits for an active open request from the node set at the communications address setting area.

3) Unpassive open mode

Unpassive open processing is done for all nodes connected to the network.

Then, the AJ71E71 waits for an active open request from all nodes in the network.

(d) Sample data setting of an application setting area

Table 5.1 Applications Setting Data

Protocol		Application	Send	Receive
TCP	Active		0000H	0001H
	Passive	Fullpassive	C000H	C001H
		Unpassive	8000H	8001H
UDP			0100H	0101H

(2) This section shows the communications address setting area (buffer addresses 24 to 79) for a communications parameter.

Set the address and the port number of the node to be linked by each connection.

Also, set the value determined by the network manager here.

(a) AJ71E71 port number setting (Setting range is from 0100H to FFFFH.)

Set the port number of the AJ71E71 to be connected to a node.

Connections	Connection Description	Communications Protocol	
		TCP	UDP
	In this protocol, when connected to more than one node, several AJ71E71 ports are set.	o	o
	In this protocol, when connected to more than one node, a single AJ71E71 port is set.	o	x
	In this protocol, when connected to more than one port in one node, several AJ71E71 ports are set.	o	o
	In this protocol, when connected to more than one port in one node, a single AJ71E71 port is set.	o	x
	Multiple connections cannot be done using a single node port and a single AJ71E71 port.	x	x

Fig. 5.4 Various Connections

(b) IP node address of a node

Set the IP address of a communicating node.

(c) Port number of a node

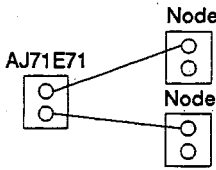
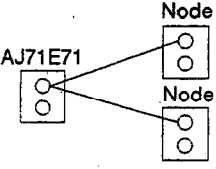
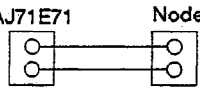
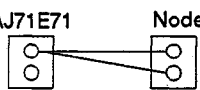
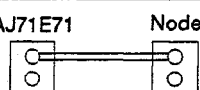
Set the port address of a communicating node.

(d) Ethernet address of a node (Default = FFFFFFFFHH)

If a communicating node does not have an ARP (broadcast) function, set the Ethernet address to that node.

5. COMMUNICATING WITH OTHER NODES

MELSEC-A

When a value is set, the node does not have any ARP function except a default value. Therefore, the AJ71E71 is accessed by the set Ethernet address.

Be sure to set a default (value =FFFFFFFFFH) when a node has the ARP function.

Example: If the Ethernet address is 080070220004H, the data settings are as follows:



(e) Table 5.2 shows the relationship between the open mode and communications parameters.

Table 5.2 Relationship Between Open Mode and Communications Parameter Data Settings

			AJ71E71 Port Number	Node IP Address	Node Port Number	Ethernet Address
TCP	Active	Node with an ARP function	Setting needed	Setting needed	Setting needed	Default value (0)
		Node without an ARP function				Setting needed
	Passive	Unpassive	Setting needed	Setting not needed	Setting not needed	Setting not needed
		Fullpassive	Setting needed	Setting needed	Setting needed	Setting not needed
UDP		Node with an ARP function	Setting needed	Setting needed	Setting needed	Default value (0)
		Node with an ARP function				Setting needed

5.3.2 Open processing of communications line

This section shows the open processing of an AJ71E71.

Initial processing must be completed before open processing can be done.

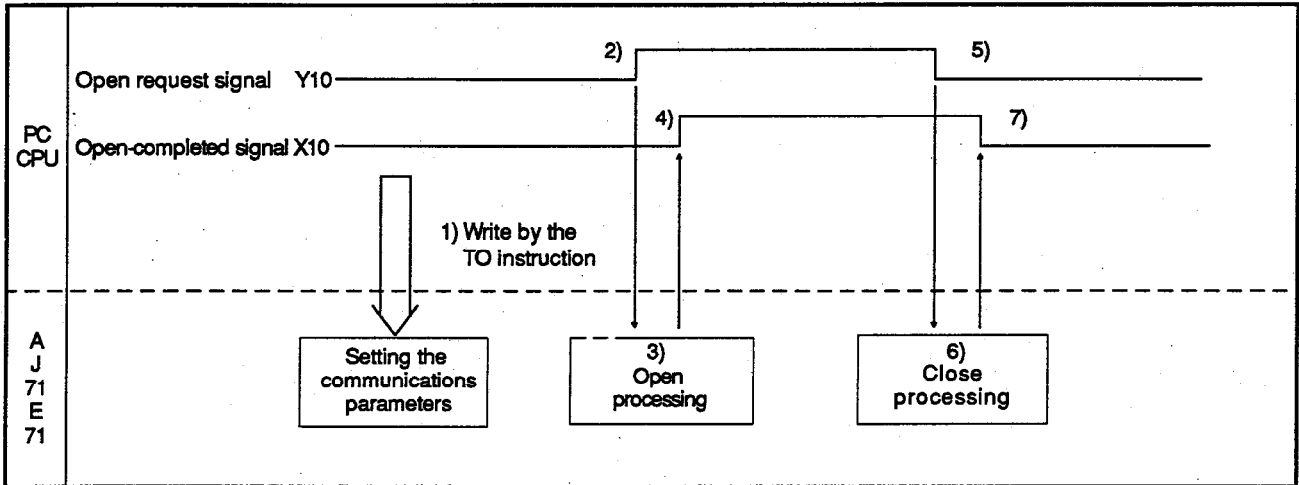

Fig. 5.5 Open Processing

- (1) Communications parameters are written to the parameter setting area by the TO instruction of a sequence program.
- (2) The open request signal (Y10 to Y 17) is turned ON by the sequence program.
- (3) The AJ71E71 executes open processing.
- (4) When open processing is completed, the AJ71E71 turns ON the open-completed signal (X10 to X17).
- (5) The open request signal (Y10 to Y17) is turned OFF by the sequence program.
- (6) The AJ71E71 executes close processing.
- (7) When close processing is completed, the AJ71E71 turns OFF the open-completed signal (X10 to X17).

POINTS

(1) In the case of software package "H" and later versions, if it has not been possible to close the connection within the time set by the TCP completed timer value, RST processing is performed at the communicating node to forcibly execute close processing.

(2) In the case of software package "G" and earlier versions, close processing is performed by handshaking with the communicating node.

Close processing at the communicating node may not be possible even when the open request signal (Y8 to YF) is switched OFF (the open completed signal X10 to X17 fails to go OFF). In this case, use one of the two methods below to effect closure.

(a) Switch the initial request signal (Y19) OFF

Send an RST signal to all connections for which open processing has been completed in order to close them.

(b) Send dummy data by fixed buffer communication

Since there is a fault at the communicating node, a TCP time out error occurs and the connection is closed. (This method for closure can only be used if the connection was opened with the SW1 switch OFF, with "send use" set for the fixed buffer, and with TCP/IP as the communication protocol).

Except for close processing using a sequence program (open request signal OFF), the connection is automatically closed (open completed signal is turned OFF) in the following cases:

To reopen the connection, start open processing after turning the open request signal (Y8 to YF) OFF.

Table 5.3 Closed Communications Lines

Closed Processing	Cause of Closed Processing	Open Processing		
		Error Signal (X 18)	Completed Signal (X10 to X17)	Error Code (Address of buffer memory; 93, 103, 113, 123, 133, 143, 153, 163)
TCP ULP timeout error	When the TCP protocol is used, even if retry processing is done, ACK is not transmitted back (see Section 9.1.2).	ON	Changed by the ON/OFF DIP switch (see Section 4.3.3)	9059H
Response monitoring timeout error	The data set value in application data set by the user is larger than an actual data quantity (see Section 9.2).	ON	OFF	71H
Close request from a node	"CLOSE" or "ABORT" instruction sent from a node.	OFF	OFF	-

(8) The method for reopening a connection after closing it is explained here.

(a) To reopen a connection after close processing (switching the open request signal OFF) has been executed by the sequence program, switch the open request signal ON a minimum of 500 ms after the open completed signal has gone OFF (after close processing has been completed).

The open request signal and open completed signal come ON and go OFF in accordance with the timing as shown in figure 5.6.

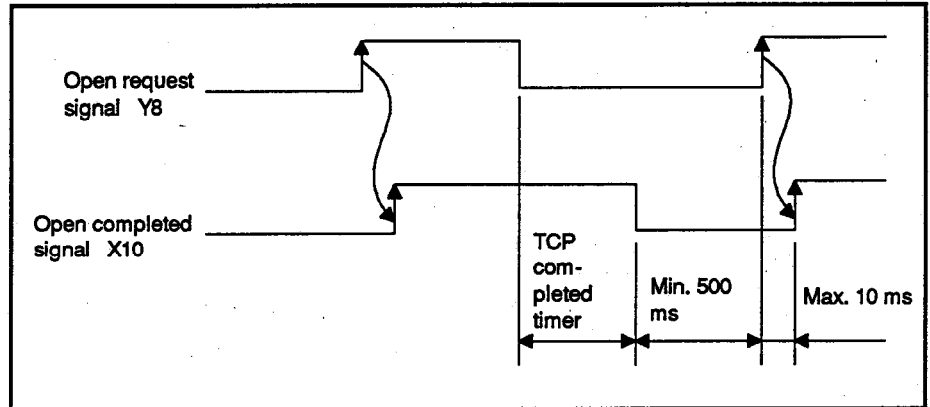

Fig. 5.6 Reopen Processing When Connection Closed by Sequence Program

(b) To reopen a connection that has been closed from the communicating node (see Table 5.3), first switch OFF the open request signal. Then, at least 500 ms after the open request signal has gone OFF, switch the open request signal ON.

The open request signal and open completed signal come ON and go OFF in accordance with the timing as shown in figure 5.7.

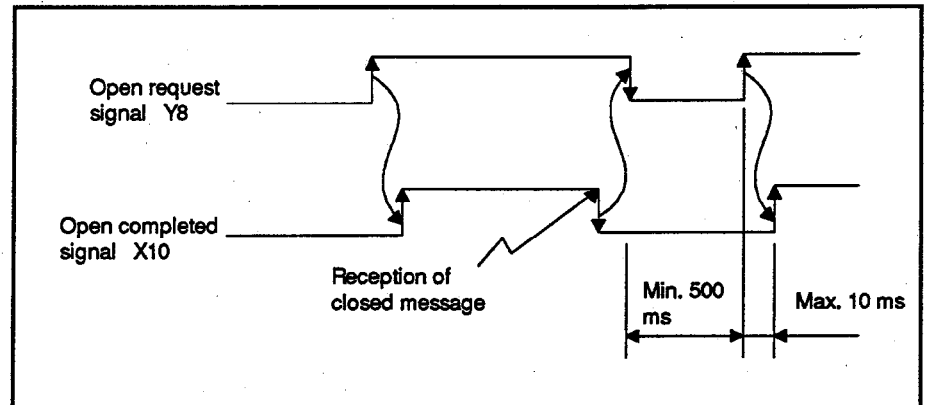

Fig. 5.7 Reopen Processing When Connection Closed From Communicating Node

5. COMMUNICATING WITH OTHER NODES

MELSEC-A

5.3.3 Communications line status storage area

This section shows the AJ71E71 communications state storage area (buffer addresses 80 to 178).

This area is used for storing the communications status of an AJ71E71 port, the IP address of a communicating node, various error codes, the fixed buffer communications time, etc., of each communications state.

The communications status of different connections can be confirmed by reading this area.

Buffer Memory Address	Setting Description		
89	AJ71E71 port number		Connection No.1
90	Node IP address		
91	Node port number		
92	Open error code		
93	Fixed buffer send error code		
94	Fixed buffer send completed code		
95	Fixed buffer communications time storage	Maximum	
96		Minimum	
97		Present	
98	AJ71E71 port number		Connection No.2
99	Node IP address		
100	Node port number		
101	Open error code		
102	Fixed buffer send error code		
103	Fixed buffer send completed code		
104	Fixed buffer communications time storage	Maximum	
105		Minimum	
106		Present	
107	AJ71E71 port number		Connection No.3
108	Node IP address		
109	Node port number		
110	Open error code		
111	Fixed buffer send error code		
112	Fixed buffer send completed code		
113	Fixed buffer communications time storage	Maximum	
114		Minimum	
115		Present	
116	AJ71E71 port number		Connection No.4
117	Node IP address		
118	Node port number		
119	Open error code		
120	Fixed buffer send error code		
121	Fixed buffer send completed code		
122	Fixed buffer communications time storage	Maximum	
123		Minimum	
124		Present	

Buffer Memory Address	Setting Description		
129	AJ71E71 port number		Connection No.5
130	Node IP address		
131	Node port number		
132	Open error code		
133	Fixed buffer send error code		
134	Fixed buffer send completed code		
135	Fixed buffer communications time storage	Maximum	
136		Minimum	
137		Present	
138	AJ71E71 port number		Connection No.6
139	Node IP address		
140	Node port number		
141	Open error code		
142	Fixed buffer send error code		
143	Fixed buffer send completed code		
144	Fixed buffer communications time storage	Maximum	
145		Minimum	
146		Present	
147	AJ71E71 port number		Connection No.7
148	Node IP address		
149	Node port number		
150	Open error code		
151	Fixed buffer send error code		
152	Fixed buffer send completed code		
153	Fixed buffer communications time storage	Maximum	
154		Minimum	
155		Present	
156	AJ71E71 port number		Connection No.8
157	Node IP address		
158	Node port number		
159	Open error code		
160	Fixed buffer send error code		
161	Fixed buffer send completed code		
162	Fixed buffer communications time storage	Maximum	
163		Minimum	
164		Present	
165	AJ71E71 port number		Error log area This area is for all areas not resulting from a fixed buffer send (ring buffer).
166	Node IP address		
167	Node port number		
168	Open error code		
169	Fixed buffer send error code		
170	Fixed buffer send completed code		
171	Fixed buffer communications time storage	Maximum	
172		Minimum	
173		Present	
174	AJ71E71 port number		
175	Node IP address		
176	Node port number		
177	Open error code		
178	Fixed buffer send error code		
179	Fixed buffer send completed code		

- (1) AJ71E71 port number (buffer addresses 89, 99, 109 through 159)

These store the port number of a set AJ71E71 during the open processing of each connection.

- (2) Node IP address (buffer addresses 90, 100, 110 through 160)

These store the set node IP address during the open processing of each connection.

If the IP address is "A20009C0H", the storage data is shown below.

Address	Buffer memory storage data
90	09C0H
91	A200H

- (3) Node port number (buffer addresses 92, 102, 112 through 162)

These store the set node port number during the open processing of each connection.

- (4) Open error codes (buffer memory 93, 103, 113 through 163)

(a) These store the error codes that occur in the open processing of each connection (binary value).

(b) Section 9.1.2 gives details about open error codes.

(c) The error code is cleared in the following cases:

- 1) The connection where the open error occurred could be opened again, and it could be opened normally.
- 2) The PC CPU is reset, or PC power is turned OFF.

- (5) Error codes during fixed buffer send (buffer addresses 94, 104, 114 through 164)

(a) These store the error codes that occur during the fixed buffer send of each connection (binary value).

(b) Section 9.1.3 gives details about fixed buffer send error codes.

(c) The error code is cleared in the following cases:

- 1) Turn OFF the fixed buffer request-to-send signal of the connection where the send error occurred.
- 2) The PC CPU is reset, or PC power is turned OFF.

- (6) Response-completed codes during fixed buffer send (buffer addresses 95, 105, 115 through 165)
 - (a) These store the response-completed code to be sent back during the fixed buffer send of each connection (binary value)
 - (b) Section 9.1.3 gives details about response-completed codes.
 - (c) Response-completed codes are cleared when (a) the PC CPU is reset, or (b) when PC power is turned OFF.

- (7) Storage of the communicating times of fixed buffer communications (buffer addresses 96, 106, 116 through 166)
 - (a) The maximum value, the minimum value and the present value of the processing time of fixed buffer communications are stored.
 - (b) The processing time is stored in 10 msec units (binary value).
 - (c) During processing time, the following values are stored:
 - 1) Send processing time with a fixed buffer
The time after a request-to-send signal goes ON until the AJ71E71 completes a send.
 - 2) Receive processing time with a fixed buffer
The time after a receive-completed signal goes ON until the AJ71E71 completes the reply processing.

- (8) Error log area (buffer addresses 169 to 179)
 - (a) This is the area where AJ71E71 stores the errors (buffer addresses 94, 103, 112 and164) that did not result from a fixed buffer send.

Any error that occurred while transmitting a fixed buffer is stored in the fixed buffer send error code area (buffer addresses 94, 103, and 112 through 164).
 - (b) This error area can store 11 words. This area also includes a ring buffer that can store information on up to 10 error cases.

This data area is initially set to 0000H.

Therefore, it is possible to see if a relevant data is old or not.
 - (c) Usually, This area does not need to be read. However, it is necessary to read it during maintenance.

5.3.4 Open processing program example

This section shows the sequence program to open connections between an AJ71E71 and a node.

Example: When an AJ71E71 performs data communications with a node, the communications parameters are as follows:

Parameter Name		Connection No. 1	Connection No. 2
Fixed buffer	Application	Send	Receive
	Protocol	TCP	TCP
	Open mode	Unpassive	Unpassive
AJ71E71 port number		500H	501H
Node	IP address	*A20009C1H	*A20009C1H
	Port number	*500H	*501H
Node Ethernet address		Default with ARP	Default with ARP

*Since this setting example is unpassive, the IP address and port number of the other node do not need to be set.

Open processing of connection No. 1

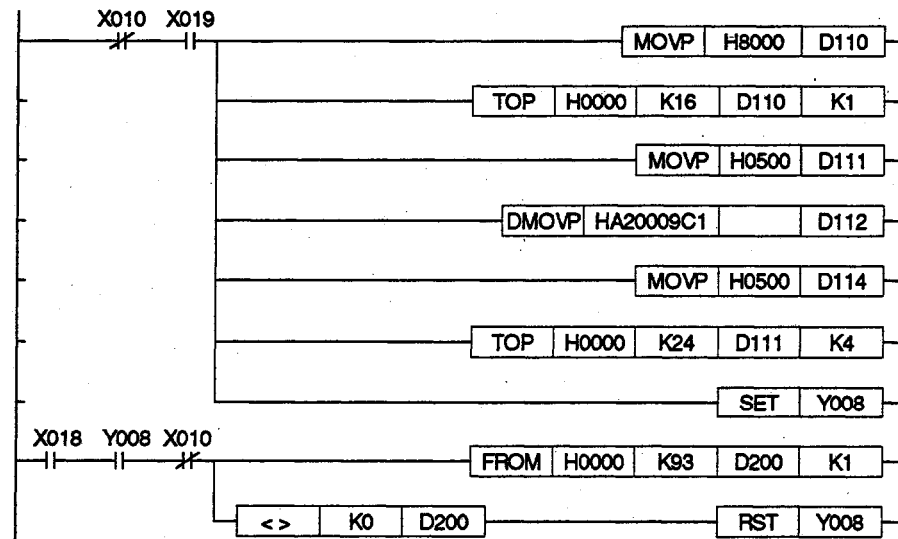

The set data of a send, TCP and Unpassive are written in the applications area of connection No. 1.

The port number of the AJ71E71 is set at 500H.

The IP address of the node is set at A20009C1H.

The port number of the node is set at 500H.

Writing to the communications address setting area of connection No. 1

The open request number of connection No. 1 is turned ON.

Open error processing of connection No. 1

Open processing of connection No. 2

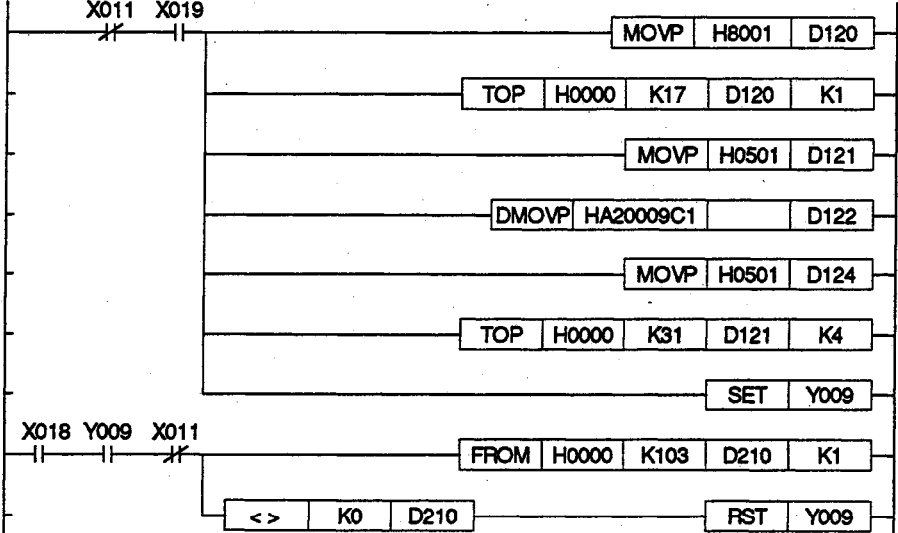

The set data of a send, TCP and Unpassive are written in the applications area of connection No. 2.

The port number of the AJ71E71 is set at 501H.

The IP address of the node is set at A20009C1H.

The port number of the node is set at 501H.

Writing to the communications address setting area of connection No. 2

The open request number of connection No. 2 is turned ON.

Open error processing of connection No. 2

6. COMMUNICATIONS PROCESSING USING FIXED BUFFER MEMORY MELSEC-A

6. COMMUNICATIONS PROCESSING USING FIXED BUFFER MEMORY

6.1 Control Methods

During communications processing with another node using fixed buffer memory, read/write of data from/to a PC CPU are executed by using handshake signals.

- (1) The data flow in data communications processing to and from fixed buffer memory areas is shown below.

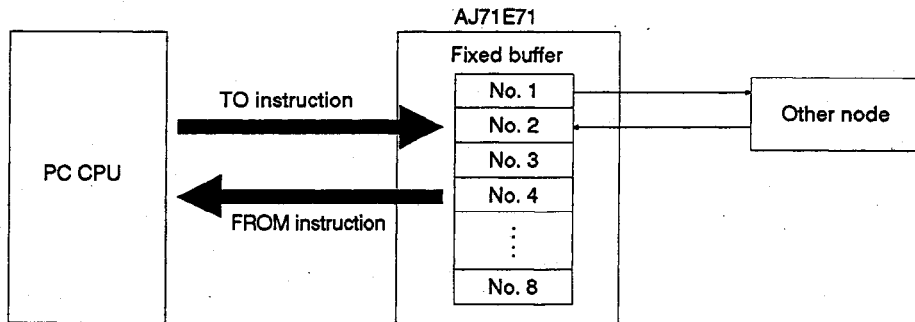

- (2) During data communications to and from fixed buffer memory areas, the particular communicating node and the use (send or receive) are set for each of the fixed buffer memory areas (Nos. 1 to 8) when the communications line of an AJ71E71 is opened (see Section 5.3). This fixes the buffer memory areas allocated for communicating with other nodes.

Example:

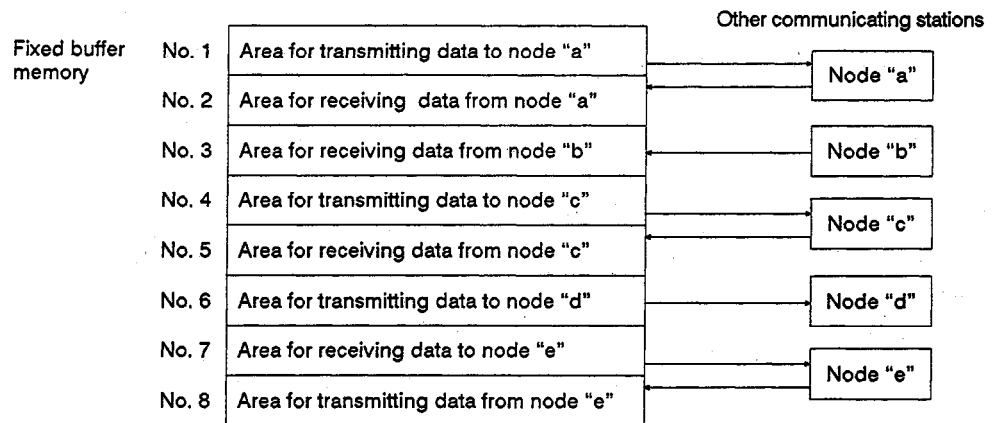

- (3) The parameter setting of the fixed buffer memory areas for each communicating station becomes valid at the leading edge of the AJ71E71 communications line open-completed signal.

The communicating station cannot be changed while the communications line open-completed signal is ON.

6. COMMUNICATIONS PROCESSING USING FIXED BUFFER MEMORY MELSEC-A

6.1.1 Send Control methods

Data send control methods when transmitting data from an AJ71E71 to another node are explained below (taking data transmitted from fixed buffer memory area No. 1 to another node as an example).

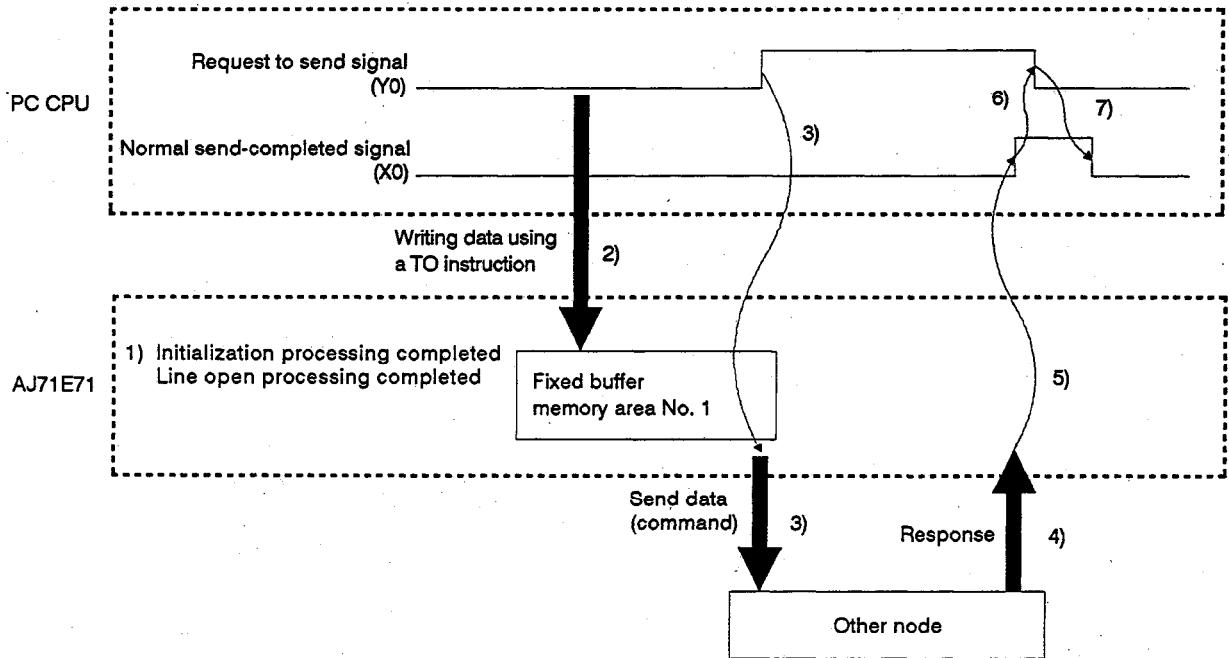

(1) The AJ71E71 is initialized (see Section 5.2).

The communications line open processing is executed (see Section 5.3).

6. COMMUNICATIONS PROCESSING USING FIXED BUFFER MEMORY MELSEC-A

- (2) The sequence program TO instruction writes the send data length and the send data to the fixed buffer memory areas of the AJ71E71.

The send data length is written to the head addresses (512, 1536, 2560, 3584) of fixed buffer memory areas Nos. 1 to 8.

The data to be transmitted is written to the area that follows the head address.

The following example shows the procedure for transmitting 100 words of data using fixed buffer memory area No. 1.

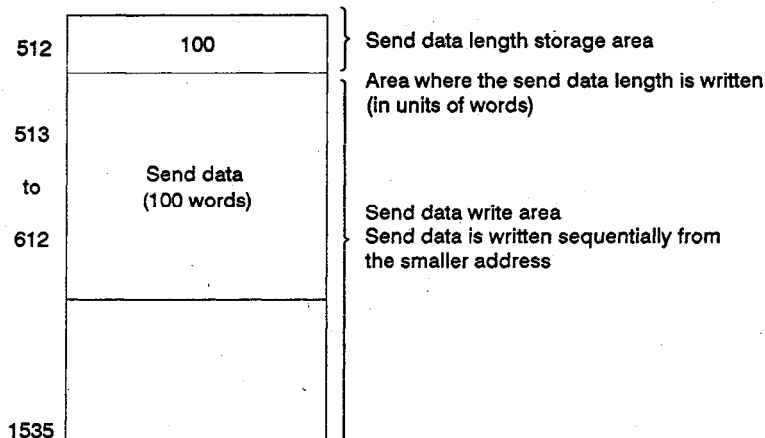

- (3) By turning ON the request to send signal (Y0 for fixed buffer memory area No. 1) with a sequence program, data in the designated fixed buffer memory address areas is transmitted to the parameter-set designated node.
- (4) The designated node, in response to data received from an AJ71E71, returns a "response" to the AJ71E71.
- (5) The AJ71E71 turns the normal send-completed signal (X0 for fixed buffer memory area No. 1) ON when it receives the "response" from the designated node.
- (6) The sequence program turns OFF the request to send signal (Y0 for fixed buffer memory area No. 1) when the normal send-completed signal goes ON.
- (7) The normal send-completed signal goes OFF when the request to send signal is turned OFF.

If data send is not correctly completed (no response from another node or if the responding end code is not "00H"), the send error detection signal (X1) goes ON. In this case, the normal send-completed signal (X0) does not go ON.

If the X1 signal is ON, turn the request to send signal ON and retry data send processing.

6. COMMUNICATIONS PROCESSING USING FIXED BUFFER MEMORY MELSEC-A

6.1.2 Receive control methods

The data receive control method when an AJ71E71 receives data from another node is explained below (taking data received by fixed buffer memory area No. 2 from another node as an example).

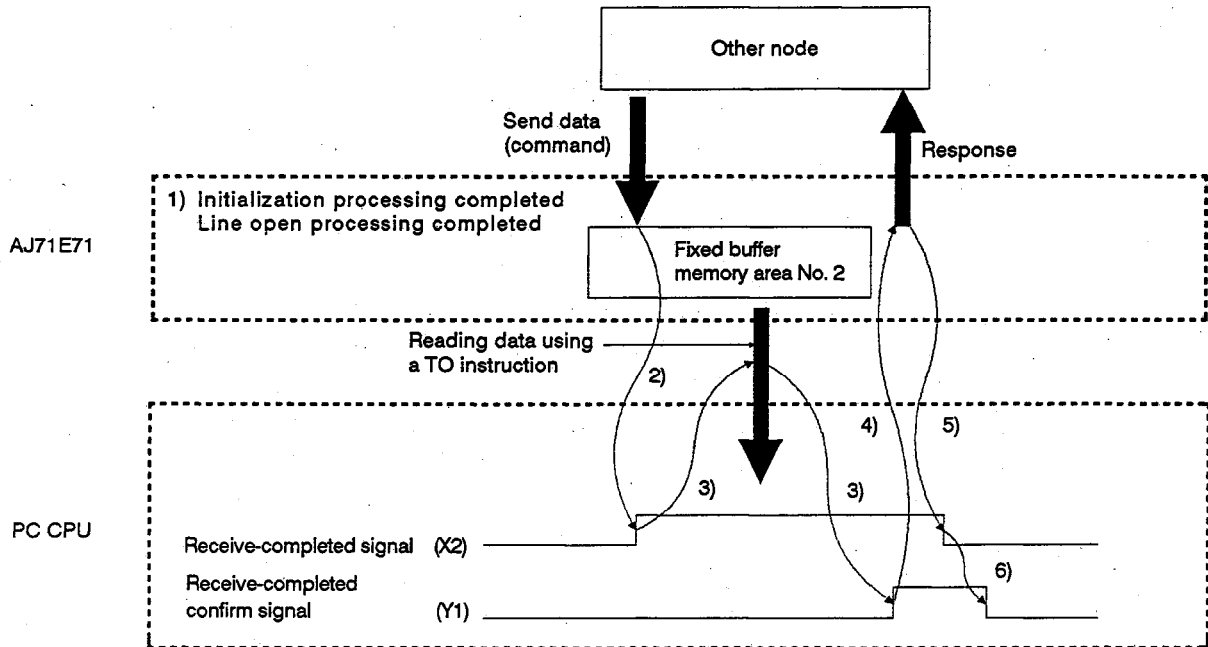

(1) The AJ71E71 is initialized (see Section 5.2).

The communications line open processing is executed (see Section 5.3).

6. COMMUNICATIONS PROCESSING USING FIXED BUFFER MEMORY MELSEC-A

- (2) The AJ71E71 turns ON the receive-completed signal (X2 for fixed buffer memory area No. 2) when data from another node is received in the set fixed buffer memory areas.

The received data length and received data are stored in the fixed buffer memory areas.

The received data length is written to the head addresses (512, 1536, 2560, 3584) of fixed buffer memory areas Nos. 1 to 8.

The received data is written to the area that follows the head address.

The following chart shows what happens when 200 words of data are received in fixed buffer memory area No. 2.

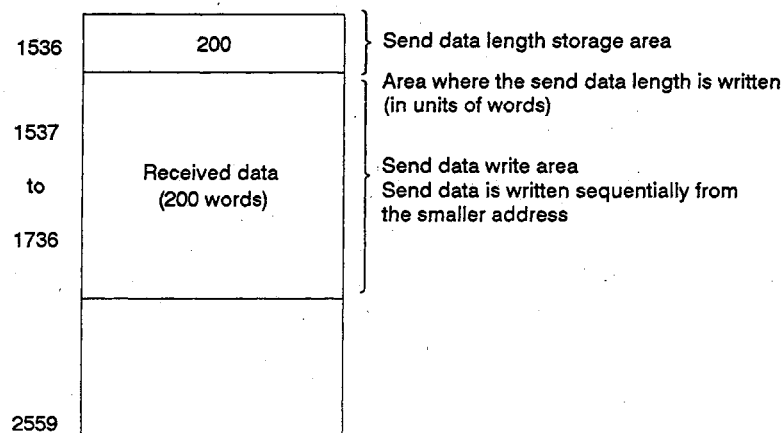

- (3) When the receive-completed signal is turned ON, the FROM instruction in a sequence program reads the received data length and received data stored in the fixed buffer memory areas.

At the same time, turn ON the receive-completed confirmation signal (Y1 for fixed buffer memory area No. 2) with a sequence program.

- (4) The AJ71E71, in response to the turning ON of the receive-completed confirmation signal, returns a "response" to the parameter-set other node.
- (5) After returning the "response", the AJ71E71 automatically turns OFF the receive-completed signal.
- (6) The sequence program turns OFF the receive-completed confirmation signal when the receive-completed signal goes OFF.

If data receive is abnormal, (a) the receive-completed signal (X2) is not turned ON and, (b) the received data is not stored in fixed buffer memory area No. 2.

6. COMMUNICATIONS PROCESSING USING FIXED BUFFER MEMORY MELSEC-A

6.2 Data Format

Communications data consists of "header" and "application data" as explained below.



Max. 2040 bytes

The header for TCP/IP or UDP/IP of Ethernet/Cherpernet. Since the AJ71E71 automatically sets the header in front of the application data, the user does not have to set the header.

6.2.1 Application data format

The application data format varies depending on which code (binary or ASCII) will be used.

Whether the binary or ASCII code is used is set with the dip switches on the front panel of the AJ71E71. Section 4.3.3 gives setting details.

Communications in binary code:

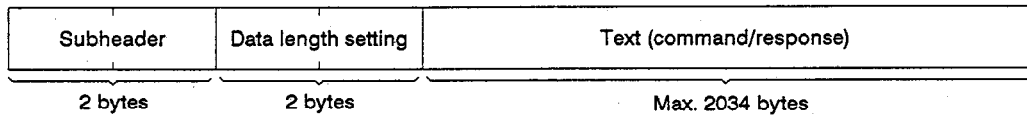

Communications in ASCII code:

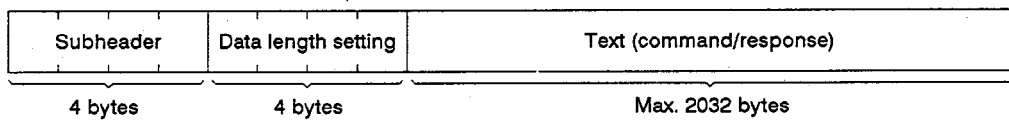

6. COMMUNICATIONS PROCESSING USING FIXED BUFFER MEMORY MELSEC-A

6.2.2 Subheader

Since the subheader is automatically set by the AJ71E71, the user does not have to set the subheader.

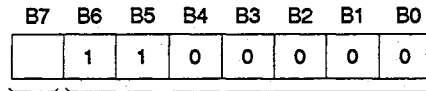

Command/response type
 (For communication using fixed buffer memory, the bit setting should be as indicated below.)

Command/response flag
 0 ... Command
 1 ... Response

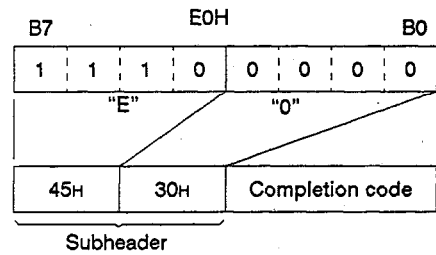
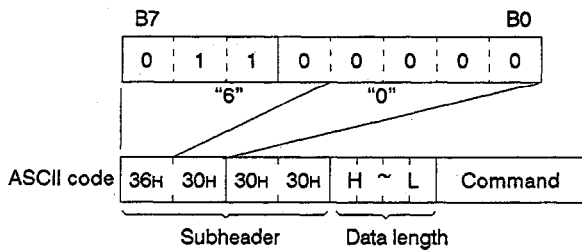
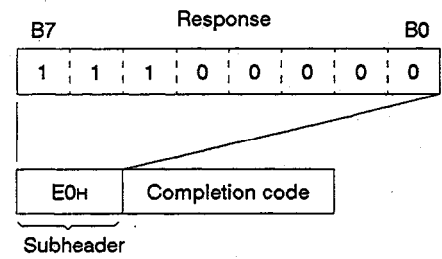
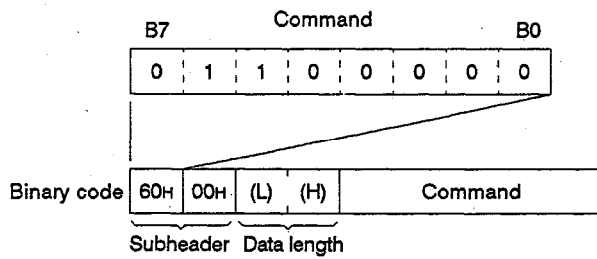

6. COMMUNICATIONS PROCESSING USING FIXED BUFFER MEMORY MELSEC-A

6.2.3 Command/response format

Binary Code Designation:

(1) Command format

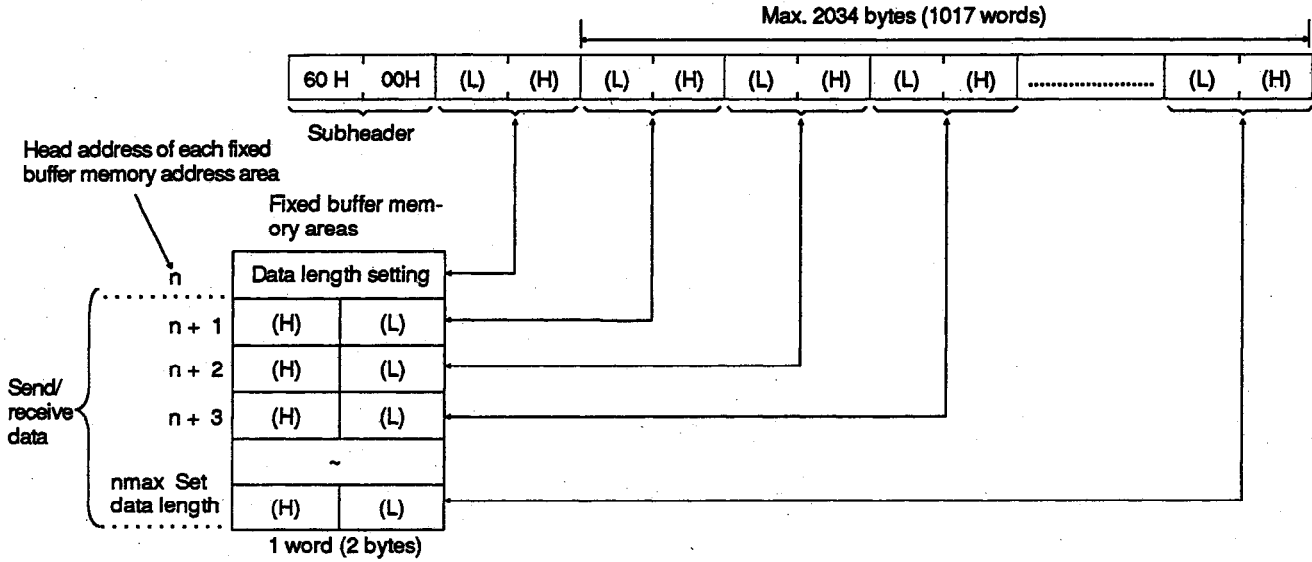

POINTS

- (1) When binary code is used, the maximum communications data length is 1017 words.
- (2) The data length setting range is 1 to 1017 (in units of words).

(2) Response format

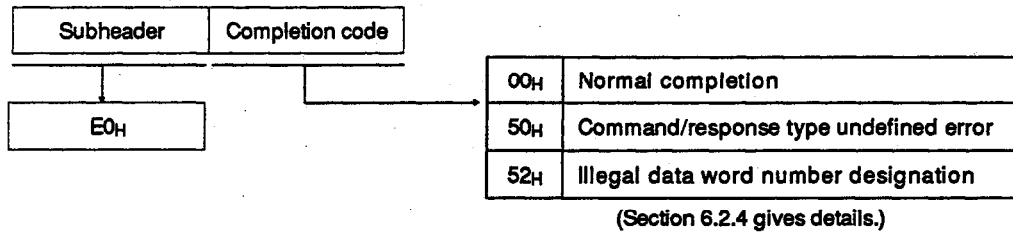

REMARK

Since the subheader is automatically set by the AJ71E71, the user does not have to set the subheader.

6. COMMUNICATIONS PROCESSING USING FIXED BUFFER MEMORY MELSEC-A

ASCII Code Designation

(1) Command format

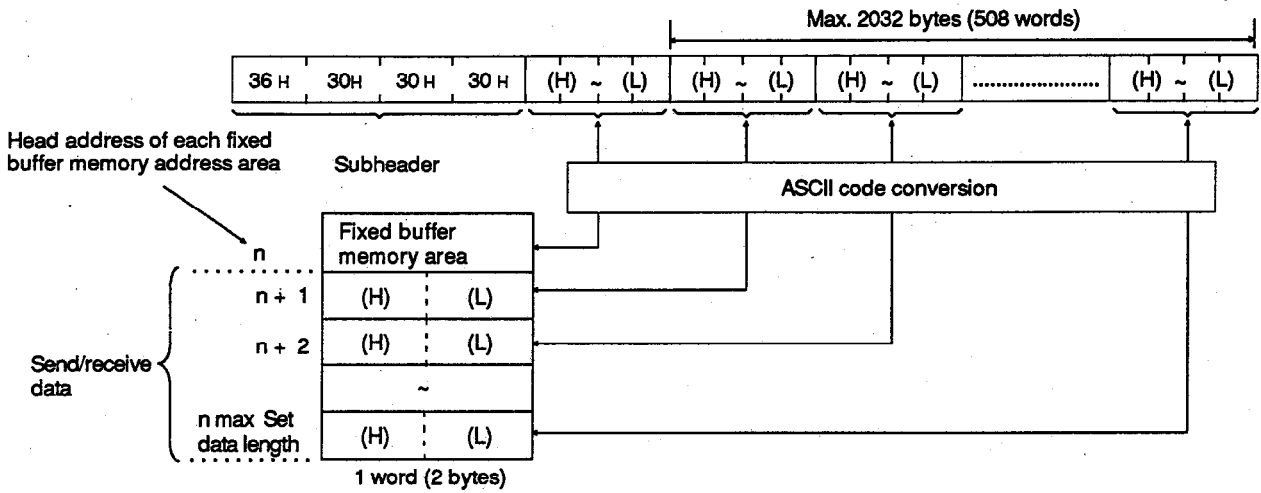

Example:

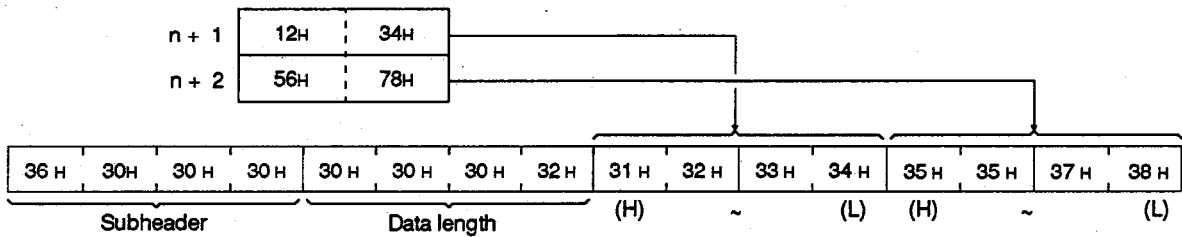

POINTS

- (1) When ASCII code is used, the maximum communications data length is 508 words. This is approximately half the maximum data length when binary code is designated.
- (2) The data length setting range is 1 to 508 (in units of words).

(2) Response format

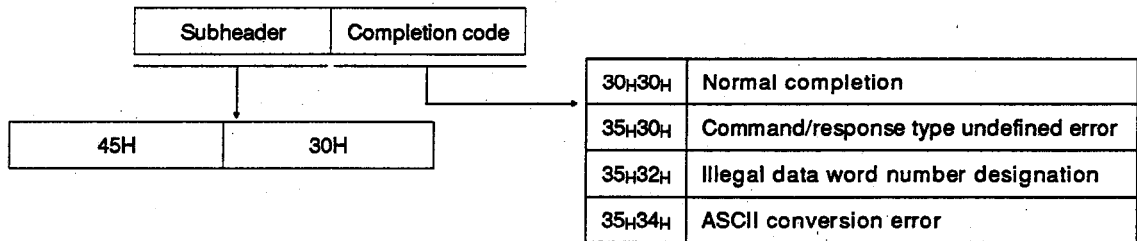

(Section 6.2.4 gives details.)

REMARK

Since the subheader is automatically set by the AJ71E71, the user does not have to set the subheader.

6. COMMUNICATIONS PROCESSING USING FIXED BUFFER MEMORY MELSEC-A

6.2.4 Completion code list

A completion code is stored in the communications status storage areas in buffer memory (Section 5.3.3 gives details).

Table 6.1 Completion Code List

Completion Code	Description	Corrective Action								
00H	Normal completion	-								
50H	The command/response type in the sub-header is not allowable code.	<ul style="list-style-type: none"> • Check the command/response type set by the communicating node and make corrections as necessary. (Since the command/response type is automatically set by the AJ71E71, the user does not have to set the command/response type.) • Check and correct the data length. 								
	<table border="1"> <thead> <tr> <th>Communications Processing</th> <th>Command/Response Type</th> </tr> </thead> <tbody> <tr> <td>Communications using fixed buffer memory</td> <td>60H</td> </tr> <tr> <td>Communications using random access buffer memory</td> <td>61H, 62H</td> </tr> <tr> <td>Read/write of data in PC CPU</td> <td>00H to 3CH</td> </tr> </tbody> </table>		Communications Processing	Command/Response Type	Communications using fixed buffer memory	60H	Communications using random access buffer memory	61H, 62H	Read/write of data in PC CPU	00H to 3CH
	Communications Processing		Command/Response Type							
	Communications using fixed buffer memory		60H							
Communications using random access buffer memory	61H, 62H									
Read/write of data in PC CPU	00H to 3CH									
	If the set data length is smaller than the actual length of data to be transmitted/received, any data exceeding the set length is regarded as the second data. This might cause a command/response type of undefined error (see Section 9.2).									
52H	Data of the designated number of words cannot be transmitted in one frame. The following lengths are excessive: 1017 words for binary code 508 words for ASCII code	Check and correct the number of data words of the communicating station.								
54H	If the AJ71E71 code setting is ASCII, an ASCII code that cannot be converted into the binary code is transmitted from the communicating station.	Check and correct the send data of the communicating station.								

6. COMMUNICATIONS PROCESSING USING FIXED BUFFER MEMORY

MELSEC-A

6.3 Programming

6.3.1 Precautions when programming

- (1) Communications using fixed buffer memory areas are possible only when the communications line open-completed signal (X10 to X17) is ON.

Initialization processing and communications line open processing must be completed (see Section 5).

- (2) The contents of parameter settings are received by the AJ71E71 at the leading edge of the communications line open request signal (Y8 to YF).

Therefore, control contents cannot be changed even if parameter settings are rewritten while the communications line open-completed signal (X10 to X17) is ON.

- (3) When transmitting data using the fixed buffer memory areas, set the length of data to be transmitted in the designated fixed buffer memory areas.

Using a set length greater than the allowable range causes a communications error and communications cannot be done.

- (4) When receiving data using the fixed buffer memory areas, turn ON the receive-completed confirmation signal (Y0 to Y7) when data receive is completed (receive-completed signal ON).

A "response" is returned to the other node when the receive-completed confirmation signal is turned ON.

If the receive-completed confirmation signal is not turned ON, a communications error occurs at the communicating node because a "response" has not been returned to that node.

6. COMMUNICATIONS PROCESSING USING FIXED BUFFER MEMORY MELSEC-A

6.3.2 Programming procedure

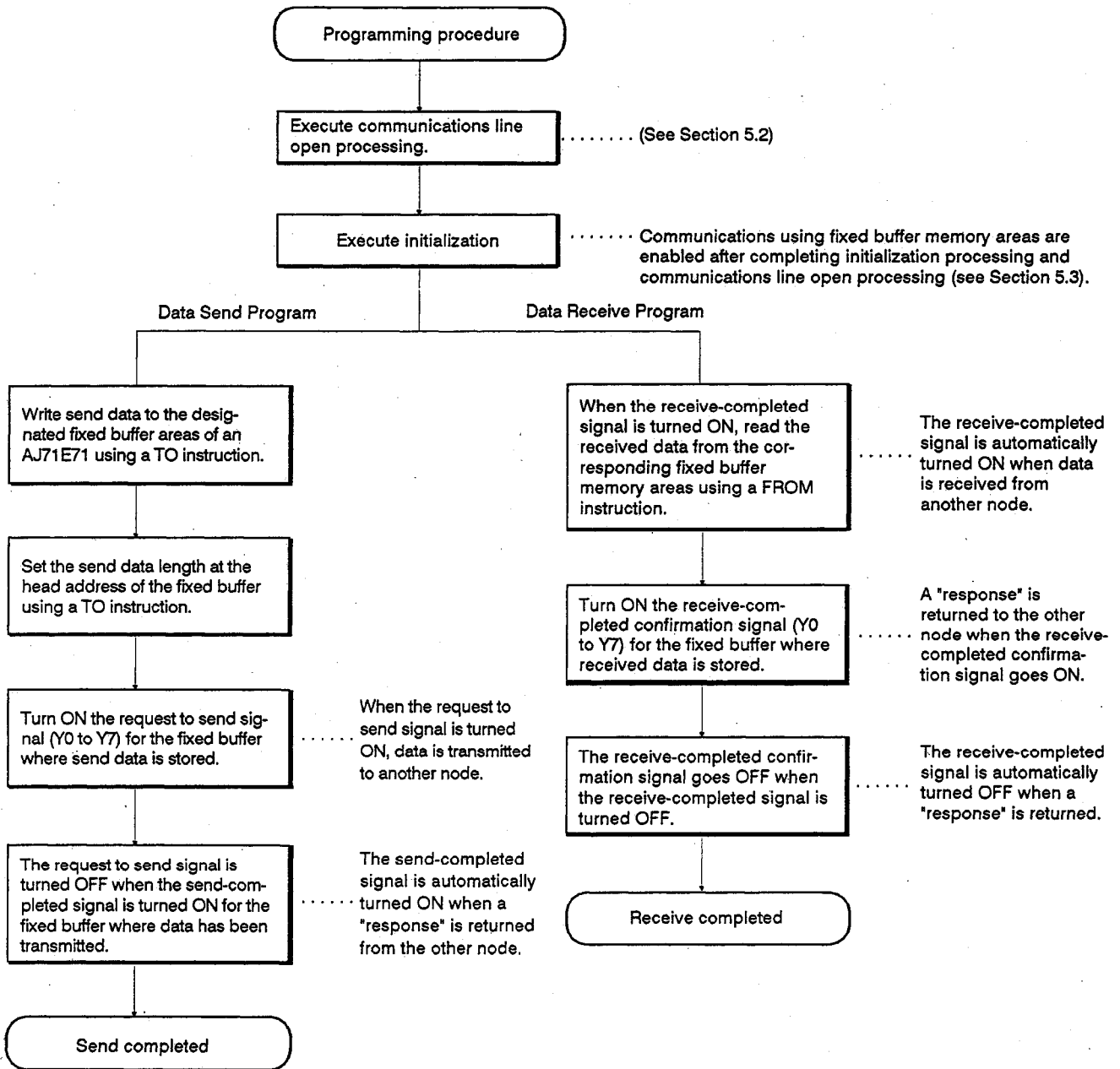

6. COMMUNICATIONS PROCESSING USING FIXED BUFFER MEMORY MELSEC-A

6.3.3 Sample communications program

This example assumes the following conditions:

- (a) The communications parameters for each connection are set as in Section 5.3.4.
- (b) Send data is set in D300 to D399.
- (c) Received data is stored in D500 to D599.
- (d) Error code and completion code are stored at:
 - D10: Send error code
 - D11: Communications end code

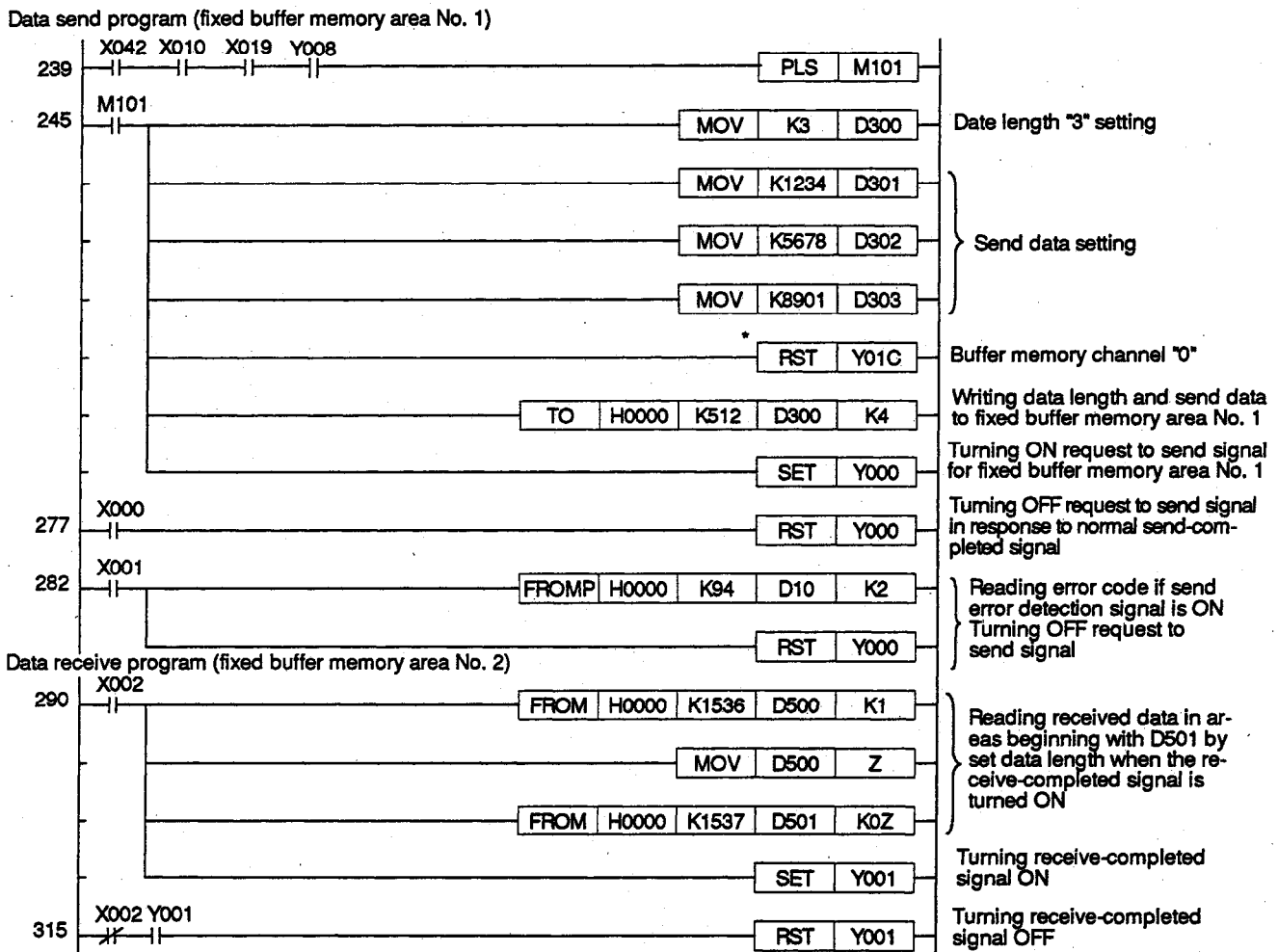

POINT

If the I/O control method used for the ACPU is the refresh method, Y1C (marked by the asterisk) will be output directly to the AJ71E71 and it is therefore necessary to add a partial refresh (SEG) command.

Adding this command ensures that Y1C is output to the AJ71E71 before the TO command in the next step is executed.

7. COMMUNICATION PROCESSING USING RANDOM ACCESS BUFFER MEMORY AREA

MELSEC-A

7. COMMUNICATION PROCESSING USING RANDOM ACCESS BUFFER MEMORY AREA

7.1 Control Method

In communication processing using random access memory area, writing data to random access buffer memory area and reading data from random access buffer memory area are initiated by a command (request) from other node.

This data read/write using the random access buffer memory area is executed independently of the execution of PC CPU's sequence program.

- (1) The random access buffer memory area is accessible from any node (except for AJ71E71) without designating the mating communication node.

Therefore, this area can be used as the buffer memory area common to all nodes connected to the Ethernet/Cheapernet.

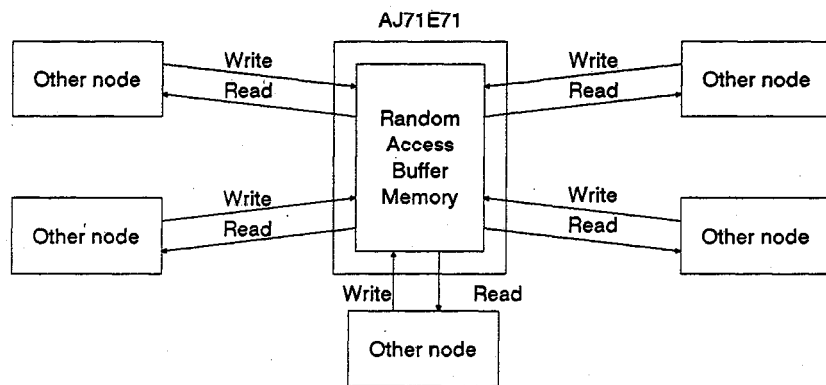

- (2) Data flow in data communication processing using the random buffer memory area is shown below.

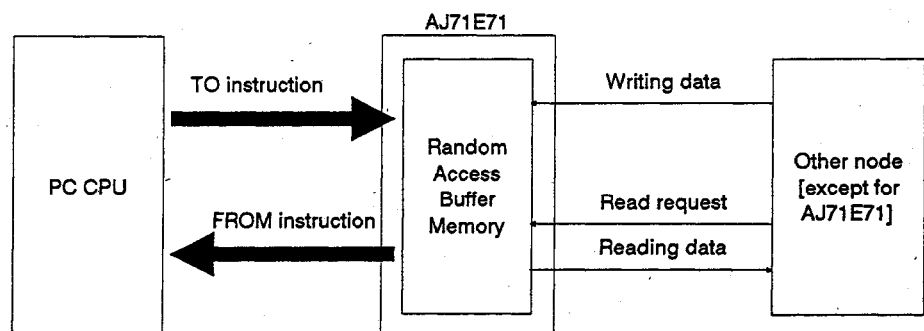

- (3) Communications between two AJ71E71 modules is not possible using random access buffer memory area.

7. COMMUNICATION PROCESSING USING RANDOM ACCESS BUFFER MEMORY AREA

MELSEC-A

- (4) Execution timing of FROM/TO instruction used for read/write operation between an AJ71E71 and a PC CPU is explained below.

Execution of FROM/TO instruction is suspended during communications with another node and is executed after the completion of communications.

Execution timing:

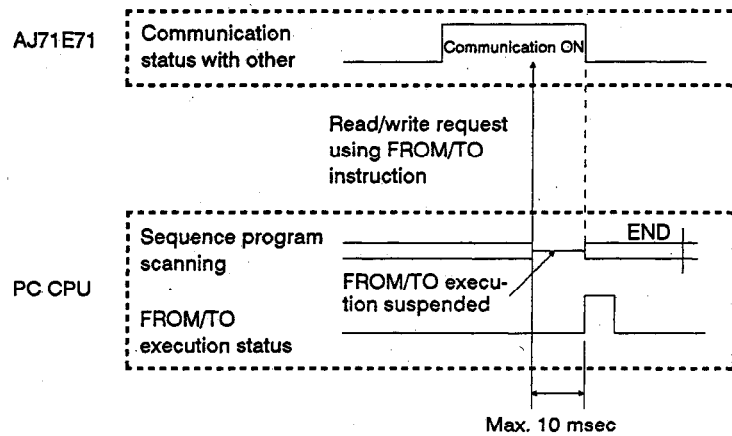

7. COMMUNICATION PROCESSING USING RANDOM ACCESS BUFFER MEMORY AREA

MELSEC-A

7.1.1 Communication control in response to read request from other node

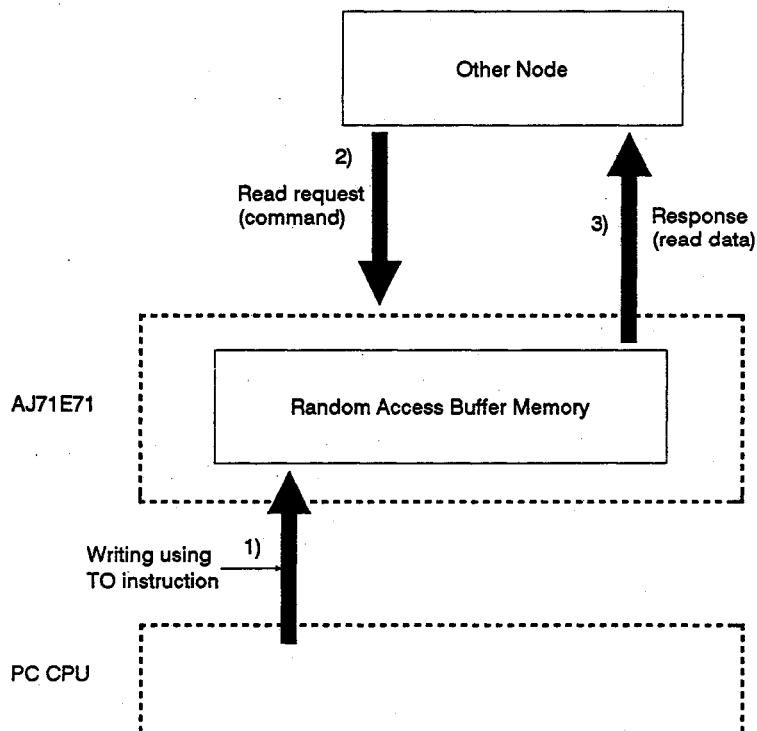

- (1) Write data to AJ71E71 random access buffer memory area using a TO instruction in a sequence program.

Write data to AJ71E71 random access buffer memory area from other node.

- (2) Transmit the read request signal from the node that is to read the contents in the random access buffer memory area to the AJ71E71.
- (3) Receiving the read request from the node, the AJ71E71 transmits the data stored in the random access buffer memory area as the response.

POINT

In the communications using random access buffer memory area, communications is possible only with the node for which the communication line open complete signal (X10 to X17) is ON.

7. COMMUNICATION PROCESSING USING RANDOM ACCESS BUFFER MEMORY AREA

MELSEC-A

7.1.2 Communication control in response to write request from other node

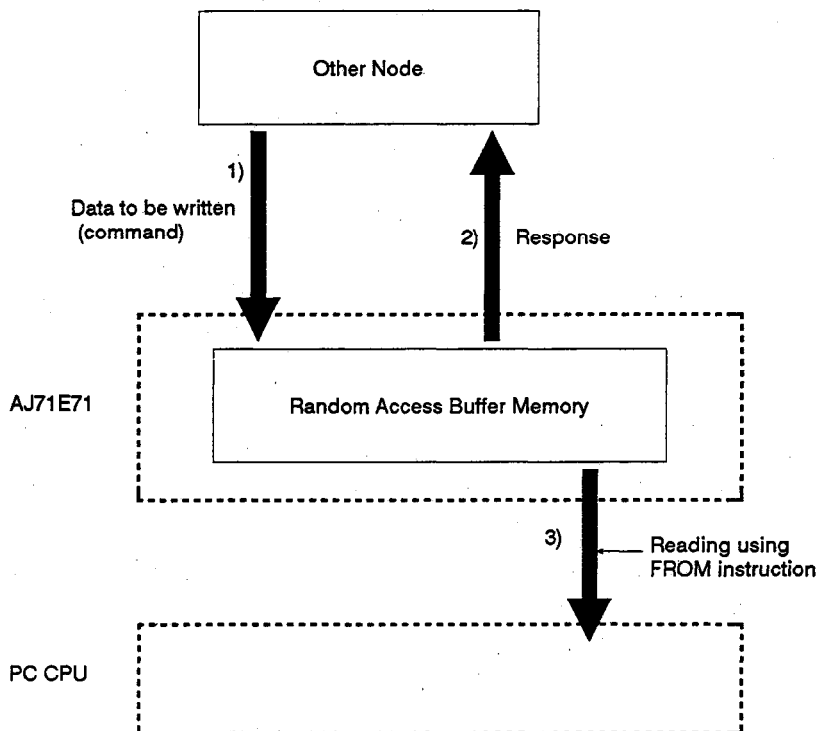

- (1) Write data to AJ71E71 random access buffer memory area from other node.
- (2) Upon receiving data from other node, the AJ71E71 returns "response" to the node that has transmitted data.
- (3) Read data received to the random access buffer memory area using a FROM instruction in a sequence program.

It is also possible to read received data from the random access buffer memory area by other node.

POINT

In the communications using random access buffer memory area, communications is possible only with the node for which the communication line open complete signal (X10 to X17) is ON.

7. COMMUNICATION PROCESSING USING RANDOM ACCESS BUFFER MEMORY AREA

MELSEC-A

7.2 Data Format

Communications data consists of "header" and "application data" as explained below.



Max. 2044 bytes

The header for TCP/IP or UDP/IP of Ethernet/Cherapernet. Since the AJ71E71 automatically sets the header in front of the application data, the user does not have to set the header.

7.2.1 Application data format

The application data format varies depending on which code (binary or ASCII) will be used.

Whether the binary or ASCII code is used is set with the dip switches on the front panel of the AJ71E71. Section 4.3.3 gives setting details.

Communications in binary code:

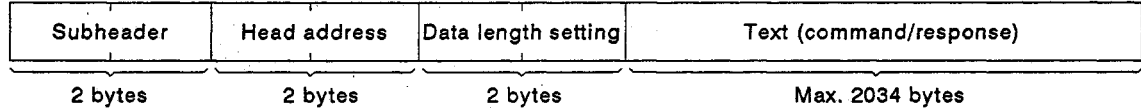

Communications in ASCII code:

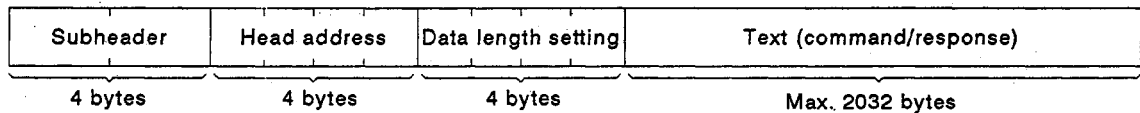

7. COMMUNICATION PROCESSING USING RANDOM ACCESS BUFFER MEMORY AREA

MELSEC-A

7.2.2 Subheader

Since the subheader is automatically set by the AJ71E71, the user does not have to set the subheader.

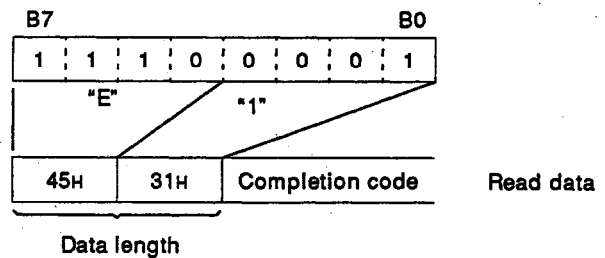
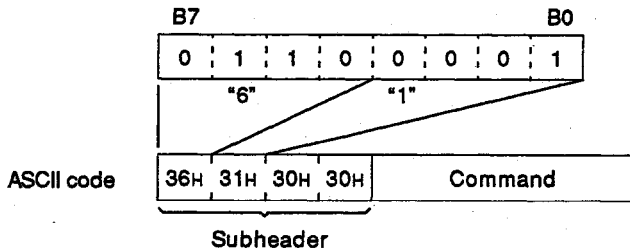
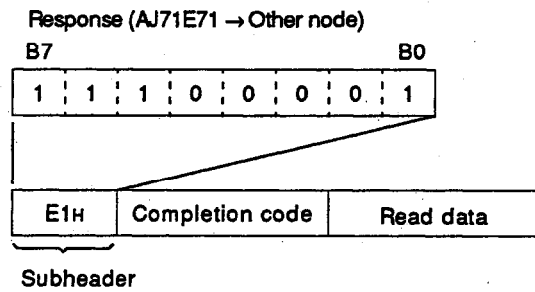
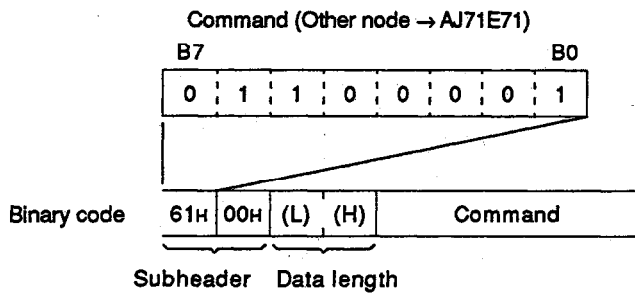
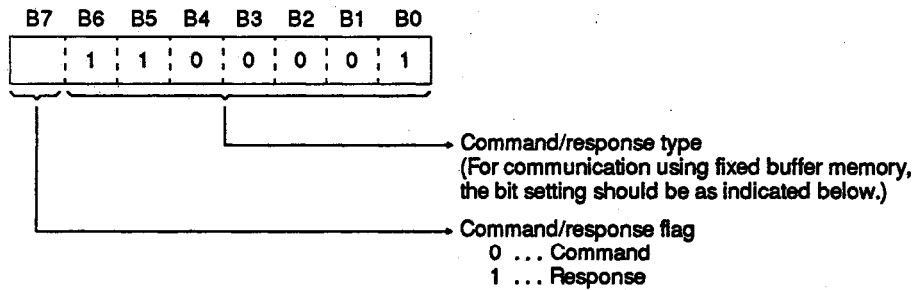

7. COMMUNICATION PROCESSING USING RANDOM ACCESS BUFFER MEMORY AREA

MELSEC-A

7.2.3 Command/Response format

(1) Writing data to buffer memory area by write request from other node

Binary Code Designation

(a) Command format (other node → AJ71E71)

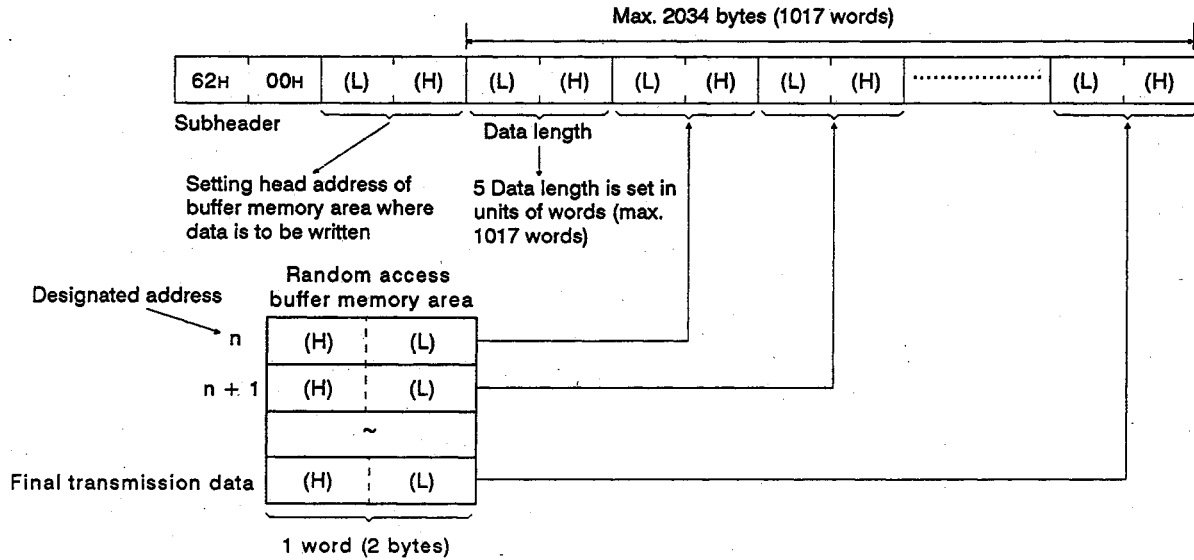

(b) Response format (AJ71E71 → other node)

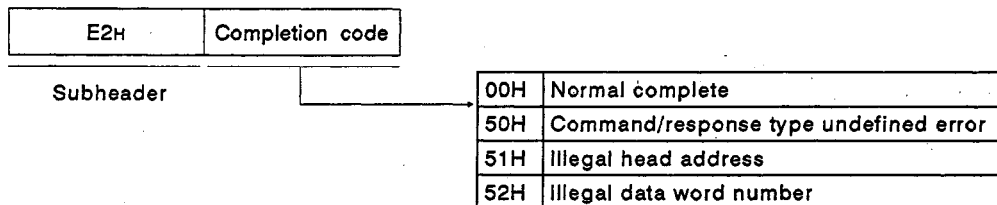

For details, see Section 7.2.4

REMARK

Since the subheader is automatically set by the AJ71E71, the user does not have to set the subheader.

7. COMMUNICATION PROCESSING USING RANDOM ACCESS BUFFER MEMORY AREA

MELSEC-A

ASCII Code Designation

(a) Command format (other node → AJ71E71)

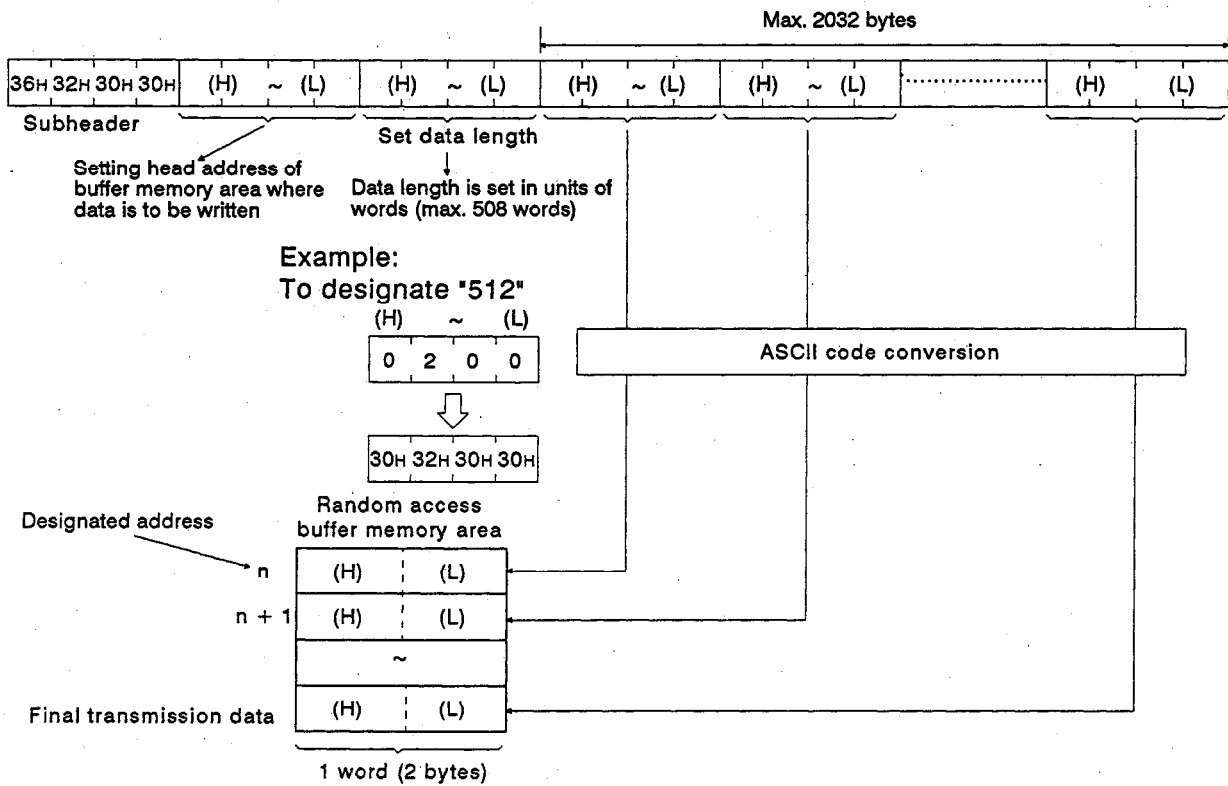

Example:

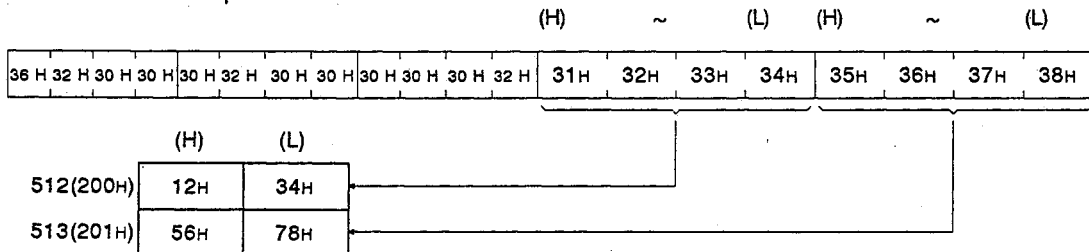

(b) Response format (AJ71E71 → other node)

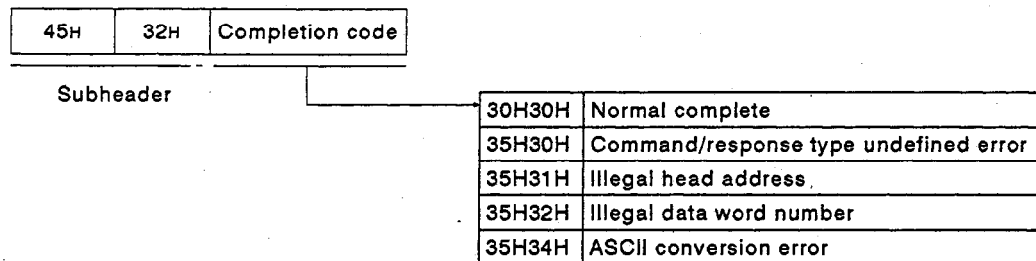

For details, see Section 7.2.4

REMARK

Since the subheader is automatically set by the AJ71E71, the user does not have to set the subheader.

7. COMMUNICATION PROCESSING USING RANDOM ACCESS BUFFER MEMORY AREA

MELSEC-A

(2) Transmitting data by read request from other node

Binary Code Designation

(a) Command format (other node → AJ71E71)

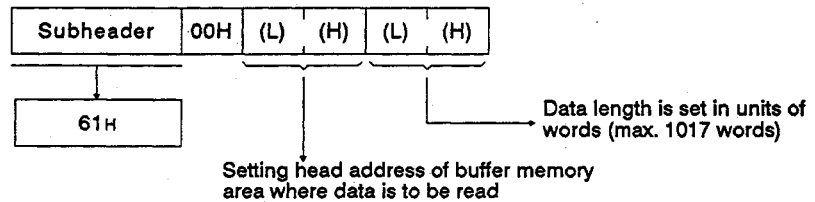

Example: To designate '100'

100 = 64H

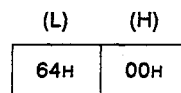

(b) Response format (AJ71E71 → other node)

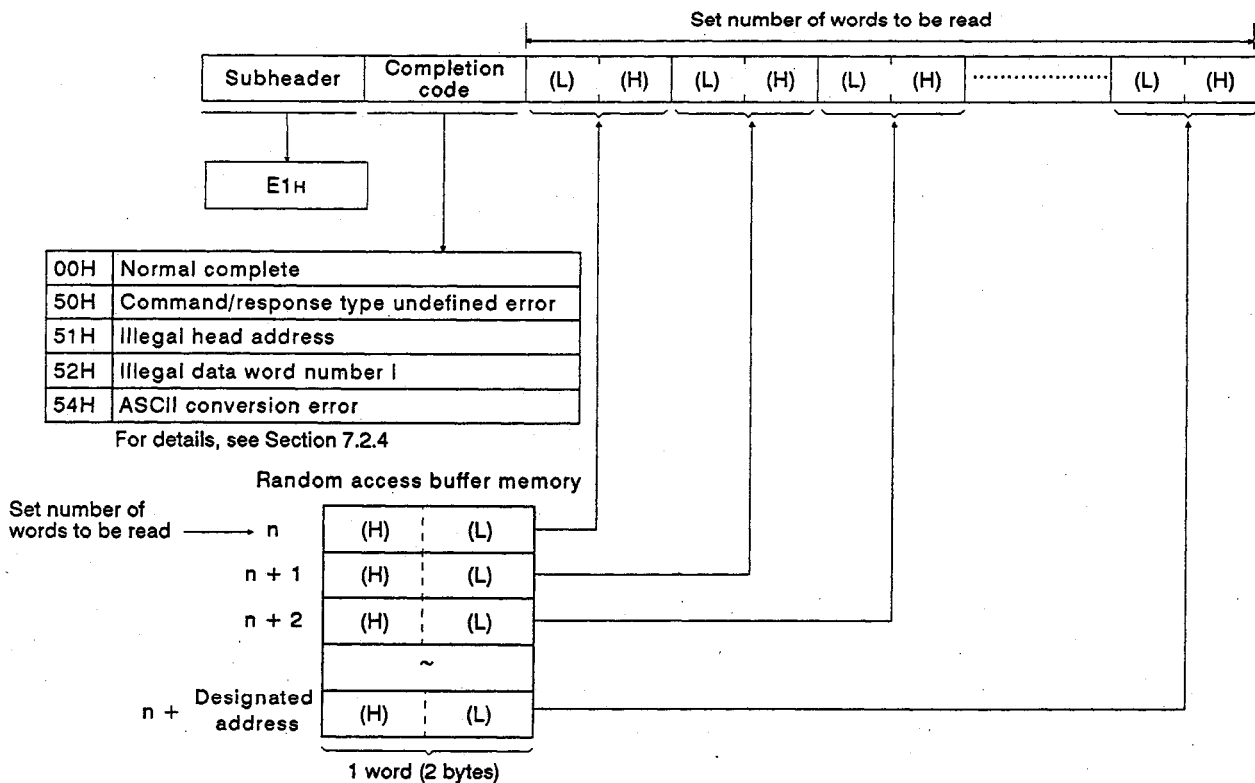

REMARK

Since the subheader is automatically set by the AJ71E71, the user does not have to set the subheader.

7. COMMUNICATION PROCESSING USING RANDOM ACCESS BUFFER MEMORY AREA

MELSEC-A

ASCII Code Designation

(a) Command format

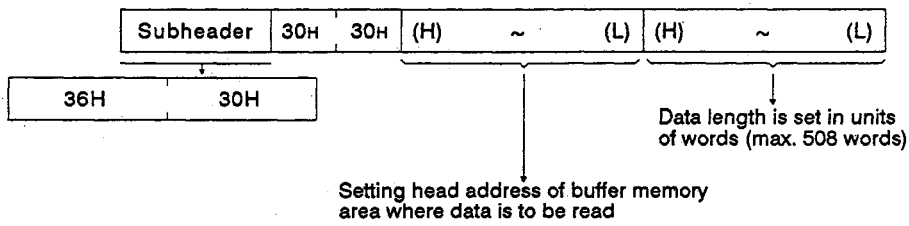

Example: To designate "100"

100 = 64 H

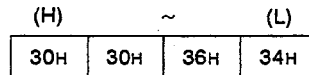

(b) Response format

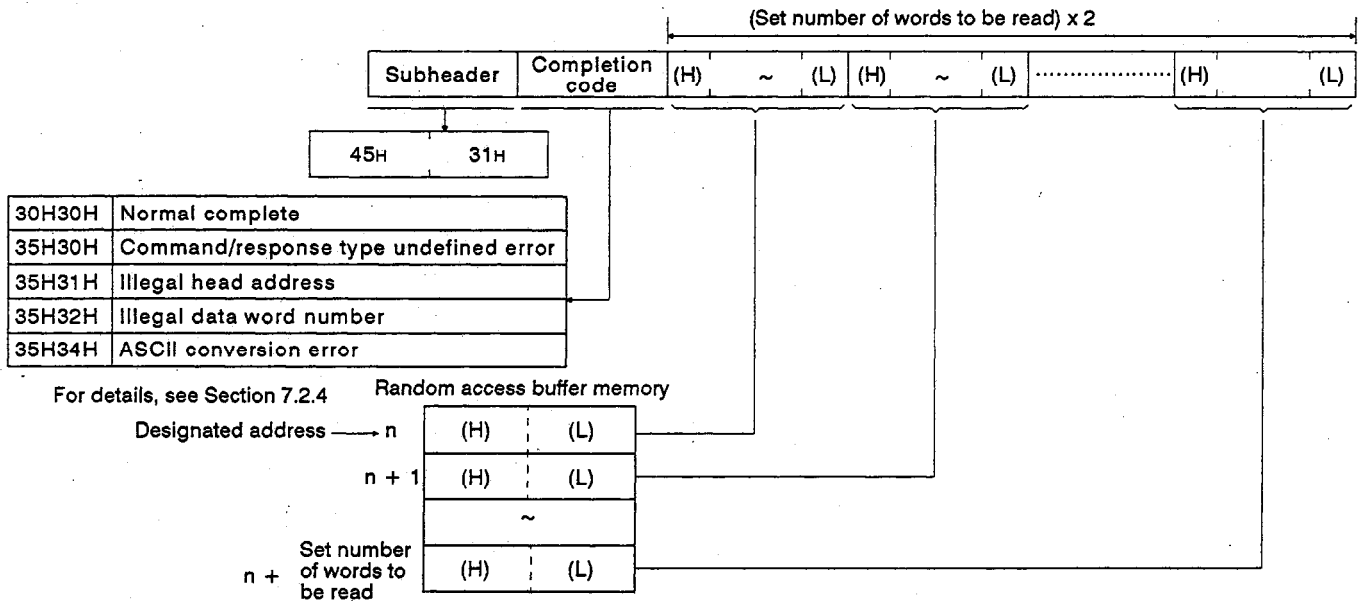

Example:

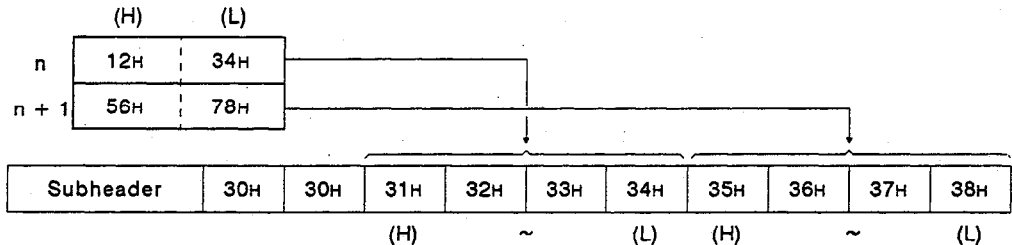

REMARK

Since the subheader is automatically set by the AJ71E71, the user does not have to set the subheader.

7. COMMUNICATION PROCESSING USING RANDOM ACCESS BUFFER MEMORY AREA

MELSEC-A

7.2.4 List of end codes

Completion Code	Description	Corrective Action								
00H	Normal completion	-								
50H	<p>The command/response type in the subheader is not allowable code.</p> <table border="1"> <thead> <tr> <th>Communications Processing</th> <th>Command/Response Type</th> </tr> </thead> <tbody> <tr> <td>Communications using fixed buffer memory</td> <td>60H</td> </tr> <tr> <td>Communications using random access buffer memory</td> <td>61H, 62H</td> </tr> <tr> <td>Read/write of data in PC CPU</td> <td>00H to 3CH</td> </tr> </tbody> </table>	Communications Processing	Command/Response Type	Communications using fixed buffer memory	60H	Communications using random access buffer memory	61H, 62H	Read/write of data in PC CPU	00H to 3CH	<ul style="list-style-type: none"> Check the command/response type set by the communicating node and make corrections as necessary. Since the command/response type is automatically set by the AJ71E71, the user does not have to set the command/response type.
Communications Processing	Command/Response Type									
Communications using fixed buffer memory	60H									
Communications using random access buffer memory	61H, 62H									
Read/write of data in PC CPU	00H to 3CH									
51H	When random access buffer is used, the head address by the communicating node is outside the range of 0 to 6143.	Check and correct the head address and the number of data words.								
52H	<p>When random access buffer is used, the data length of the head address set by the communicating node and data words* is outside the range of 0 to 6143.</p> <p>*The number of data words is set when a read operation is done. Data of the designated number of words cannot be transmitted in one frame.</p> <p>The following lengths are excessive: 1017 words for binary code 508 words for ASCII code</p>	Check and correct the number of data words of the communicating station.								
54H	If the AJ71E71 code setting is ASCII, an ASCII code that cannot be converted into the binary code is transmitted from the communicating station.	Check and correct the send data of the communicating station.								

7. COMMUNICATION PROCESSING USING RANDOM ACCESS BUFFER MEMORY AREA

MELSEC-A

7.3 Data Storing Area

Random access buffer memory area (not battery backed up) of AJ71E71 is explained below.

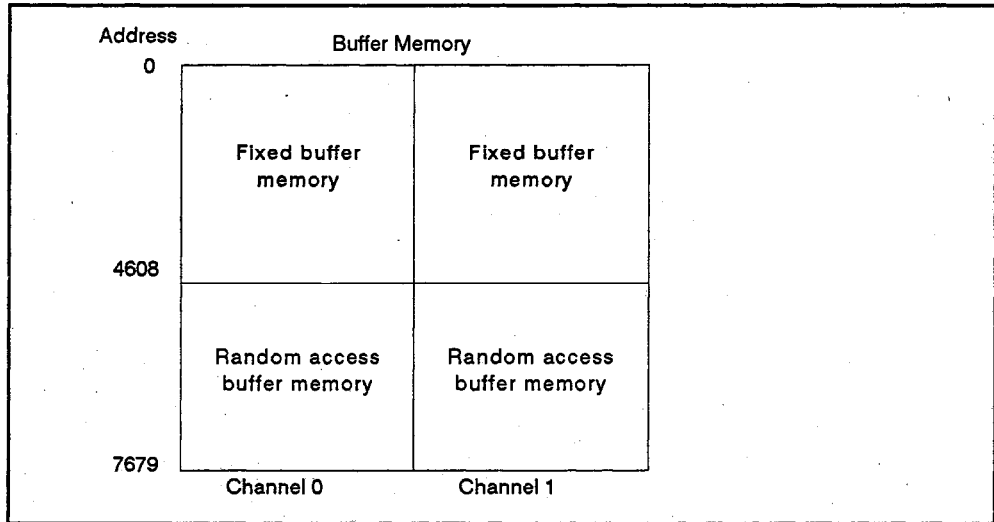

Random access buffer memory address is indicated below.

The address used to designate random access buffer memory area differs between the address designated by other node and the address designated by FROM/TO instruction in a sequence program.

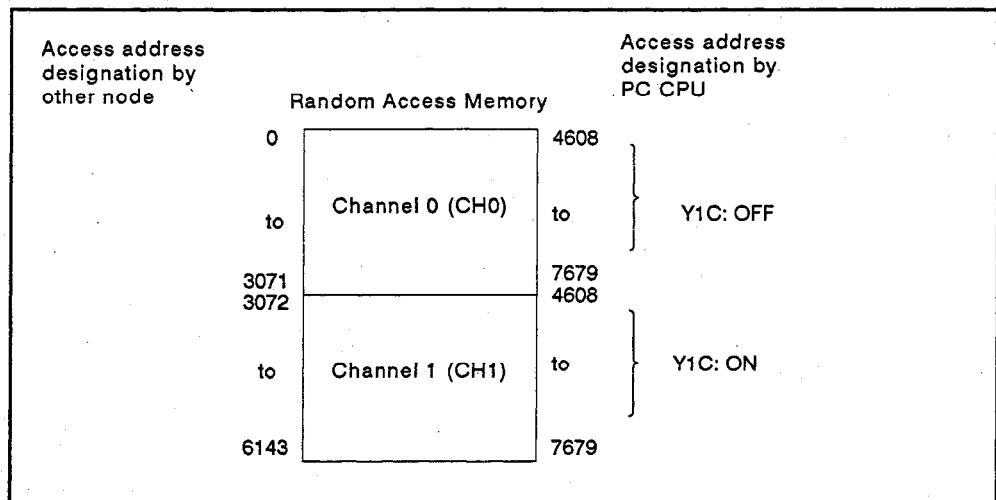

- (1) For read/write from other node, it is not necessary to change the channel because continuous 6K word area is used.

For read/write operation using FROM/TO instruction in a sequence program, it is necessary to change the channel by turning ON/OFF the AJ71E71's I/O signal Y1C (channel change signal).

Y1C OFF.....Channel 0
Y1C ONChannel 1

- (2) (b) One address corresponds to 2 bytes.

7.4 Programming

7.4.1 Cautions on programming

- (1) Communications using the random access buffer memory area are executed in asynchronous with a sequence program.

Therefore, handshake cannot function between data read/write at random access buffer memory area by PC CPU and data communications.

- (2) For communications using random access buffer memory area, address to be designated from other node and the address to be designated with FROM/TO instruction differ from each other. For details, see Section 7.3.

7. COMMUNICATION PROCESSING USING RANDOM ACCESS BUFFER MEMORY AREA

MELSEC-A

7.4.2 Programming procedure

For communications using random access buffer memory area, the following three communication methods are available:

- (1) Data written to random access buffer memory area by node A is read by node B.
- (2) Data written to random access buffer memory area by a sequence program is read by a node.
- (3) Data written to random access buffer memory area by a node is read by a sequence program.

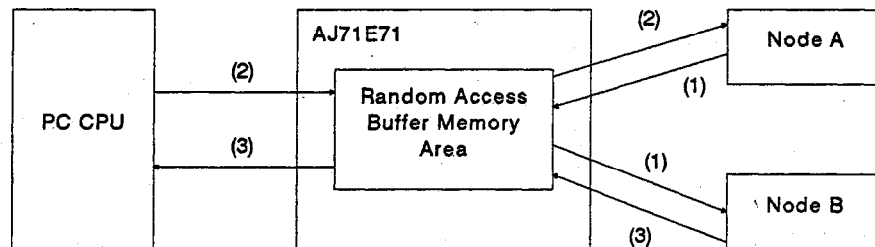

Details of the above indicated three communication methods are described below.

- (1) Data written by node A is read by node B:

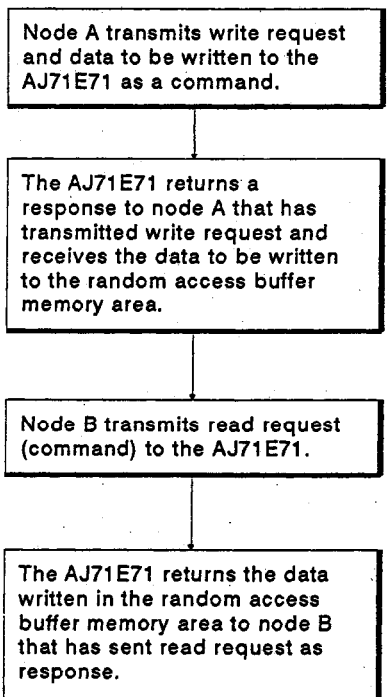

For details of command and response formats, see item (1) in Section 7.2.3.

For details of command and response formats, see item (2) in Section 7.2.3.

7. COMMUNICATION PROCESSING USING RANDOM ACCESS BUFFER MEMORY AREA

MELSEC-A

(2) Data written by a sequence program is read by a node:

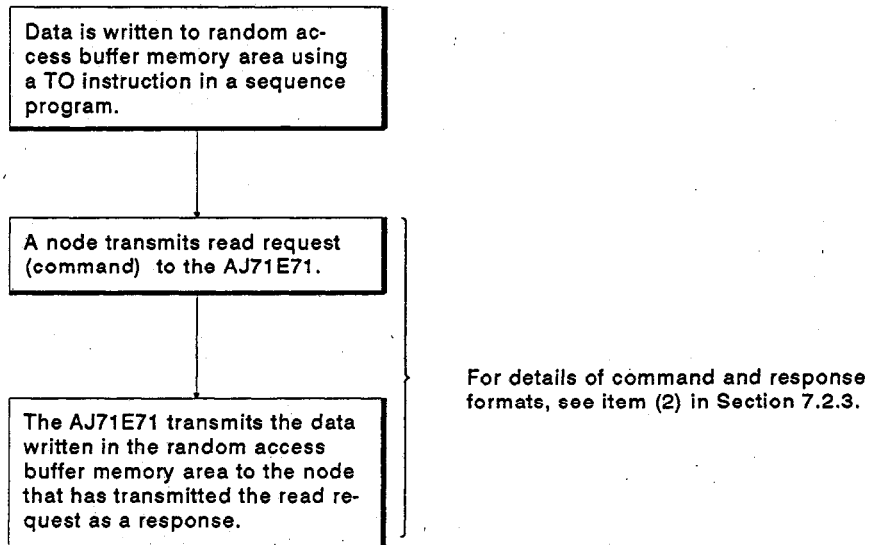

REMARK

In communications using random access buffer memory area, handshake using the AJ71E71 input/output signals.

(3) Data written by a node is read by a sequence program:

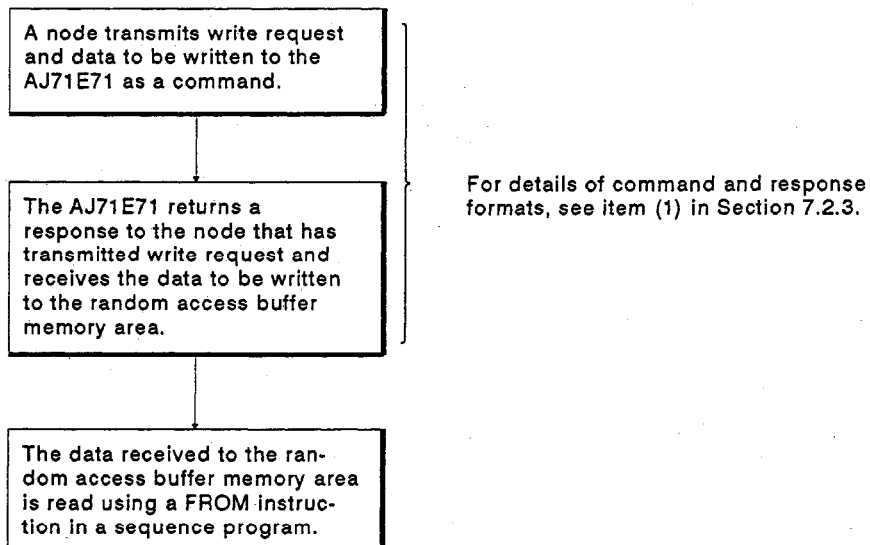

REMARK

In communications using random access buffer memory area, handshake using the AJ71E71 input/output signals.

8. READING AND WRITING DATA STORED IN THE PC CPU **MELSEC-A**

8. READING AND WRITING DATA STORED IN THE PC CPU

When data of a device and a program in the PC CPU is read and written through AJ71E71 from the communicating node, follow the control method and data format below.

8.1 Control Method

When data in the PC CPU is read and written, use the following control method:

- (1) Data in the PC CPU can be read and written. It is not related to the use of the ON/OFF state of the I/O number of AJ71E71 and the sequence program.
- (2) Writing enable/disable in PC CPU RUN can be selected by a CPU communications timing setting switch in front of AJ71E71 in case of the writing from the node to the PC CPU.

Communications timing setting switch (Refer to Section 4.3.3.)

SW7 OFF : Writing cannot be done from the communicating node during PC CPU RUN.

ON : Writing can be done from the node that communicates during PC CPU RUN or STOP.

POINT

When writing is done to the special-function module loaded with a remote I/O station in MELSECNET(II) from the communicating node, set communications timing setting switch (SW7) at ON.

A remote I/O station is always set to a RUN state.

RUN/STOP cannot be switched.

8. READING AND WRITING DATA STORED IN THE PC CPU MELSEC-A

8.1.1 Communications with a PC CPU which is loaded with an AJ71E71

- (1) When data in the PC CPU loaded with AJ71E71 is read and is written, use the following method of control:

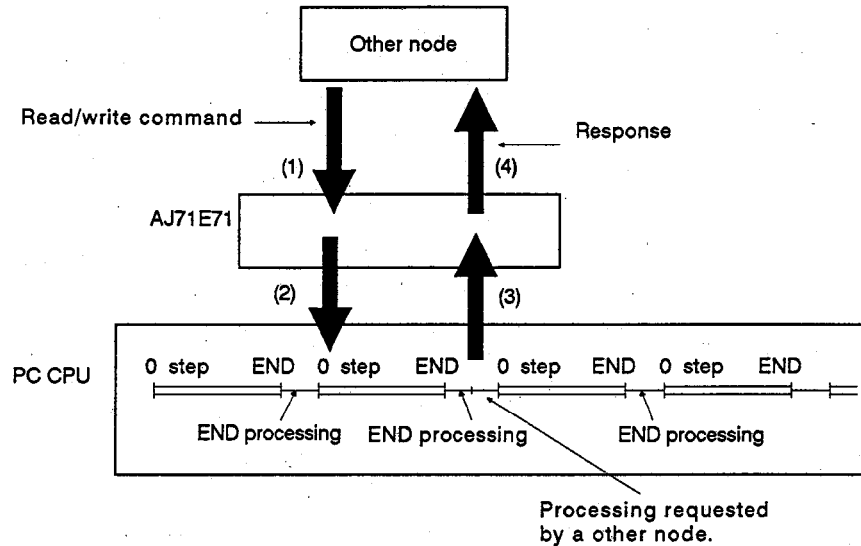

- (a) A communicating node sends a command to the AJ71E71 to read/write data in the PC CPU.
- (b) Upon receiving the command, the AJ71E71 makes a request to read/write the data in the PC CPU.
- (c) The PC CPU executes the read/write processing according to the request when the END instruction execution of the sequence program is completed.
Then, the result of the processing is transferred to the AJ71E71.
- (d) Upon receiving the result of the processing from the PC CPU, the AJ71E71 sends a response which contains the result to the other node.

POINT

When read/write from the node is done during PC CPU RUN, time that is necessary for the processing for the command from the node is added in a scan time of a sequence program.

8. READING AND WRITING DATA STORED IN THE PC CPU MELSEC-A

8.1.2 Communications with a PC CPU in MELSECNET

- (1) Read/write processing of data in a local station PC CPU can be requested from a mode in other network via the PC CPU loaded with an AJ71E71, as shown below.

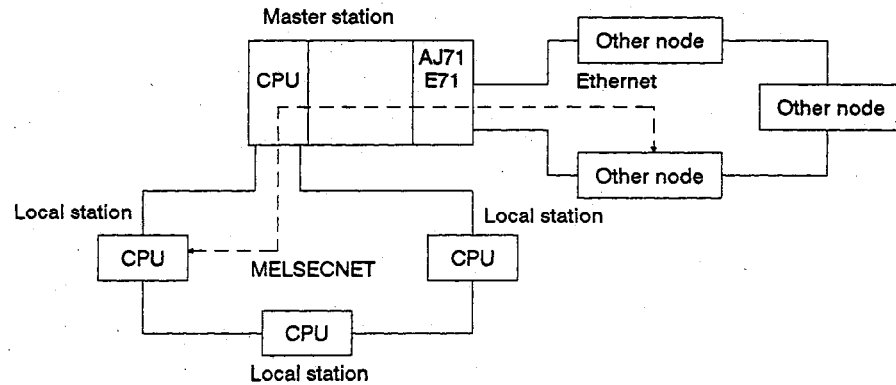

- (2) When data in the PC CPU in MELSECNET is read and written, set the PC number of a PC CPU at a command.
- (3) The PC number specifies a communicating PC CPU in MELSECNET.

Set the PC number to FFH or set it within the range from 00H to 40H (0 to 64) as follows.

FFH When a communications is done for a PC CPU with AJ71E71

00H When AJ71E71 loaded with the MELSECNET local station communicates with the MELSECNET master station

1 to 40H When AJ71E71 loaded with the MELSECNET master station communicates with the MELSECNET local station or a remote I/O station (1 to 64)

Set station number (1 to 64) set at a local station or remote I/O station.

8. READING AND WRITING DATA STORED IN THE PC CPU MELSEC-A

(4) Communicating PC CPUs in MELSECNET

The following PC CPUs can be used as communicating nodes in the MELSECNET. Communicating PC CPUs that can be used depend upon the location of stations loaded with an AJ71E71.

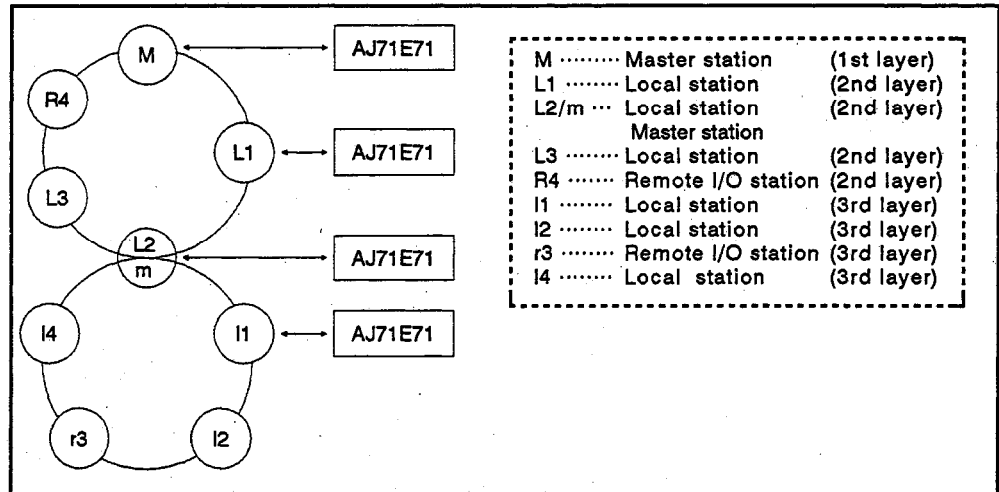

PC CPU with AJ71E71	PC that can be Linked (PC Number)									
	The self (FF)	M (0)	L1 (1)	L2/m (2/0)	L3 (3)	R4 (4)	I1 (1)	I2 (2)	r3 (3)	I4 (4)
M	o	—	o	o	o	o*1	x	x	x	x
L1	o	o	—	x	x	x	x	x	x	x
L2/m	o	o	x	—	x	x	o	o	o*1	o
I1	o	x	x	o	x	x	—	x	x	x

o All devices can be accessed by setting the PC number of a PC.

o*1... A special-function module buffer memory can be accessed by setting the PC number of a PC.

POINT

Communications with A0J2CPUP23/R23 and A0J2P25/R25 cannot be done.

8. READING AND WRITING DATA STORED IN THE PC CPU MELSEC-A

- (5) When data in the PC CPU of the other in MELSECNET is read and written, data flows as follows:

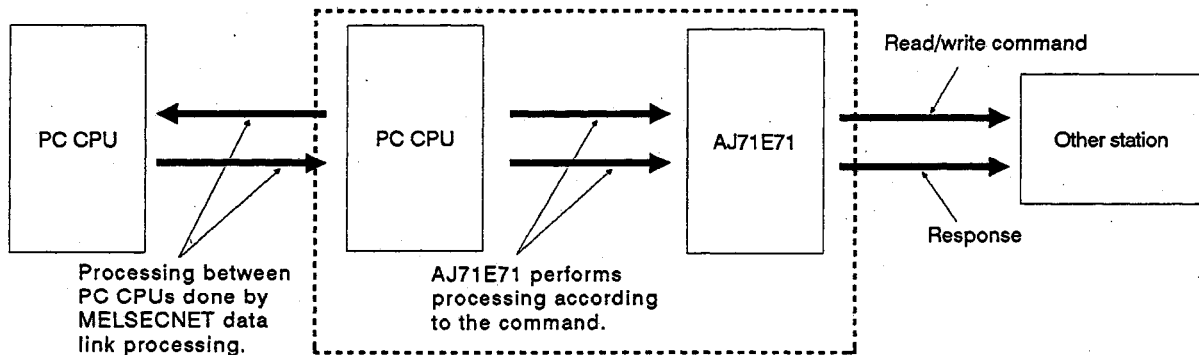

- (6) Transmission time through MELSECNET

- (a) When the PC number is specified for a PC CPU without AJ71E71 on MELSECNET, and a data transmission is done, transmission time (T1) is as follows:

● Local station

Transmission time (T1) = (LRDP instruction processing time) + (Scan time with AJ71E71) × 1

● Remote I/O station

Transmission time (T1) = (1 RFRP instruction processing time + MELSECNET master station scan time) × 1

As for in the above-mentioned formula, when a communications is first done at the time of a power on or after CPU reset, use "3".

● Factor that delays transmission time (T1)

When the transmission time of a certain command (writing of device R, etc.) needs 2 scans, the transmission time becomes the double of the above-mentioned value.

When the other of the link is being monitored by using A6GPP, the transmission time becomes the double per monitor.

- When a device is read through MELSECNET, lengthen the monitoring time of the ACPU watchdog timer of the other.

* As fo details of data link, refer to MELSECNET (II) Reference Manual

8. READING AND WRITING DATA STORED IN THE PC CPU MELSEC-A

Example: When the MELSECNET master station is loaded with AJ71E71, and the device memory of a local station is read

(Condition L LS M, M: 80 msec, $\alpha 1$: 10 msec)

Transmission time (T1) =

$$(M \times 4 + \alpha 1 \times 4 + M) = (80 \times 4 + 10 \times 4 + 80) \times 1 = 440$$

T1 is 440 msec.

M : MELSECNET master station scan time

$\alpha 1$: MELSECNET master station link refresh time

LS : Link scan time

L : MELSECNET local station scan time

POINT

A condition slows the data transmission time of a PC CPU without AJ71E71 on MELSECNET considerably.

Use only station (PC number FFH) with AJ71E71 for the communications between the other and a PC CPU, and use data link (B, W) of MELSECNET for the communications with other PC CPU. As a result a transmission delay time decreases.

8. READING AND WRITING DATA STORED IN THE PC CPU

MELSEC-A

8.2 Communicating Data

When read/write of data in the PC CPU is done, table 8.1 shows data that can be read and written from the other.

Table 8.1 Communicating Data

Function		Command/ Response Classifica- tion	Description	Number of Point Processed per Com- munications	PC CPU State			Refer- ence	
					During STOP	During RUN SW22 ON	SW22 OFF		
Device memory	Batch read	Bit units	00H	Reads bit devices (such as X, Y, M) in units of 1 device.	256 points				8.4.2
		Word units	01H	Reads bit devices (such as X, Y, M) in units of 16 devices.	128 words (2048 points)	o	o	o	8.4.3
		Reads word devices (such as D, R, T, C) in units of 1 device. *2		256 points					
	Batch write	Bit units	02H	Writes bit devices (such as X, Y, M) in units of 1 device.	256 points				8.4.4
		Word units	03H	Writes bit devices (such as X, Y, M) in units of 16 devices.	40 words (640 points)	o	o	x	8.4.5
		Writes word devices (such as D, R, T, C) in units of 1 device.		256 points					
	Test (random write)	Bit units	04H	Specifies bit devices (such as X, Y, M) and device number in units of 1 device at random and sets/resets the device.	80 points				8.4.6
		Word units	05H	Specifies bit devices (such as X, Y, M) and device number in units of 16 devices at random and sets/resets the device.	40 words (640 points)	o	o	x	8.4.7
				Specifies word devices (such as D, R, T, C) and device number in units of 1 device at random and sets/resets the device.	40 points				
	Monitor data regist- ration	Bit units	06H	Sets bit devices to be monitored (such as X, Y, M) in units of 1 device.	40 points *1				8.4.8
		Word units	07H	Sets bit devices to be monitored (such as X, Y, M) in units of 16 devices.	20 words *1 (320 points)	o	o	o	
				Sets word devices to be monitored (such as D, R, T, C) in units of 1 device.	20 points				
Monitor	Bit units	08H	Reads data from devices for which device data has been registered.	-	o	o	o		
	Word units	09H							
Extension file register	Batch read	17H	Reads extension file registers (R) in units of 1 register.	256 points	o	o	o	8.5.3	
	Batch write	18H	Writes extension file registers (R) in units of 1 register.	256 points	o	o	x	8.5.4	
	Test (random write)	19H	Specifies the extension file registers (R) in units of 1 register using block or device number and makes a random write.	40 points	o	o	x	8.5.5	
	Monitor data registration	1AH	Sets the extension file registers (R) device number and makes a random write.	20 points	o	o	o	8.5.6	
	Monitor	1BH	Monitors the extension file register (R) after monitor data registration.	-	o	o	o		
	Direct read	3BH	Reads extension file registers (R) in units of 1 register.	256 points	o	o	o	8.5.7	
	Direct write	3CH	Writes extension file registers (R) in units of 1 register.	256 points	o	o	x	8.5.7	
Special function module	Batch read	0EH	Reads the contents of the special function module buffer memory.	256 points (128 words)	o	o	o	8.6.3	
	Batch write	0FH	Writes the contents of the special function module buffer memory.		o	o	x	8.6.4	

o : Available
x : Unavailable

*1 When a CPU except A3HCPU and A2A(S1), A3A is used, the number of device points processed at one time is the half of the above-mentioned value of device X (input).

*2 When read/write of an extensive file register is done, use a dedicated instruction of an extensive register.

8. READING AND WRITING DATA STORED IN THE PC CPU MELSEC-A

Table 8.1 Communicating Data (Continued)

Function			Command/ Response Classifica- tion	Description	Number of Point Processed per Communica- tions	PC CPU State			Refer- ence	
						During STOP	During RUN SW22 ON	SW22 OFF		
Sequence Program	Batch read	Main	Sequence program	0AH	Reads main sequence programs.	256 steps	o	o	o	8.8.4
			T/C set value		Reads T/C set values used in main sequence programs.	256 points				
		Sub	Sequence program	0BH	Reads subsequence programs.	256 steps	o	o	o	
			T/C set value		Reads T/C set values used in subsequence programs.	256 points				
	Batch write	Main	Sequence program	0CH	Writes main sequence programs.	256 steps	o	o*3	x	
			T/C set value		Writes T/C set values used in main sequence programs.	256 points				
		Sub	Sequence program	0DH	Writes subsequence programs.	256 steps	o	o	x	
			T/C set value		Writes T/C set values used in subsequence programs.	256 points				
Micro comuter program	Batch read	Main	1EH	Reads main micro- computer programs.	256 bytes	o	o	o	8.8.5	
		Sub	1FH	Reads submicro- comuter programs.						
	Batch write	Main	20H	Writes main micro- computer programs.		o	o*3	x		
		Sub	21H	Writes submicro- computer programs.						
Comment	Batch read		1CH	Reads comment data.	256 bytes	o	o	o	8.8.6	
	Batch write		1DH	Writes comment data.						
Extension file register	Direct read		39H	Reads the extension comment data.	256 bytes	o	o	o	8.8.7	
	Direct write		3AH	Writes the extension comment data.	256 bytes					o
Parameter	Batch read		10H	Reads parameters from PC CPU.	256 bytes	o	o	o	8.8.8	
	Batch write		11H	Writes parameters to PC CPU.						
	Analysis request		12H	Causes PC CPU to ac- knowledge and check rewritten parameters.	-	o	x	x		
PC CPU	Remote RUN		13H	Request remote run/stop of PC CPU.	-	o	o	o	8.7.2	
	Remote STOP		14H							
	PC CPU read		15H	Reads the type of PC CPU: A1N, A2N, A3N, A3H		o	o	o	8.7.8	
Loopback test			16H	Echoes unchanged characters back to the computer.	256 bytes	o	o	o	8.8	

o : Available
x : Unavailable

*3 When all the following conditions are satisfied, a program can be written during RUN:

- (1) A PC CPU must be A3, A3N, A3H, A2A(S1) or A3A.
- (2) A program must be the program that is not used at present.
(The main program is a subprogram during RUN.)
- (3) A special relay of a PC PCU must be the following state
 - (a) M9050 (signal flow exchange contact) OFF (only A3CPU)
 - (b) M9051 (CHG instruction execution disabled) ON

8. READING AND WRITING DATA STORED IN THE PC CPU MELSEC-A

8.3 Data Format

When communications between AJ71E71 and a communicating node is done, use the following data format.

As shown below, communication data is composed of a header and application data.

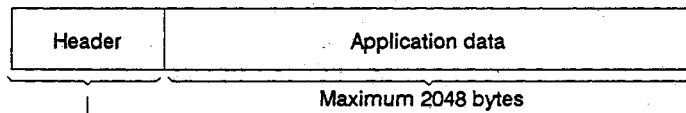

The header is for TCP/IP and UDP/IP of Ethernet/Chepernet. AJ71E71 adds a header to a head of application data automatically in case of AJ71E71. Therefore the user does not have to set a header.

8.3.1 Application data format

As shown below, the application data format is divided into subheader and a text.

A subheader sets the type of each function.

The set value is decided on according to a function to be used.

The text sets request data (command) and reply data (response) for each function.

Set data by using a specified format.

As for the details, refer to Section 8.4 and after.

Communications in binary code

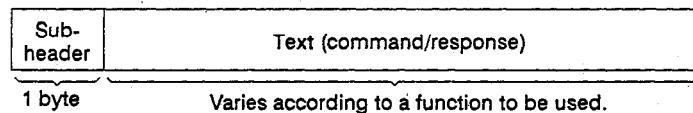

Communications in ASCII code

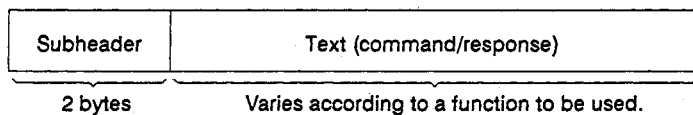

REMARK

The response for the command from the other node is set automatically in AJ71E71 in case of data read/write in the PC CPU.

Therefore the user does not have to set this.

8. READING AND WRITING DATA STORED IN THE PC CPU MELSEC-A

8.3.2 Subheader

The format of a subheader is composed as follows:

When AJ71E71 sends a response back for a communicating node, AJ71E71 sets response data automatically. Therefore the user does not have to set this.

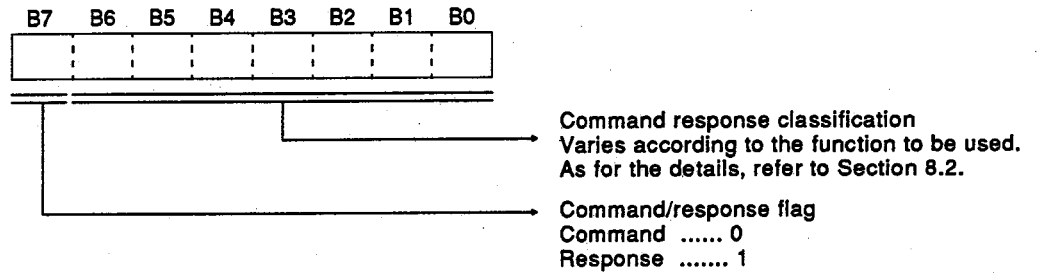

Example: When batch read of a device memory is done in a word units (Command/response classification of a device memory batch read (word units) ...01-)

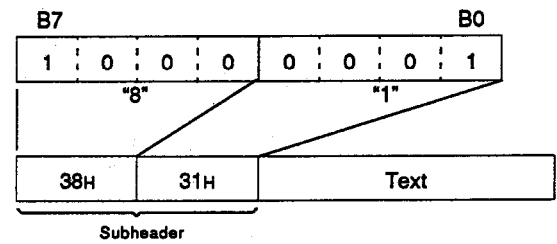
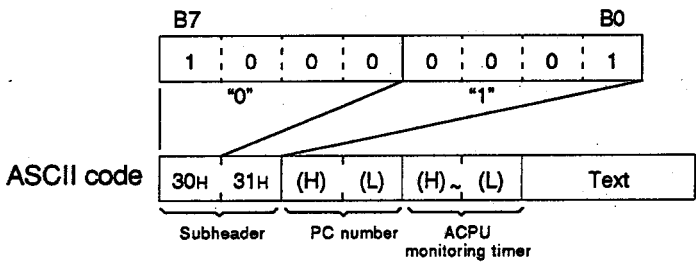
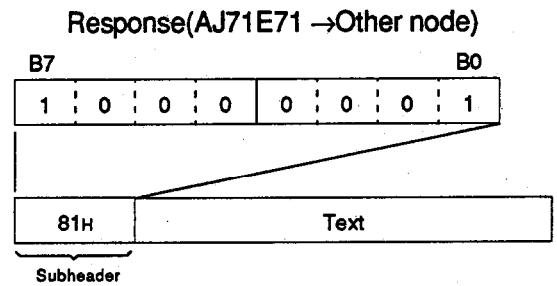
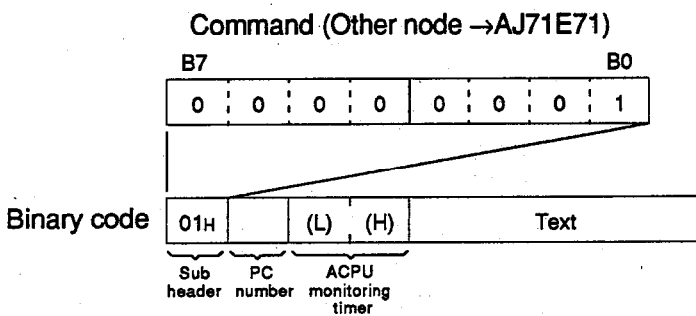

POINTS

- When the ACPU monitoring timer value is set to "0", the CPU becomes an infinite wait state.
- When a data communications with the other in MELSECNET is done, refer to Section 8.1.2.

8. READING AND WRITING DATA STORED IN THE PC CPU MELSEC-A

8.3.3 Completion code

When data in the PC CPU is read and is written, the completion code that AJ71E71 adds to a response by a communications between a other node and AJ71E71 is shown as follows:

Table 8.2 Completion code

Completion Code	Description	Corrective Action								
00H	Normal completion	—								
50H	<p>A command/response classification of a subheader is the code that is not specified.</p> <table border="1" style="width: 100%; border-collapse: collapse;"> <thead> <tr> <th style="width: 50%;">Communications processing</th> <th style="width: 50%;">Command/response classification</th> </tr> </thead> <tbody> <tr> <td>Communications of a fixed buffer</td> <td>60H</td> </tr> <tr> <td>Communications of a random access buffer</td> <td>61, 62H</td> </tr> <tr> <td>Read/write of data in the PC CPU</td> <td>00H to 3CH</td> </tr> </tbody> </table>	Communications processing	Command/response classification	Communications of a fixed buffer	60H	Communications of a random access buffer	61, 62H	Read/write of data in the PC CPU	00H to 3CH	<p>Confirm and modify a command/response classification set in the other node. (AJ71E71 adds a command/response classification automatically. Therefore setting by a user is unnecessary.)</p>
Communications processing	Command/response classification									
Communications of a fixed buffer	60H									
Communications of a random access buffer	61, 62H									
Read/write of data in the PC CPU	00H to 3CH									
54H	The ASCII code that cannot be translated into a binary code when setting the data code of AJ71E71 in the ASCII code has been transmitted from the other node.	Confirm and correct the send data of a other node.								
55H	<ul style="list-style-type: none"> When a DIP switch SW7 in front of AJ71E71 was OFF state (It is write-disabled during RUN), data was written in a PC CPU during PC CPU RUN from the other node. A parameter, a sequence program and a microcomputer program were written during PC CPU RUN from the other node. (The ON/OFF state of a DIP switch (SW7) in front of AJ71E71 is not related.) 	<ul style="list-style-type: none"> Set SW7 to the ON (write-enabled during RUN). Then, write data. However, a parameter, a sequence program and a microcomputer program cannot be written in a CPU during RUN. Stop a PC CPU. Then, write data. 								
56H	<ul style="list-style-type: none"> There is an error in device specification done from the other node. 	Refer to Section 8.4.1(2), and correct device specification.								
57H	<ul style="list-style-type: none"> A number of device points processed specified by a command transmitted from the other node is larger than the maximum number of device points processed of the processing. The sum of a head address (head device number and head step number) and a specified number of device points processed is larger than the maximum address (device number and step number) of the processing. 	<ul style="list-style-type: none"> Correct a number of specified points or a head address (device number and step number). 								
	<ul style="list-style-type: none"> Length of the byte of a command is not specified length. When data is written, a set number of write data points is different from a specified number of device points processed. 	<ul style="list-style-type: none"> Confirm the data length of a command, and set data again. 								
	<ul style="list-style-type: none"> Though monitoring data is not registered, monitoring was done. 	<ul style="list-style-type: none"> Register monitoring data. 								
	<ul style="list-style-type: none"> The final address of a parameter setting range was specified at the time of read/write of a microcomputer program. 	<ul style="list-style-type: none"> Read/write of a final address cannot be done. Correct a specified address. 								
	<ul style="list-style-type: none"> When specifying block No. of an extensive file register, block No. of the range that exceeds a memory cassette capacity was specified. 	Correct specification of block No.								

Table 8.2 Completion code (Continued)

Completion Code	Description	Corrective Action
58H	<ul style="list-style-type: none"> ● Specification of a head address (head address number and head step number) of a command transmitted from the other node has exceeded the range that can be specified. ● When a microcomputer program and file register (R) were read and were written, a value outside the parameter setting range of a PC CPU was specified. 	<ul style="list-style-type: none"> ● Correct a head address to the value within a range that is possible to set each processing.
	<ul style="list-style-type: none"> ● Block No. of an extensive file register is set at block No. that does not exist. 	<ul style="list-style-type: none"> ● Correct specification of block No..
	<ul style="list-style-type: none"> ● File register (R) was specified for the A1(N) CPU. 	The file register cannot be used in the A1(N) CPU.
	<ul style="list-style-type: none"> ● A word device was specified by using a bit device command. ● A head number of a bit device was specified for a value except the multiple of 16 by using a word device command. 	<ul style="list-style-type: none"> ● Correct a command or a specified device.
59H	<ul style="list-style-type: none"> ● Read/write of an extensive file register was done for the A 1(N) CPU. 	An extensive file register cannot be used in the A1(N) CPU.
5BH	<ul style="list-style-type: none"> ● The PC CPU and AJ71E71 cannot be communicated. ● A PC CPU could not be processed for the request from the other node. 	<ul style="list-style-type: none"> ● Confirm an error code to be added after a completion code, and correct an error place. Refer to Section 8.3.4.
60H	<ul style="list-style-type: none"> ● The communicating time of AJ71E71 and a PC CPU exceeded the ACPU watchdog timer value. 	Lengthen the ACPU watchdog timer value.

8. READING AND WRITING DATA STORED IN THE PC CPU MELSEC-A

8.3.4 Error codes

When the PC CPU fails to execute processing in request to from a communicating node, the following error codes are detected by the PC CPU.

As shown below, the AJ71E71 adds an error code after the completion code of a response and transmits it to the requesting node.

The error code is added only when a completion code is "5B",

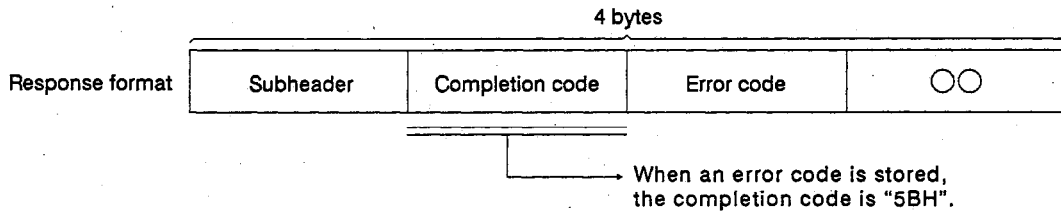

Table 8.3 Error Codes

Error Code (Hexadecimal)	Error Item	Error Description	Corrective Action
10H	PC number error	The station of a specified number PC does not exist. (1) The PC number specified using a command is except "FF" for the self or except a station number set in the MELSECNET link parameter.	(1) Change the PC number to "FF" for the self or a station number set in a link parameter, and retry communications.
11H	Mode error	Communications fault between AJ71E71 and PC CPU (1) After the AJ71E71 received a request from a communicating station normally, communications between the AJ71E71 and the PC CPU was not done normally by some causes (noise, etc.).	(1) Retry communications again. When an error occurs again, check noise, etc., and replace the AJ71E71. Then, retry communications.
12H	Special-function module specification error	Special-function module error (1) A special-function module which has buffer memory for communications was not specified. (For example, an input/output module is loaded in the specified slot or the specified slot is a vacant slot.)	(1) Change the specification of the protocol. Or change the loading position of a special-function module, and retry communications.
13H	Program step No. specification error	Sequence program step No. specification error (1) Specified step No. exceeds the range of a program capacity set in the parameter of a PC CPU.	(1) Specify step No. within a set range. Or change the parameter setting of the PC CPU, and retry communications.
18H	Remote error	Remote RUN/STOP is disabled. Other modules (other AJ71E71s, etc.) have already done a remote STOP/PAUSE.	(1) Check of any other module is not doing a remote STOP/PAUSE. Cancel a remote STOP/PAUSE, and retry communications.
21H	Special-function module bus error	The memory of a special-function module is not accessible. (1) Control bus error with a special-function module (2) A special-function module is malfunctioning.	Hardware error of the PC CPU, base unit, special-function module or AJ71E71. Consult Mitsubishi representatives.

8. READING AND WRITING DATA STORED IN THE PC CPU

MELSEC-A

8.4 Command/Response Format for Read/Write of Device Memory

The following explains the method of control when a device memory is read and written.

8.4.1 Command and device range

(1) Functions to be used for the read/write of device memory

Table 8.4 Functions

Item	Command/ Response Classifica- tion	Description	Number of Point Processed per Com- munications	PC CPU State			
				During STOP	During RUN		
					SW22 ON	SW22 OFF	
Batch read	Bit units	00H	Reads bit devices (such as X, Y, M) in units of 1 device.	256 points			
	Word units	01H	Reads bit devices (such as X, Y, M) in units of 16 devices.	128 words (2048 points)	o	o	o
			Reads word devices (such as D, R, T, C) in units of 1 device.	256 points			
Batch write	Bit units	02H	Writes bit devices (such as X, Y, M) in units of 1 device.	256 points			
	Word units	03H	Writes bit devices (such as X, Y, M) in units of 16 devices.	40 words (640 points)	o	o	x
			Writes word devices (such as D, R, T, C) in units of 1 device.	256 points			
Test (ran- dom write)	Bit units	04H	Specifies bit devices (such as X, Y, M) and device number in units of 1 device at random and sets/resets the device.	80 points			
	Word units	05H	Specifies bit devices (such as X, Y, M) and device number in units of 16 devices at random and sets/resets the device.	40 words (640 points)	o	o	x
			Specifies word devices (such as D, R, T, C) and device number in units of 1 device at random and sets/resets the device.	40 points			
Monitor data regist- ration	Bit units	06H	Sets bit devices to be monitored (such as X, Y, M) in units of 1 device.	*40 points			
	Word units	07H	Sets bit devices to be monitored (such as X, Y, M) in units of 16 devices.	*20 words (320 points)	o	o	o
			Sets word devices to be monitored (such as D, R, T, C) in units of 1 device.	20 points			
Monitor	Bit units	08H	Reads data from devices for which device data has been registered.	-	o	o	o
	Word units	09H					

Number of device points processed marked with *

The number of device points processed per point of device X (input) is 2 points in case of a CPU except A3H, A3M, A2A(S1) and A3A is used.

For example, when device X is included in the specified devices when the monitoring data registration is done with bit unit.

(Number of specified points of X) × 2) +
(Number of specified points of other devices) ≤ 40 points

8. READING AND WRITING DATA STORED IN THE PC CPU

MELSEC-A

(2) Method of specifying a device and range

(a) As for the method of setting each device, use a device code and a device number as follows:

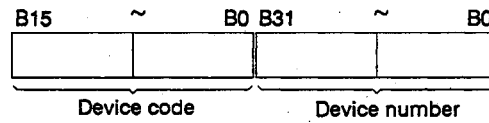

(set in hexadecimal.)

Example: D100

D100 = 4420 00000064H

Device number (hexadecimal)

Device code

(b) Table 8.5 shows device codes and device numbers.

Table 8.5 Device

Device	Device Code	Device Range	Device Number	Applicable CPU								
				A1 A1N	A2 A2N A2C A0J2H	A2-S1 A2N-S1	A3 A3N	A3M	A2A	A2A-S1	A3	
Data register	D0 (44H, 20H)	D0 to D1023	0000h to 03FFh	o	o	o	o	o				
		D0 to D6143	0000h to 17FFh						o	o	o	
		D9000 to D9255	2328h to 2427h	o	o	o	o	o	o	o	o	o
Link register	W0 (57H, 20H)	W0 to W3FF	0000h to 03FFh	o	o	o	o	o				
		W0 to WFFF	0000h to 0FFFh						o	o	o	
File register	R0 (52H, 20H)	R0 to R4095	0000h to 0FFFh		o	o	o	o	o	o	o	o
		R4096 to R8191	1000h to 1FFFh				o	o	o	o	o	o
Timer	Present value	TN (54H, 4EH)	T0 to T255	000h to 00FFh	o	o	o	o	o			
			T0 to T2047	000h to 07FFh						o	o	o
	Contact	TS (54H, 53H)	T0 to T255	000h to 00FFh	o	o	o	o	o			
			T0 to T2047	0000h to 07FFh						o	o	o
	Coil	TC (54H, 43H)	T0 to T255	000h to 00FFh	o	o	o	o	o			
			T0 to T2047	0000h to 07FFh						o	o	o

8. READING AND WRITING DATA STORED IN THE PC CPU

MELSEC-A

Device	Device Code	Device Range	Device Number	Applicable CPU								
				A1 A1N	A2 A2N A2C A0J2H	A2-S1 A2N-S1	A3 A3N	A3M	A2A	A2A-S1	A3	
Counter	Present value CN (43H, 4EH)	C0 to C255	0000h to 00FFh	o	o	o	o	o				
		C0 C1023	0001h to 03FFh						o	o	o	
	Con- tact	CS (43H, 53H)	C0 to C255	0000h to 00FFh	o	o	o	o	o			
			C0 to C1023	0000h to 03FFh						o	o	o
	Coil	CC (43H, 43H)	C0 to C255	0000h to 00FFh	o	o	o	o	o			
			C0 to C1023	0000h to 03FFh						o	o	o
Input	X0 (58H, 20H)	X0 to X0FF	0000h to 00FFh	o								
		X0 to X1FF	0000h to 01FFh		o				o			
		X0 to X3FF	0000h to 03FFh			o					o	
		X0 to X7FF	0000h to 07FFh			o	o				o	
Output	Y0 (59H, 20H)	Y0 to Y0FF	0000h to 00FFh	o								
		Y0 to Y1FF	0000h to 01FFh		o				o			
		Y0 to Y3FF	0000h to 03FFh			o					o	
		Y0 to Y7FF	0000h to 07FFh			o	o				o	
Internal relay	M0 (4DH, 20H)	ML, S0 to ML, S2047	0000h to 07FFh	o	o	o	o	o				
		ML, S0 to ML, S8191	0000h to 01FFh						o	o	o	
		M9000 to M9255	2328h to 2427h	o	o	o	o	o	o	o	o	
Link relay	B0 (42H, 20H)	B0 to B3FF	0000h to 03FFh	o	o	o	o	o				
		B0 to BFFF	000h to 0FFFh						o	o	o	
Annunciator	F0 (46H, 20H)	F0 to F255	000h to 00FFh	o	o	o	o	o				
		F0 to F2047	0000h to 07FFh						o	o	o	

POINTS

- (1) Bit devices and word devices are classified as follows:

Bit device.....X, Y, M, L, B, F, T (contact), T (coil), C (contact), and C (coil)

Word device...T (present value), C (present value), D, W, and R

- (2) The device number of a bit device must be divisible by 16 in case of word unit specification.

- (3) Special relay (M9000 to M9255) and special registers (D9000 to D9255) are classified into the read, write and system areas.

When writing is done to outside a write-enabled range, an error of the PC CPU sometimes occurs.

As for the details of special relays and special registers, see the ACPU Programming Manual.

- (4) When doing read/write of a file register with a PC CPU using an extension file register.

Use a command explained in Section 8.5 Command/Response Format for Read/Write of Extension File Registers.

When an extension file register is used and if device batch read/write processing is done with a file register, read/write may not be done normally.

8. READING AND WRITING DATA STORED IN THE PC CPU MELSEC-A

8.4.2 Batch read in bit unit

When batch read of bit device memory is done, the command and response format are as follows:

(1) Communications in binary code

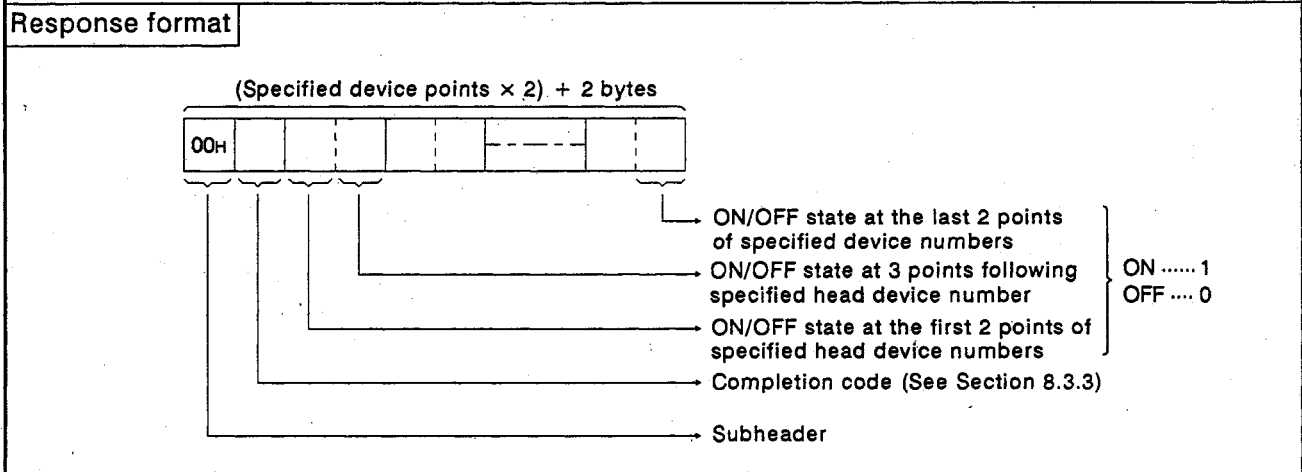
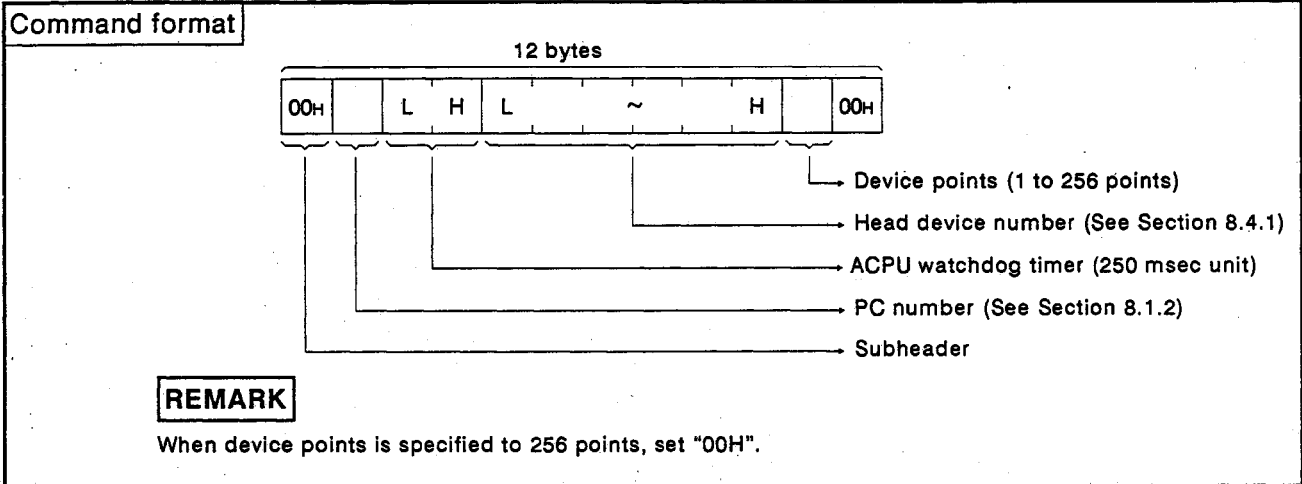

Example: When reading the ON/OFF state of M100 to M111 of a PC CPU loaded with AJ71E71

Command (Other station → AJ71E71)

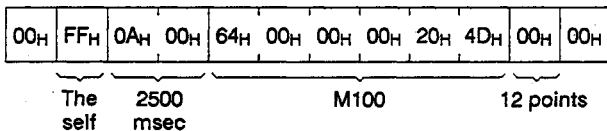

Response (AJ71E71 → Other station)

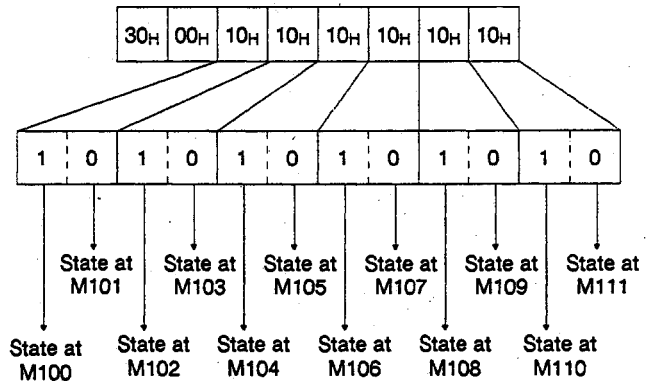

(2) Communications in ASCII code

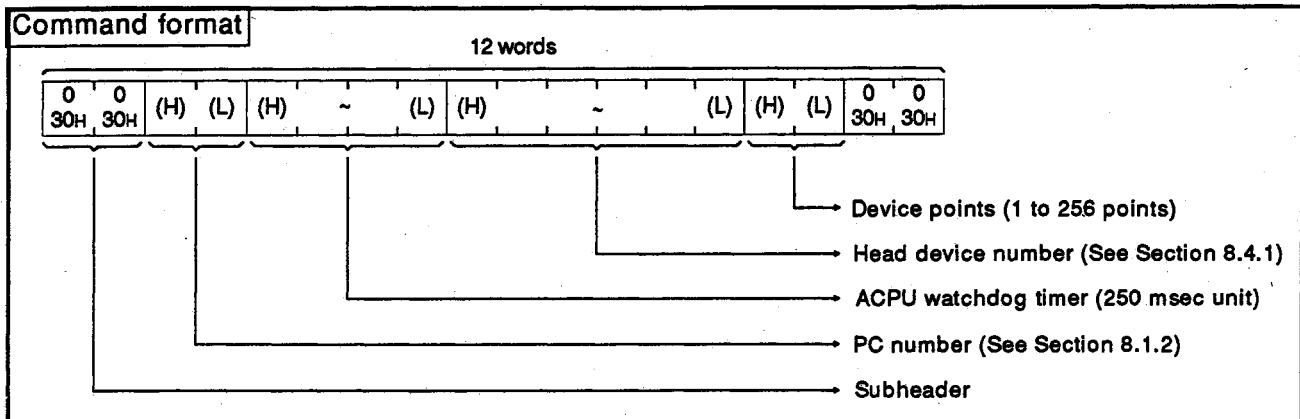

REMARKS

- (1) When device points is specified to 256 points, set "3030H".
- (2) If the number of device points specified is an odd number, 1 byte of dummy data (30H) will be added to the response data. For example, if three points are read, data equivalent to 4 points will be returned. The final byte of this data will be dummy data.

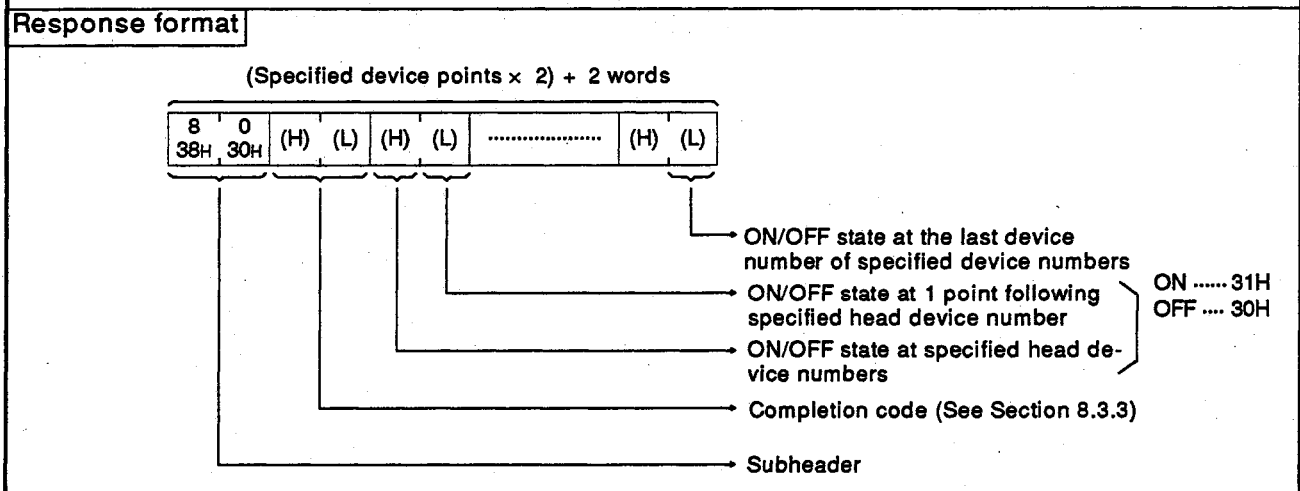

Example: When reading the ON/OFF state of M100 to M111 of a PC CPU loaded with AJ71E71

Command (Other station → AJ71E71)

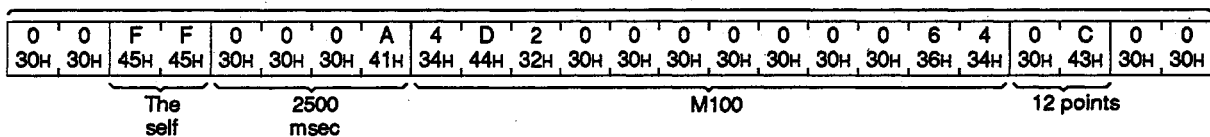

Response (AJ71E71 → Other station)

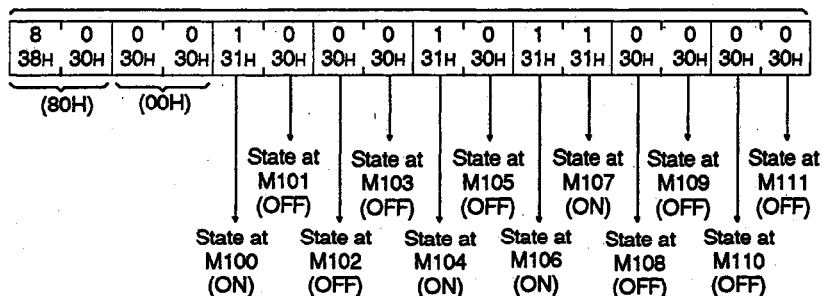

8. READING AND WRITING DATA STORED IN THE PC CPU MELSEC-A

8.4.3 Batch read in word unit

When batch read of word device memory and batch read of bit device memory (16 points unit) is done, the command and response format are as follows:

(1) Communications in binary code

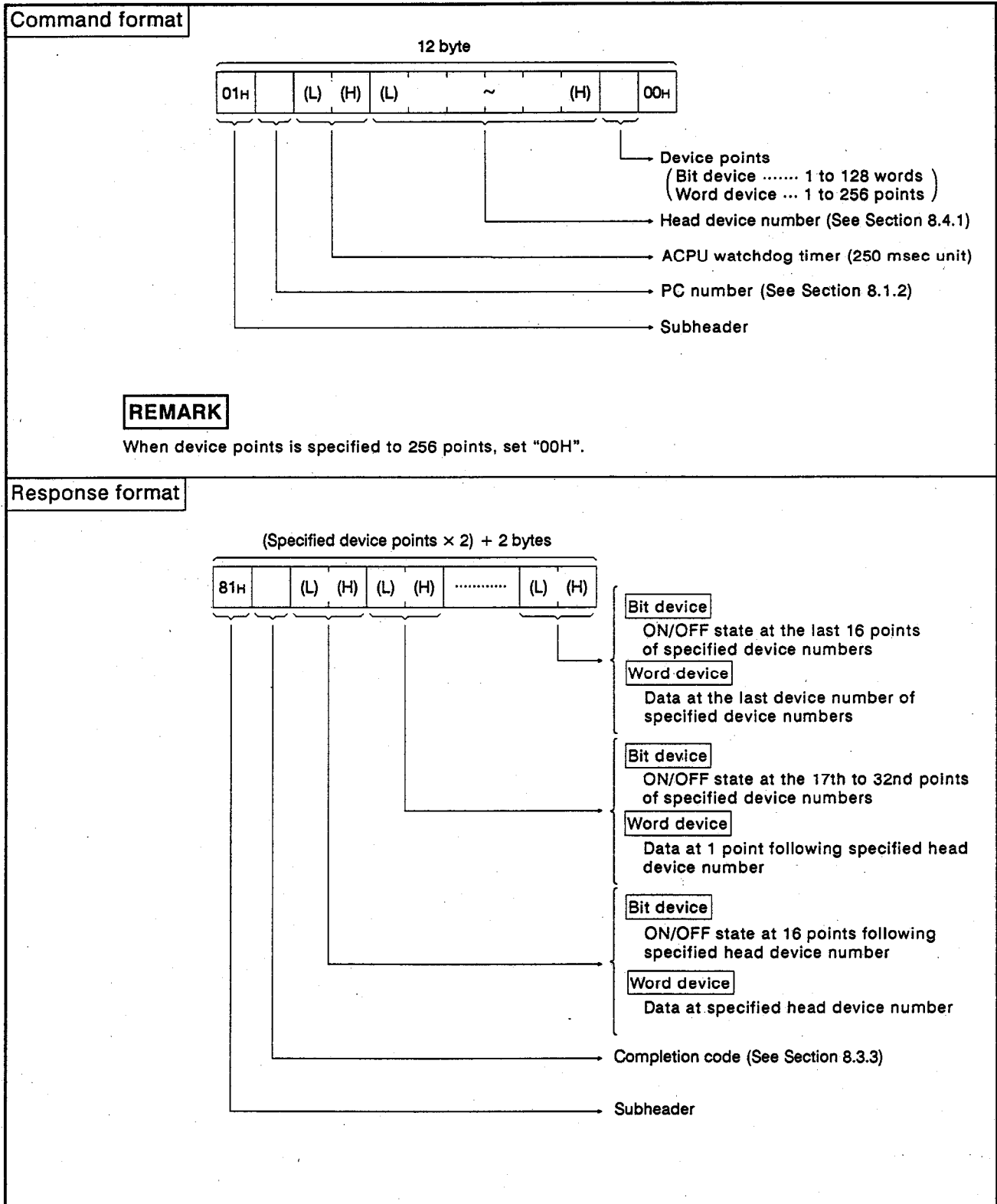

8. READING AND WRITING DATA STORED IN THE PC CPU MELSEC-A

Example 1: When reading the ON/OFF state of Y40 to 5F (32 points) of a PC CPU loaded with AJ71E71

Command (Other node → AJ71E71)

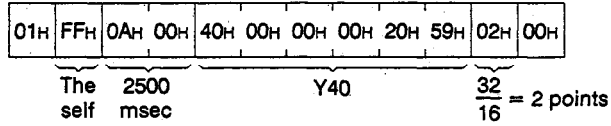

Response (AJ71E71 → Other node)

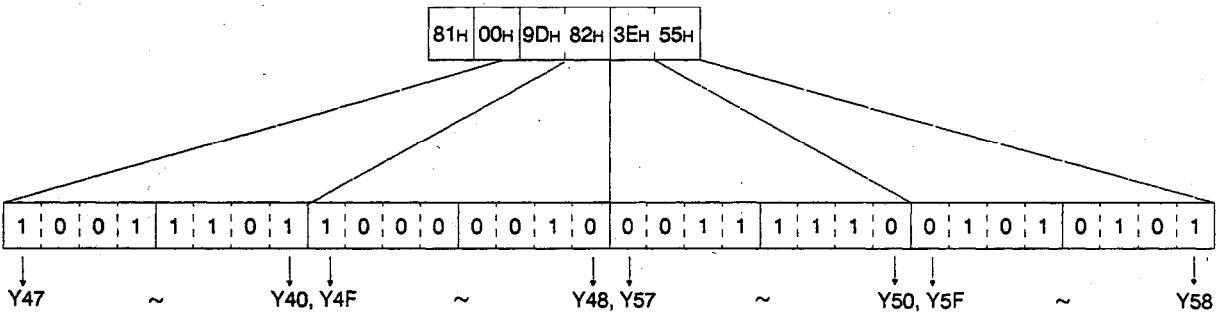

Example 2: When reading the data of D80 to D83 of a PC CPU loaded with AJ71E71

Command (Other node → AJ71E71)

Response (AJ71E71 → Other node)

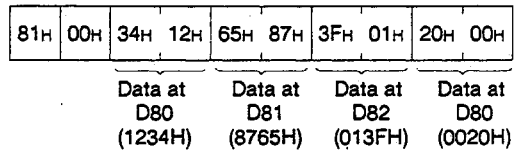
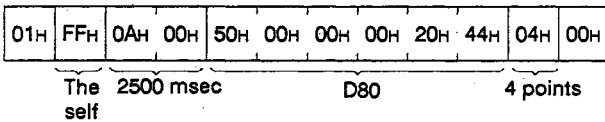

8. READING AND WRITING DATA STORED IN THE PC CPU

MELSEC-A

(2) Communications in ASCII code

Command format

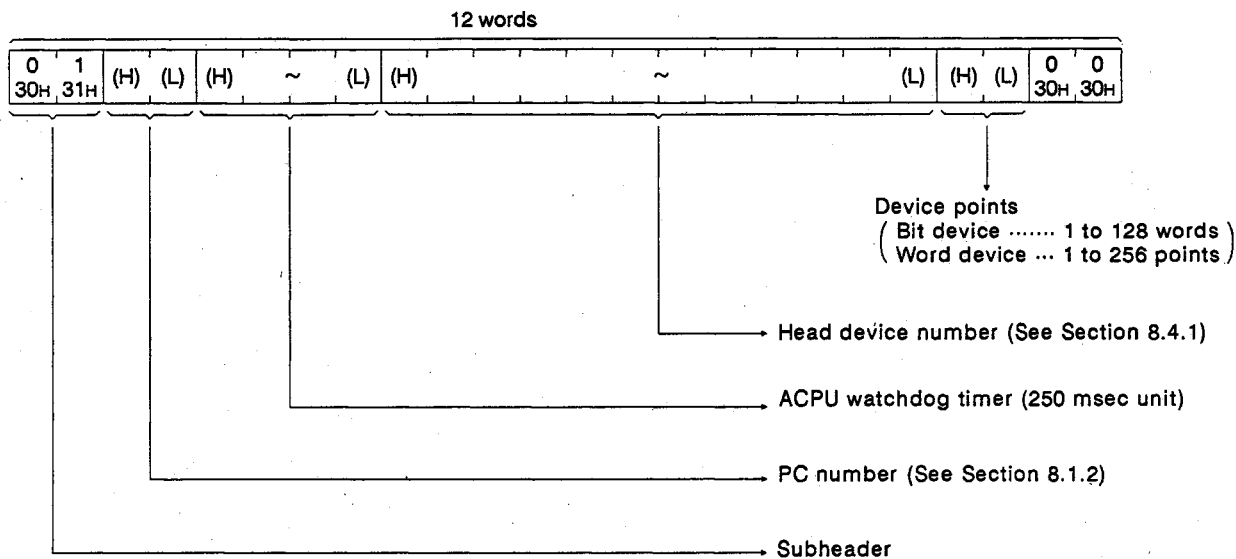

REMARK

When device points is specified to 256 points, set "3030H".

Response format

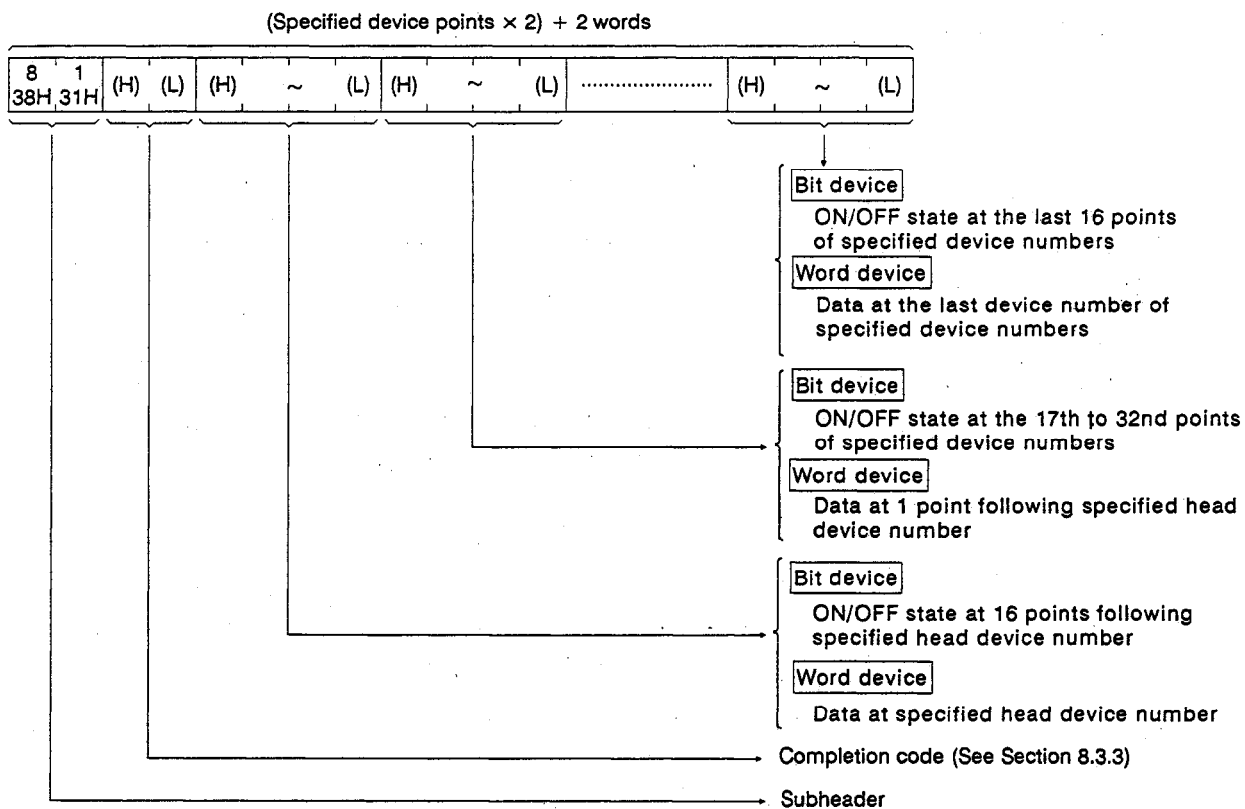

8. READING AND WRITING DATA STORED IN THE PC CPU MELSEC-A

Example 1: When reading the ON/OFF state of Y40 to 5F (32 points) of a PC CPU loaded with AJ71E71

Command (Other node → AJ71E71)

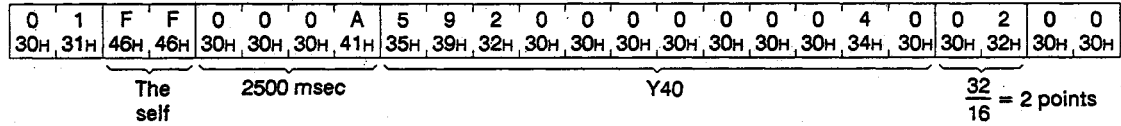

Response (AJ71E71 → Other node)

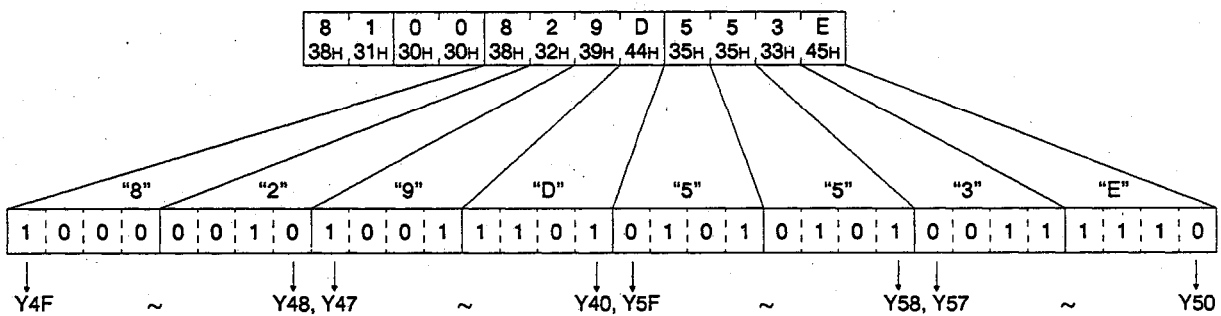

Example 2: When reading the data of D80 to D82 of a PC CPU loaded with AJ71E71

Command (Other node → AJ71E71)

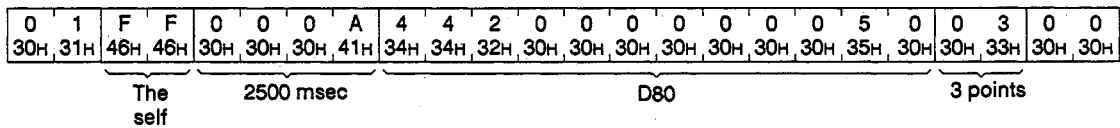

Response (AJ71E71 → Other node)

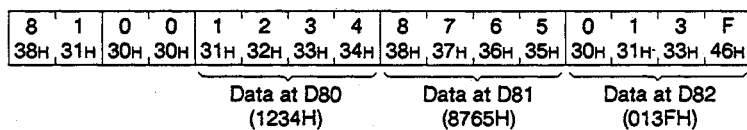

8. READING AND WRITING DATA STORED IN THE PC CPU MELSEC-A

8.4.4 Batch write in bit units

When batch write of bit device memory is done, the command and response format are as follows:

(1) Communications in binary code

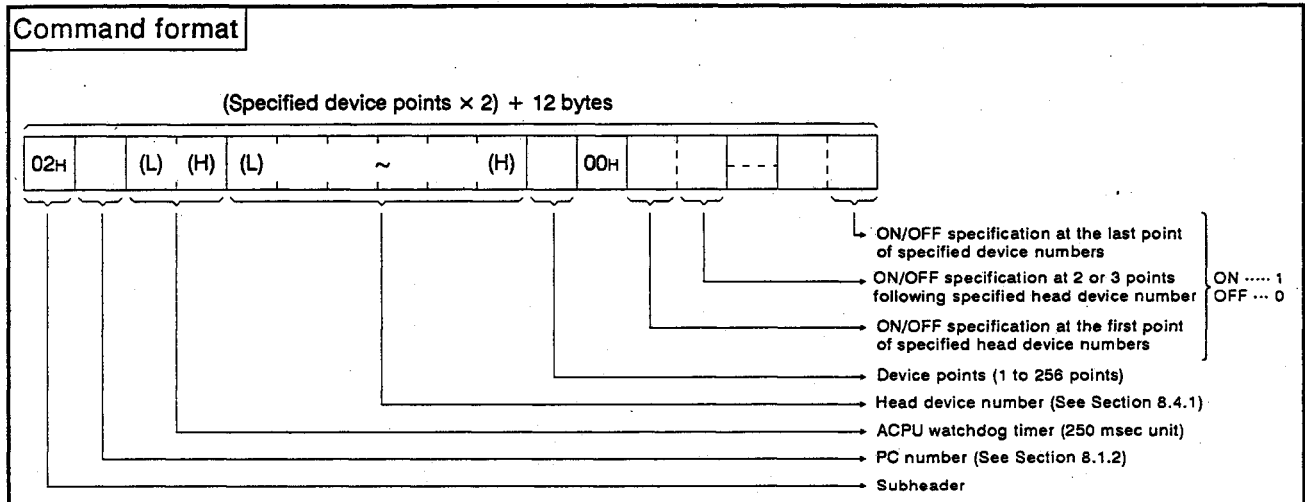

REMARK

When device points is specified to 256 points, set "00H".

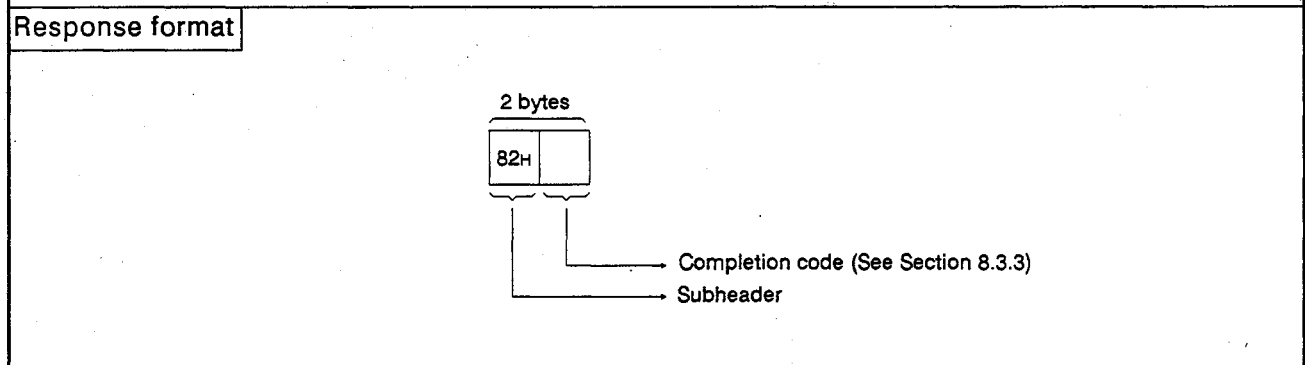

Example: When writing the ON/OFF data to M50 to M61 of a PC CPU loaded with AJ71E71

Command (Other node → AJ71E71)

Response (AJ71E71 → Other node)

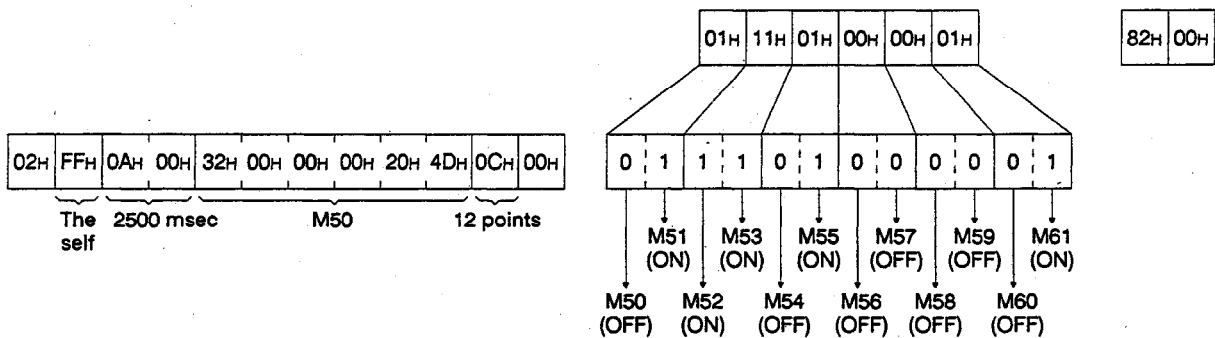

8. READING AND WRITING DATA STORED IN THE PC CPU MELSEC-A

(2) Communications in ASCII code

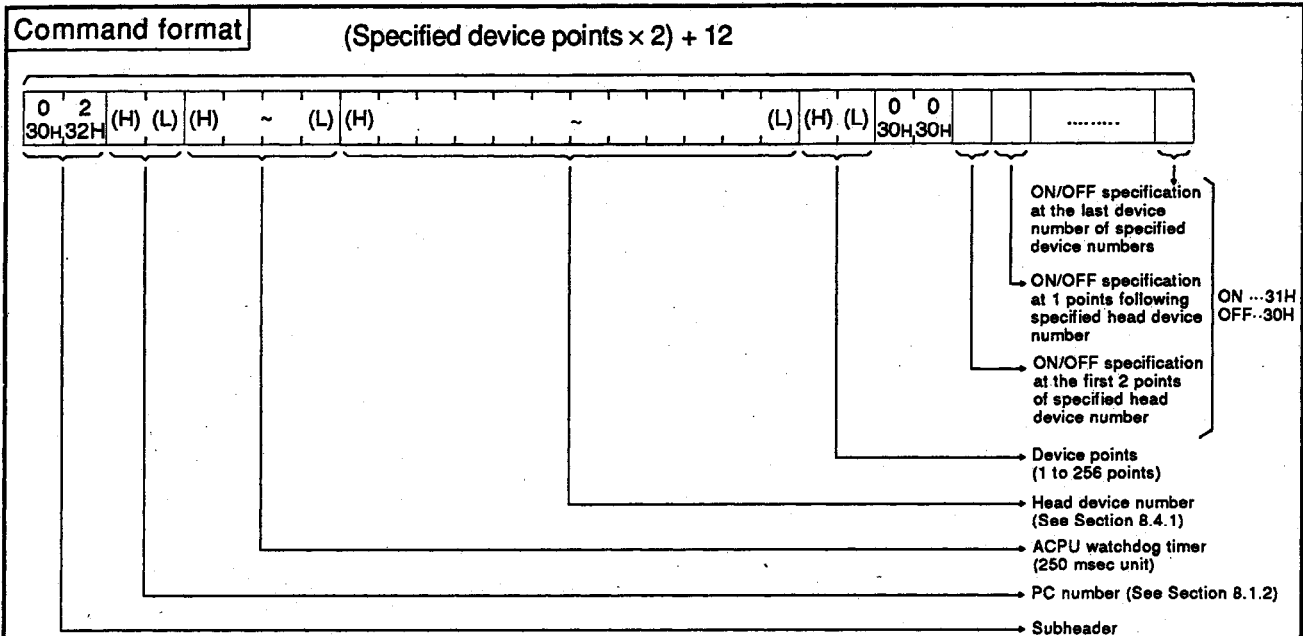

REMARKS

- (1) When device points is specified to 256 points, set "3030H".
- (2) If the number of device points specified is an odd number, 1 byte of dummy data (30H) will be added as the last byte of the write data. For example, if three points are written, one byte of dummy data (30H) will be added.

Response format

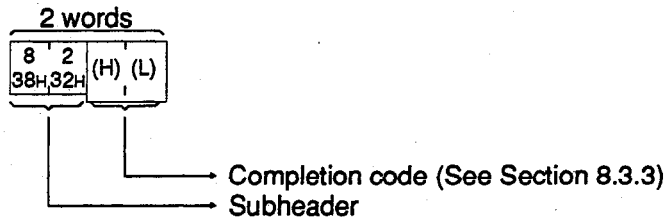

Example: When writing the ON/OFF data to M50 to M61 of a PC CPU loaded with AJ71E71

Command (Other node → AJ71E71)

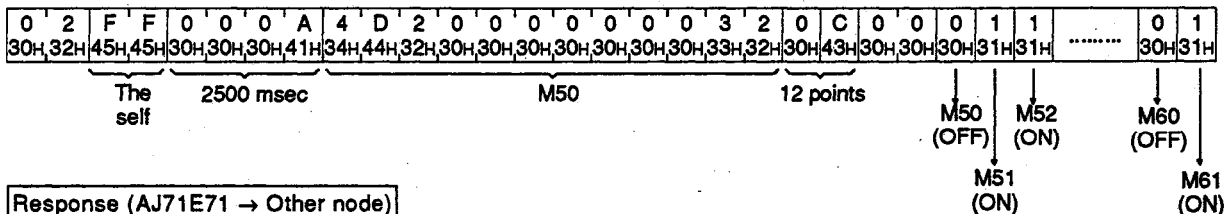

Response (AJ71E71 → Other node)

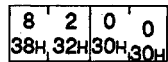

8. READING AND WRITING DATA STORED IN THE PC CPU MELSEC-A

8.4.5 Batch write in word units

The command and response formats are as follows when batch write of word device memory and batch write of bit device memory (16 points unit) is done:

(1) Communications in binary code

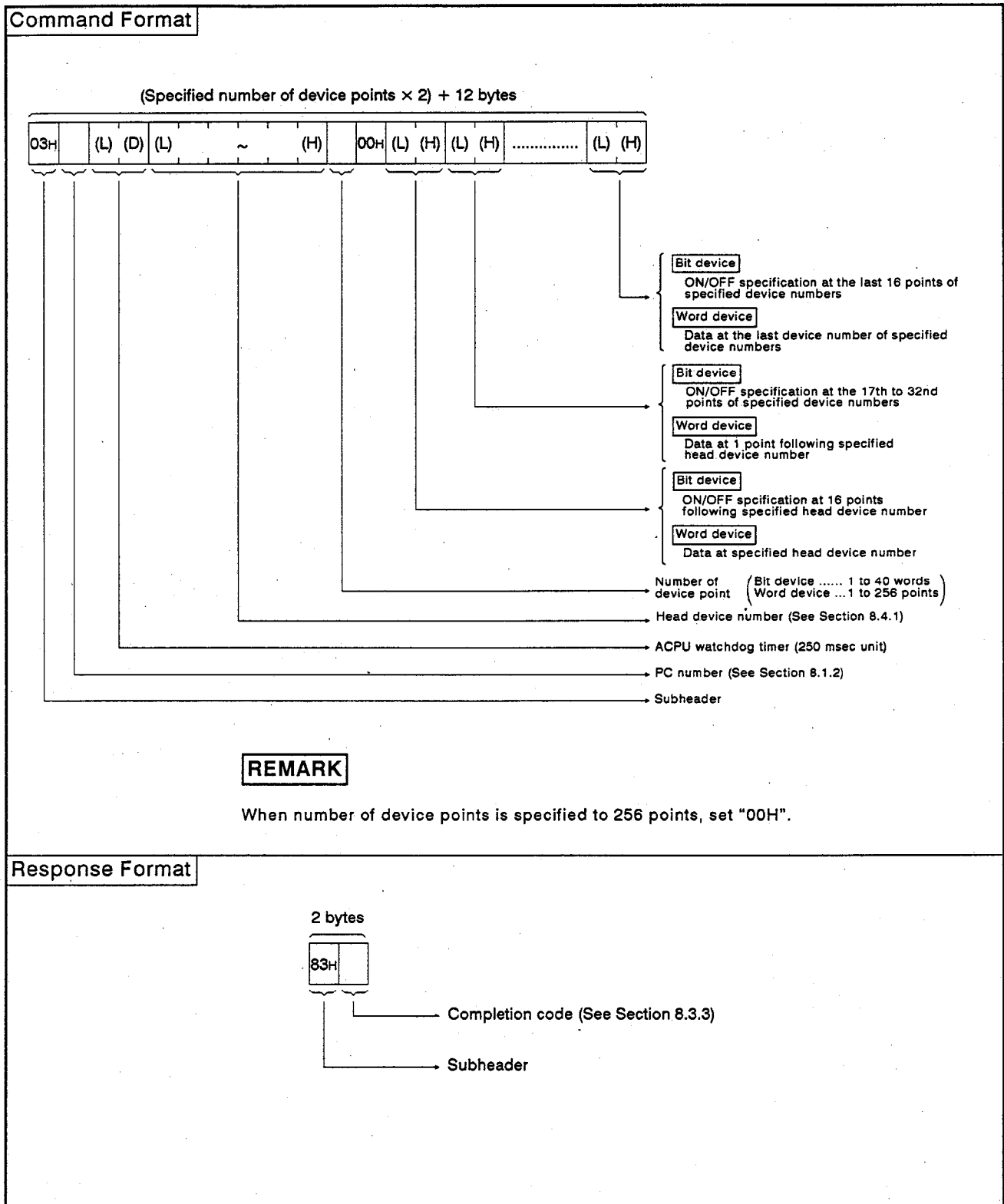

8. READING AND WRITING DATA STORED IN THE PC CPU MELSEC-A

Example 1: When writing the ON/OFF data to X60 to 7F (32 points) of a PC CPU loaded with AJ71E71

Command (Other station → AJ71E71)

Response (AJ71E71 → Other station)

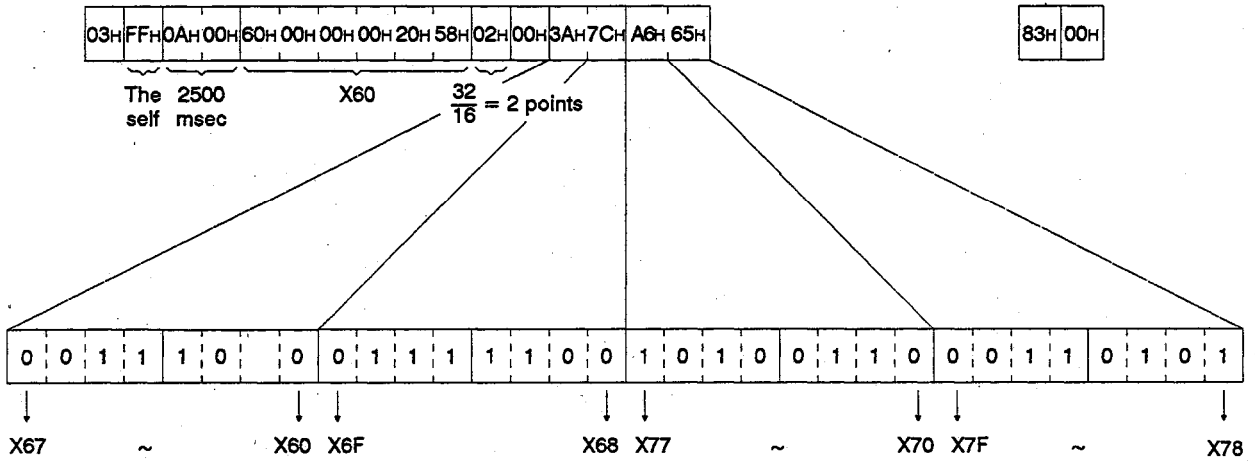

Example 2: When writing data to D100 to D102 of a PC CPU loaded with AJ71E71

Command (Other station → AJ71E71)

Response (AJ71E71 → Other station)

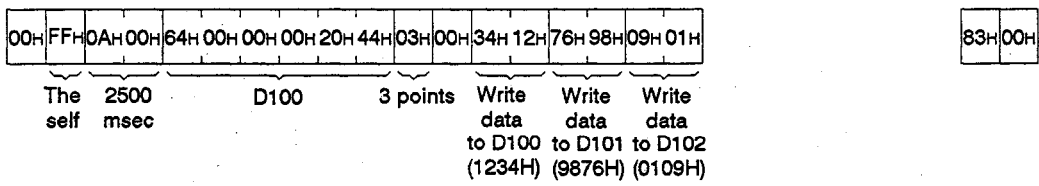

(2) Communications in ASCII code

Command Format

(Specified number of device points × 2) + 12 words

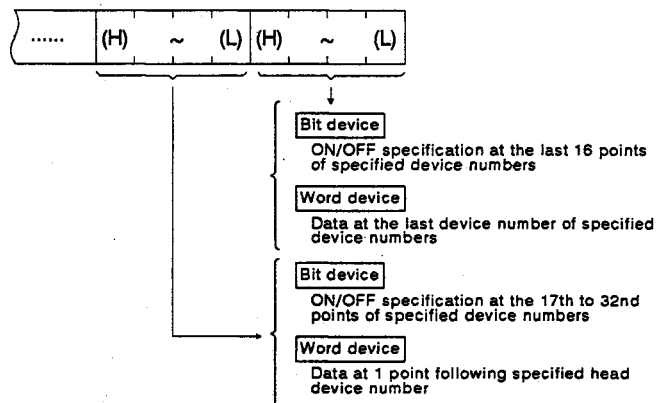
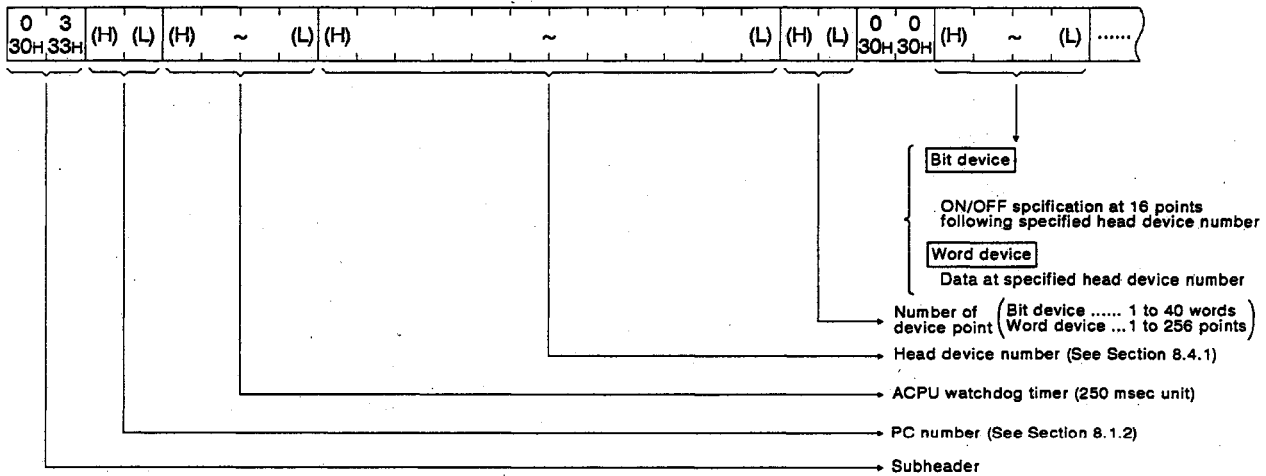

REMARK

When number of device points is specified to 256 points, set "3030H".

Response Format

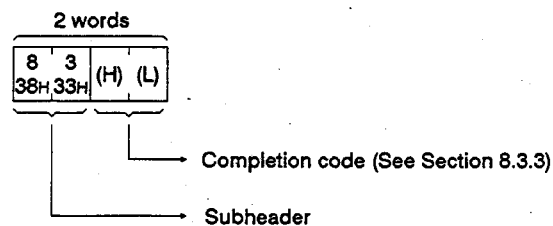

8. READING AND WRITING DATA STORED IN THE PC CPU

MELSEC-A

8.4.6 Test (random write) in bit units

The command and response formats are as follows when bit device memory is specified at random and is written:

(1) Communications in binary code

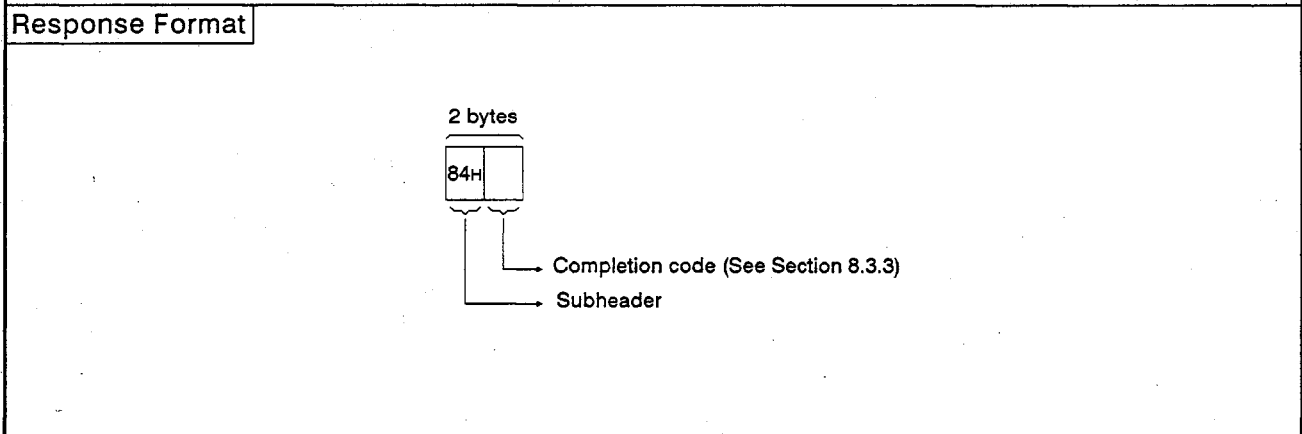
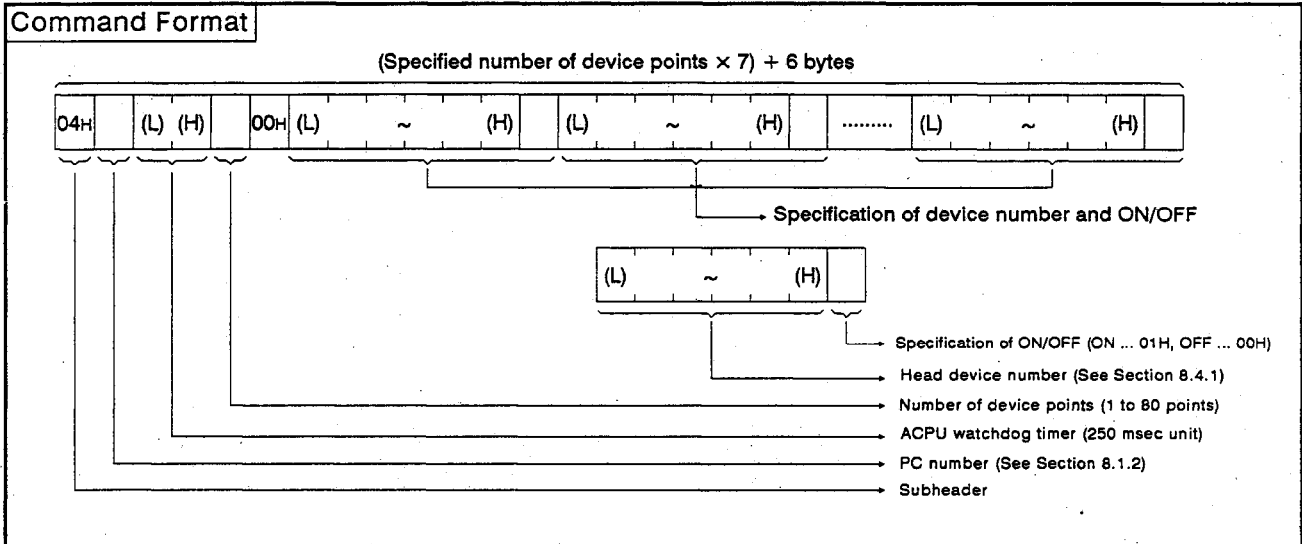

Example: When turning ON X94 and B26 and turning OFF M60 of a PC CPU loaded with AJ71E71

Command (Other station → AJ71E71)

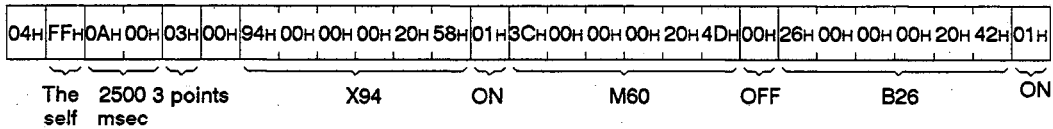

Response (AJ71E71 → Other station)



8. READING AND WRITING DATA STORED IN THE PC CPU MELSEC-A

(2) Communications in ASCII code

Command Format

(Specified number of device points × 7) + 6 words

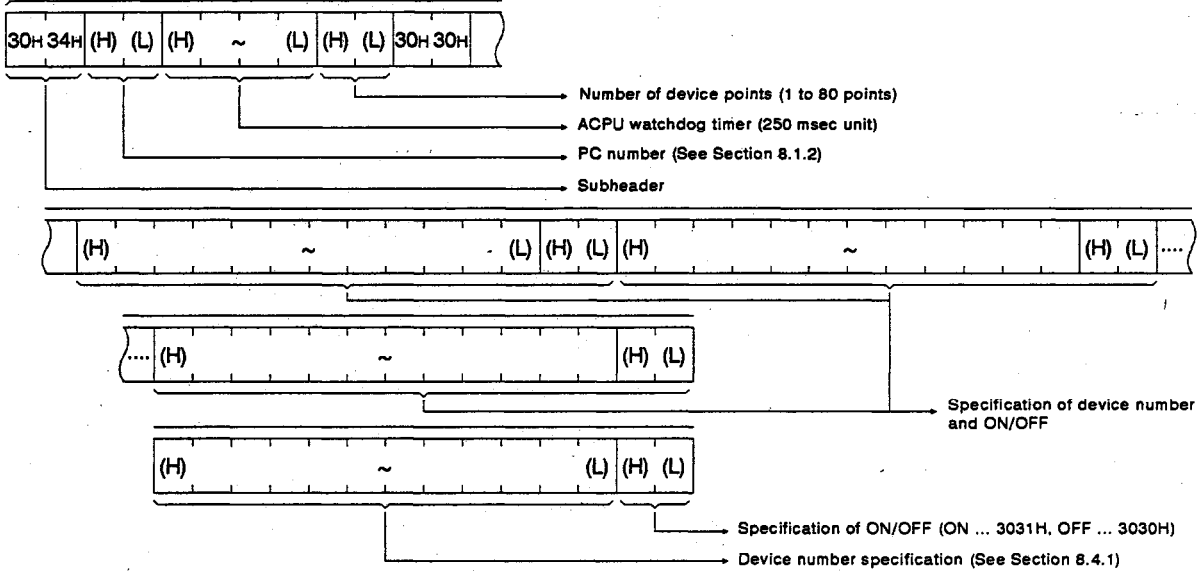

Response Format

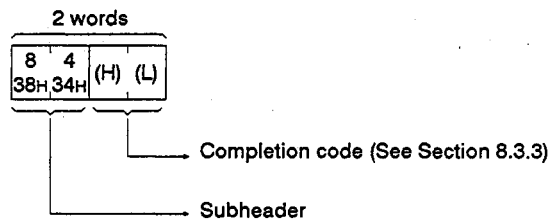

Example: When turning ON X94 and B26 and tuning OFF M60 of a PC CPU loaded with AJ71E71

Command (Other station → AJ71E71)

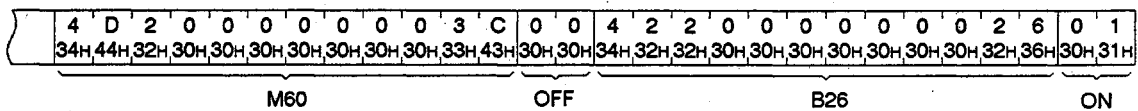
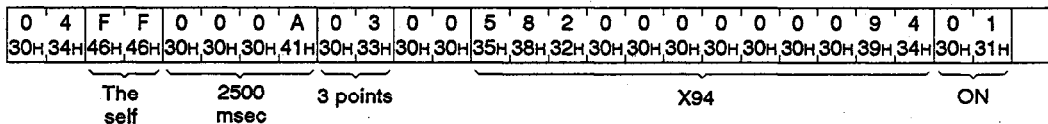

Response (AJ71E71 → Other station)

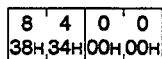

8. READING AND WRITING DATA STORED IN THE PC CPU

MELSEC-A

8.4.7 Test (random write) in word unit

The command and response formats are as follows when word device memory and bit device memory (16 points unit) is specified at random and is written:

(1) Communications in binary code

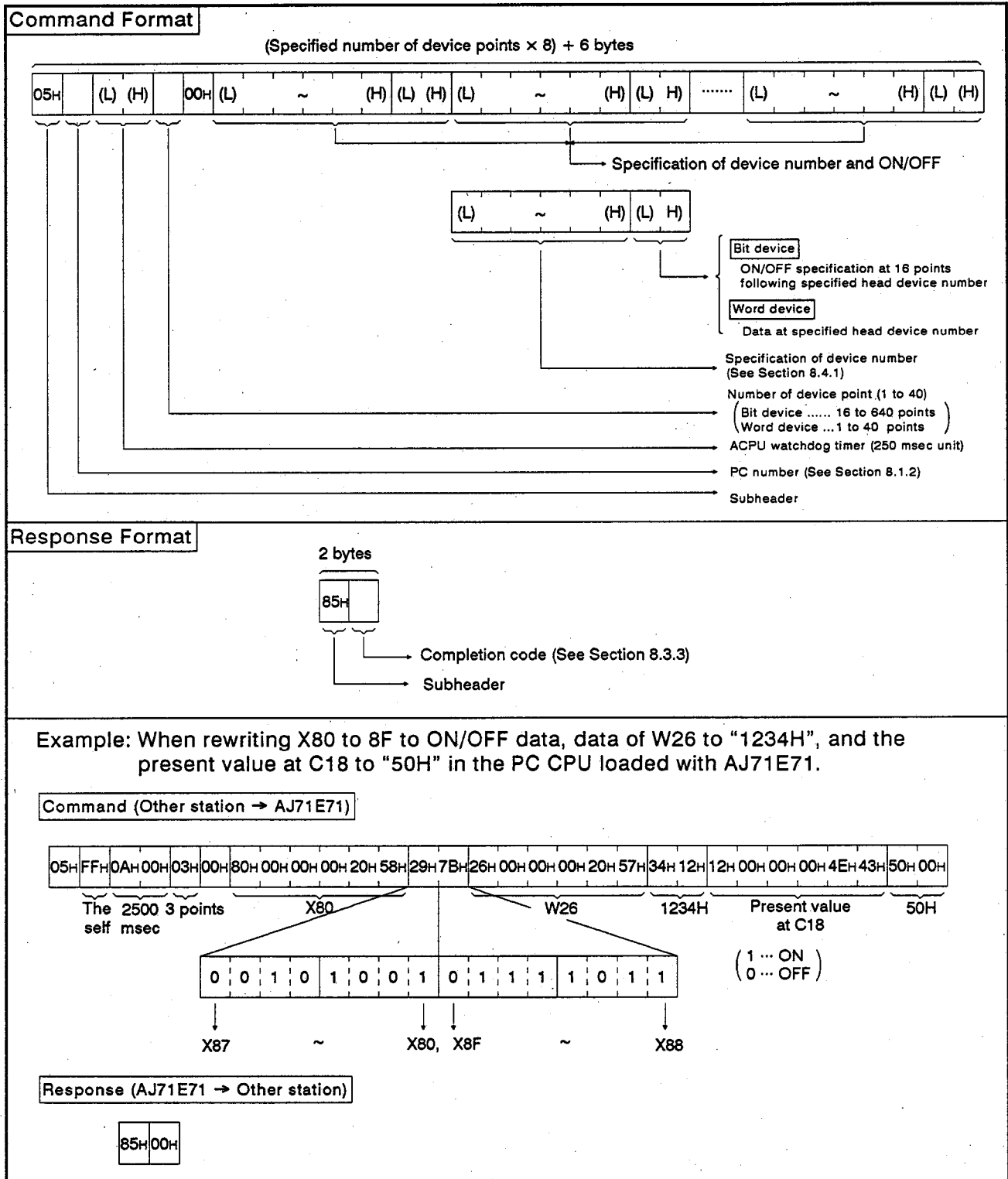

8. READING AND WRITING DATA STORED IN THE PC CPU

MELSEC-A

(2) Communications in ASCII code

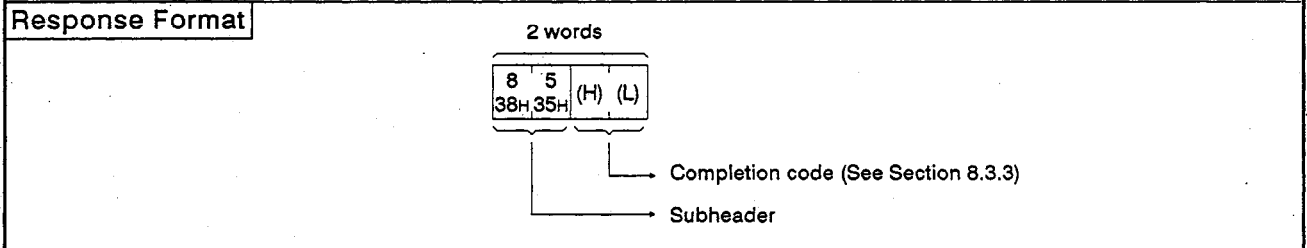
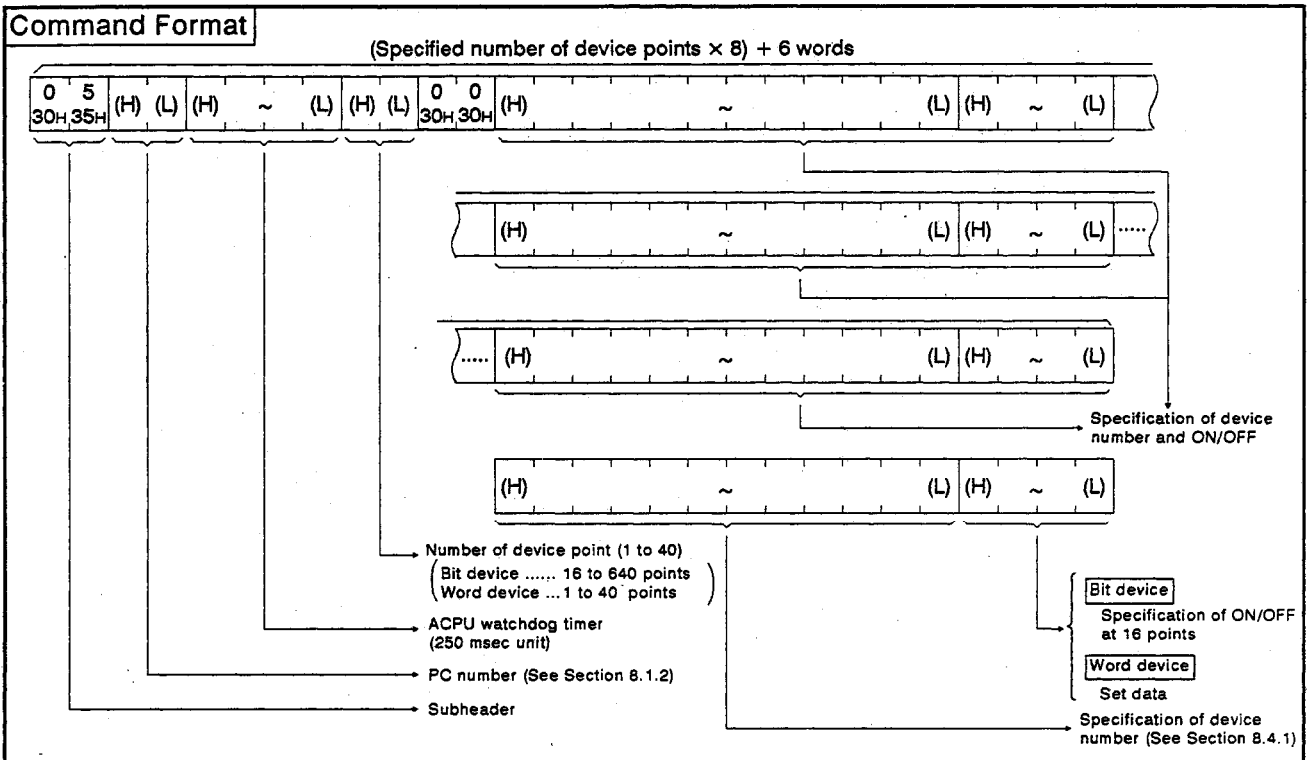

Example: When rewriting X80 to 8F to ON/OFF data, data of W26 to "1234H", and the present value of C18 to "50H" in the PC CPU loaded with AJ71E71.

Command (Other station → AJ71E71)

Response (AJ71E71 → Other station)

0 5 F F 0 0 0 A 0 3 0 0
30H 35H 46H 46H 30H 30H 30H 41H 30H 33H 30H 30H

8 5 0 0
38H 35H 30H 30H

The self 2500 msec 3 points

5 8 2 0 0 0 0 0 0 0 8 0 7 B 2 9 5 7 2 0 0 0 0 0 0 0 0 2 6
35H 38H 32H 30H 30H 30H 30H 30H 30H 30H 38H 30H 37H 42H 32H 39H 35H 37H 32H 30H 30H 30H 30H 30H 30H 30H 32H 36H

X80 W26

0 1 1 1 1 0 1 1 0 0 1 0 1 0 0 1

X8F ~ X88 X87 ~ X80

1 2 3 4 4 3 4 E 0 0 0 0 0 0 0 1 2 0 0 5 0
31H 32H 33H 34H 34H 33H 34H 45H 30H 30H 30H 30H 30H 30H 30H 31H 32H 30H 30H 35H 30H

1234H Present value at C18 50H

8. READING AND WRITING DATA STORED IN THE PC CPU MELSEC-A

8.4.8 Monitoring device memory

The ON/OFF state or data of a device in the PC CPU can be monitored by a communicating station by transmitting a monitoring command from the communicating station.

The type and the number of a device to be monitored must be registered in advance to AJ71E71.

When device memory is read by using batch read processing, the devices are read by serial device numbers.

The type and the number of a device can be specified at random in case of the read by the monitoring function.

(1) Procedure for monitoring

The chart below shows the operation procedure to execute monitoring.

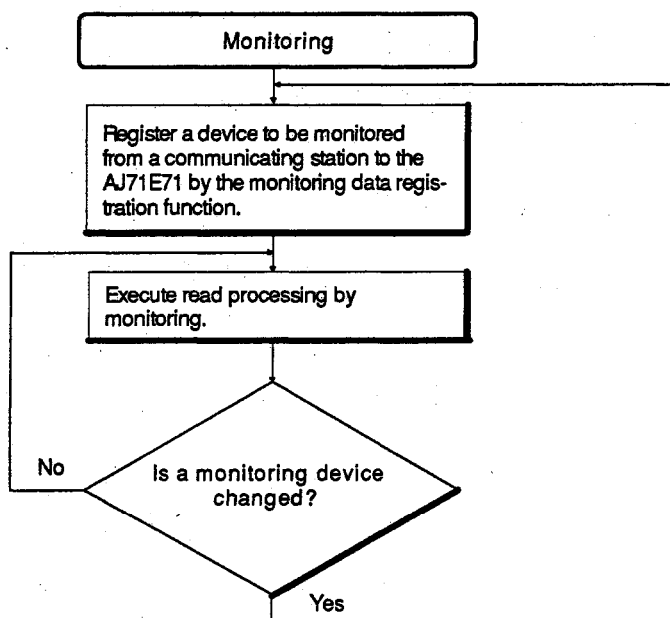

POINTS

- (1) Be sure to execute monitoring after doing monitoring data registration according to the above-mentioned operation procedure.

When monitoring is executed without doing monitoring data registration, an error (completion code 57H) occurs.

- (2) When a power supply is turned OFF, and the PC CPU is reset, the contents of monitoring data registration are cleared.
- (3) The bit unit and the word unit of a device memory and the extension file register can be registered in case of monitoring data registration.

(2) Monitoring data registration

The command and the response formats are as follows when a monitoring device is registered:

(a) Communications in binary code

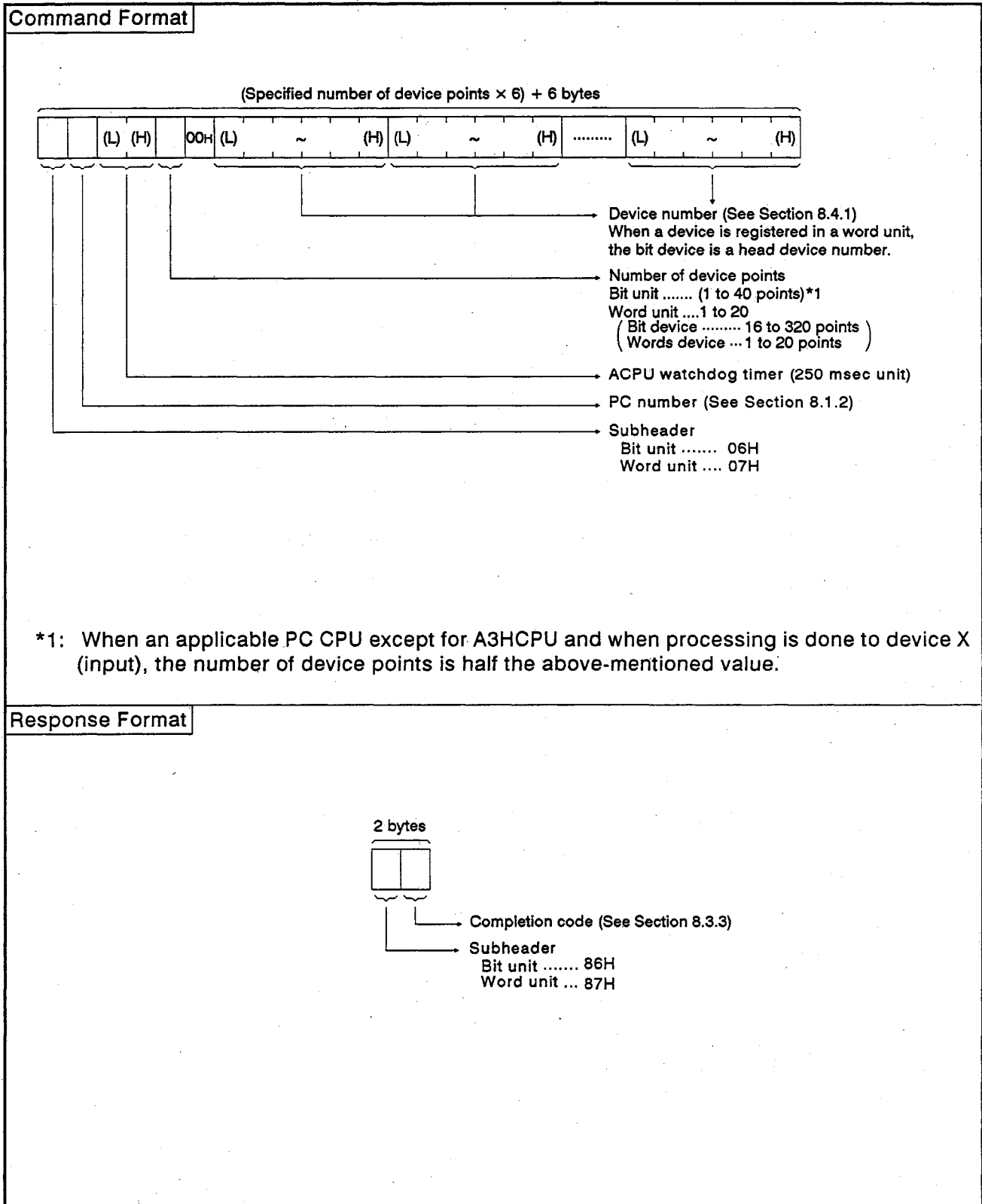

8. READING AND WRITING DATA STORED IN THE PC CPU MELSEC-A

Example 1: Monitoring data registration in bit units
 When setting Y46, M12 and B2C of a PC CPU loaded with AJ71E71

Command (Other station → AJ71E71)

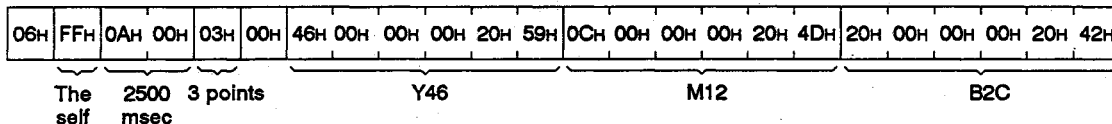

Response (AJ71E71 → Other station)



Example 2: Monitoring data registration in bit units
 When setting Y50 to 5F, D38 and W1E of a PC CPU loaded with AJ71E71

Command (Other station → AJ71E71)

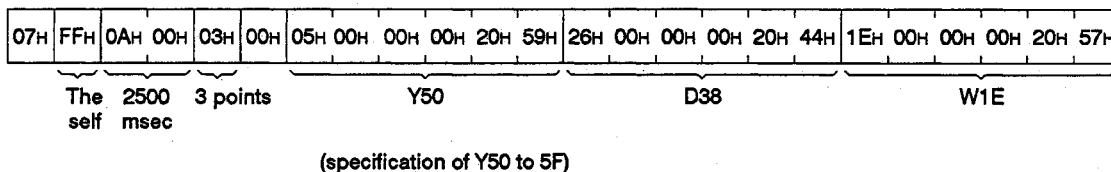

Response (AJ71E71 → Other station)



(b) Communications in ASCII code

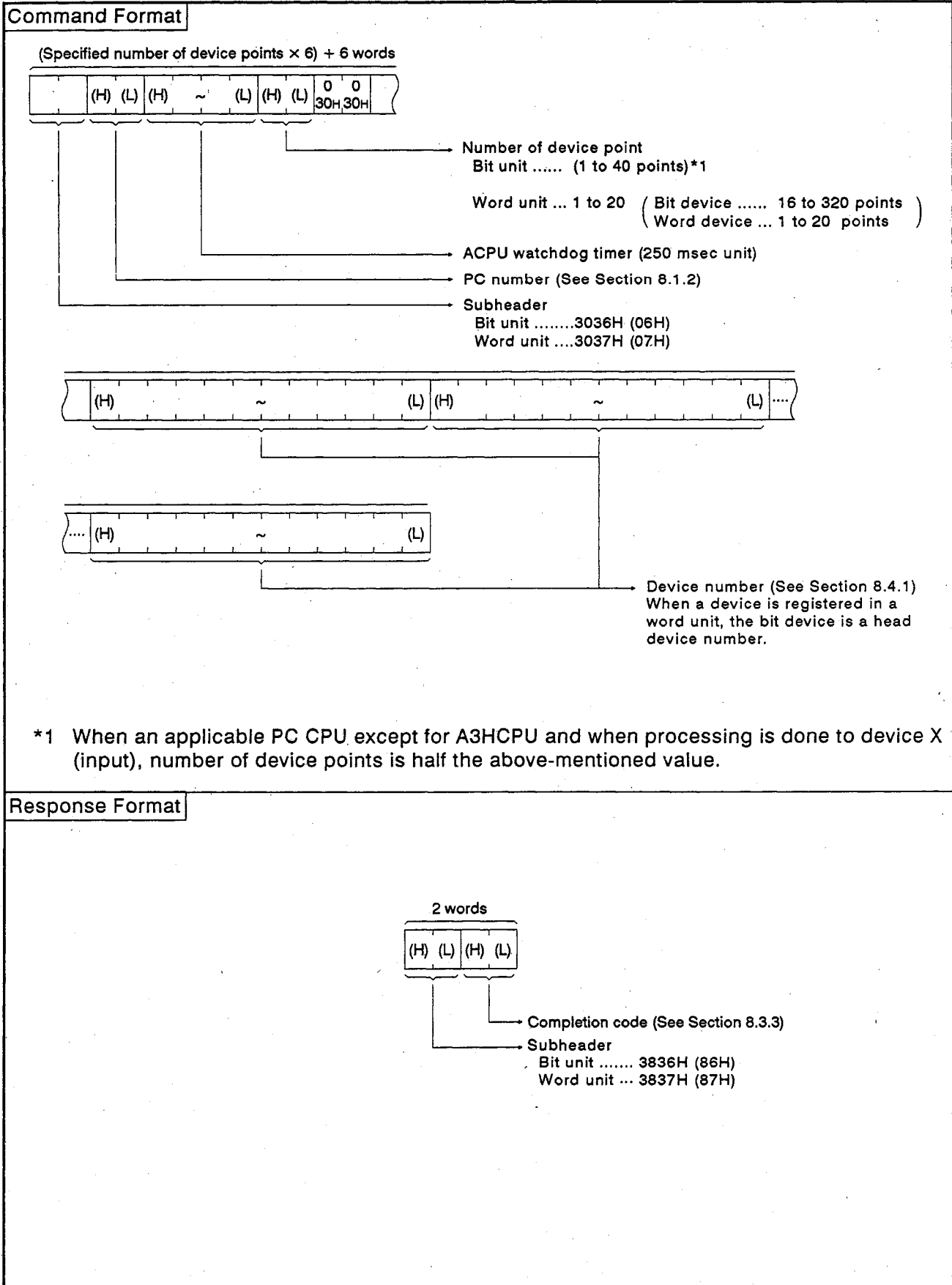

8. READING AND WRITING DATA STORED IN THE PC CPU

MELSEC-A

Example 1: Monitoring data registration in bit units

When setting Y46, M12 and B2C of a PC CPU loaded with AJ71E71

Command (Other station → AJ71E71)

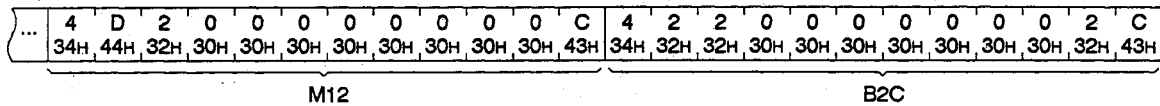
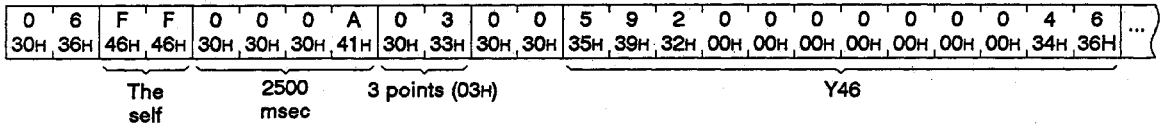

Response (AJ71E71 → Other station)

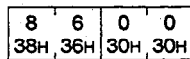

Example 2: Monitoring data registration in bit units

When setting Y50, D38 and W1E of a PC CPU loaded with AJ71E71

Command (Other station → AJ71E71)

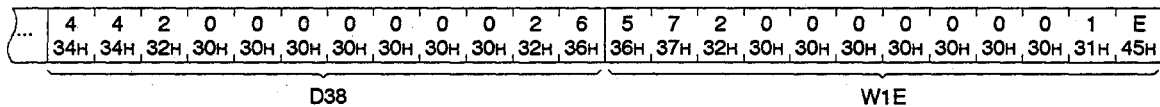
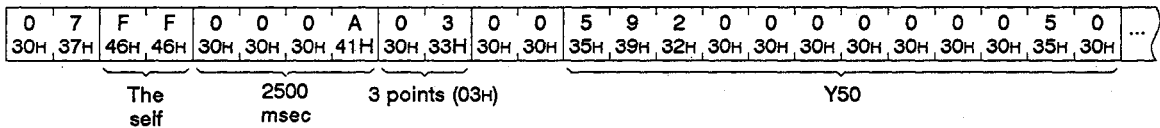

Response (AJ71E71 → Other station)

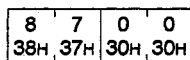

8. READING AND WRITING DATA STORED IN THE PC CPU MELSEC-A

(3) Monitoring in bit units

The command and response formats are as follows when a bit device set by monitoring data registration is monitored:

(a) Communications in binary code

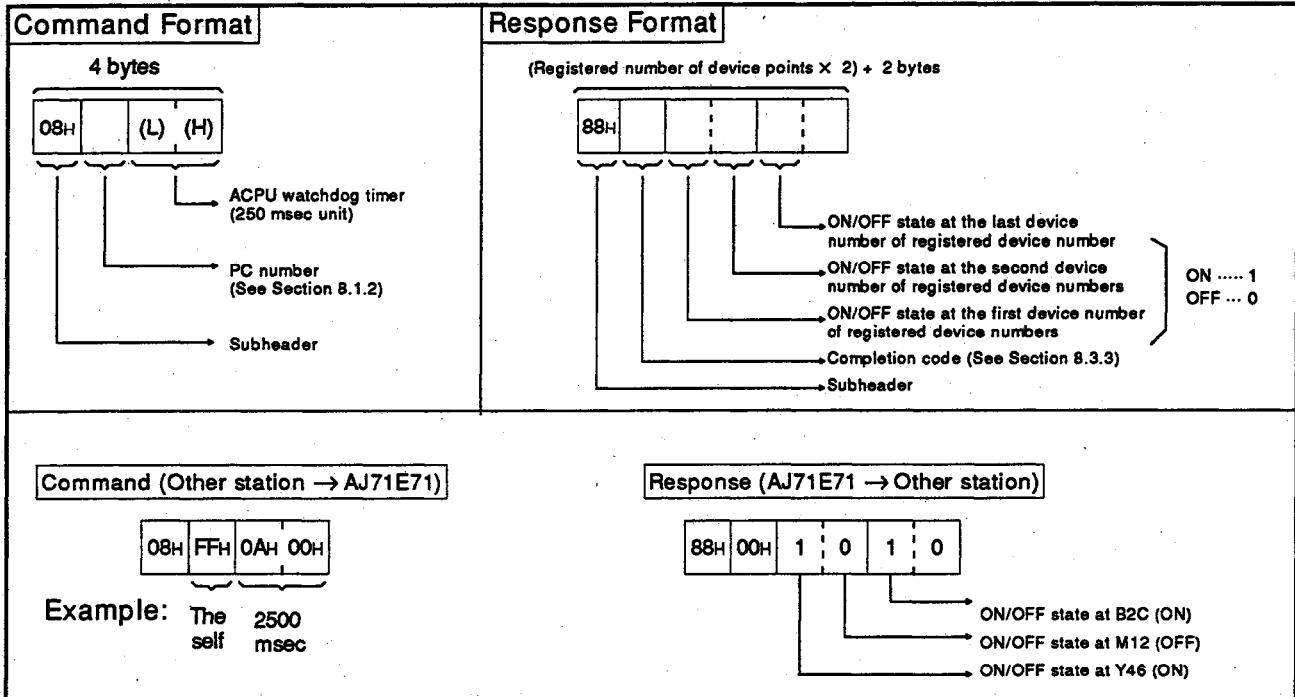

(b) Communications in ASCII code

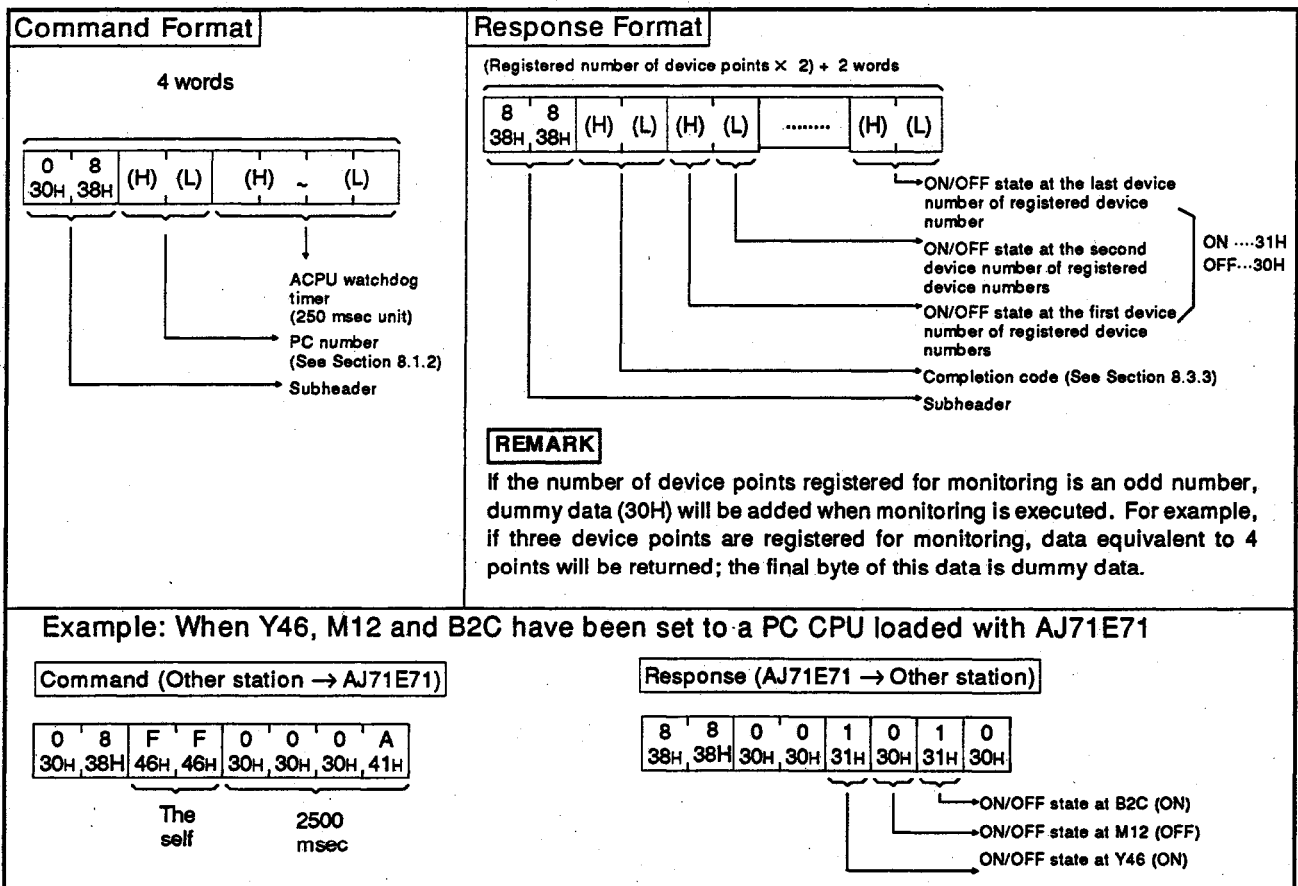

(4) Monitoring in word units

The command and response formats are as follows when a word device and a bit device (16 points unit) set by monitoring data registration are monitored:

(a) Communications in binary code

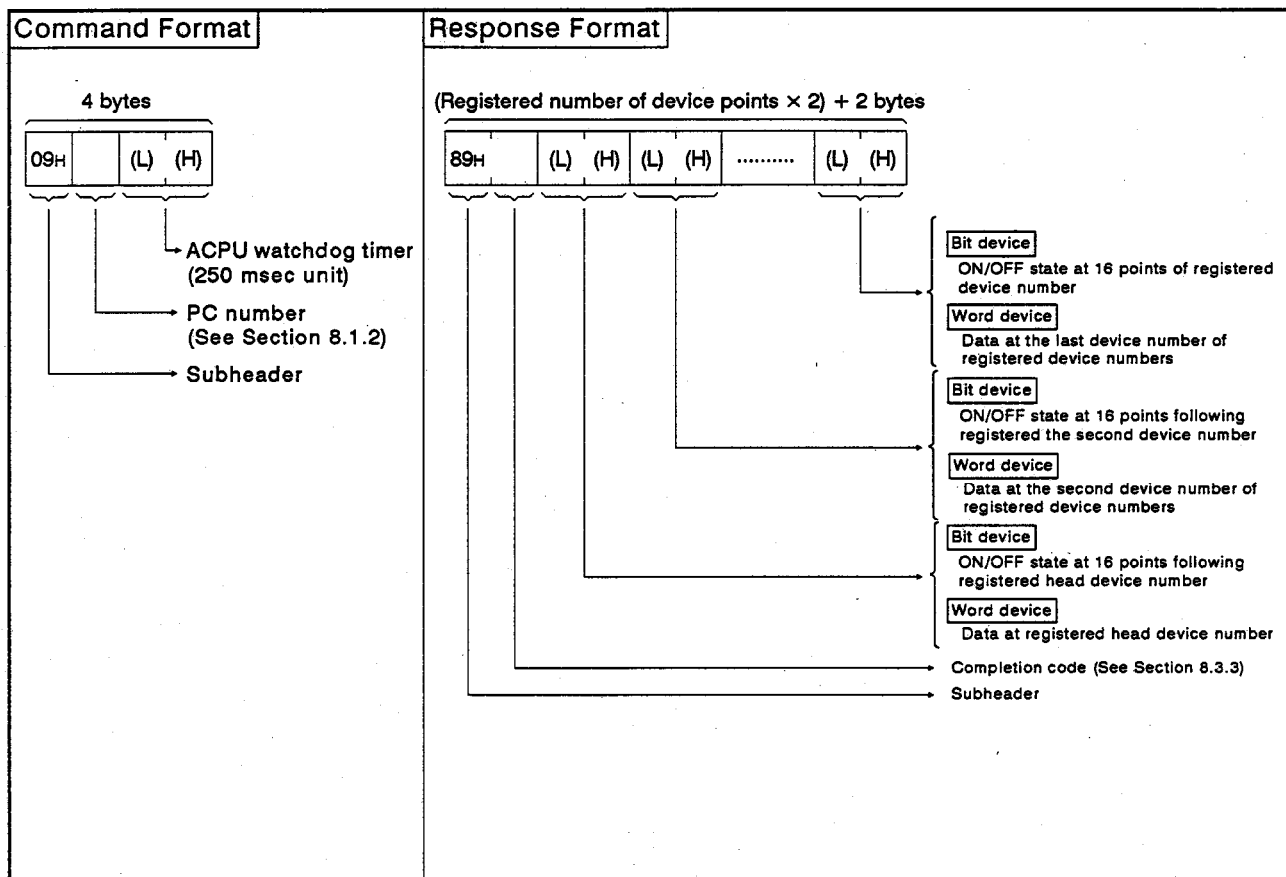

Example: When Y50 to 5F, D38 and W1E have been set to a PC CPU loaded with AJ71E71

Command (Other station → AJ71E71)

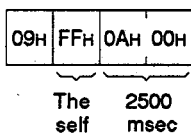

Response (AJ71E71 → Other station)

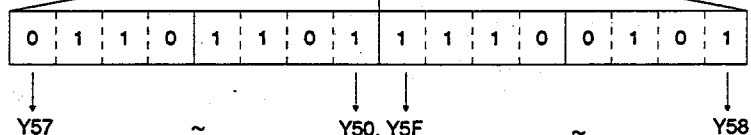
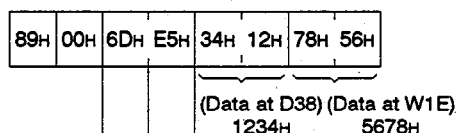

8. READING AND WRITING DATA STORED IN THE PC CPU

MELSEC-A

(b) Communications in ASCII code

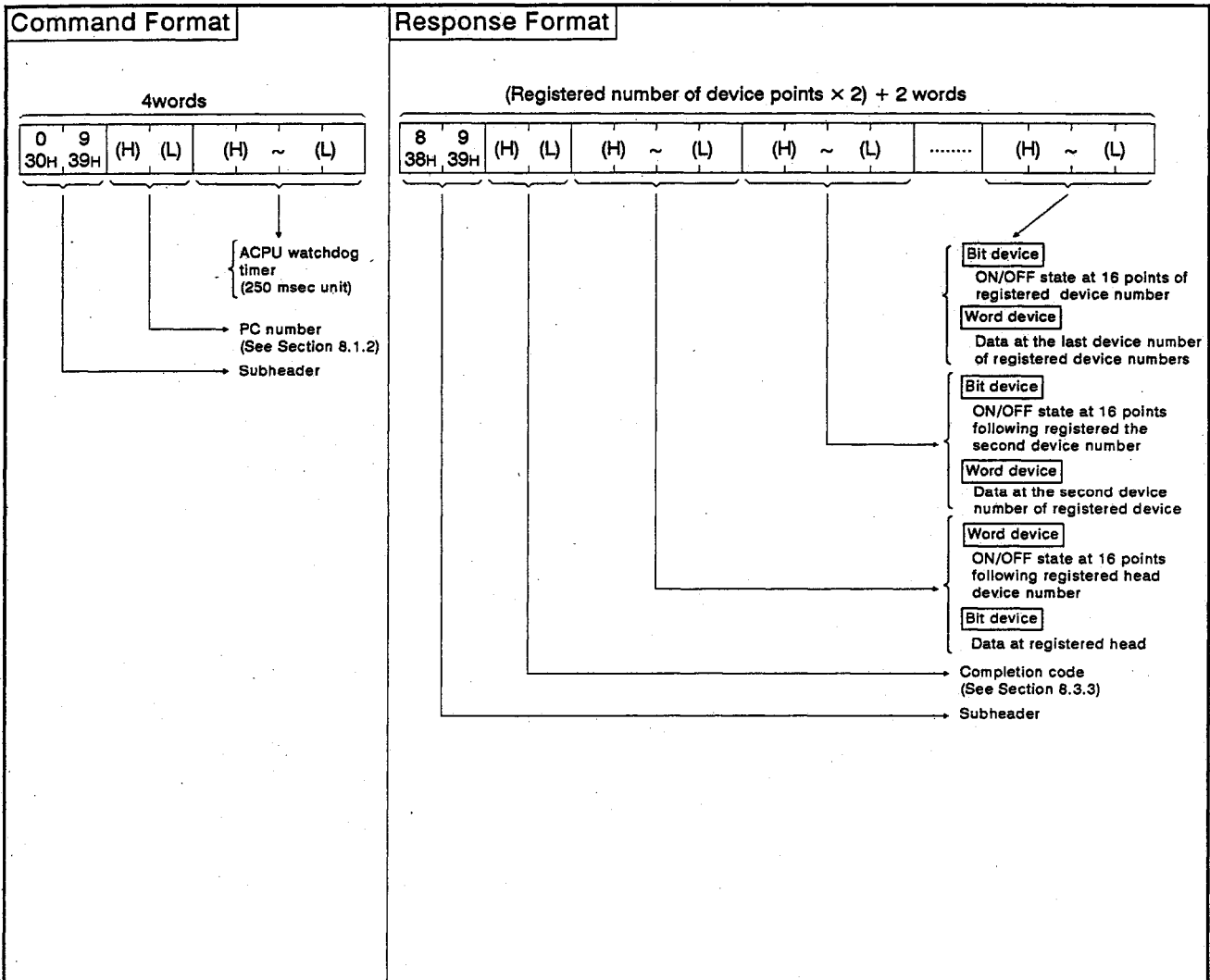

Example: When Y50 to 5F, D38 and W1E have been set to a PC CPU loaded with AJ71E71

Command (Other station → AJ71E71)

Response (AJ71E71 → Other station)

0	9	F	F	0	0	0	A
30H	39H	46H	46H	30H	30H	30H	41H

The self 2500 msec

8	9	0	0	E	5	6	D	1	2	3	4	5	6	7	8
38H	39H	30H	30H	45H	35H	36H	44H	31H	32H	33H	44H	35H	36H	37H	38H

(Data at D38) 1234H (Data at W1E) 5678H

1	1	1	0	0	1	0	1	0	1	1	0	1	1	0	1
---	---	---	---	---	---	---	---	---	---	---	---	---	---	---	---

Y5F ~ Y58, Y57 ~ Y50

8. READING AND WRITING DATA STORED IN THE PC CPU

MELSEC-A

8.5. Command and Response Formats for Read/Write of Extension File Register

An extension file register uses an empty area as a file register in the user memory area of a PC CPU.

Necessary data and operation results are stored in this area in case of various data processing done by using software package "SW[]GHP-UTLPC-FN1 utility package" (UTLP-FN1).

The following explains the contents, the method and the example of the control protocol to be used for read/write of extension file registers.

8.5.1 Commands and addresses

- (1) Table 8.6 shows the functions to be used for read/write of extension file registers.

Table 8.6 Function

Function	Command/ Response Classification	Description	Number of Point Processed per Communications	PC CPU State		
				During STOP	During RUN	
					SW22 ON	SW22 OFF
Batch read	17H	Reads extension file registers (R) in units of 1 register.	256 points	o	o	o
Batch write	18H	Writes extension file registers (R) in units of 1 register.	256 points	o	o	x
Test (random write)	19H	Specifies the extension file registers (R) in units of 1 register using block or device number and makes a random write.	40 points	o	o	x
Monitor data registration	1AH	Sets the extension file registers (R) device number and makes a random write.	20 points	o	o	o
Monitor	1BH	Monitors the extension file register after monitor data registration.	-	o	o	o

- (2) Addresses of extension file registers

- (a) Extension file registers have block Nos. 0 to 28.

Block No. 0 Registers of the number of points specified by the parameter of a PC CPU

Block Nos. 1 to 28 .. These are used in the extension file register area or unused area of the memory cassette of a PC CPU. Each block has 8192 points of registers.

- (b) The range of block numbers changes according to the type of memory cassette and parameter setting of a PC CPU.

As for the details, refer to the ULTP-FN1 Operating Manual.

8. READING AND WRITING DATA STORED IN THE PC CPU

MELSEC-A

8.5.2 Precautions for Read/Write of Extension File Registers

- (1) The following explains precautions for read/write of extension file registers.
- (2) The extension file register cannot be used with A1 and A1N CPU.

Even when a block No. that does not exist is specified for read/write processing, a certain type of memory cassette installed to the PC CPU cannot sometimes detect an error (completion code 58H). Data read at this time is not correct data. And, when writing is done at this time, the user memory of the PC CPU may be broken.

Execute this function after confirming the type of memory cassette and parameter settings.

Memory cassette model name	Block Nos. whose errors are not detected		
	A2, A3CPU	A2N, A3N CPU	A3H CPU
A3MCA-12	No. 10, No. 11		
A3MCA-18	-	No. 13 to No. 28	
A3MCA-24	-	No. 13 to No. 20	No. 13 to No. 28
A3MCA-40	-		No. 21 to No. 28

(Refer to the Instruction Manual of UTLP-FN1.)

8. READING AND WRITING DATA STORED IN THE PC CPU MELSEC-A

8.5.3 Batch read of extension file register

When batch read of extension file register is done, the command and response format are as follows:

(1) Communications in binary code

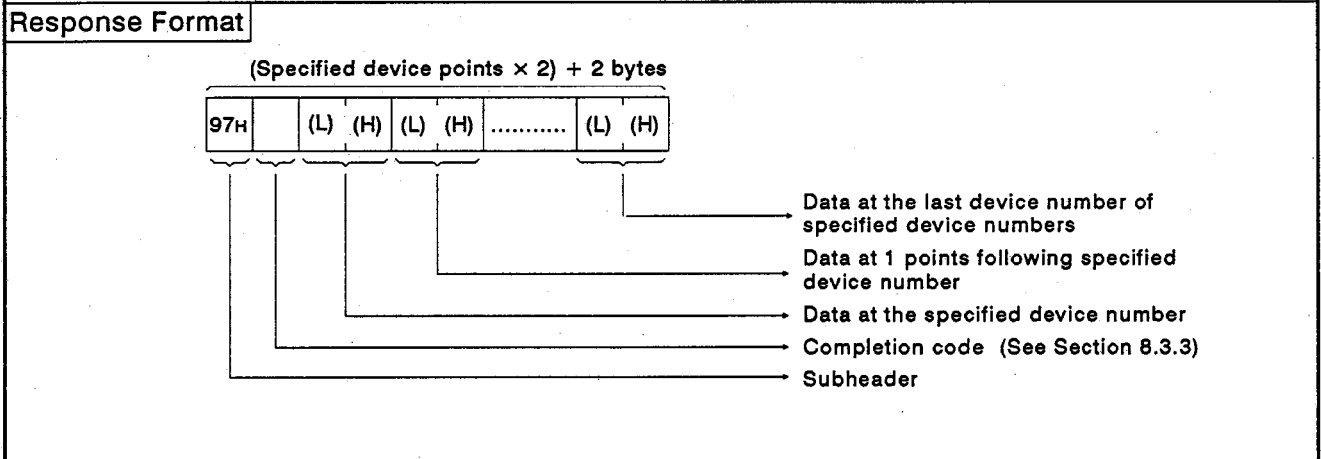
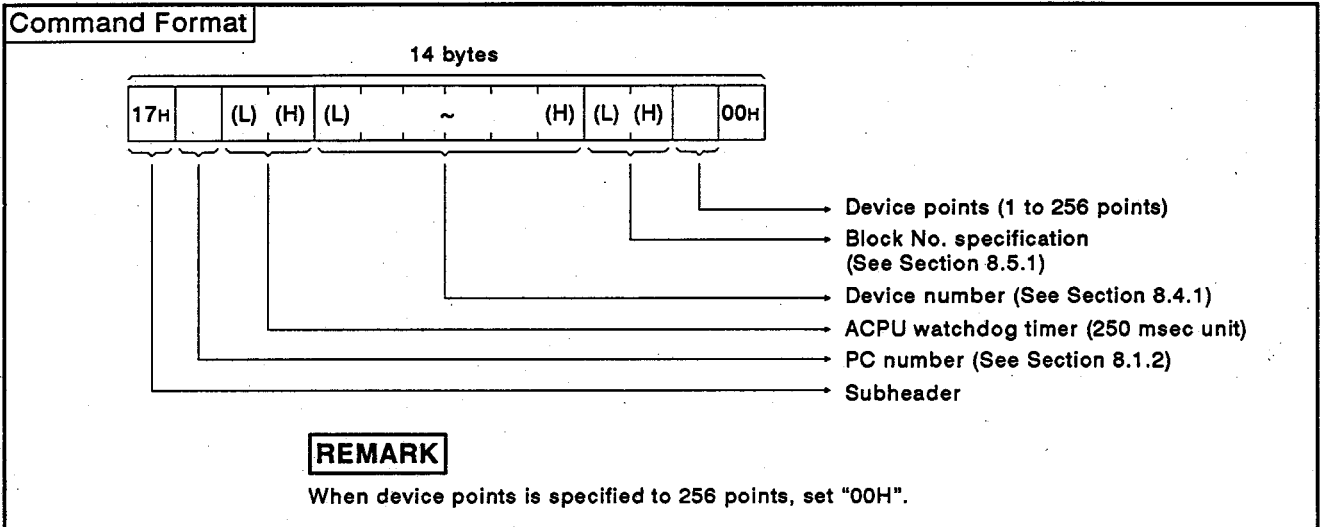

Example: When reading data at R70 to 72 of the extension file register block No.2 of a PC CPU loaded with AJ71E71

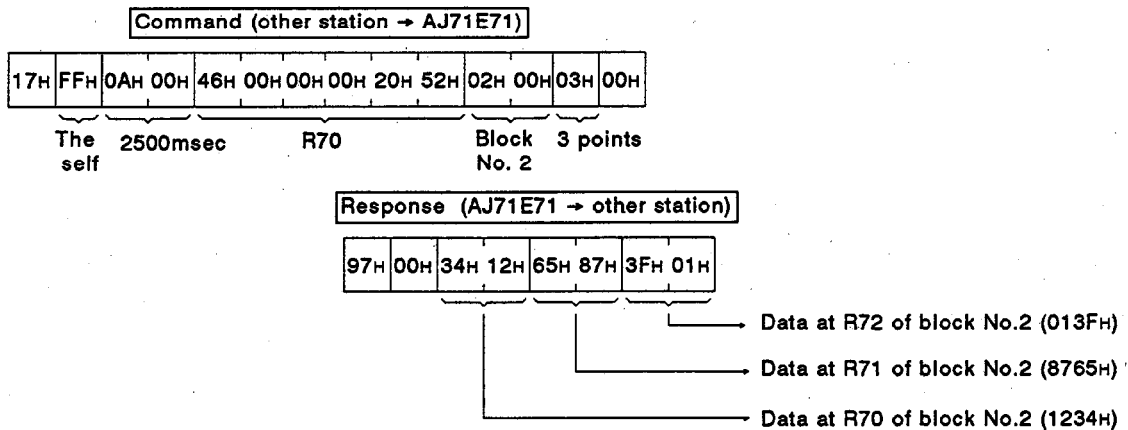

8. READING AND WRITING DATA STORED IN THE PC CPU

MELSEC-A

(2) Communications in ASCII code

Command Format

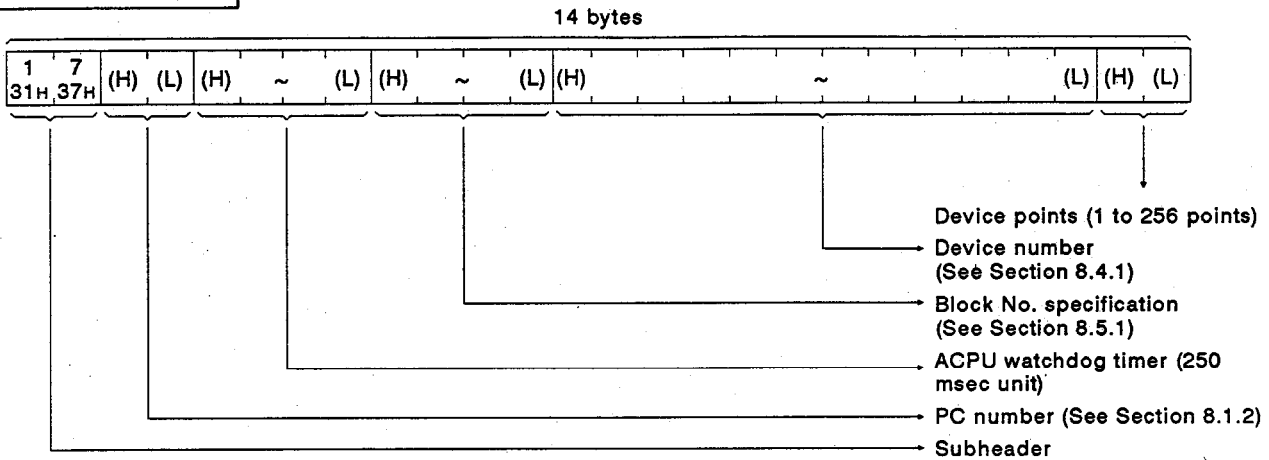

REMARK

When device points is specified to 256 points, set "00H".

Response Format

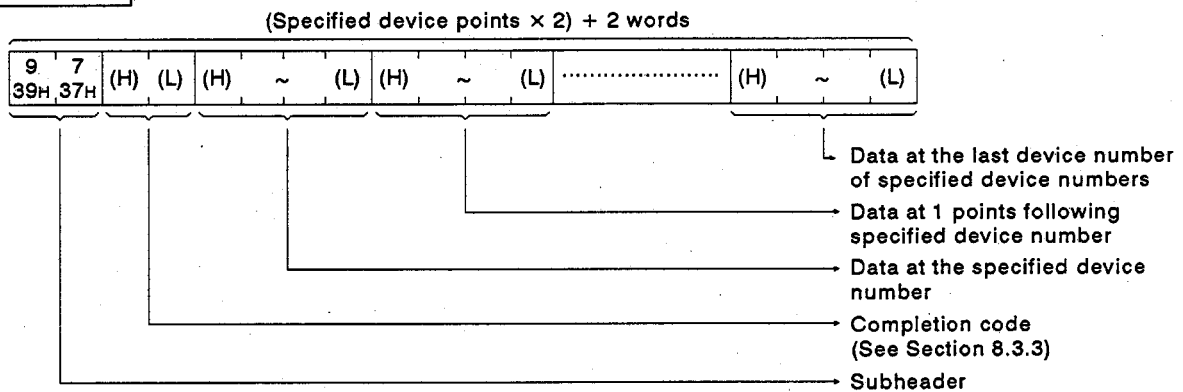

Example : When reading data at R70 to 72 of the extension file register block No.2 of a PC CPU loaded with AJ71E71

Command (Other node → AJ71E71)

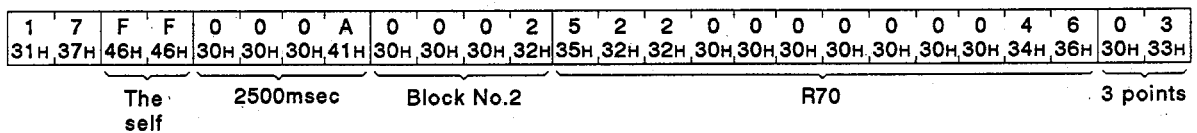

Response (AJ71E71 → other station)

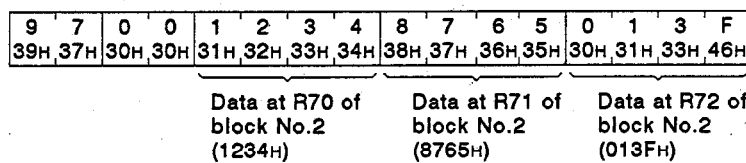

8. READING AND WRITING DATA STORED IN THE PC CPU MELSEC-A

8.5.4 Batch write of extension file register

When batch write of extension file register is done, the command and response format are as follows:

(1) Communications in binary code.

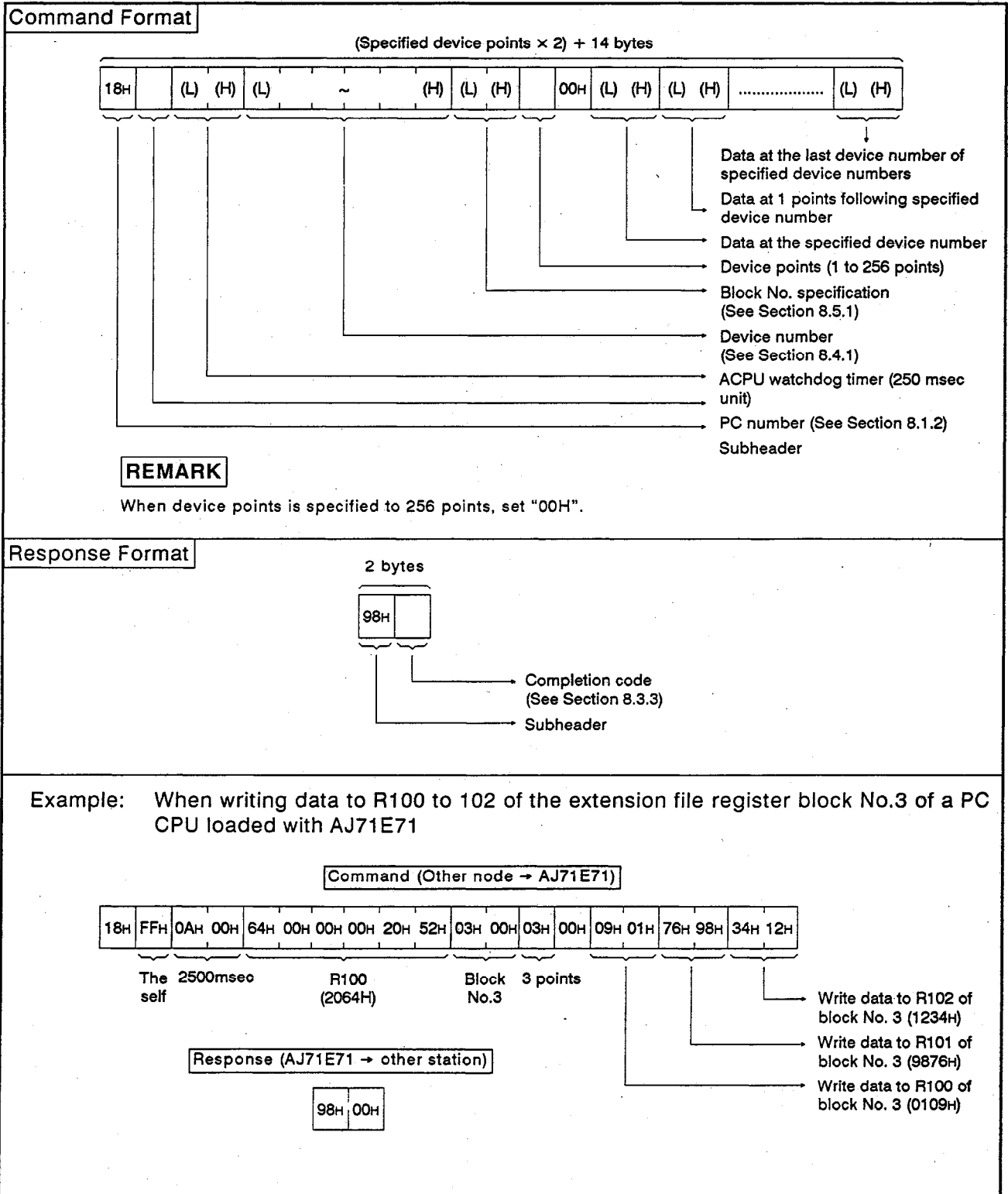

8. READING AND WRITING DATA STORED IN THE PC CPU

MELSEC-A

(2) Communications in ASCII code

Command Format

(Specified device points × 2) + 14 words

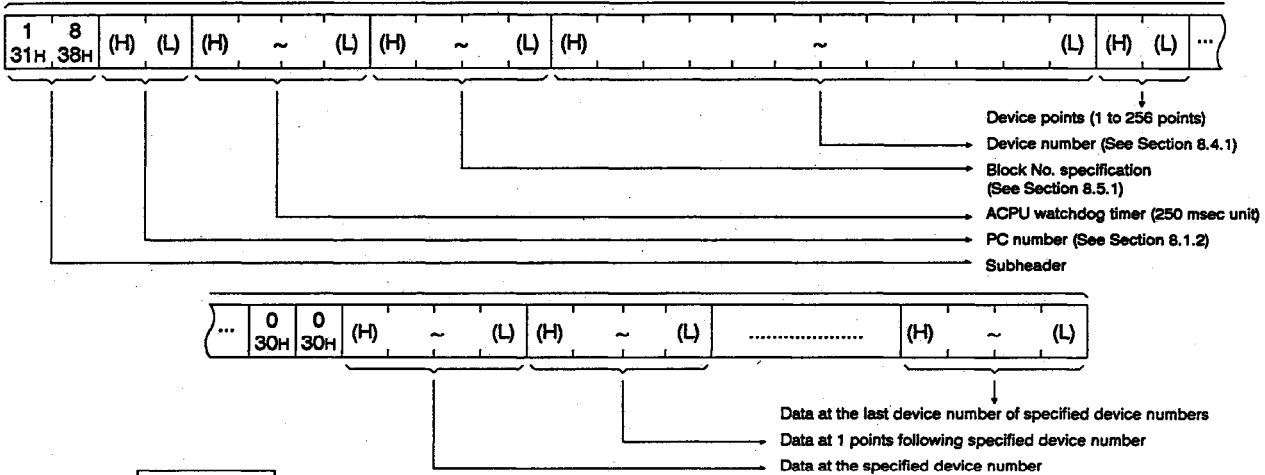

REMARK

When device points is specified to 256 points, set "3030H".

Response Format

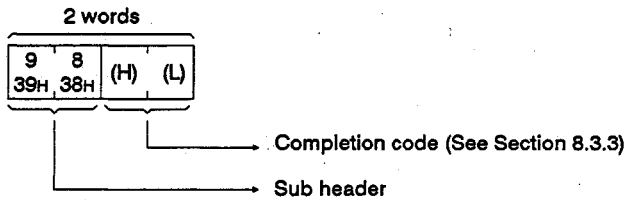

Example: When writing data to R100 to 102 of the extension file register block No.3 of a PC CPU loaded with AJ71E71

Command (Other station → AJ71E71)

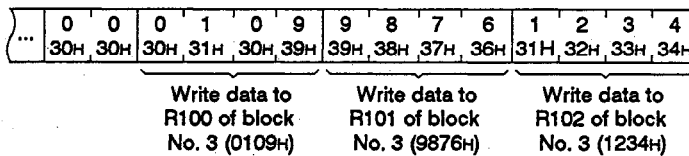
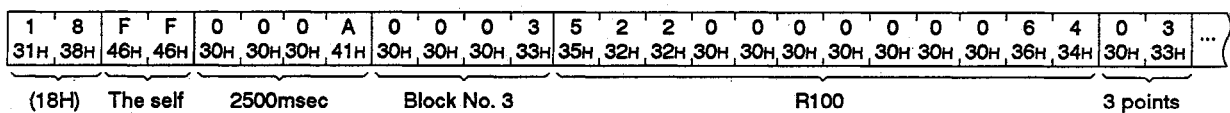

Response (AJ71E71 → Other station)

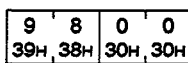

8. READING AND WRITING DATA STORED IN THE PC CPU

MELSEC-A

8.5.5 Test (random write) of extension file register

When an extension file register is specified at random and is written, the command and response format are as follows:

(1) Communications in binary code

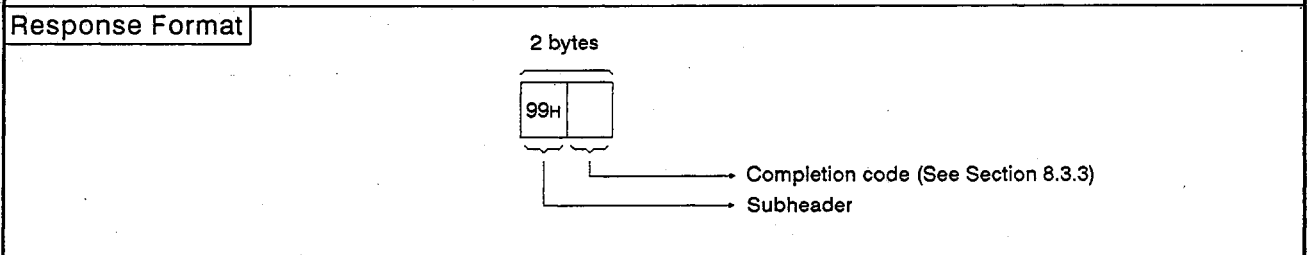
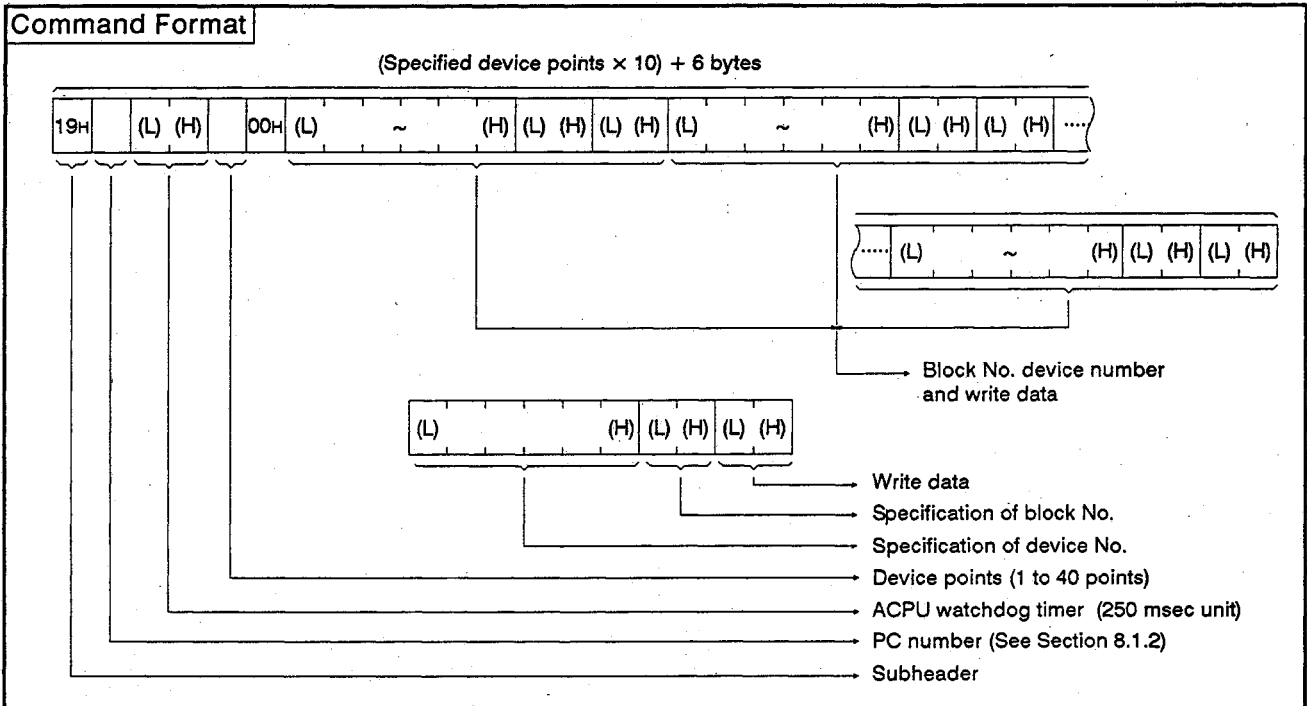

Example: When writing data to R26 of block No.2 and R19 of block No.3 of a PC CPU loaded with AJ71E71

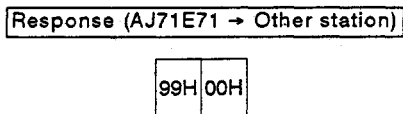
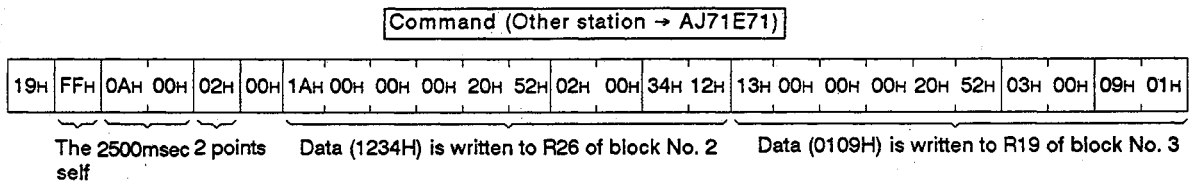

8. READING AND WRITING DATA STORED IN THE PC CPU

MELSEC-A

(2) Communications in ASCII code

Command Format

(Specified device points × 10) + 6 words

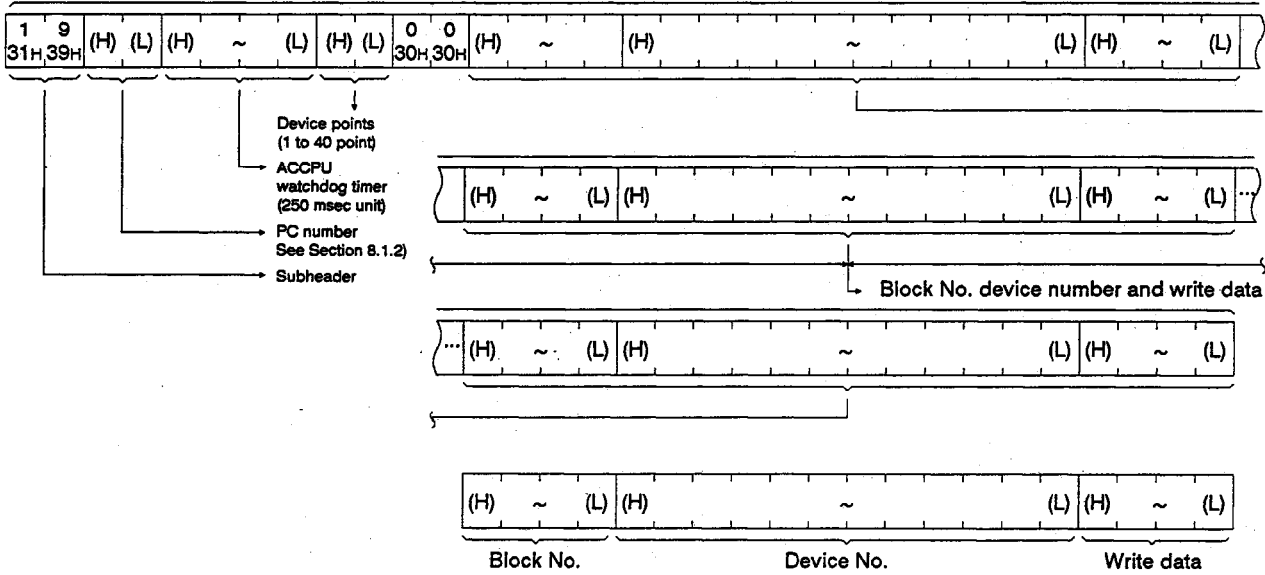

Response Format

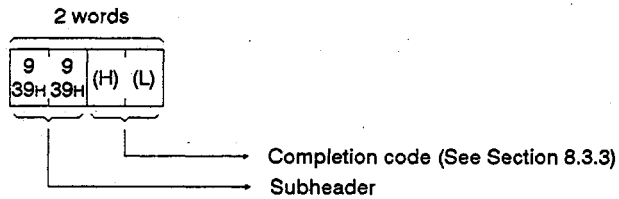

Example: When writing data to R26 of block No. 2 and R19 of block No. 3 of a PC CPU loaded with AJ71E71.

Command (Other station → AJ71E71)

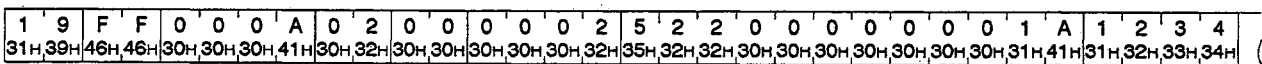

The self 2500msec 2 points

Data (1234H) is written to R26 of block No. 2

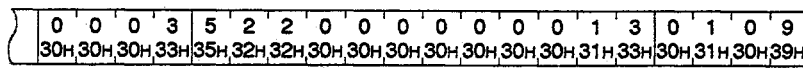

Data (0109H) is written to R19 of block No. 3

Response (AJ71E71 → Other station)

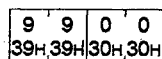

8.5.6 Monitoring extension file register

The ON/OFF state or data of an extension file register in the PC CPU can be monitored by a communicating station by transmitting a monitoring command from the communications station.

The type and the number of an extension file register to be monitored must be registered in advance to AJ71E71.

When an extension file register is read by using batch read processing, the devices are read by serial device numbers.

The block No. and device number of an extension file register can be specified at random in case of the read by the monitoring function.

(1) Procedure for monitoring

The chart below shows the operation procedure to execute monitoring.

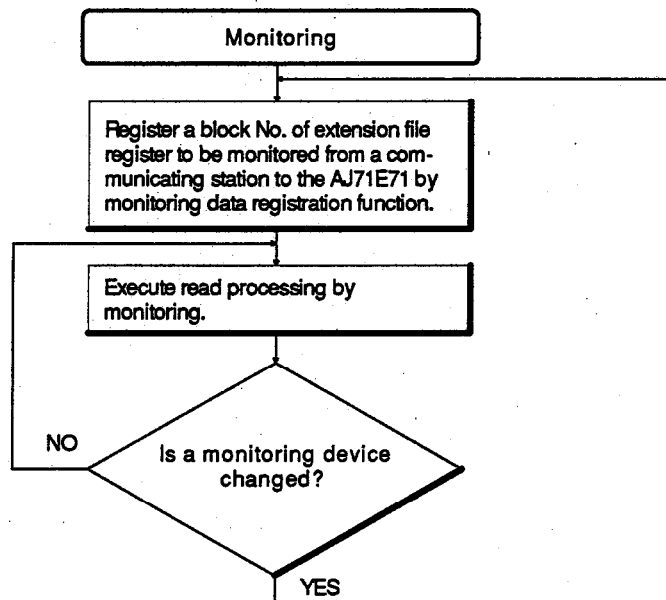
**POINTS**

(1) Be sure to execute monitoring after monitoring data registration according to the above-mentioned operation procedure.

When monitoring is executed without completing monitoring data registration, an error (completion code 57H) occurs.

(2) When a power supply is turned OFF, and the PC CPU is reset, the contents of monitoring data registration are cleared.

(3) The bit unit and the word unit of device memory and the extension file register can be registered by monitoring data registration.

8. READING AND WRITING DATA STORED IN THE PC CPU MELSEC-A

(2) Monitoring data registration

The command and response formats are as follows when a monitoring device number of extension file register is registered:

(a) Communications in binary code

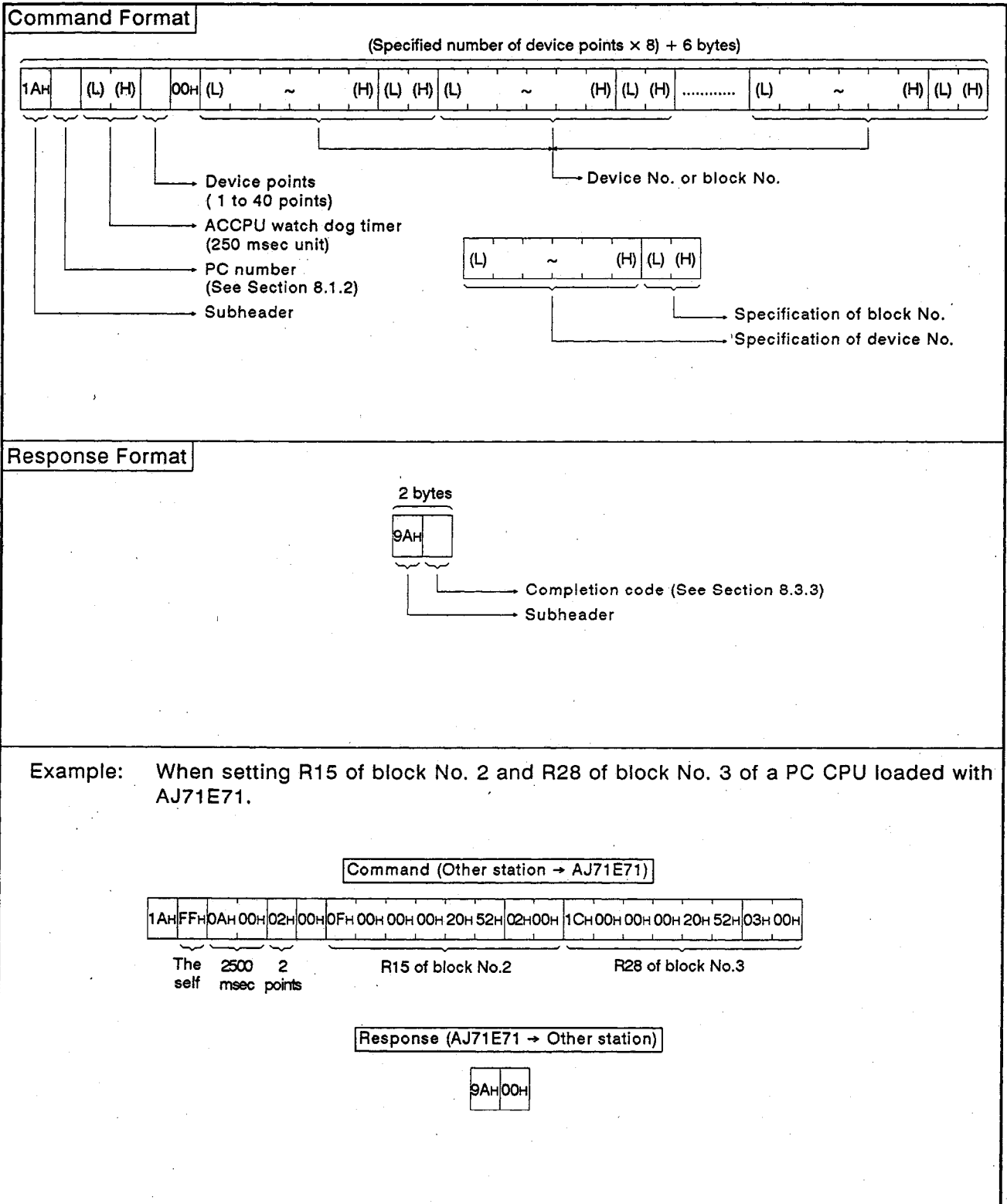

8. READING AND WRITING DATA STORED IN THE PC CPU MELSEC-A

(b) Communications in ASCII code

Command Format

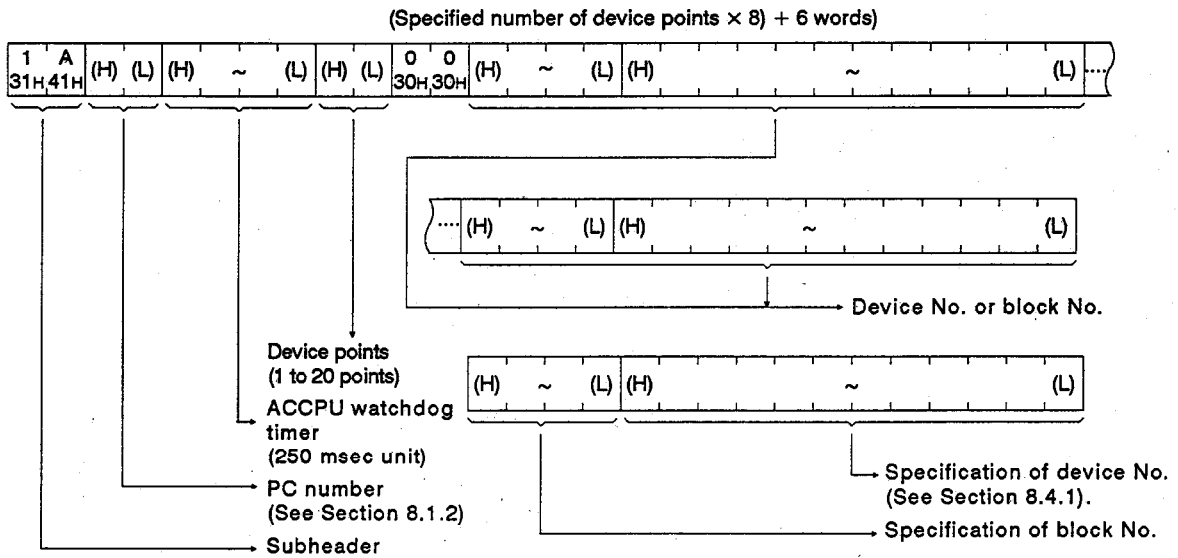

Response Format

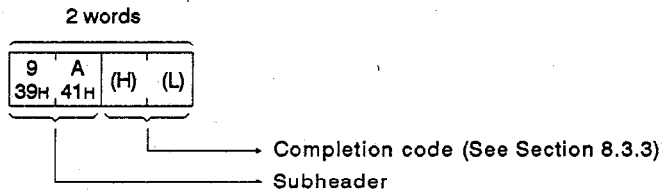

Example: When setting R15 of block No.2 and R28 of block No.3 of a PC CPU loaded with AJ71E71

Command (Other station → AJ71E71)

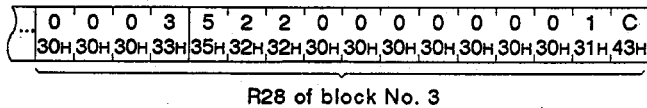
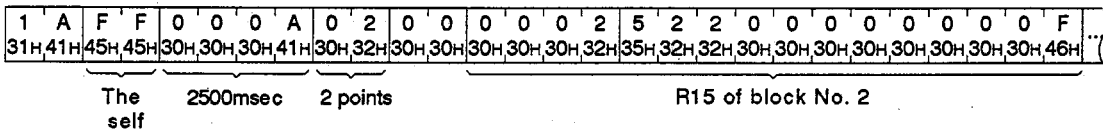

Response (AJ71E71 → Other station)

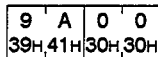

8. READING AND WRITING DATA STORED IN THE PC CPU MELSEC-A

(3) Monitoring

The command and response formats are as follows when an extension file register set by monitoring data registration is registered:

(a) Communications in binary code

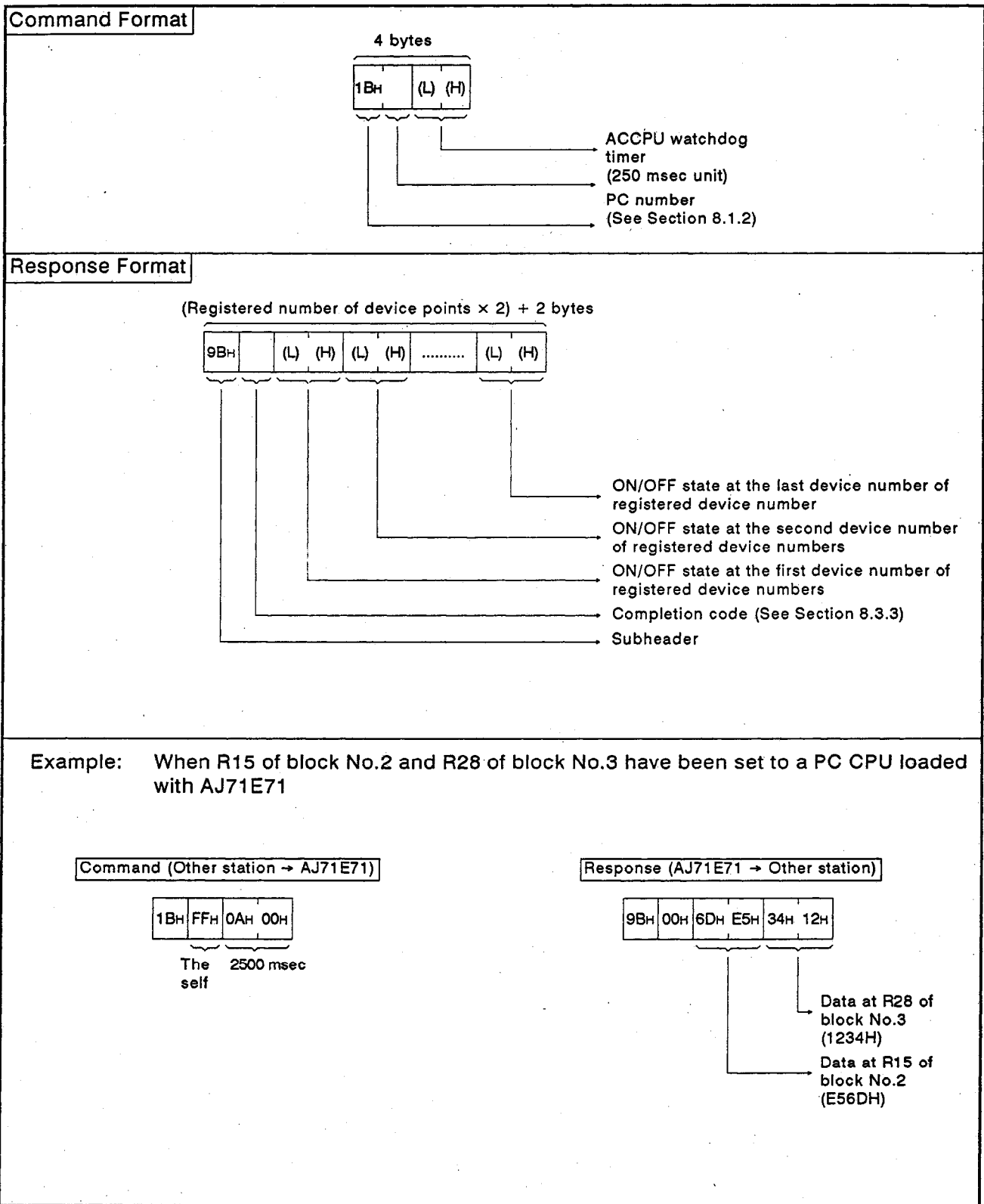

8. READING AND WRITING DATA STORED IN THE PC CPU

MELSEC-A

(b) Communications in ASCII code

Command Format

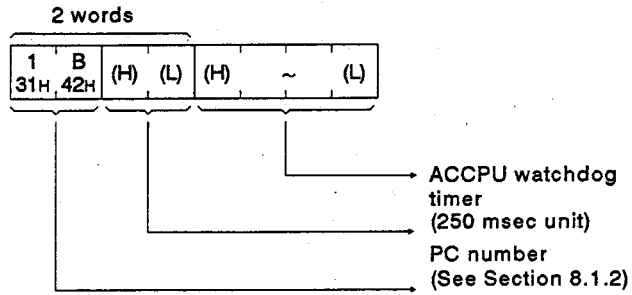

Response Format

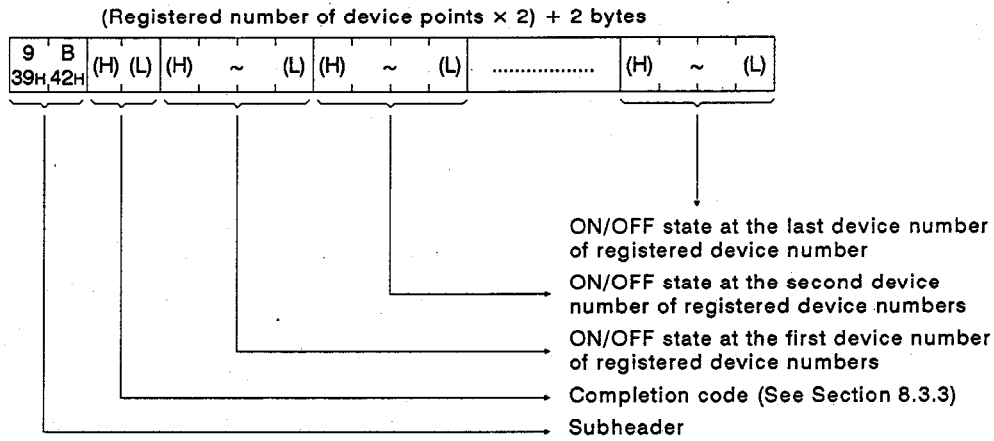

Example: When R15 of block No.2 and R28 of block No.3 have been set to a PC CPU loaded with AJ71E71

Command (Other station → AJ71E71)

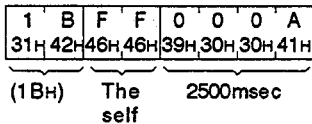

Response (AJ71E71 → Other station)

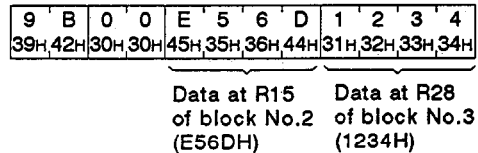

8. READING AND WRITING DATA STORED IN THE PC CPU

MELSEC-A

8.5.7 Direct read/write of extension file registers

- (1) The AnACPU dedicated commands used for direct read and direct write of extension file registers are described below.

These dedicated commands are used to access the extension file register of block numbers 0 to 256 by directly designating the address, which begins with address 0 in block number 1, as the device number. The address numbers used to access the extension file register go from 0 to "the usable number of blocks × 8192 points".

Item	Com- mand	Processing	Number of Points Processed per Communica- tions	State of PC CPU		
				During STOP	During RUN	
					SW22 ON	SW22 OFF
Direct read	3BH	Reads in units of points (words) by designating the extension file register in successive numbers.	256 points	o	o	o
Direct write	3CH	Writes data to the extension file register in units of points (words) by designating the extension file register in successive numbers.	256 points	o	o	x

Note : oExecutable
x.....Not executable

- (2) Device numbers of extension file registers

- (a) Device number range

Range: 0 through [(the number of usable blocks × 8192) – 1]

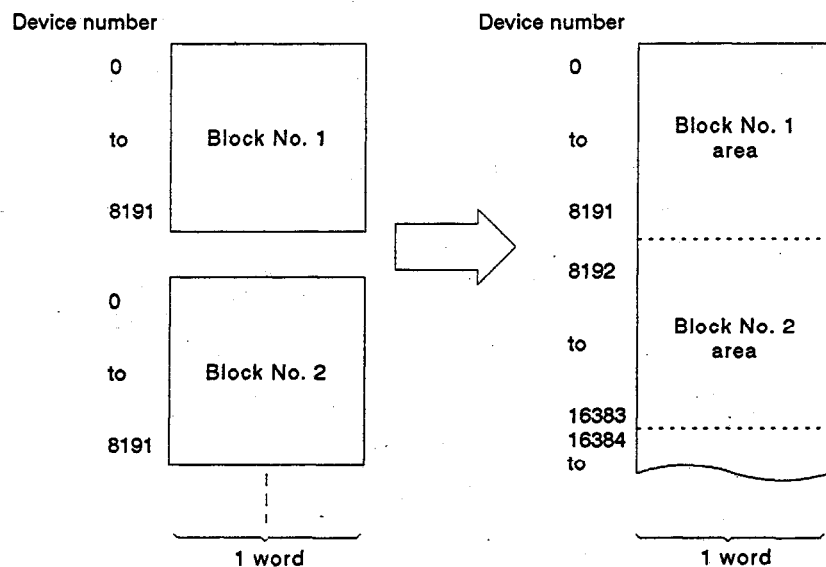

The device numbers to be used for direct read/write are assigned automatically in the order from devices of small block No. to devices of large block No. among block Nos. 1 to 28.

8. READING AND WRITING DATA STORED IN THE PC CPU MELSEC-A

And, the device numbers that can be specified change according to the type of memory cassette and parameter settings of the PC CPU.

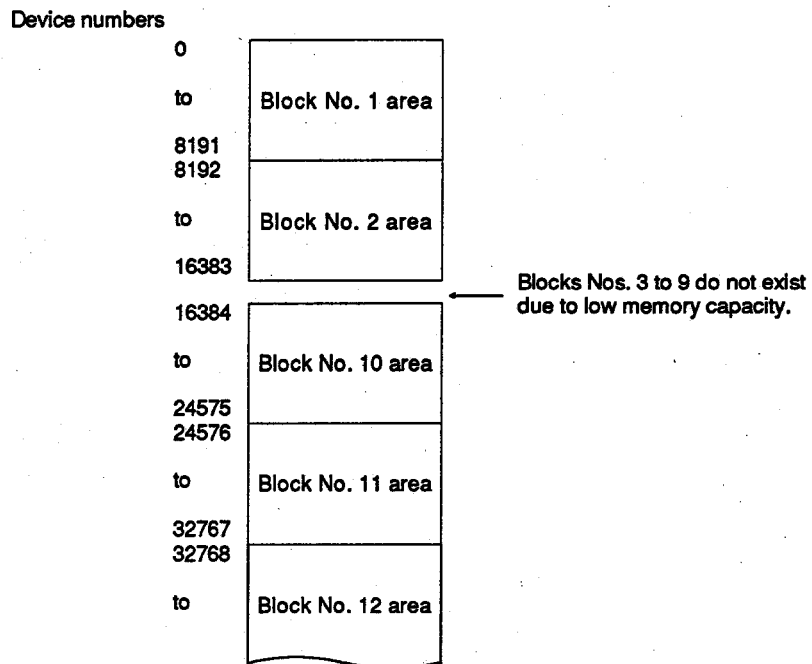

POINTS

- (1) Only when doing read/write of data using the extension file registers of block Nos. 0 to 256, the AnACPU dedicated commands can be used.
And, the AnACPU dedicated commands can be used independently of the existence of file register setting done with parameter.
- (2) Use command shown in Section 8.5.6 when access is made to file registers (R) set with parameter or the specified block numbers.
- (3) A head device number to be specified by the AnACPU dedicated command is calculated as follows.

When the device number in the nth block from the head is m (0 to 8191)

$$\text{Head device number} = (n - 1) \times 8192 + m$$

8. READING AND WRITING DATA STORED IN THE PC CPU

MELSEC-A

(3) Batch read of extension file register

The comand and response formats are as follows when batch read fo extension file register is done:

(a) Communications in binary code

Command Format

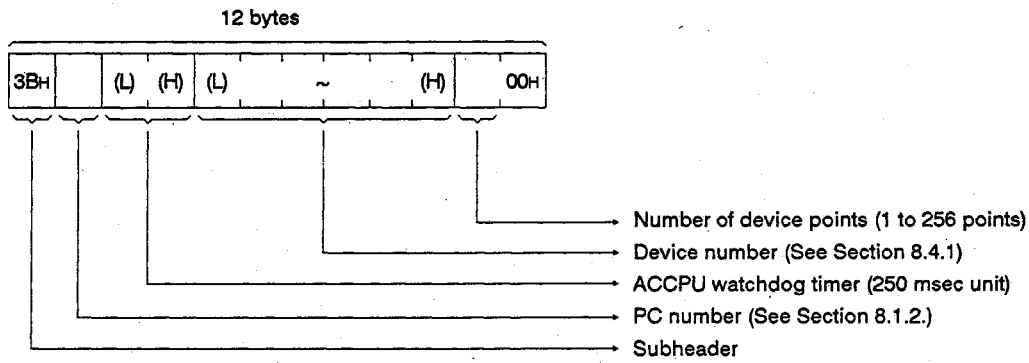

REMARK

When number of device points is specified to 256 points, set "00H"

Response Format

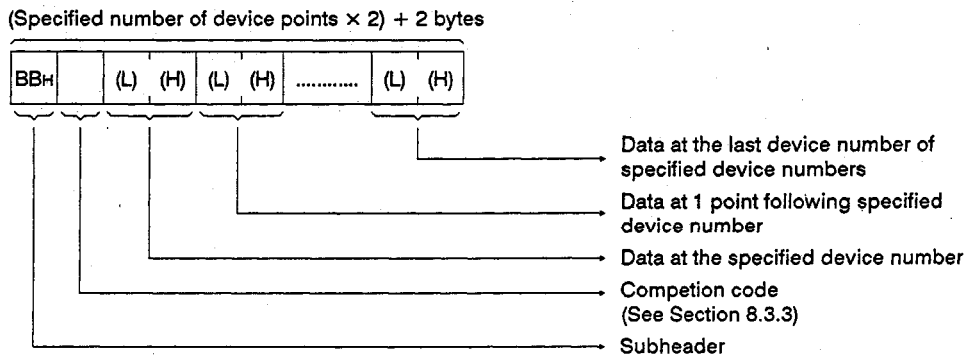

Example: When reading at R70 to 73 of the extension file register block No. 2 of a PC CPU loaded with AJ71E71.

Command (Other station → AJ71E71)

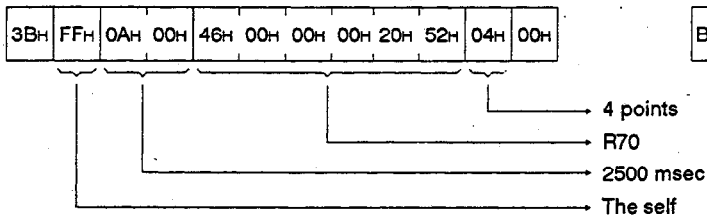

Response (AJ71E71 → Other station)

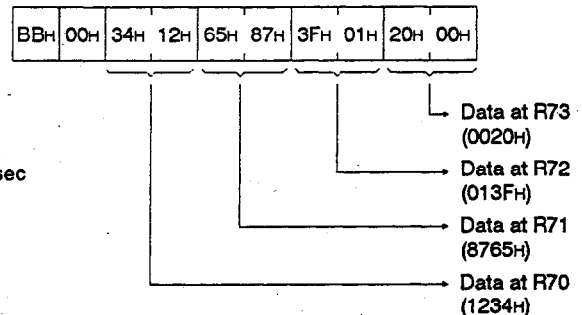

8. READING AND WRITING DATA STORED IN THE PC CPU MELSEC-A

(b) Communications in ASCII code

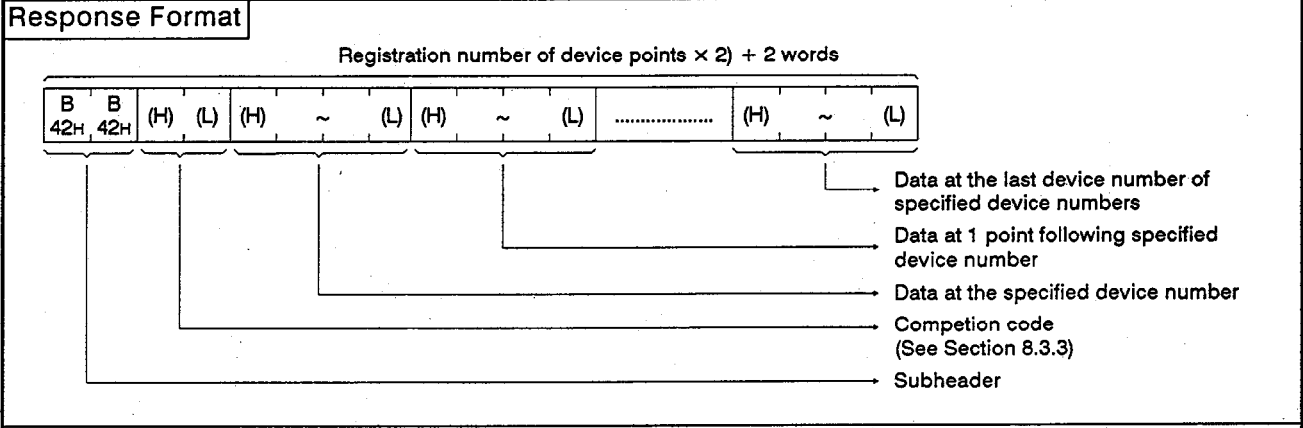
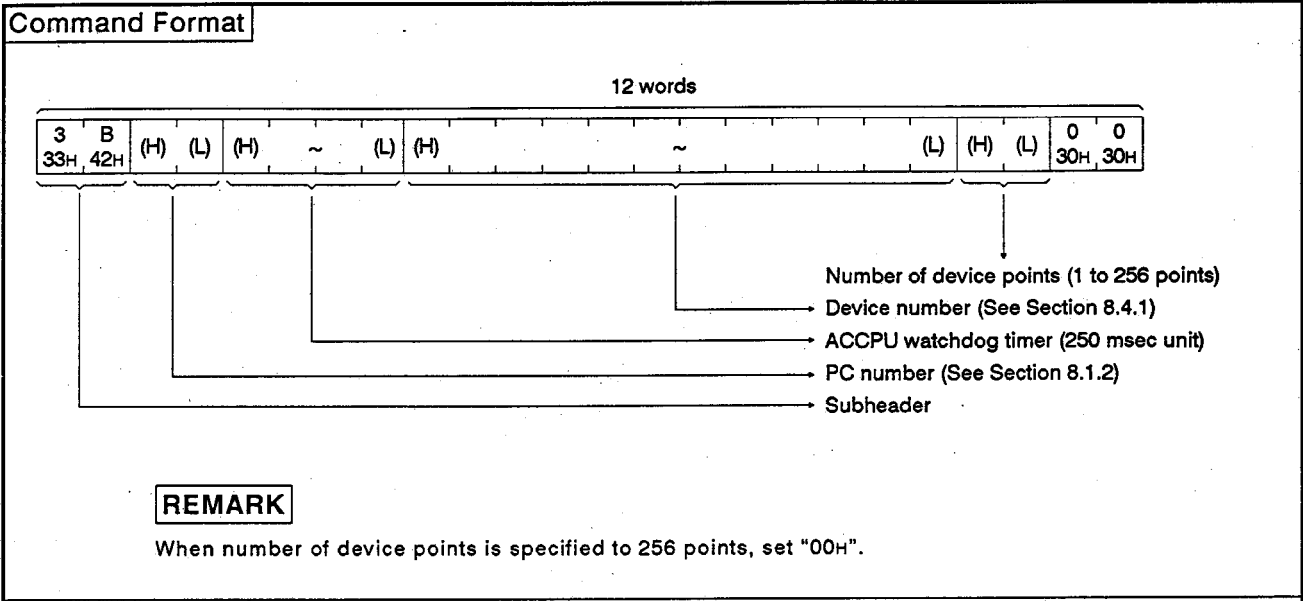

Example: When reading data at R70 to R72 of the extension file register block No. 2 of a PC CPU loaded with AJ71E71.

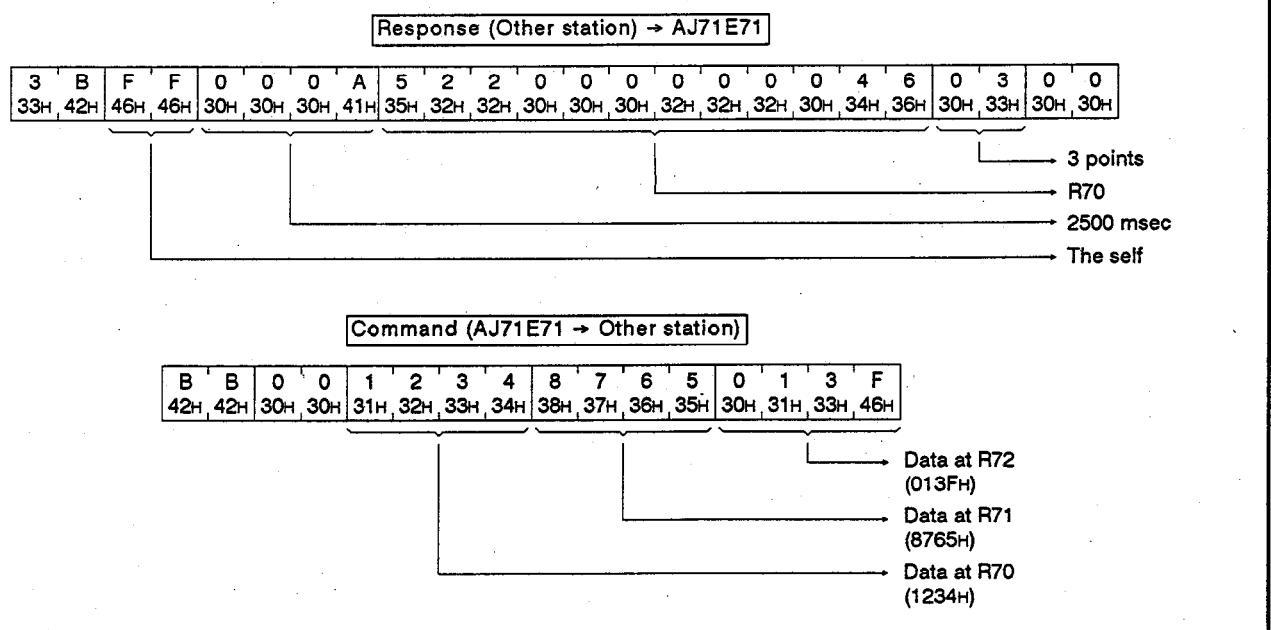

8. READING AND WRITING DATA STORED IN THE PC CPU

MELSEC-A

(4) Batch writ of extension file register

The command and response formats are as follows when batch write of extension file register is done:

(a) Communications in binary code

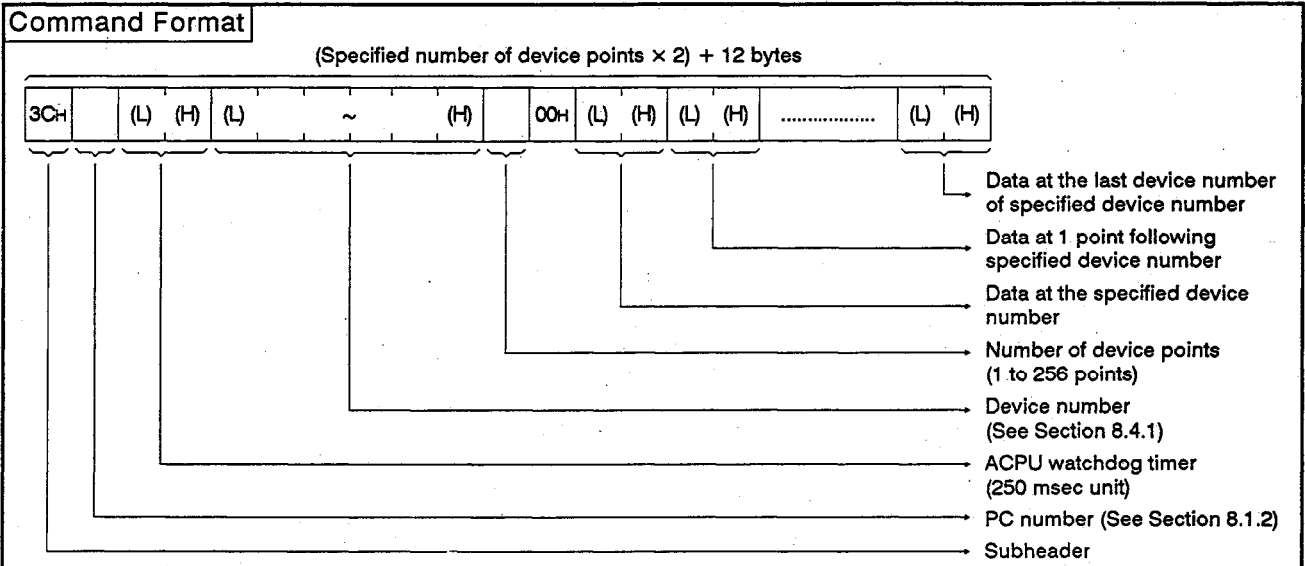

REMARK

When number of device points is specified to 256 points, set "00H".

Response Format

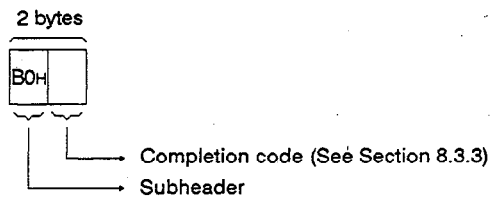

Example: When writing data to R100 to 102 of the extension file register block No. 2 of a PC CPU loaded with AJ71E71.

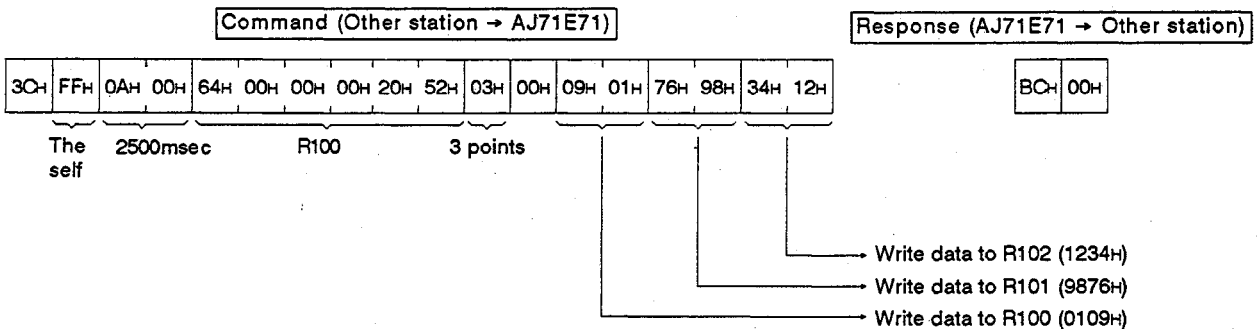

8. READING AND WRITING DATA STORED IN THE PC CPU

MELSEC-A

(b) Communications in ASCII code

Command Format

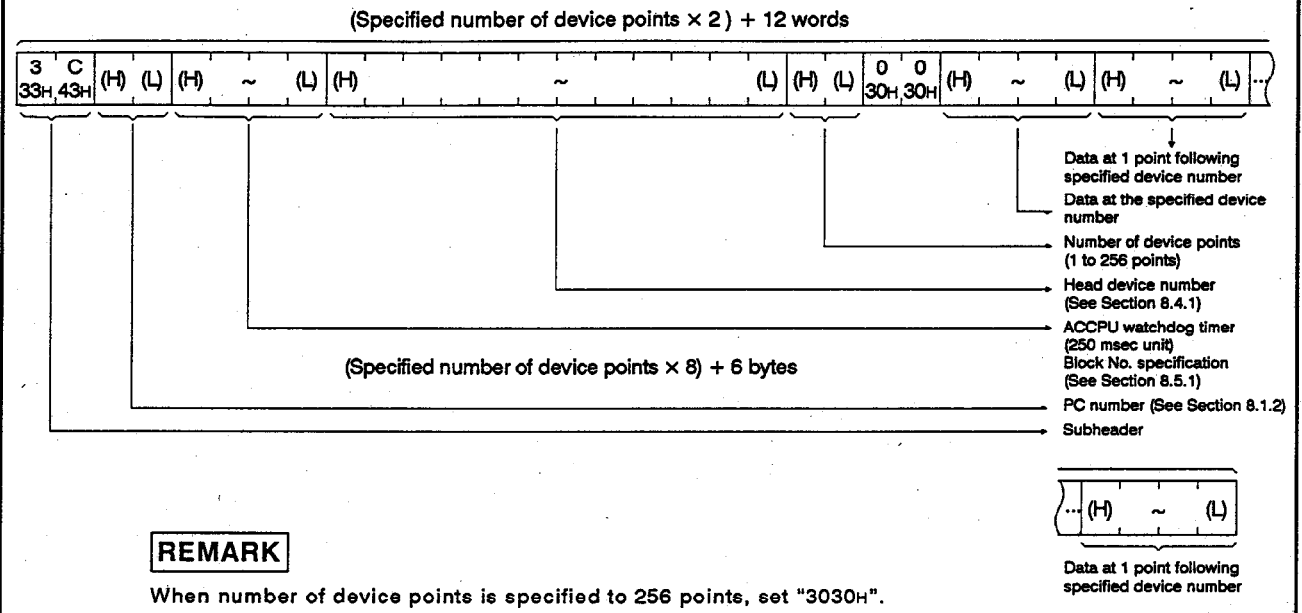

Response Format

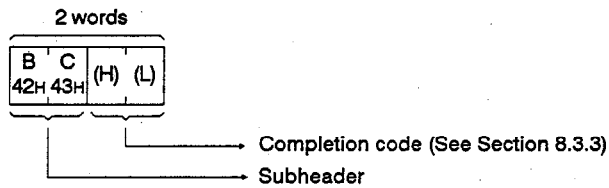

Example: When writing data to R100 to 102 of the extension file register block No. 2 of a PC CPU loaded with AJ71E71

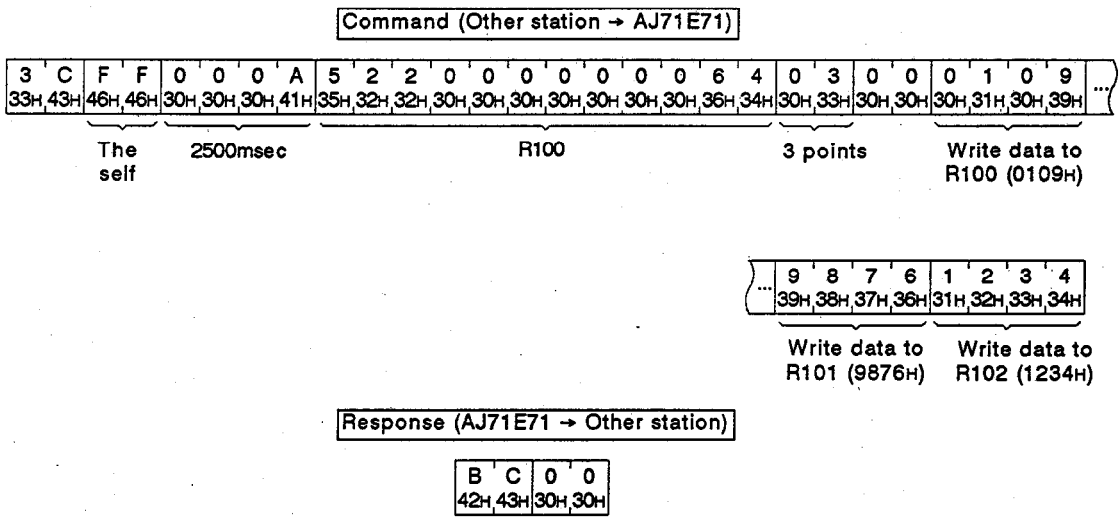

8. READING AND WRITING DATA STORED IN THE PC CPU

MELSEC-A

8.6 Command/response format for read/write of special-function module data

This section explains the specification and method of control protocols, and the examples, when data of the buffer memory area of a special-function module is read, or when data is written to the buffer memory area.

If this command is used, the buffer memory of a special-function module is accessed in byte units.

8.6.1 Commands and method of specification

- (1) Table 8.7 shows the function of read/write of special-function module data.

Table 8.7 Function

Item	Command/ Response Classifica- tion	Processing	Number of Points Processed per Communications	State of PC CPU		
				During STOP	During RUN	
					SW22 ON	SW22 OFF
Batch read	0EH	Reads from special function module buffer memory.	256 words (128 bytes)	o	o	o
Batch write	0FH	Writes to special function module buffer memory.		o	o	x

Note : o.....Executable
x.....No

- (2) Model names of the special-function modules that can be linked, buffer memory head addresses and module numbers.

Special Function Module Name	Buffer Memory Head Address (hexadecimal)	Module Number When Loaded in Slot No. 0
A68AD(S2) analog-digital converter module	80H	01H
A62DA(S1) digital-analog converter module	10H	01H
A84AD analog-digital converter module	10H	02H
AD61(S1) high-speed counter module	80H (80H is unused)	01H
AD71(S1) positioning module	200H	01H
AD71-S2 positioning module	200H	01H
AD72 positioning module	200H	02H
A61LS position detection module	80H	01H
AD51. intelligent communications module	800H	02H
AJ71C24-S6 computer link module	1000H	01H
A81CPU PID control module	200H	03H
AJ71E71 Ethernet interface module	400H	01H

8. READING AND WRITING DATA STORED IN THE PC CPU MELSEC-A

(3) Special-function module buffer memory

Each address of the special-function module buffer memory consists of 16 bits (1 word), and read/write between a PC CPU and a special-function module uses the FROM/TO instruction.

When a communicating station reads and writes data using buffer memory of a special-function module through an AJ71E71, an address is processed in 8-bit (1 byte) units.

The address (hexadecimal) to be specified by a communicating station is calculated as follows by using an address for the FROM/TO instruction.

Address to be specified (Hexadecimal) = (Address for the FROM/TO instruction × 2) is converted into hexadecimal + Head address of each module

Example When address 0 (preset value of CH1) of the FROM/TO instruction of the AD61 high-speed counter module is specified:

$$\begin{array}{rcl} \text{Specified address} & = & \text{FROM/TO instruction address} \times 2 + \text{Head address} \\ 82\text{H} & & 2\text{H} \qquad \qquad \qquad 80\text{H} \end{array}$$

When a communicating station makes an access to buffer memory of a special-function module through an AJ71E71, the example of a format using an AD61 is as follows.

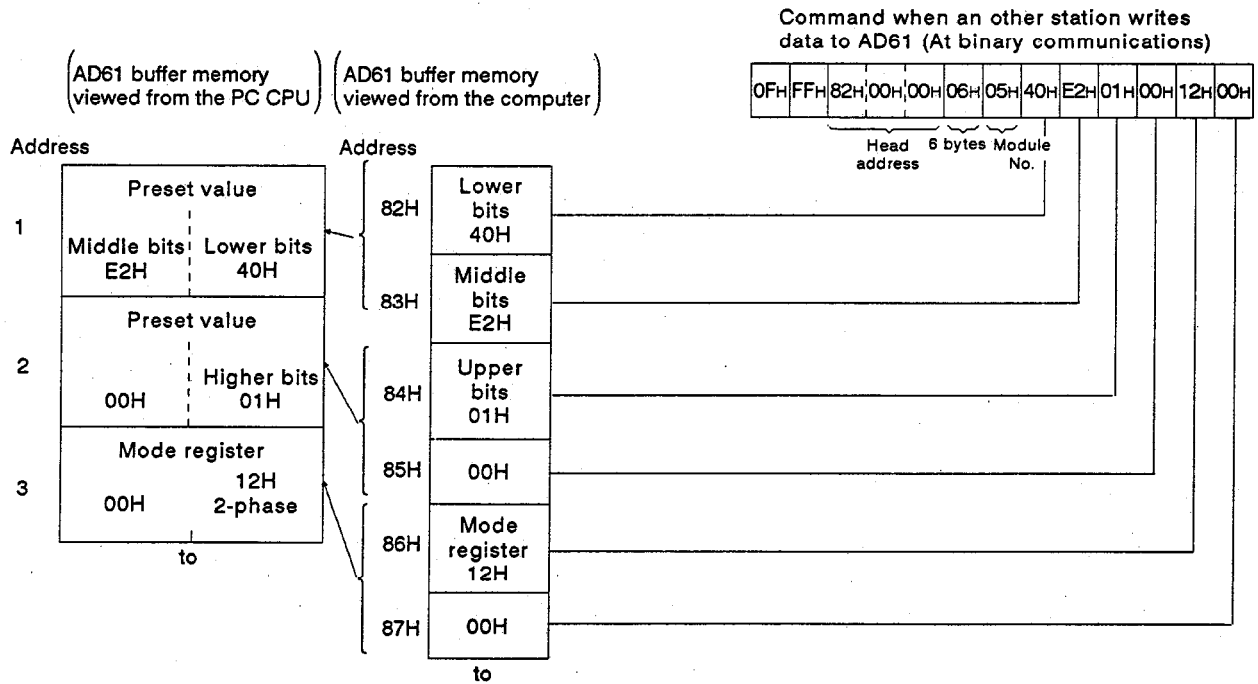

POINT

Buffer memory of each special-function module has a read/write area, a read-only area, a write-only area and a system-use area.

Execute this function according to the instructions of the operation manual of each module.

When wrong read/write is done, an error sometimes occurs in the PC CPU or in each special-function module.

8. READING AND WRITING DATA STORED IN THE PC CPU

MELSEC-A

8.6.2 Special-function module number to be used with a command

- (1) When the final I/O address of a special-function module is expressed in 3 digits, special-function module number specified by a control protocol is expressed by its upper 2 digits.

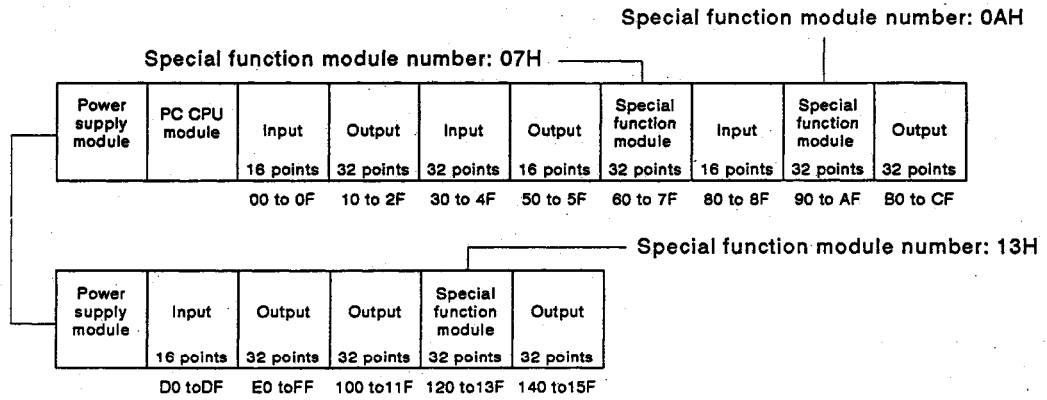

- (2) Precautions when a special-function module occupies 2 slots

The number of occupied inputs/outputs of each slot is provided to every module when a special-function module which occupies 2 slots is used.

A special-function module number is expressed with 2 digits on the final address of a slot allocated to a special-function module.

Refer to the User's Manual of each special-function module for the allocation of every slot of each module.

- (a) When a first half slot is allocated as an empty slot (AD72 and A84AD, etc.)

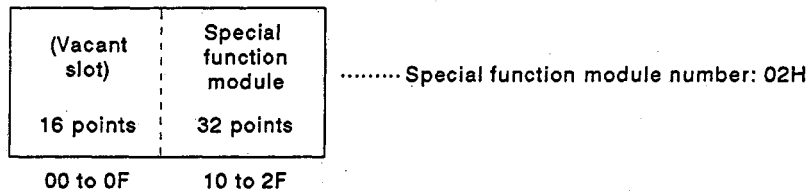

- (b) When a second half slot is allocated as an empty slot (A61LS, etc.)

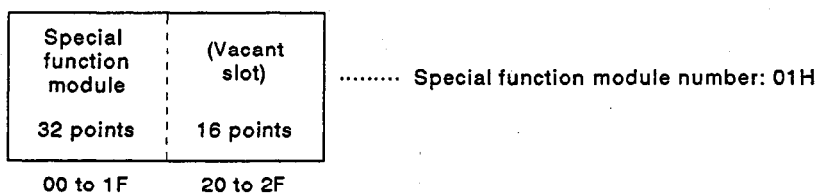

8. READING AND WRITING DATA STORED IN THE PC CPU

MELSEC-A

- (c) When a special-function module and an I/O allocation are used together (A81CPU, etc.)

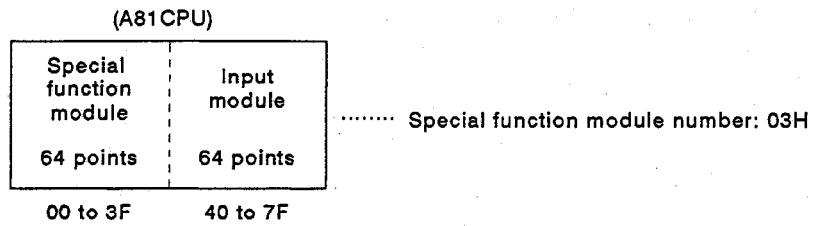

- (3) Module number of a special-function module in a MELSECNET remote station

The module number of a special-function module in a MELSECNET remote station is arranged according to the link parameter settings in the MELSECNET master station.

L/R	M ← L		M → R	M ← R	M → L/R		M ← L/R	
	B	W	W	W	Y	X/Y	X	Y/X
R1	----	----	29C-309	0F9-15E	400-48F	000-08F	430-44F	030-04F
R2	----	----	215-24F	080-0A3	510-67F	010-17F	500-65F	000-15F
R3	----	----	1B6-214	15F-1B5	270-32F	050-10F	220-28F	000-06F
	-	-	-	-	-	-	-	-
	-	-	-	-	-	-	-	-
	-	-	-	-	-	-	-	-
	-	-	-	-	-	-	-	-

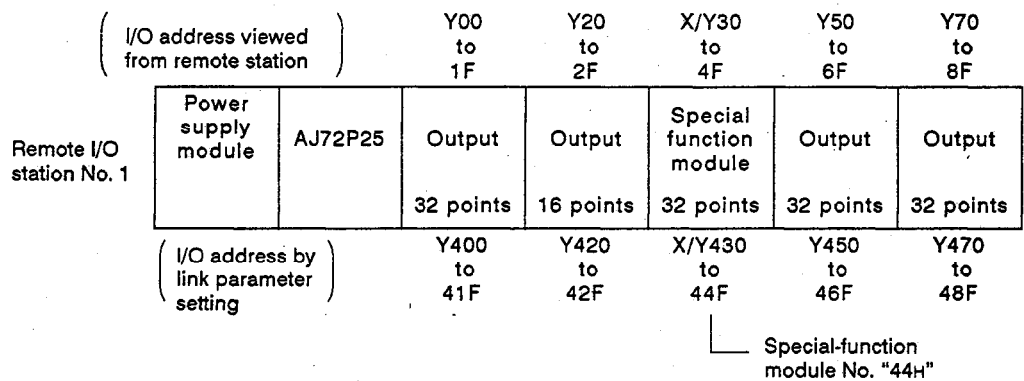

8. READING AND WRITING DATA STORED IN THE PC CPU

MELSEC-A

8.6.3 Reading special-function module buffer memory

The command and response formats as follows when data is read from the buffer memory of a special-function module:

(1) Communications in binary code

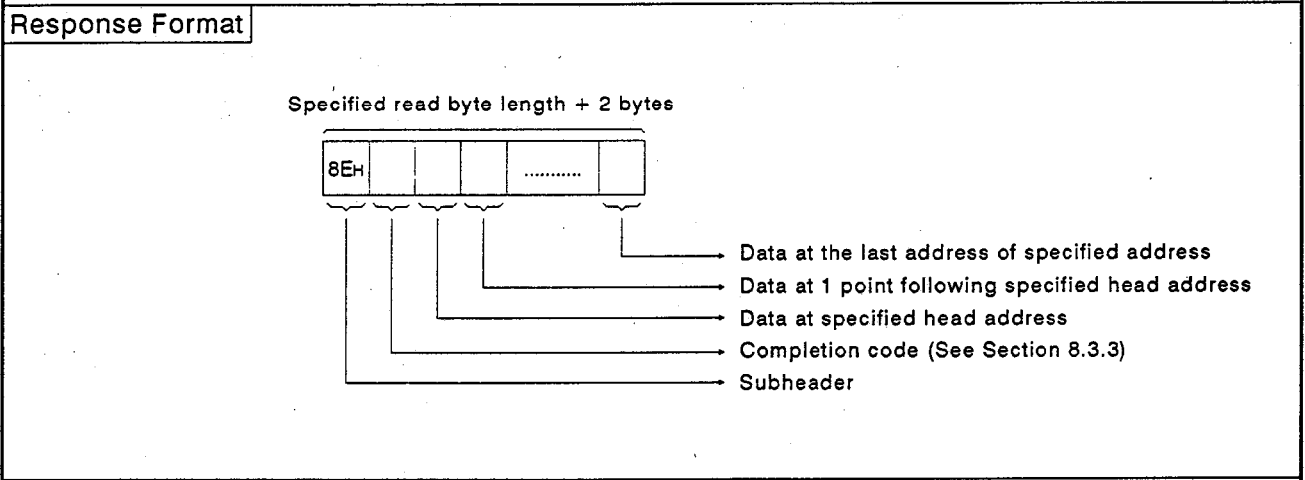
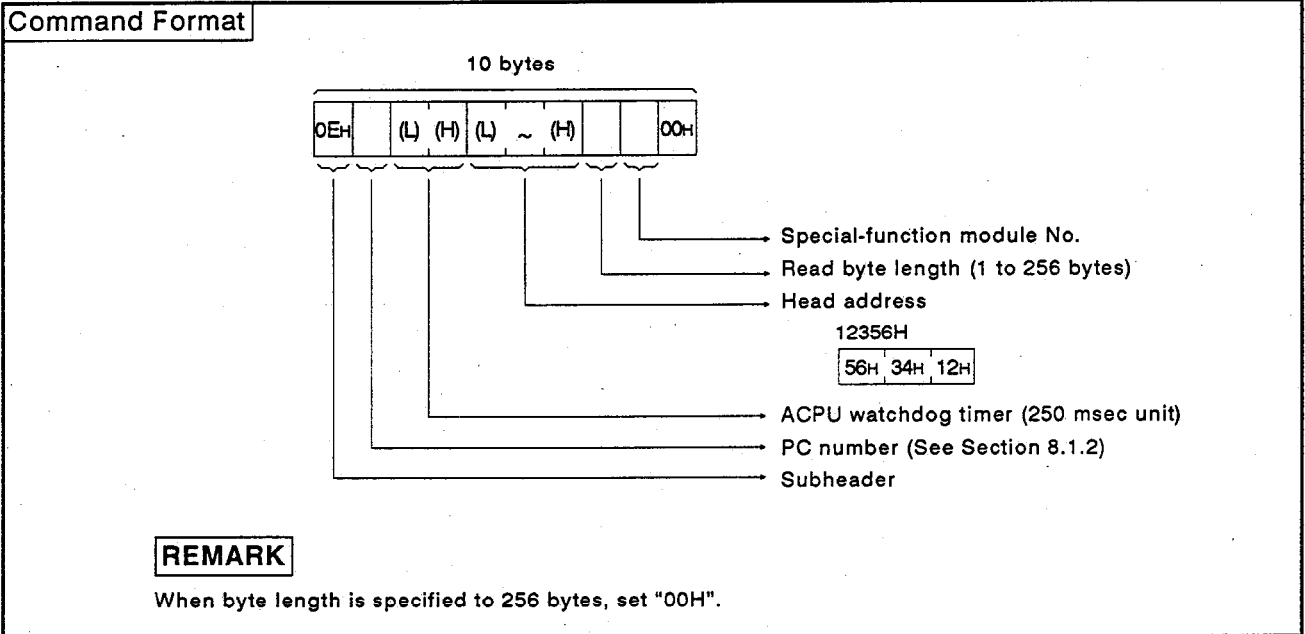

Example: When reading data of 7F0H to 7F3H of special-function modules (X and Y120 to 13F (module No. 13 H)) of a same station loaded with AJ71E71

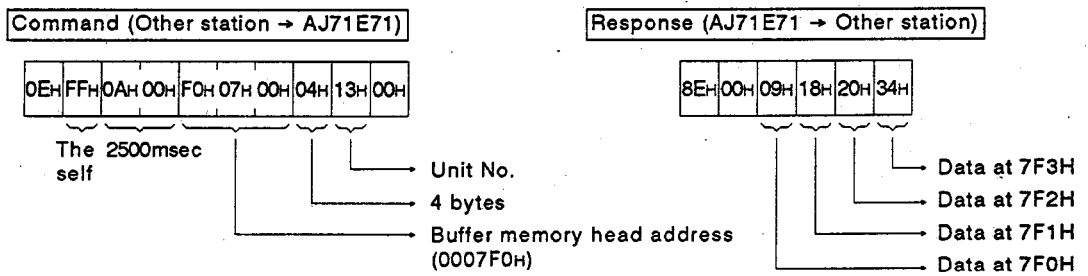

8. READING AND WRITING DATA STORED IN THE PC CPU

MELSEC-A

(2) Communications in ASCII code

Command Format

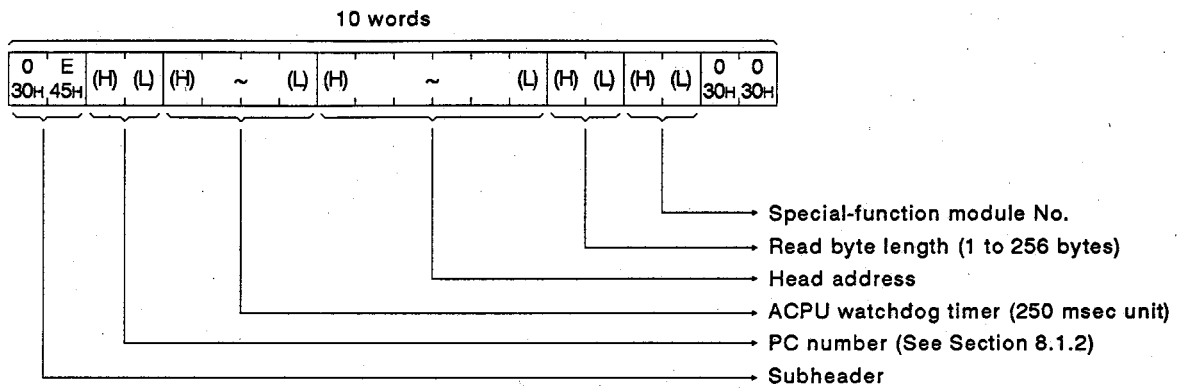

REMARK

When byte length is specified to 256 bytes, set "3030H".

Response Format

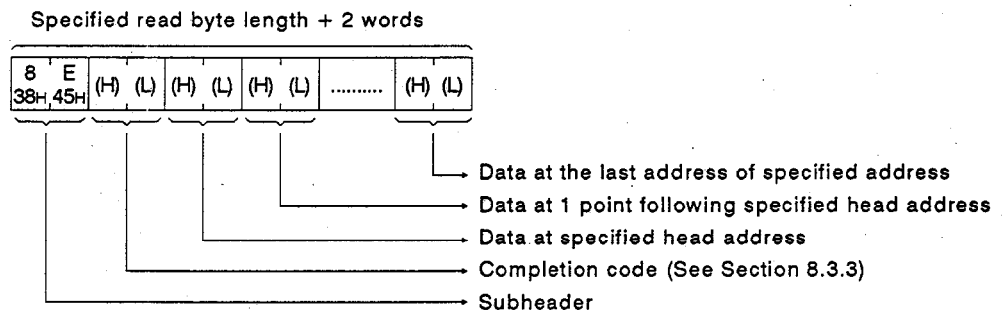

Example: When reading data of 7F0H to 7F3H of special-function modules (X and Y120 to 13F (module No. 13H)) of a same station loaded with AJ71E71

Command (Other station → AJ71E71)

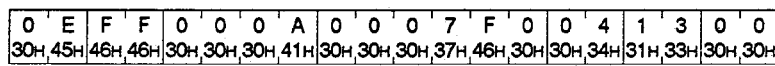

(0EH) The self 2500msec Buffer memory head address (0007F0H) 4 bytes Module No. (13H)

Response (AJ71E71 → Other station)

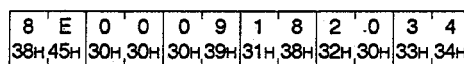

→ Data at address 7F3H
 → Data at address 7F2H
 → Data at address 7F1H
 → Data at address 7F0H

8. READING AND WRITING DATA STORED IN THE PC CPU MELSEC-A

8.6.4 Writing special-function module buffer memory

The command and response formats are as follows when data is written to the buffer memory of a special-function module:

(1) Communications in binary code

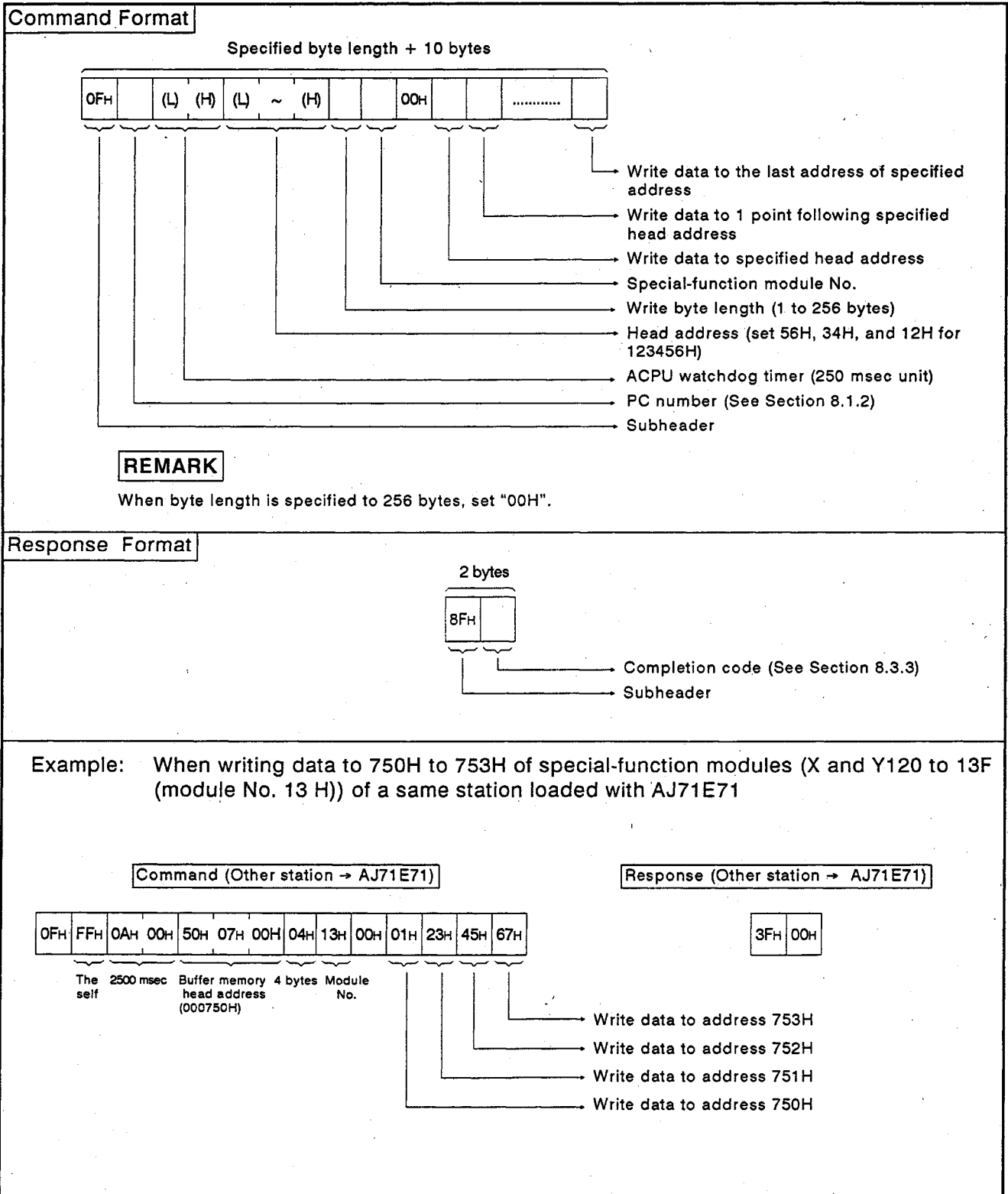

8. READING AND WRITING DATA STORED IN THE PC CPU

MELSEC-A

(2) Communications in ASCII code

Command Format

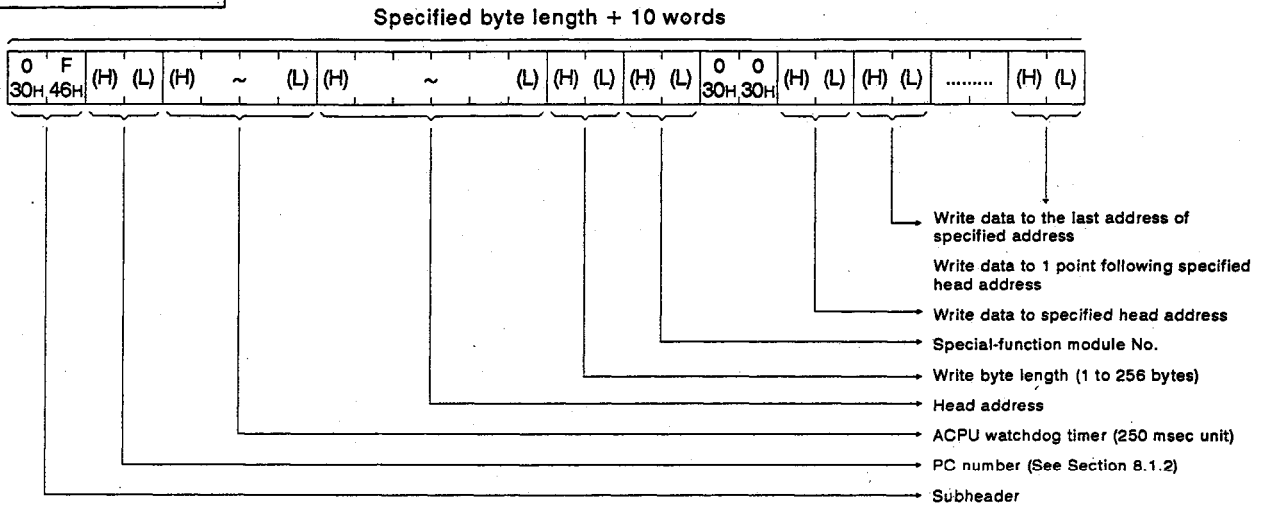

REMARK

When byte length is specified to 256 bytes, set "3030H".

Response Format

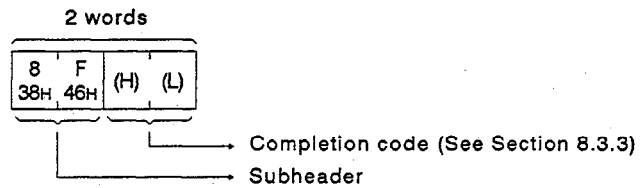

Example: When writing data to 750H to 753H of special-function modules (X and Y120 to 13F (module No. 13H)) of a same station loaded with AJ71E71

Command (Other station → AJ71E71)

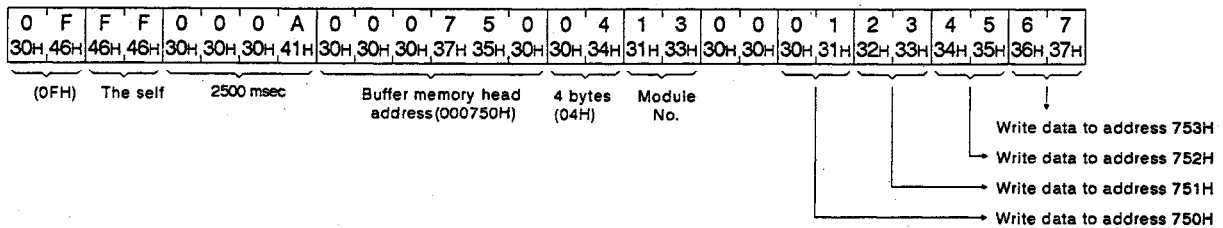

Response (AJ71E71 → Other station)

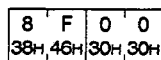

8. READING AND WRITING DATA STORED IN THE PC CPU

MELSEC-A

8.7 Command and Response Formats for the Remote RUN/STOP and CPU Model Name Read

This function is used to request a remote RUN/STOP to a PC CPU from a communicating station and also read the model name of the PC CPU that is linked with the station.

This section explains the specification contents and method and the specification example of a control protocol.

8.7.1 Function

Table 8.8 shows the functions to be used for remote RUN/STOP and reading of CPU model name.

Table 8.8 Functions

Item	Command/ Response Classifica- tion	Description	PC CPU State		
			During STOP	During RUN	
				SW22 ON	SW22 OFF
Remote RUN	13H	Requests remote RUN of PC CPU.	o	o	o
Remote STOP	14H	Requests remote STOP of PC CPU.	o	o	o
PC CPU model read mode	15H	Reads if the PC CPU is model A1N, A2N, A3N, A3H or AJ72P25/R25.	o	o	o

o : Available
x : Unavailable

POINT

Remote RUN and remote STOP are enabled only for the CPU of a communicating station.

Remote STOP cannot be done for the CPU of the self.

8. READING AND WRITING DATA STORED IN THE PC CPU MELSEC-A

8.7.2 Remote RUN/STOP

(1) Control states by remote RUN/STOP

(a) The state of a PC CPU changes according to the specification of remote RUN/STOP from other stations and setting of the RUN/STOP keyswitch on the front of the PC CPU as shown below.

		Keyswitch Setting on the PC CPU front			
		RUN	STOP	PAUSE	STEP-RUN
Specification from other node	Remote RUN	RUN	STOP	PAUSE	STEP-RUN
	Remote STOP	STOP	STOP	STOP	STOP

REMARKS

- (a) When a PC CPU is already set to a state of remote STOP through other AJ71E71s or AJ71C24
Even if remote RUN is requested through an AJ71E71 of the self, the CPU is not set to the RUN state.
- (b) The state of special relays M9016 and M9017 decides whether a data memory is cleared or not before executing remote RUN.

Special Relay		State of Data Memory
M9016	M9017	
OFF	OFF	RUN is enabled without clearing memory.
OFF	ON	Data outside a latched range set in the parameter is cleared. (X image data for link is not cleared)
ON	ON/OFF	All data are cleared, and RUN is enabled.

REMARK

Be sure to set special relays M9016 and M9017 to the reset state not to clear data memory before executing remote RUN as shown above.

POINT

After operations remote RUN/STOP control from the other station are completed, the remote data will be lost if the power supply is turned OFF or the PC CPU is reset.

8. READING AND WRITING DATA STORED IN THE PC CPU

MELSEC-A

(2). Command/response formats

When remote RUN/STOP of a PC CPU is specified in the other, the command and response formats are as follows:

(a) Communications in binary code

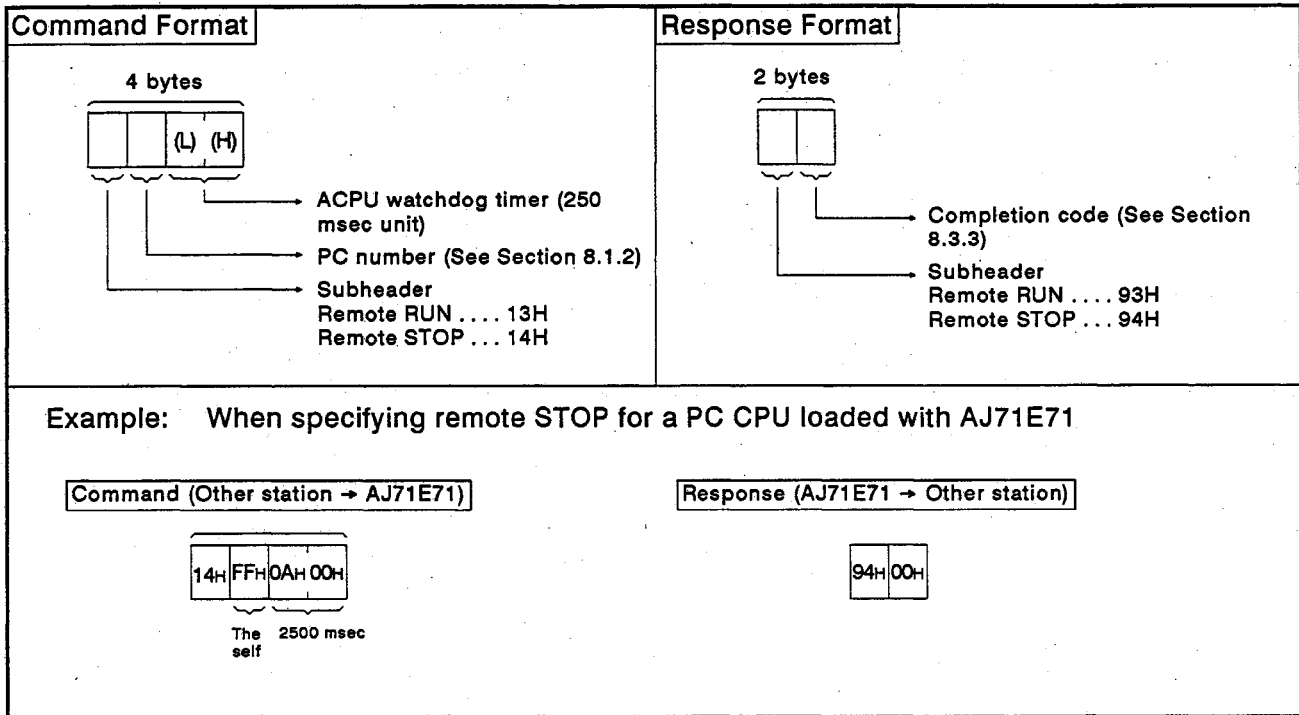

(b) Communications in ASCII code

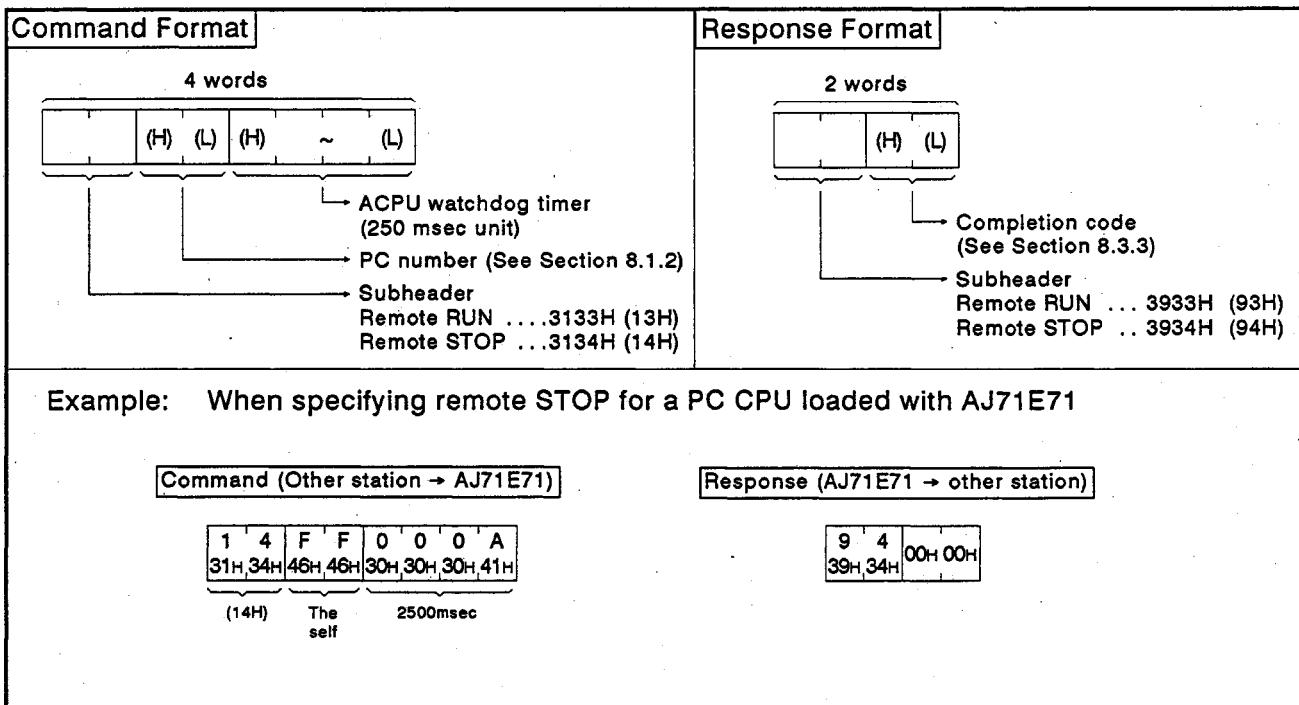

8. READING AND WRITING DATA STORED IN THE PC CPU MELSEC-A

8.7.3 Read of PC CPU model name

This function reads the model name of the PC CPU that is communicating with another through an AJ71E71.

(1) PC CPU model names and read codes

PC CPU model name	Read code (Hexadecimal)
A1CPU, A1NCPU	A1H
A2CPU-S1, A2NCPU, A2CPU, A2NCPU-S1	A2H
A3CPU, A3NCPU, A3HCPU	A3H
A3HCPU, A3MCPU	A4H
A2ACPU	92H
A2ACPU-S1	93H
A3ACPU	94H
A0J2HCPU	98H
AJ71P25/R25	ABH

8. READING AND WRITING DATA STORED IN THE PC CPU MELSEC-A

(2) Command/response formats

When the model name of a PC CPU is read from another, the command and the response formats are as follows:

(a) Communications in binary code

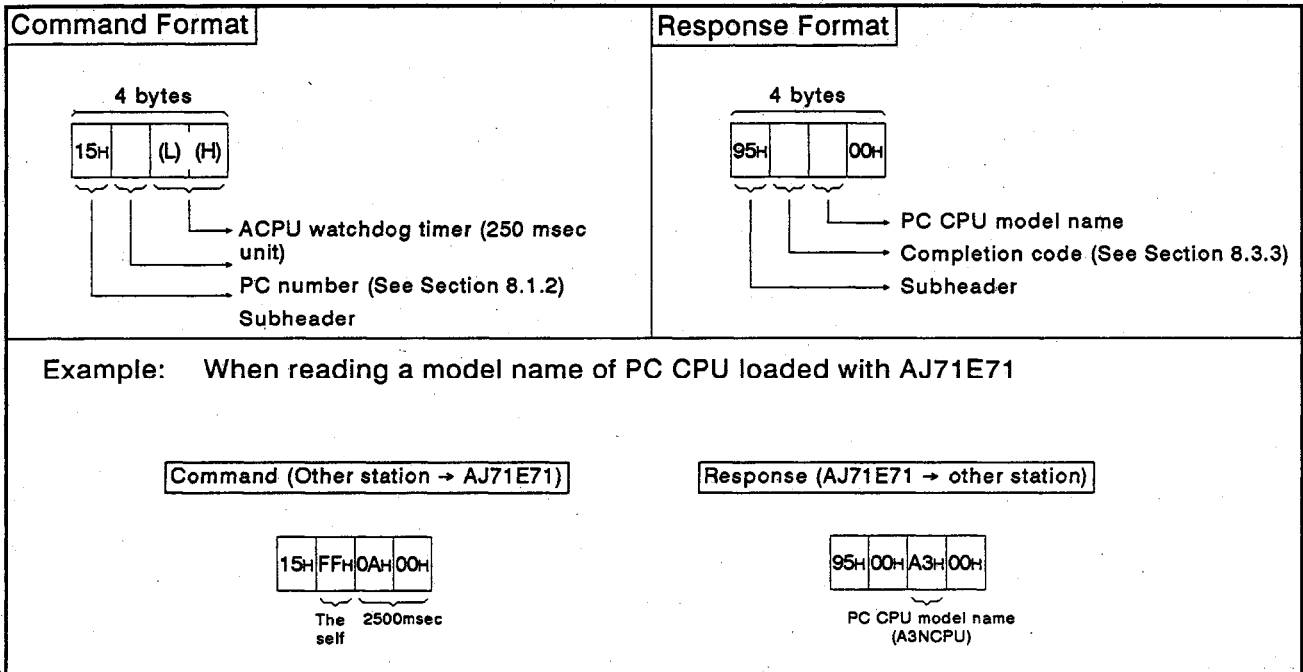

(b) Communications in ASCII code

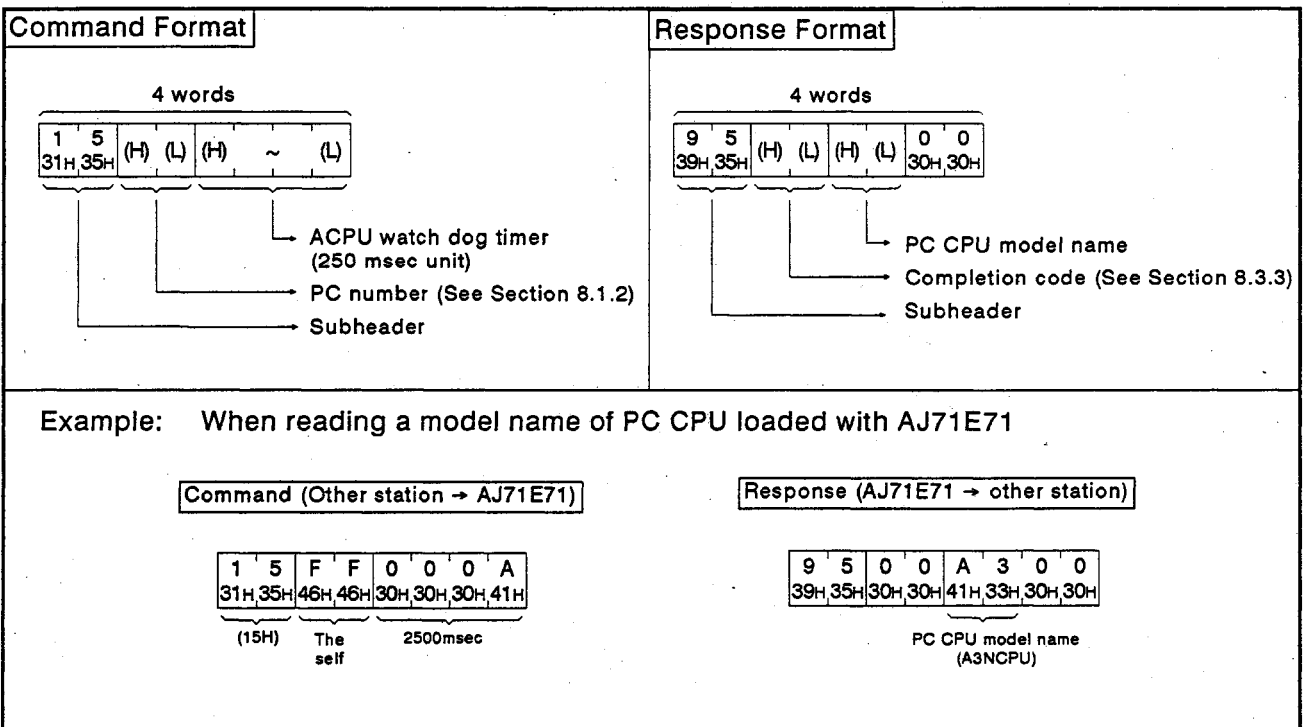

8.8 Command/Response Format for Read/Write of a Program

When another node reads and stores several kinds of programs (main subsequence program and main submicrocomputer program), parameter data and comment data from the PC CPU and when another writes a program, parameter data and comment data in a PC CPU according to a control data this function is used.

8.8.1 Precautions for read/write of a program

The following explains precautions at the time of read/write of a program:

- (1) When a program is read, read all areas of a sequence program, a microcomputer program, parameter data and comment data written by a PC CPU.

When a program is written, write all data that are read and stored in a PC CPU.

Be sure to write parameter data before writing a program. Then, execute an analysis request.

- (2) If they are not executed, while the parameter of a user memory is changed, the parameter stored in the work area of a PC CPU is not changed.

Therefore even if it is loaded with a peripheral device, and a CPU is operated, after changing a parameter, the parameter is processed in the state of set contents before changing it (contents stored in a work area).

- (3) The number of device points that can be processed in the communications at one time has been arranged for each command.

When read/write is done, divide data, and read/write of all areas.

8.8.2 Operation procedure

The operation procedure to be used for read/write of a program is as follows:

(1) Read operation

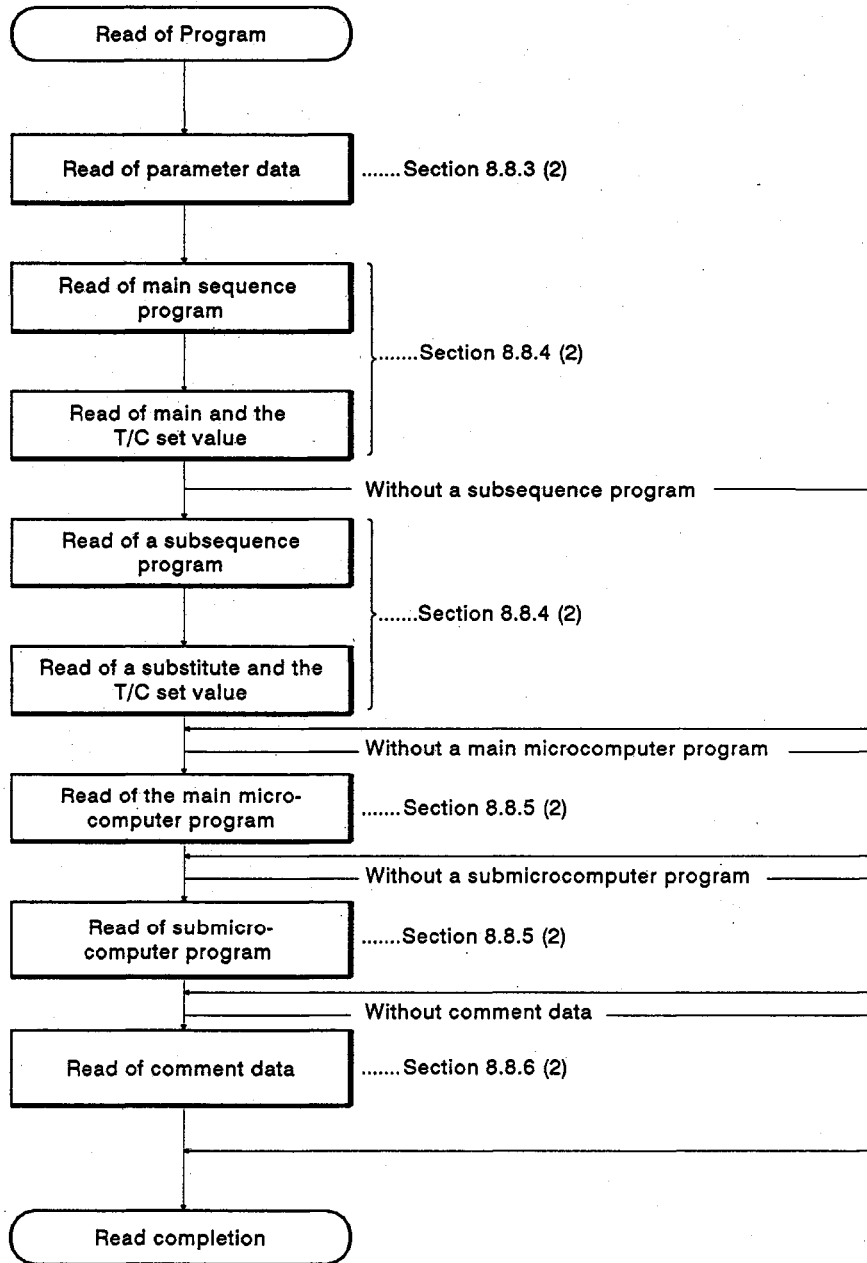

(2) Write operation

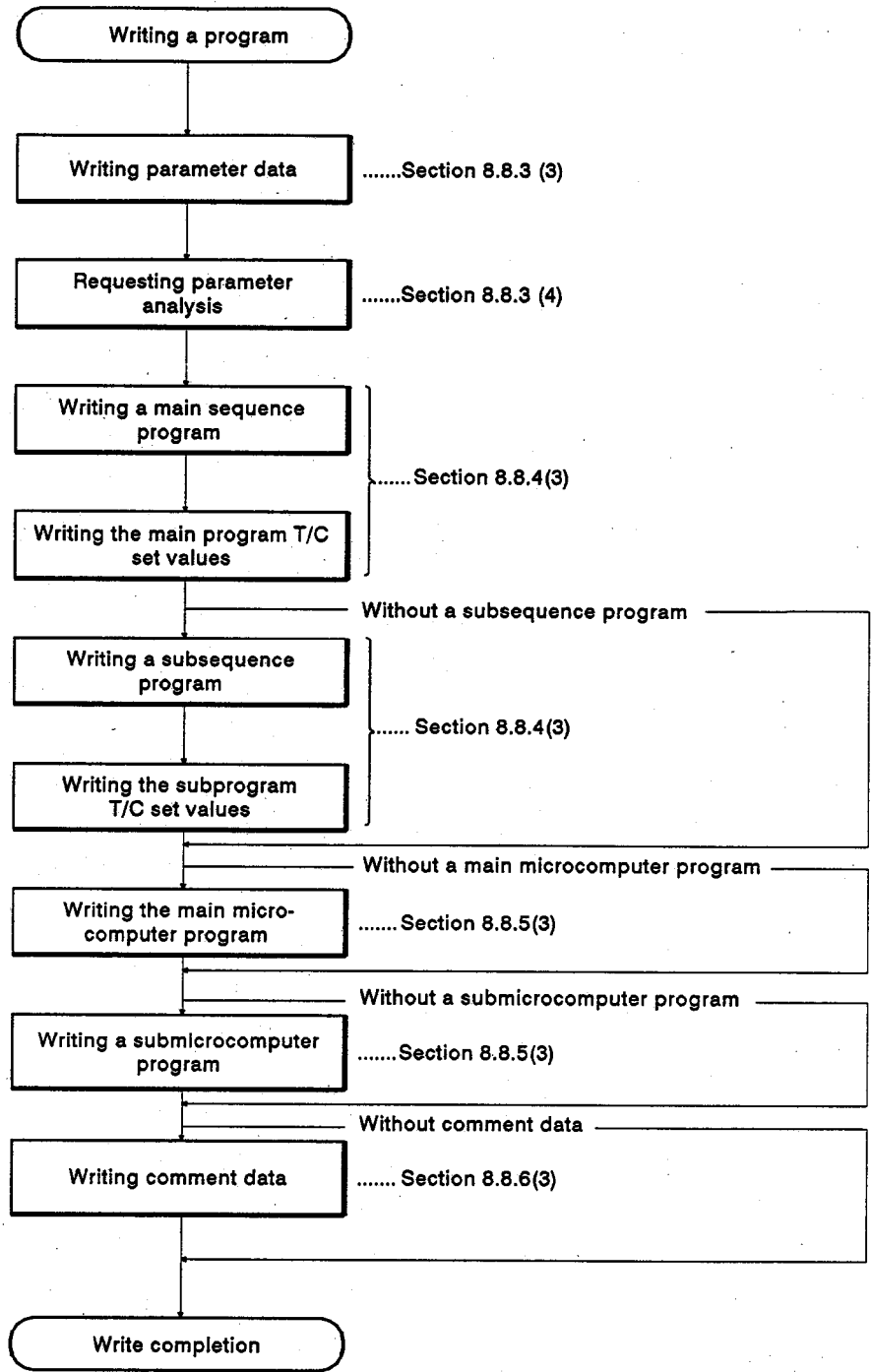

8. READING AND WRITING DATA STORED IN THE PC CPU

MELSEC-A

8.8.3 Read/write of parameter memory

When the contents of the parameter memory of a PC CPU is read, or data is written in a parameter memory. The specification contents and the method and the specification example of a control protocol are as follows:

(1) Commands and addresses

(a) Table 8.9 shows a function to be used for parameter read/write.

Table 8.9 Function

Item	Command/ Response Classifica- tion	Processing	Number of Points Processed per Communica- tion	PC CPU State		
				During STOP	During RUN	
					SW22 ON	SW22 OFF
Batch read	10H	Read parameters from PC CPU	256 bytes	o	o	o
Batch write	11H	Writes parameters to PC CPU.		o	x	x
Analysis request	12H	Causes PC CPU to acknowledge and check rewritten parameters.		o	x	x

Note : o.....Executable
x.....Unavailable

(b) Address of a parameter

The parameter memory area has 3 K byte from addresses 0H to BFFH.

When specifying example address 123H

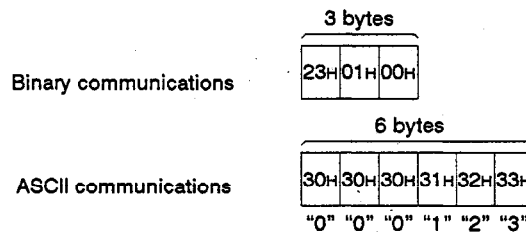

POINT

After writing all data that requires to change, change a parameter memory. And then, execute a parameter analysis request.

If it is not written, the parameter in the user memory is changed, but the parameter stored in the work area of the PC CPU is not changed.

Therefore, even if the CPU is loaded with a peripheral device and it is operated after changing the parameter, the CPU executes processing with the parameter setting before it is changed (contents stored in the work area).

8. READING AND WRITING DATA STORED IN THE PC CPU

MELSEC-A

(2) Batch read

When a parameter memory contents of a PC CPU is read, the command and response formats are as follows:

(a) Communications in binary code

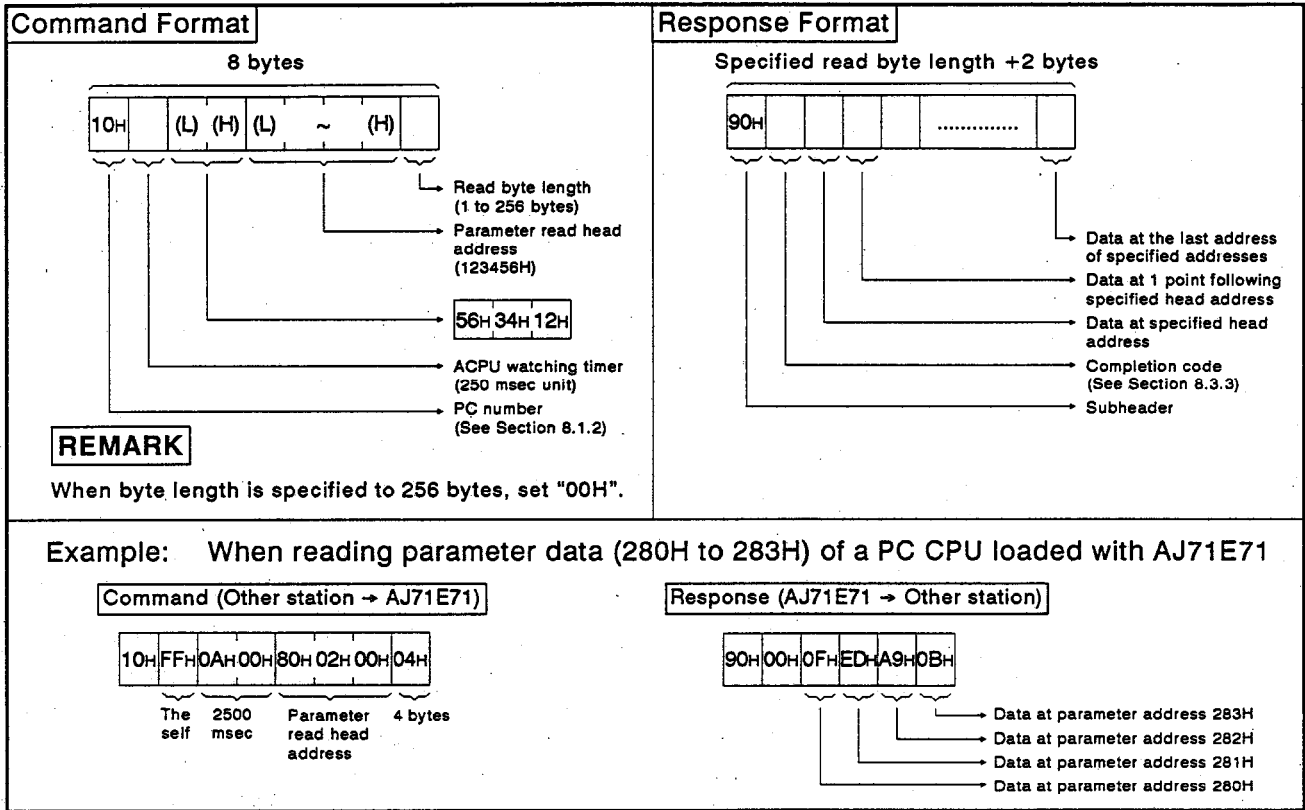

(b) Communications in ASCII code

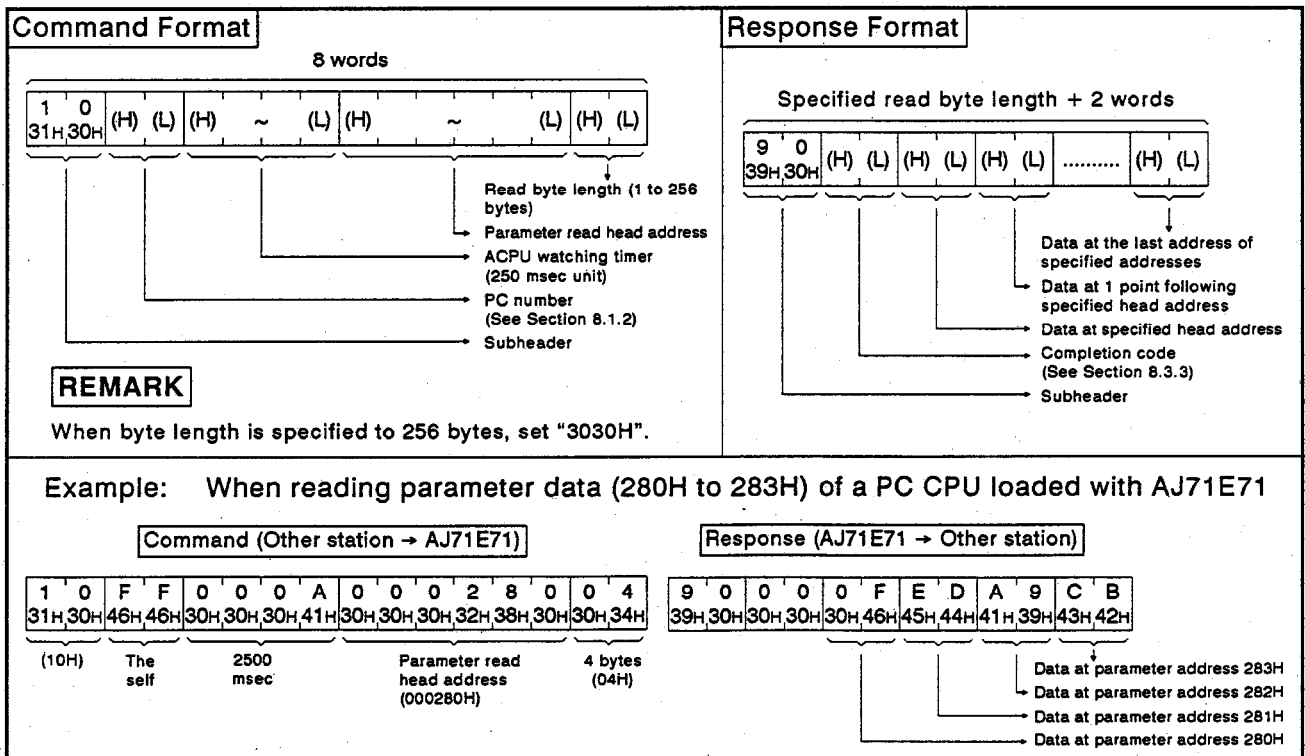

(3) Batch write

When data is written to a parameter memory contents of a PC CPU, the command and response formats are as follows:

(a) Communications in binary code

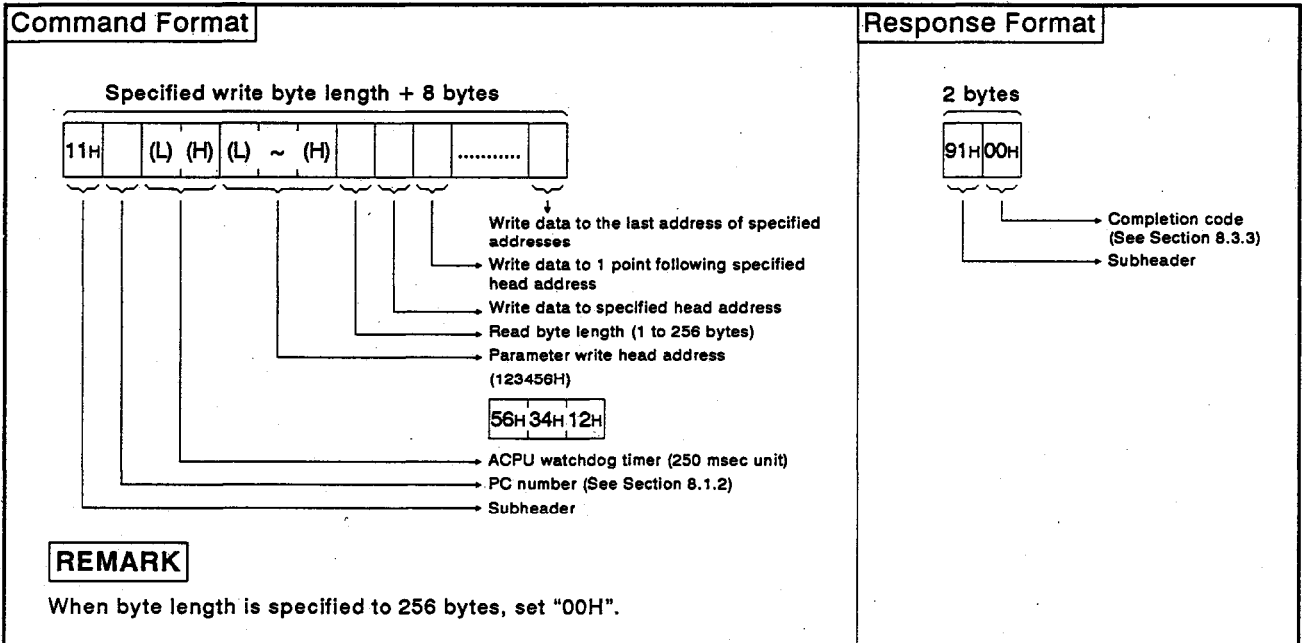

Example: When reading parameter data (285H to 288H) of a PC CPU loaded with AJ71E71

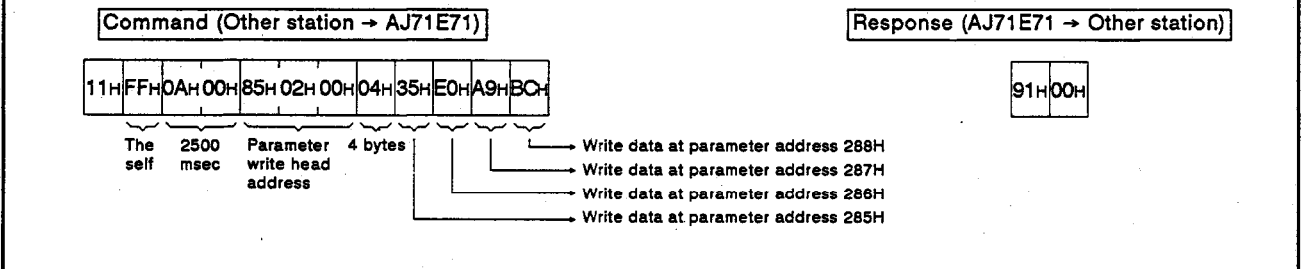

(b) Communications in ASCII code

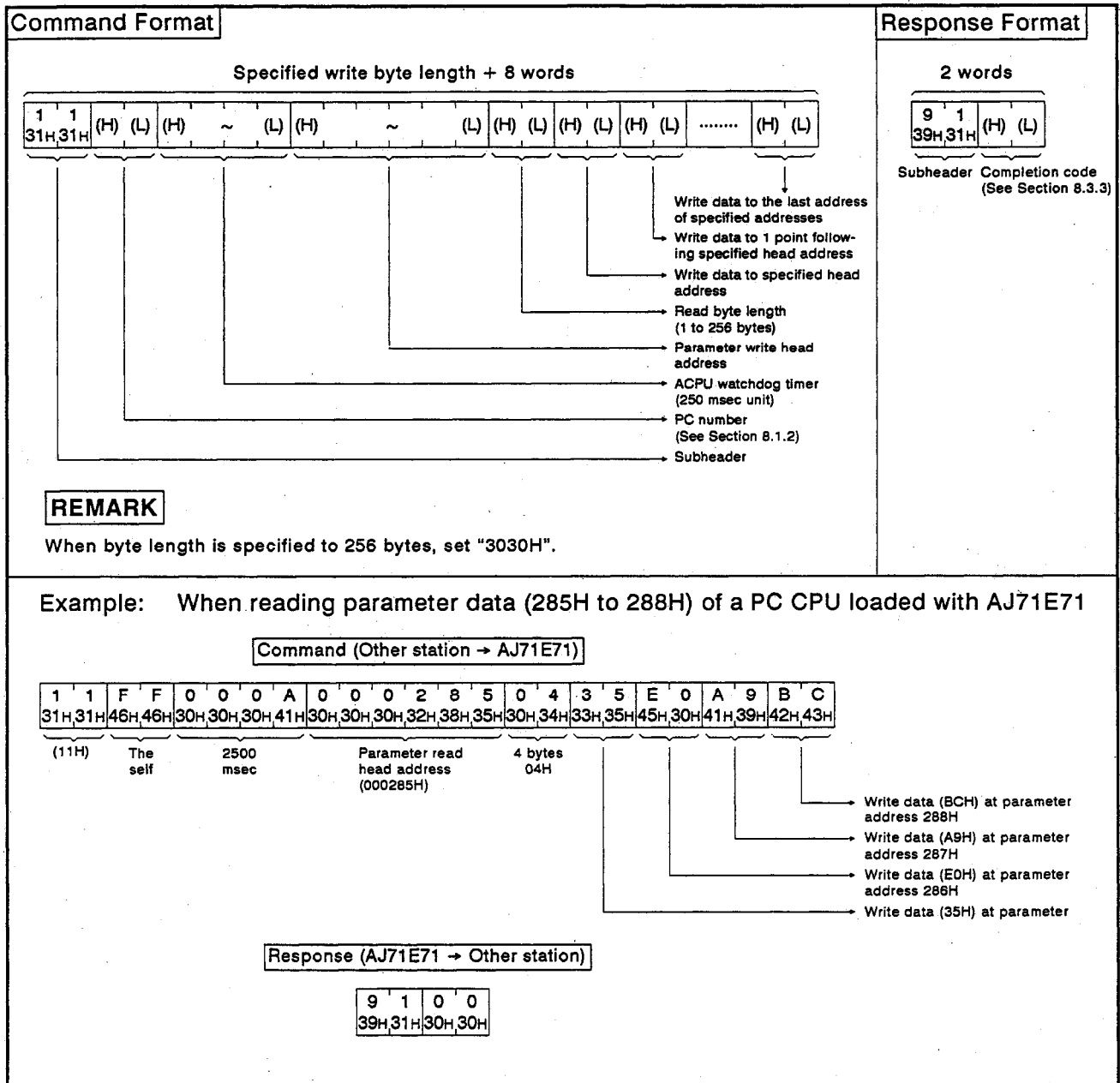

(4) Analysis request

When an analysis request of parameter data is made to a PC CPU, the command and the response formats are as follows:

When a parameter is changed, the PC CPU is made to recognize the change of parameter by making an analysis request.

If an analysis request is not executed, the PC CPU cannot operate with changed parameter.

(a) Communications in binary code

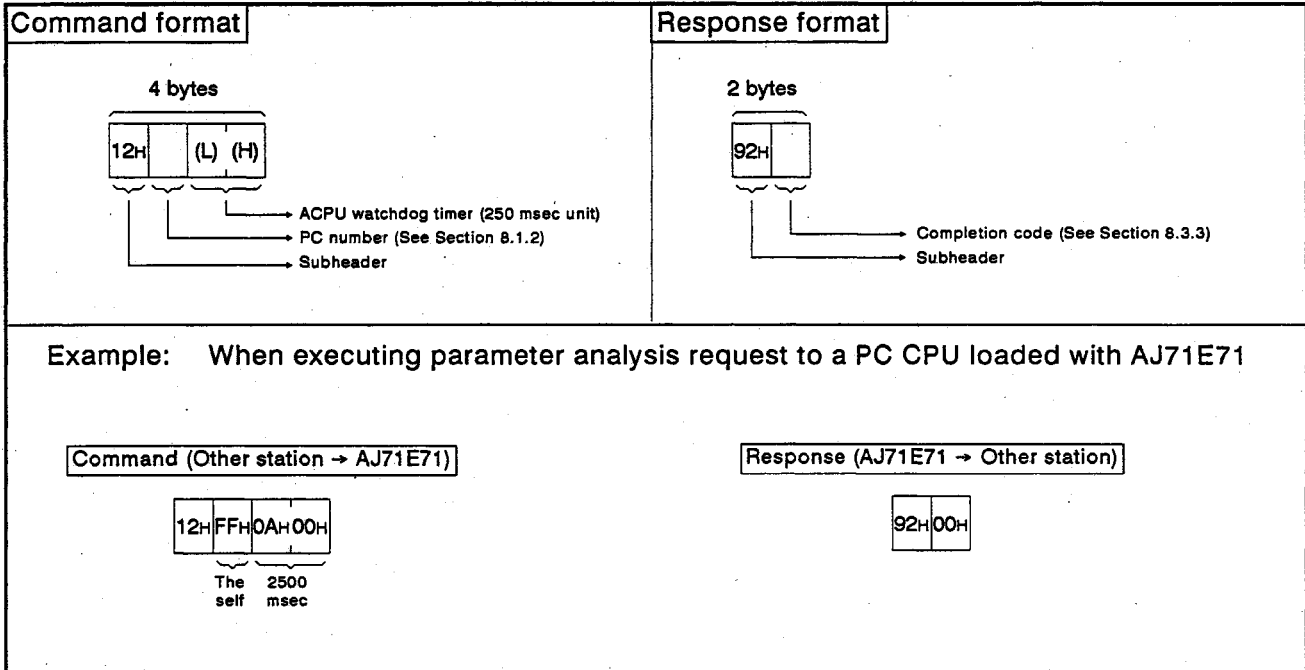

(b) Communications in ASCII code

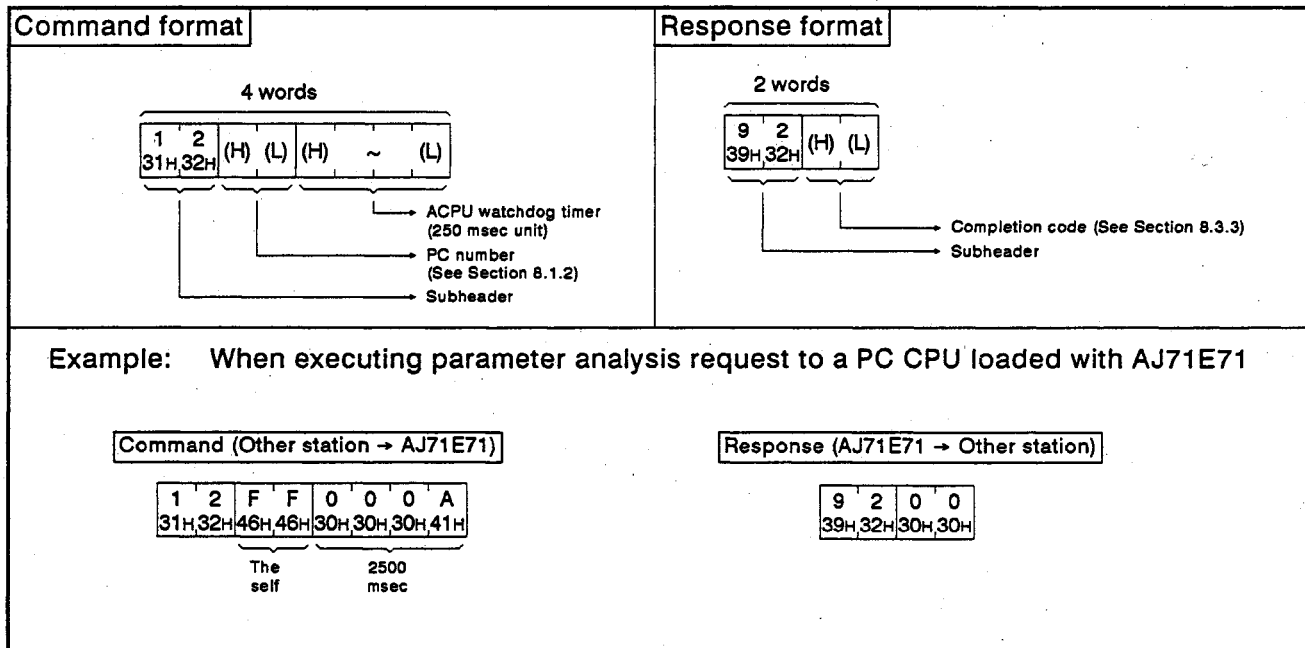

8. READING AND WRITING DATA STORED IN THE PC CPU MELSEC-A

8.8.4 Read/write of sequence programs

When the sequence program of a PC CPU is read and written, the specification contents, the method and the specification example of a protocol are as follows:

(1) Command and method of setting

(a) Table 8.10 shows the functions to be used for read/write of sequence programs.

Table 8.10 Functions

Item		Command/ Response Classification	Processing	Number of Points Processed per Com- munication	PC CPU State		
					During STOP	During RUN	
						SW22 ON	SW22 OFF
Batch read	Main	Sequence program	Reads main sequence programs.	256 steps	o	o	o
		T/C set value	Reads T/C set values used in main sequence programs.	256 points			
	Sub	Sequence program	Reads subsequence programs.	256 steps	o	o	o
		T/C set value	Reads T/C set values used in subsequence programs.	256 points			
Batch write	Main	Sequence program	Writes main sequence programs.	256 steps	o	o *	x
		T/C set value	Writes T/C set values used in main sequence programs.	256 points			
	Sub	Sequence program	Writes subsequence programs.	256 steps	o	o *	x
		T/C set value	Writes T/C set values used in subsequence programs.	256 points			

Note : o.....Executable
x.....Not executable

* Writing during a program run may execute if all the following conditions are met:

- 1) The PC CPU is A3, A3N, A3H or A3A.
- 2) The program is not the currently running a program (indicates a subprogram called by the main program, if the main program is being run).
- 3) The PC CPU special relay is in the following state:
 - i) M9050 (signal flow conversion contact).....OFF (A3CPU only)
 - ii) M9051 (CHG instruction disable).....ON

(b) Step number specification of a sequence program

Specify the step number of a sequence program in hexadecimal as shown in Table 8.11.

Table 8.11 Step Number Specification

Step number	Set value
Step 0	0000H
Step 1 to Step 30719 (30K)	0001H to 77FEH

8. READING AND WRITING DATA STORED IN THE PC CPU MELSEC-A

(c) Device number specification for read/write of the T/C set values

Set the device number for read/write of the T/C set values using the codes shown in Table 8.12.

Read/write of the T/C set values can be done within the range from T0 to T255 and from C0 to C255.

Read/write of T256 to T2047 and C256 to C1023 of A2ACPU, A2ACPU-S1, and A3ACPU cannot be done. Execute read/write of set values by using the read/write function of device memory.

Table 8.12 Specification of the T/C Set Values

Device Number	Setting Code
T0 set value	FE00H
T1 set value to T255 set value	FE01H to FEFFH
C0 set value	FF00H
C1 set value to C255 set value	FF01H to FFFFH

Calculation of designated step

Timer : $T_m = FE00H + n$

Counter : $C_m = FF00H + n$

where, $m =$ device number

$n =$ hexadecimal value of device number

(d) Contents of the T/C set values

The T/C set values are stored in hexadecimals as shown in Table 8.13.

When the T/C set values are rewritten through an AJ71E71 from an other station, specify set data shown in Table 8.13.

Examples) Setting data to rewrite K10 of T10 to K20: 0014H

Setting data to rewrite D30 of T11 to D10: 8814H

Table 8.13 T/C Set Value Data Specification

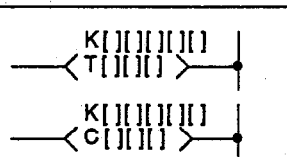
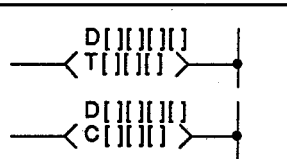
Ladder Example in Program	Setting in Program	Setting Data
	K0 K1 to K9 K10 to K32767	0000H 0001H to 0009H 000AH to 7FFFH
	D0 D1 D2 to D1023	8000H 8002H 8004H to 87FEH

Relationship between setting contents in the program and set data is as follows.

$$K_m = 0000H + n$$

$$D_m = 8000H + 2n$$

m : Device number

n : Device number converted to hexadecimal

(2) Batch read

When batch read is done for the contents (machine language) of a sequence program or the set value of timer (T) and counter (C), the command and the response formats are as follows:

(a) Communications in binary code

Command Format

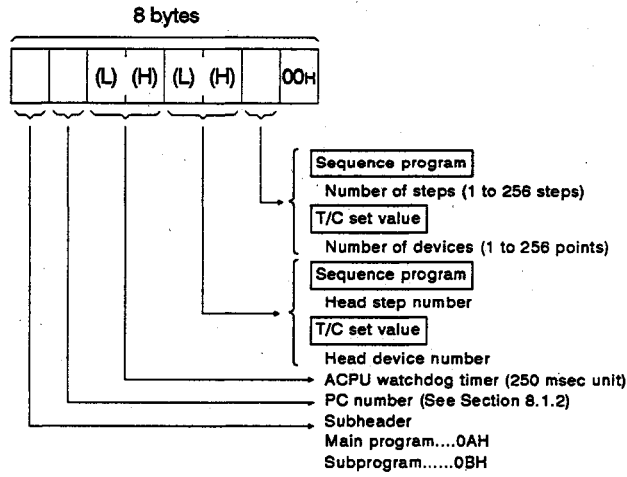

REMARK

When the number of steps or the number of devices is specified to 256 points, set "00H".

Response Format

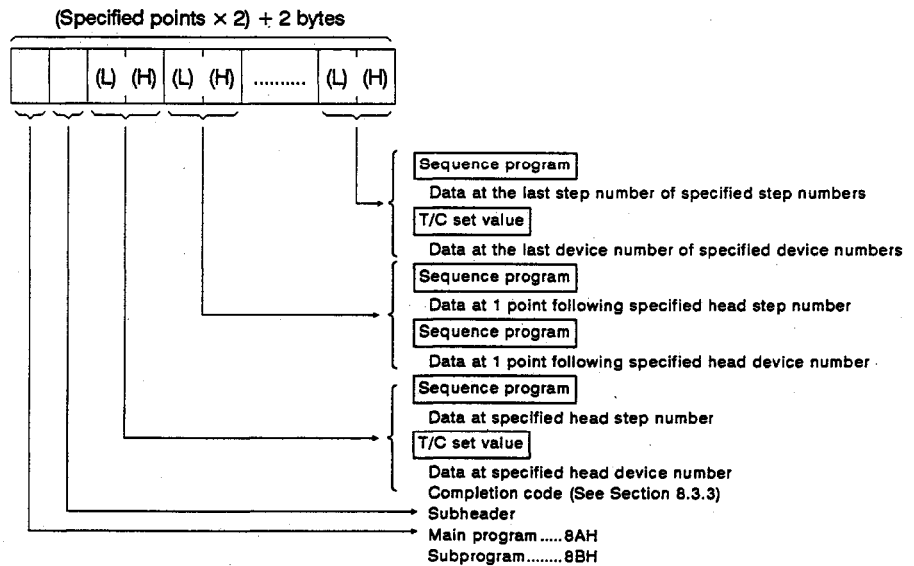

8. READING AND WRITING DATA STORED IN THE PC CPU

MELSEC-A

Example 1: When reading a main sequence program (steps 100 to 103) of a PC CPU loaded with AJ71E71

Command (Other node → AJ71E71)

0AH FFH 0AH 00H 64H 00H 04H 00H

The 2500 self msec

Step 4

Head step number (Step 100)

Response (AJ71E71 → Other node)

8AH 00H 01H 40H 02H 80H 11H 10H 05H 30H

Data (3005H) at step 103 (67H)
 Data (1011H) at step 102 (66H)
 Data (8002H) at step 101 (65H)
 Data (4001H) at step 100 (64H)

Example 2: When reading setting values of timer T8 to T11 used in a main sequence program of a PC CPU loaded with AJ71E71

Command (Other node → AJ71E71)

0AH FFH 0AH 00H 08H FEH 04H 00H

The 2500 self msec

4 points

Head device number (T8)

Response (AJ71E71 → Other node)

8AH 00H 64H 00H 23H 01H 32H 00H 6CH 89H

Set value at T11 (D182....896CH)
 Set value at T10 (K50)
 Set value at T9 (K291)
 Set value at T8 (K100)

8. READING AND WRITING DATA STORED IN THE PC CPU

MELSEC-A

(b) Communications in ASCII code

Command Format

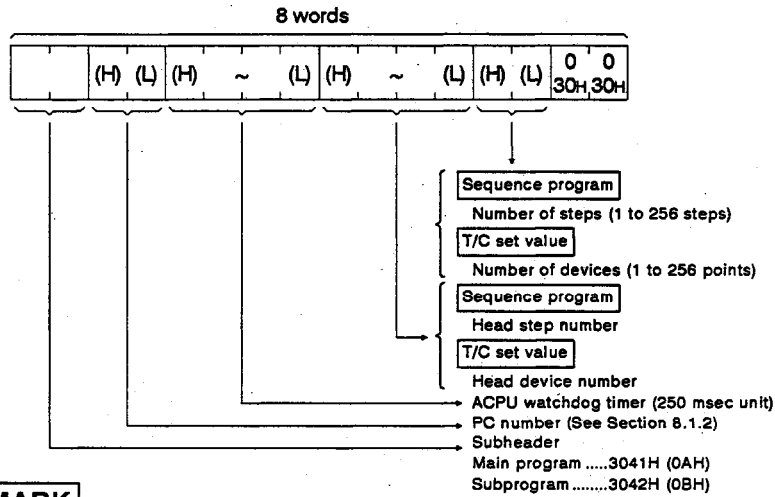

REMARK

When the number of steps or the number of devices is specified to 256 points, set "3030H".

Response Format

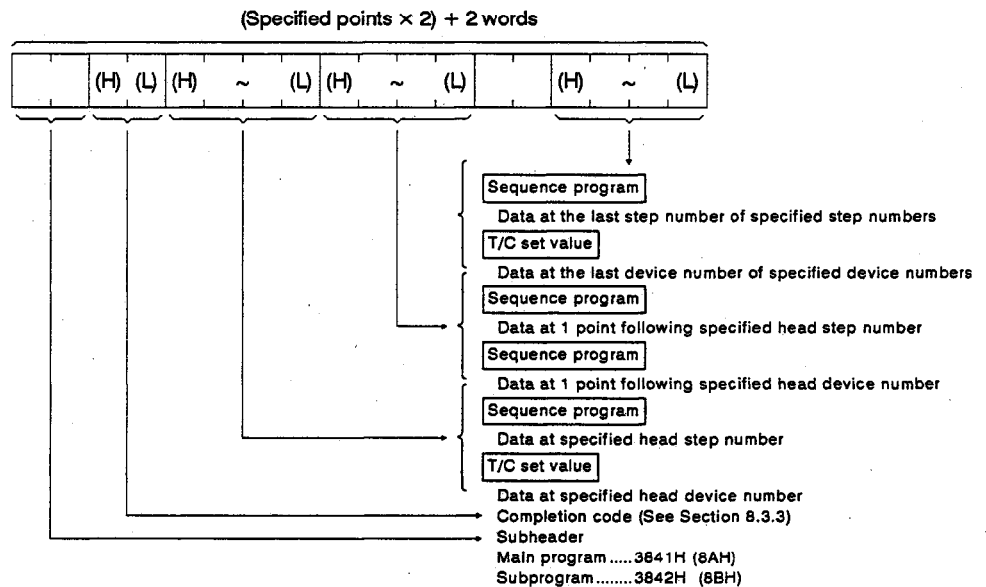

Example 1: When reading a main sequence program (steps 100 to 103) of a PC CPU loaded with AJ71E71

Command (Other node → AJ71E71)

0	A	F	F	0	0	0	A	0	0	6	4	0	4	0	0
30H	41H	46H	46H	30H	30H	30H	41H	30H	30H	36H	34H	30H	34H	30H	30H
(0AH)	The self	2500 msec	Head step number (Step 100) (0064H)	Step 4 (04H)											

Response (AJ71E71 → Other node)

8	A	0	0	4	0	0	1	8	0	0	2	1	0	1	1	3	0	0	5
38H	41H	30H	30H	34H	30H	30H	31H	38H	30H	30H	32H	31H	30H	31H	31H	33H	30H	30H	35H
Data (4001H) at step 100 (64H)				Data (8002H) at step 101 (65H)				Data (1011H) at step 102 (66H)				Data (3005H) at step 103 (67H)							

Example 2: When reading set value of timer (T8 to T11) used in a main sequence program of a PC CPU loaded with AJ71E71

Command (Other node → AJ71E71)

0	A	F	F	0	0	0	A	F	E	0	8	0	4	0	0
30H	41H	46H	46H	30H	30H	30H	41H	46H	45H	30H	38H	30H	34H	30H	30H
(0AH)	The self	2500 msec	Head device number (T8) (FE08H)	Step 4 (04H)											

Response (AJ71E71 → Other node)

8	A	0	0	0	0	6	4	0	1	2	3	0	0	3	2	8	9	6	C
38H	41H	30H	30H	30H	30H	36H	34H	30H	31H	32H	33H	30H	30H	33H	32H	38H	39H	36H	43H
Set value at T8 (0064H.....K100)				Set value at T9 (0123H.....K291)				Set value at T10 (0032H.....K50)				Set value at T11 (896CH.....D182)							

(3) Batch write

When batch write is executed for the contents (machine language) of a sequence program or the set value of timer (T) and counter (C), the command and the response formats are as follows:

(a) Communications in binary code

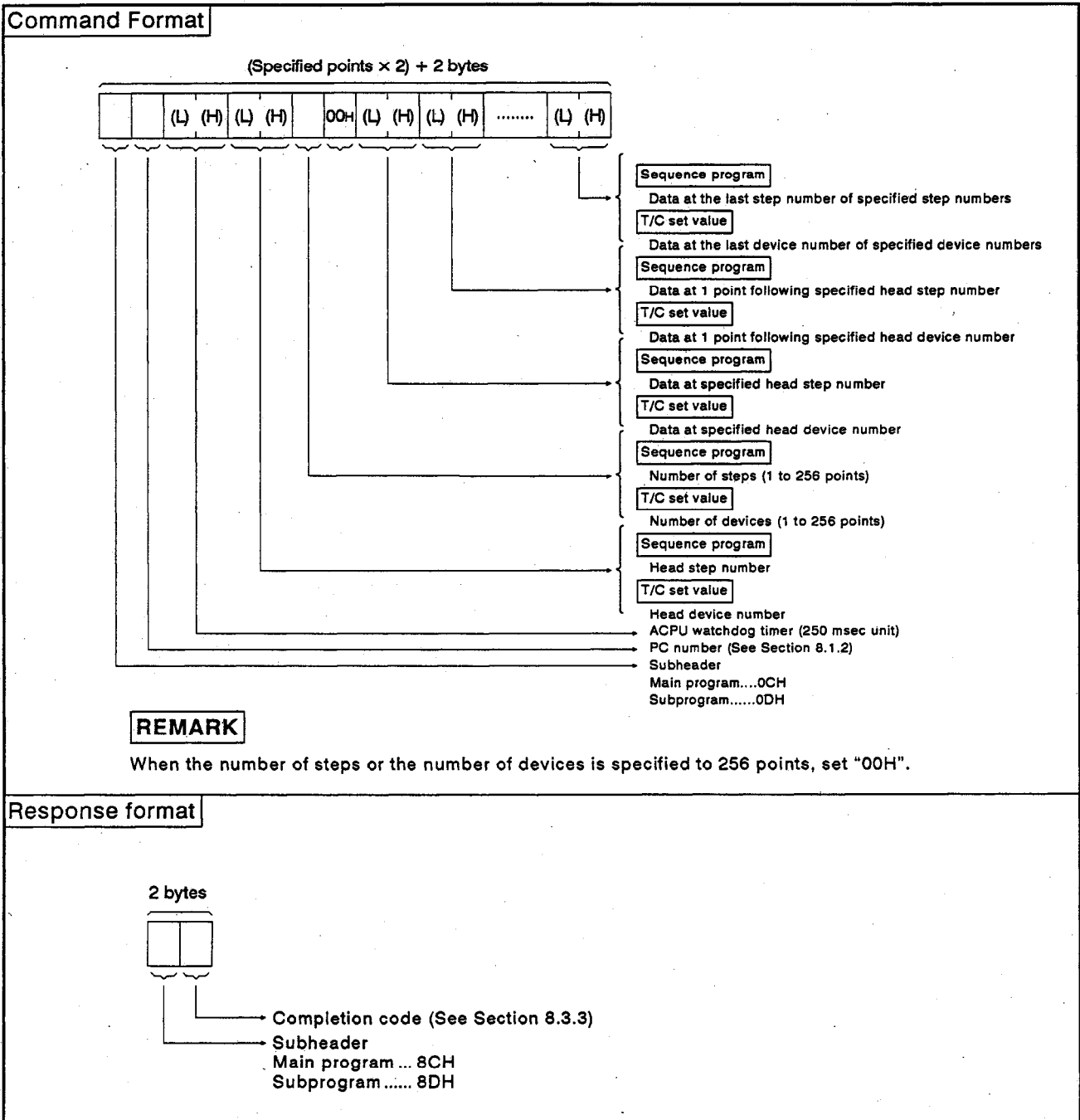

8. READING AND WRITING DATA STORED IN THE PC CPU

MELSEC-A

Example 1: When writing a main sequence program (steps 120 to 123) to a PC CPU loaded with AJ71E71

Command (Other node → AJ71E71)

0CH FFH 0AH 00H 78H 00H 04H 00H 55H 10H FAH 40H 05H 2AH A8H 70H

The 2500 self msec

Step 4

Head step number (Step 120) (0078H)

- Write data (70A8H) to step 123
- Write data (2A05H) to step 122
- Write data (40FAH) to step 121
- Write data (1055H) to step 120

Response (AJ71E71 → Other node)

8CH 00H

Example 2: When changing set value of timer (T15 to T18) used in a main sequence program of a PC CPU loaded with AJ71E71

Command (Other node → AJ71E71)

0CH FFH 0AH 00H 0FH FEH 04H 00H 64H 00H 32H 00H 08H 00H 0AH 88H

The 2500 self msec

4 points

Head device number (T15 ... FE0FH)

- Set value at T18 D5 (880AH)
- Set value at T17 200 (00C8H)
- Set value at T16 50 (0032H)
- Set value at T15 100 (0064H)

Response (AJ71E71 → Other node)

BCH 00H

8. READING AND WRITING DATA STORED IN THE PC CPU MELSEC-A

(b) Communications in ASCII code

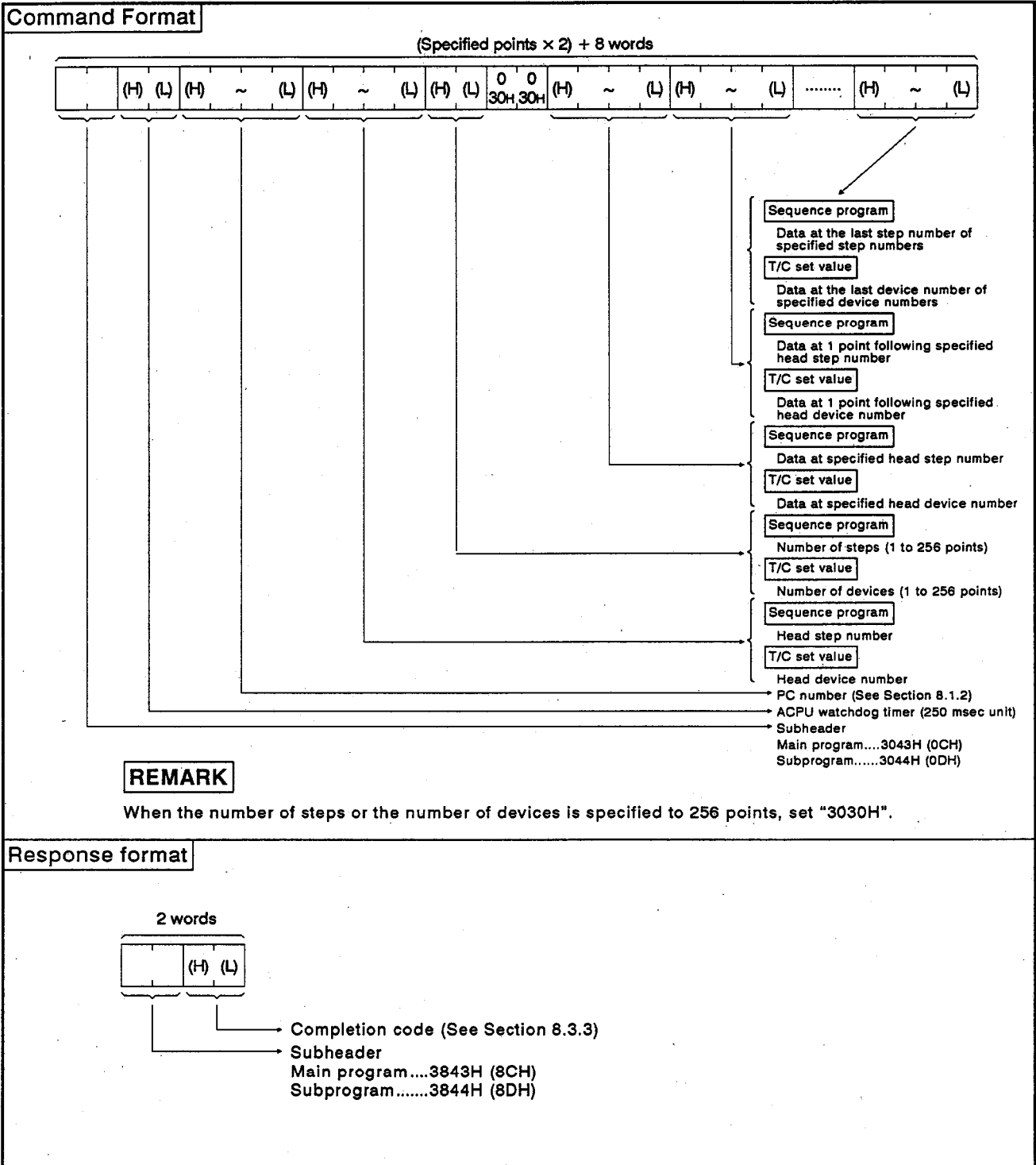

8. READING AND WRITING DATA STORED IN THE PC CPU

MELSEC-A

Example 1: When writing a main sequence program (steps 120 to 123) to a PC CPU loaded with AJ71E71

Command (Other node → AJ71E71)

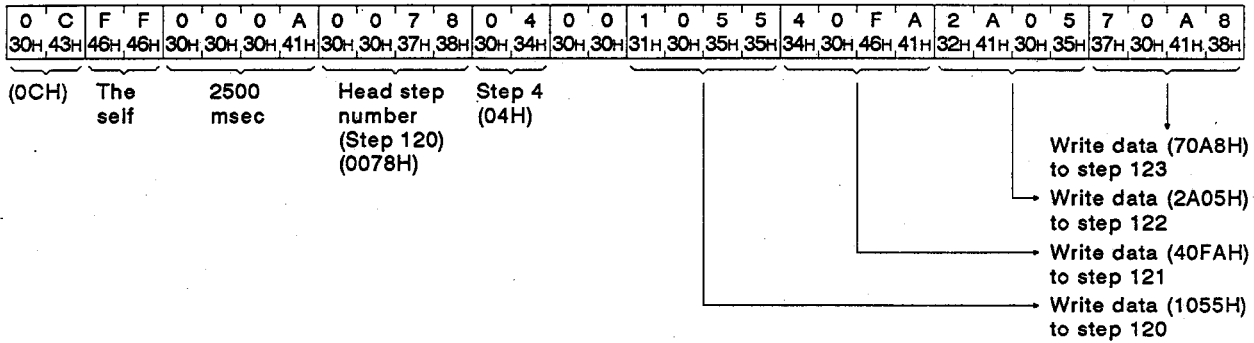

Response (AJ71E71 → Other node)

8	C	0	0
38H	43H	30H	30H

Example 2: When changing set value of timer (T15 to T18) used in a main sequence program of a PC CPU loaded with AJ71E71

Command (Other node → AJ71E71)

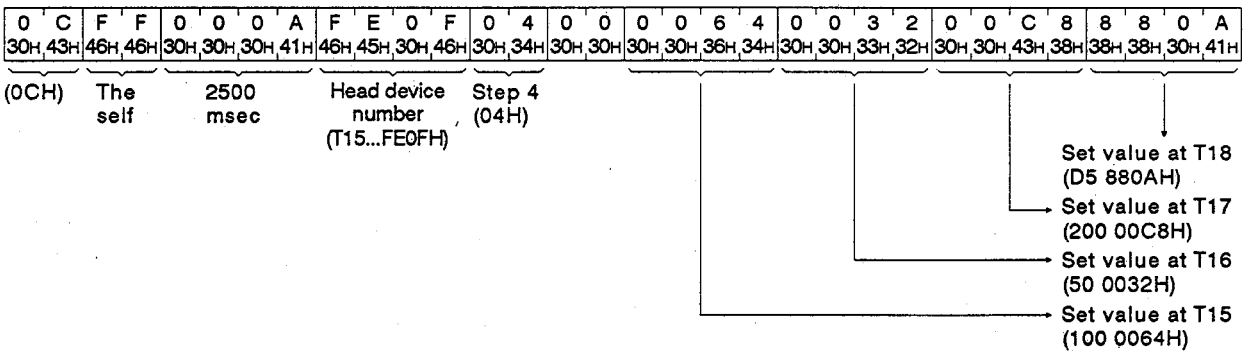

Response (AJ71E71 → Other node)

8	C	0	0
38H	43H	30H	30H

8. READING AND WRITING DATA STORED IN THE PC CPU

MELSEC-A

8.8.5 Read/write of a microcomputer program

The following explains the specification contents and method and the specification example of a protocol when the microcomputer program of a PC CPU is read and written:

(1) Command and address

The command/response classification and the program addresses are as follows when read/write of a microcomputer program is done:

(a) Table 8.14 shows the functions for the read/write of a microcomputer program.

Table 8.14 Functions

Item		Command/Response Classification	Processing	Number of Points Processed per Communication	State of PC CPU		
					During STOP	During RUN	
						SW22 ON	SW22 OFF
Batch read	Main	1EH	Reads main microcomputer programs.	256 bytes	o	o	o
	Sub	1FH	Reads submicrocomputer programs.		o	o	o
Batch write	Main	20H	Writes main microcomputer programs.		o	o*	x
	Sub	21H	Writes submicrocomputer programs.				

Note : o.....Executable
x.....Not executable

* Writing during a program run may be executed if all the following conditions are met:

- 1) The PC CPU is A3, A3N, or A3H.
- 2) The program is not a currently running program (indicates a subprogram called by the main program, if the main program is running).
- 3) The PC CPU special relay is in the following state:
M9050 signal flow conversion contact : OFF (A3CPU only)
M9051 (CHG instruction disable) : ON

(b) Microcomputer program address

1) The address ranges which can be specified in each CPU are as shown in the following table:

CPU Model Name	Microcomputer Program Capacity	Microcomputer Program Address
A1CPU, A1NCPU	Max. 10k bytes	000H to 27FFH
A2CPU (S1), A2NCPU (S1)	Max. 26k bytes	000H to 67FFH
A3CPU, A3NCPU, A3HCPU	Main/Sub, Max. 58 byte	0000H to E7FEH

2) When the sum of a head address and the number of bytes is larger than microcomputer program capacity, an error (completion code 57H) occurs.

8. READING AND WRITING DATA STORED IN THE PC CPU

MELSEC-A

(2) Batch read

The command and the response formats are as follows when batch read of the contents of a microcomputer program is done:

(a) Communications in binary code

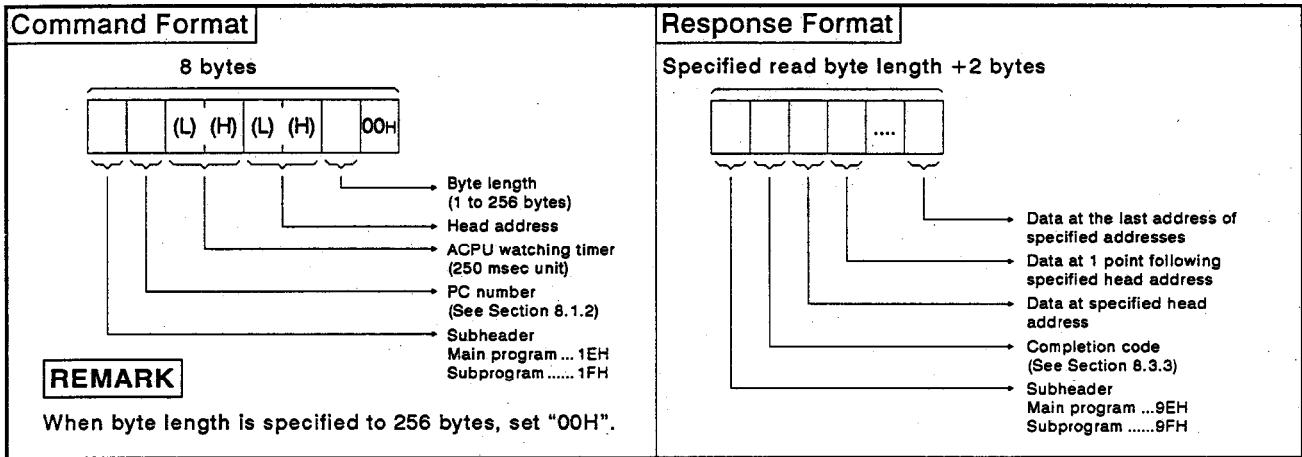

Example: When reading main microcomputer program (78H to 7BH) of a PC CPU loaded with AJ71E71

Command (Other node → AJ71E71)

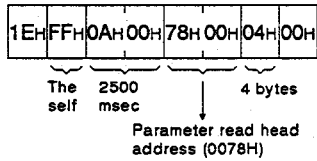

Response (AJ71E71 → Other node)

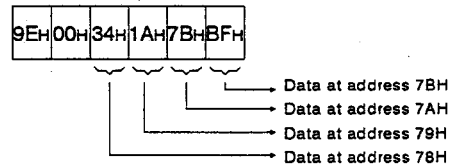

(b) Communications in ASCII code

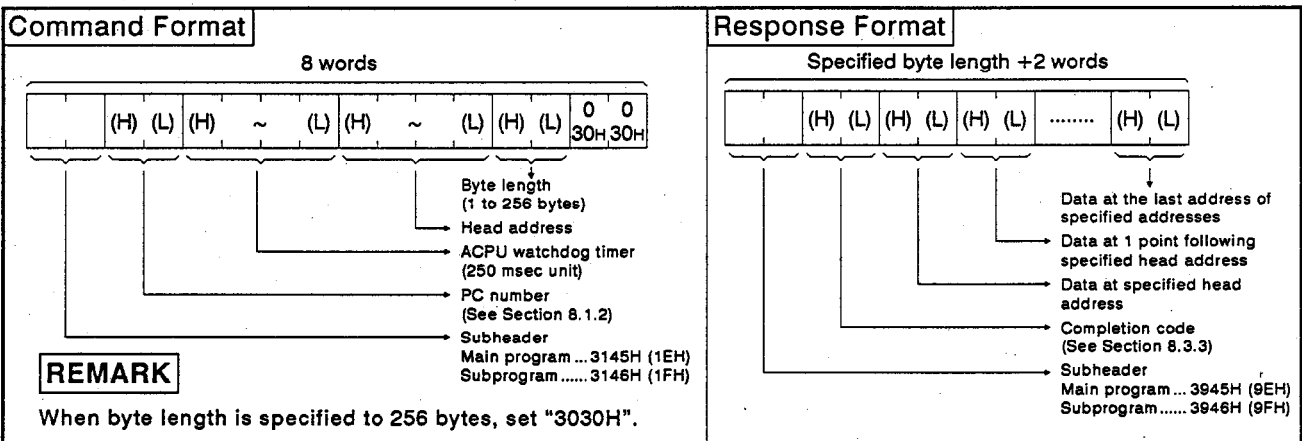

Example: When reading main microcomputer program (78H to 7BH) of a PC CPU loaded with AJ71E71

Command (Other node → AJ71E71)

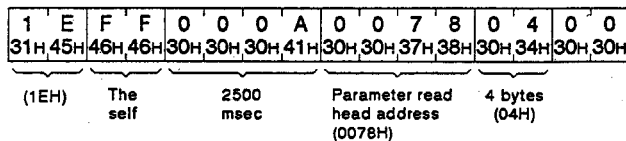

Response (AJ71E71 → Other node)

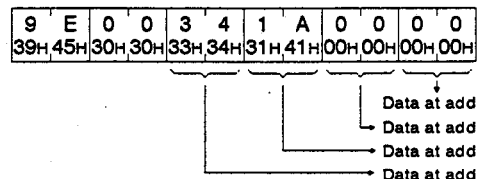

(3) Batch write

The command and response formats are as follows when the batch write of contents of microcomputer program is done:

(a) Communications in binary code

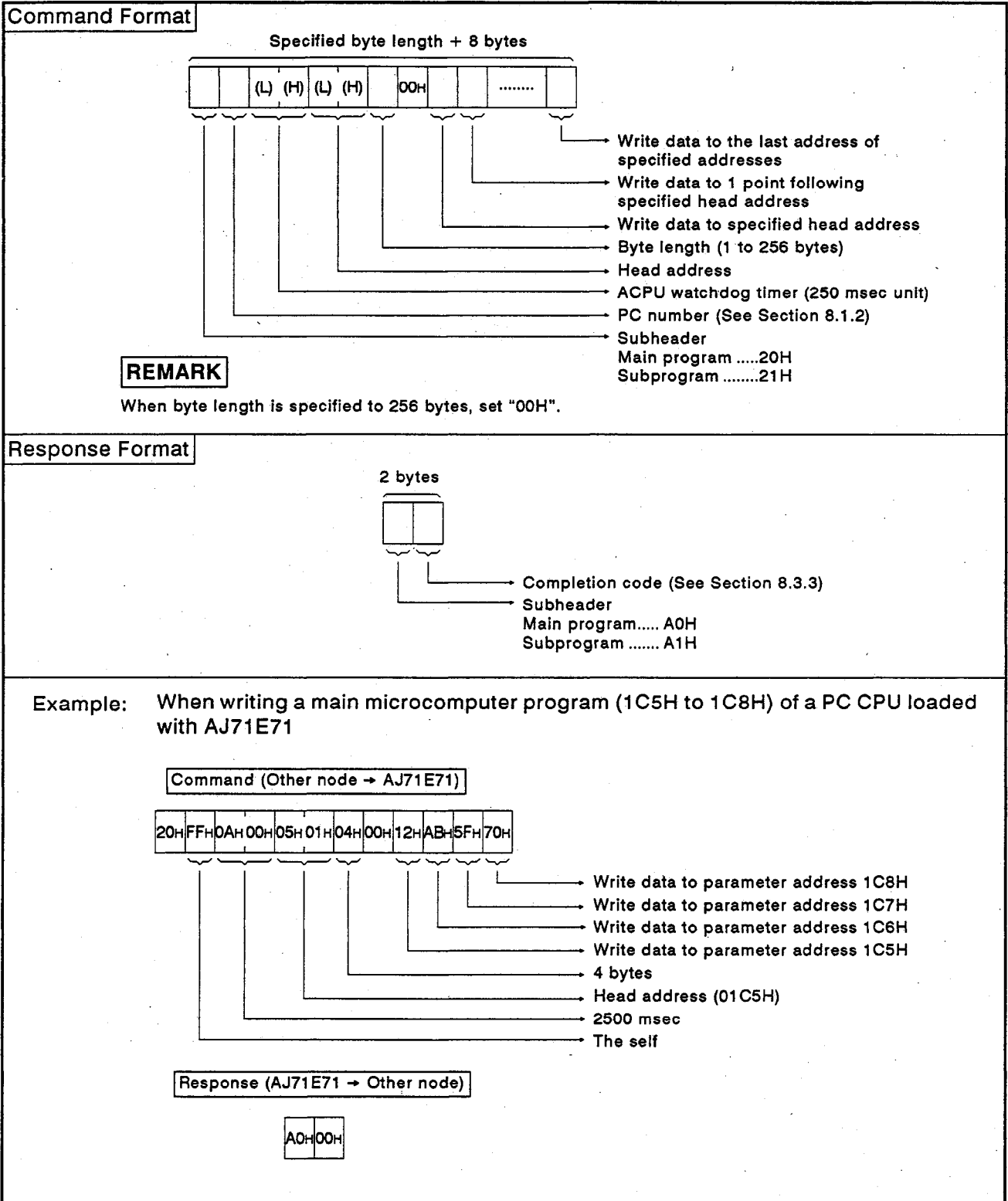

8. READING AND WRITING DATA STORED IN THE PC CPU

MELSEC-A

(b) Communications in ASCII code

Command Format

Specified byte length + 8 words

	(H)	(L)	(H)	~	(L)	(H)	~	(L)	(H)	(L)	0	0	(H)	(L)	(H)	(L)	(H)	(L)
												30H	30H						

Write data to the last address of specified addresses

Write data to 1 point following specified head address

Write data to specified head address

Byte length (1 to 256 bytes)

Head address

ACPU watchdog timer (250 msec unit)

PC number (See Section 8.1.2)

Subheader

Main program..... 3230H (20H)

Subprogram 3231H (21H)

REMARK

When byte length is specified to 256 bytes, set "3030H".

Response Format

2 words

	(H)	(L)
--	-----	-----

Completion code (See Section 8.3.3)

Subheader

Main program..... 4130H (A0H)

Subprogram 4131H (A1H)

Example: When writing a main microcomputer program (1C5H to 1C8H) of a PC CPU loaded with AJ71E71

Command (Other node → AJ71E71)

2	0	F	F	0	0	0	A	0	1	C	5	0	4	0	0	1	2	A	B	5	F	7	C
32H	30H	46H	46H	30H	30H	30H	41H	30H	31H	43H	35H	30H	34H	30H	30H	31H	32H	41H	42H	35H	46H	37H	43H

(20H) The 2500 Head address 4 bytes

 self msec (01C5H)

Write data to address 1C8H

Write data to address 1C7H

Write data to address 1C6H

Write data to address 1C5H

Response (AJ71E71 → Other node)

A	0	0	0
41H	30H	30H	30H

8. READING AND WRITING DATA STORED IN THE PC CPU

MELSEC-A

8.8.6 Read/write of comment

The following explains the specification contents and method and the specification example of a protocol when the microcomputer program of a PC CPU is read and is written:

(1) Commands and addresses

The command/response classification and the program addresses are as follows when read/write of comment data is done:

(a) Table 8.15 shows the functions for the read/write of comment data.

Table 8.15 Functions

Item	Command/ Response Classifica- tion	Processing	Number of Points Processed per Communica- tion	State of PC CPU		
				During STOP	During RUN	
					SW22 ON	SW22 OFF
Batch read	1CH	Reads from comment data.	256 bytes	o	o	o
Batch write	1DH	Writes to comment data.		o	o	x

Note : o.....Executable
x.....Not executable

(b) Comment memory addresses

The comment data storage area is managed by the relative address which begins with the head address of 00H.

For example, when the comment capacity of parameter is 2k bytes, the range from 00H to 7FFH can be specified for the head address.

1) The comment memory can be set up to 64k bytes.

The address range of comment data is fixed according to the set capacity of parameter.

2) Specify a comment memory address in hexadecimal.

3) When the sum of a head address and the number of bytes is larger than comment memory capacity, an error (completion code 57H) occurs.

POINT

Comment data cannot be read or written by setting a specific device and device number.

Start reading or writing beginning with address 0H.

The area to store comment data is managed using relative addresses from the head address 0H.

(2) Batch read

The command and the response formats are as follows when batch read of comment memory is done:

(a) Communications in binary code

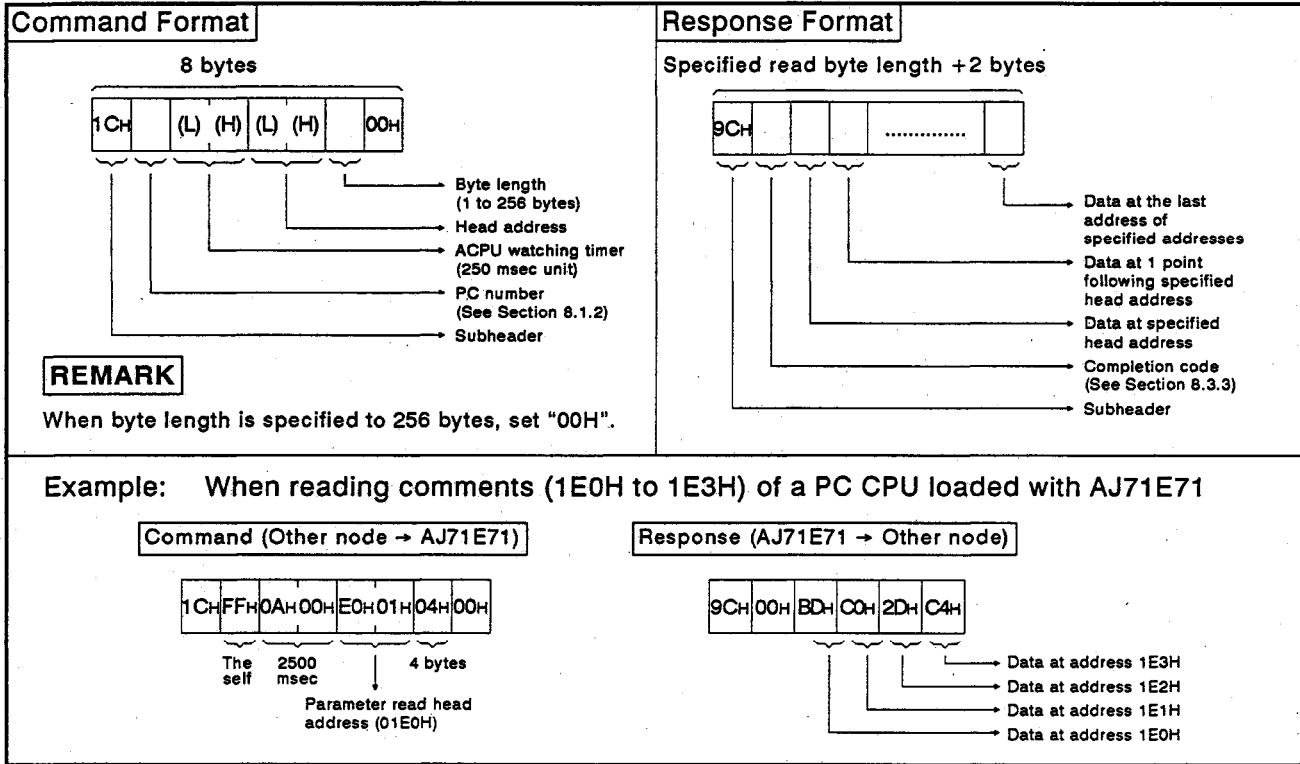

(b) Communications in ASCII code

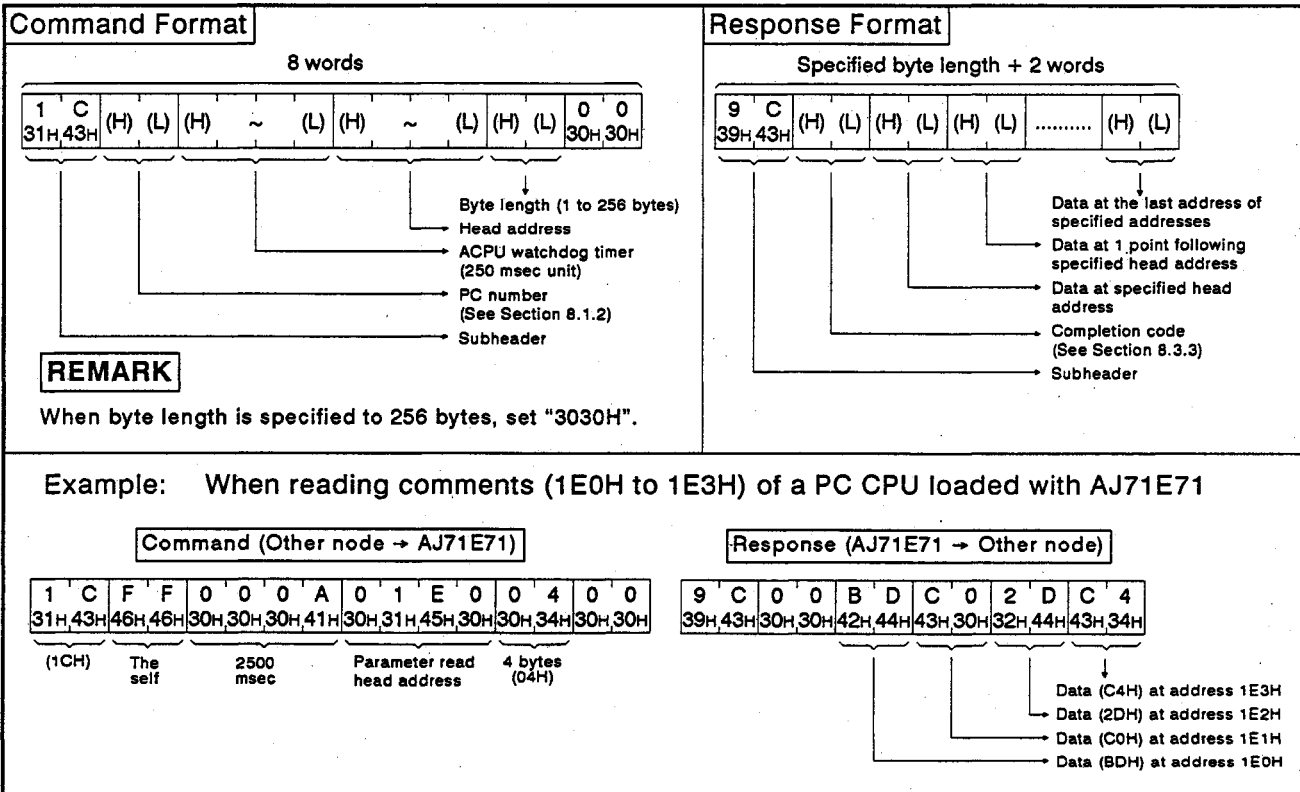

8. READING AND WRITING DATA STORED IN THE PC CPU MELSEC-A

(3) Batch write

The command and response formats are as follows when the batch write of comment memory is done:

(a) Communications in binary code

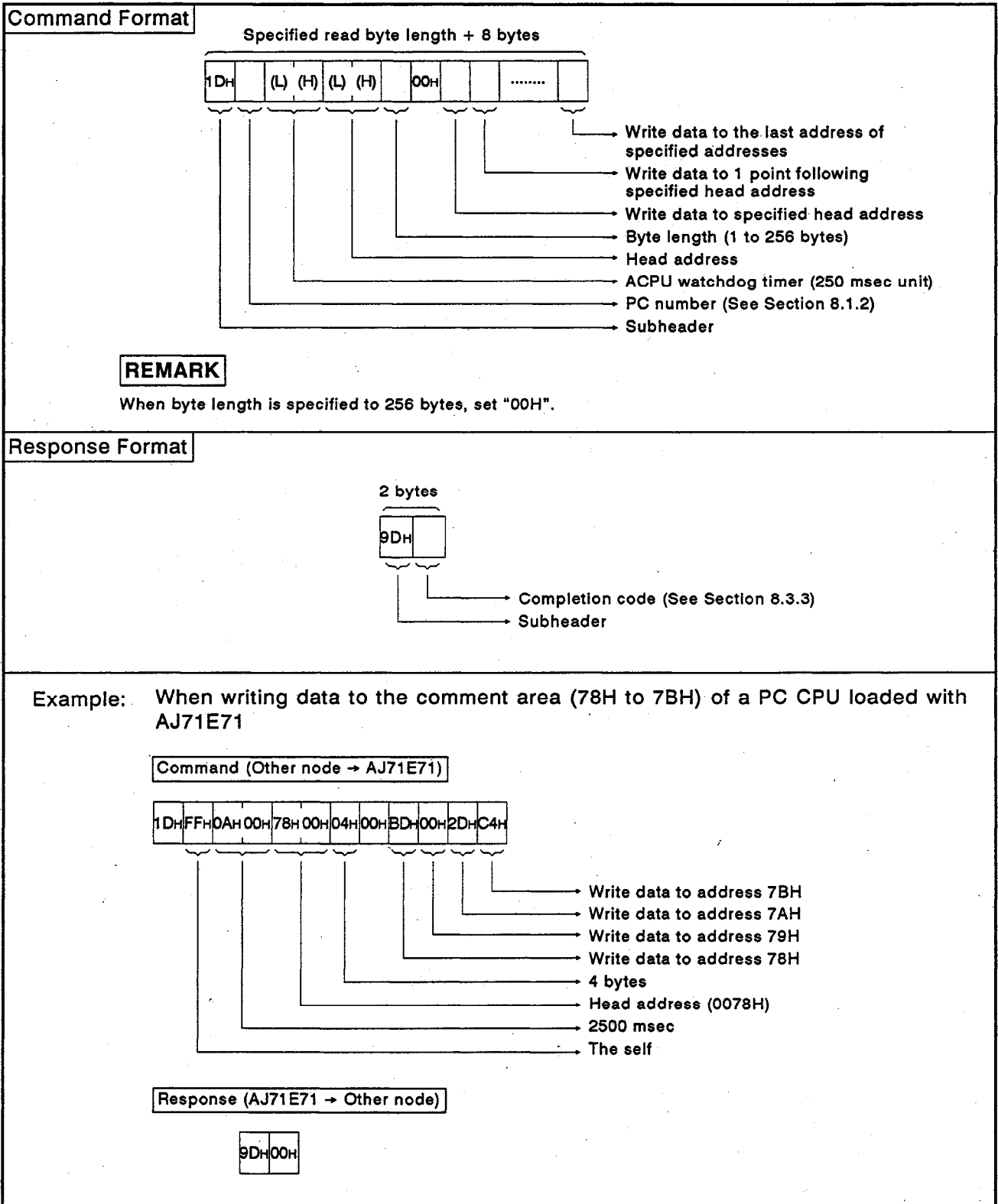

(b) Communications in ASCII code

Command Format

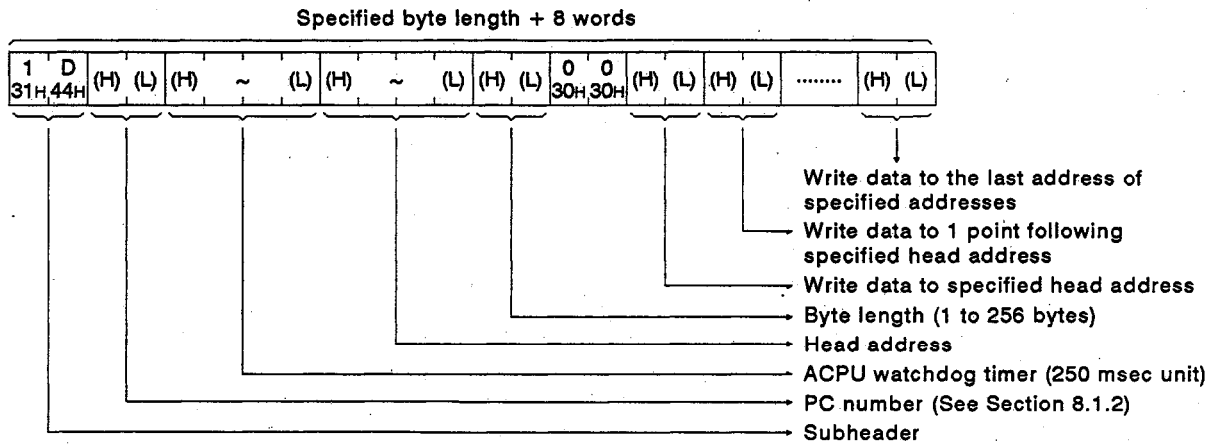

REMARK

When byte length is specified to 256 bytes, set "3030H".

Response Format

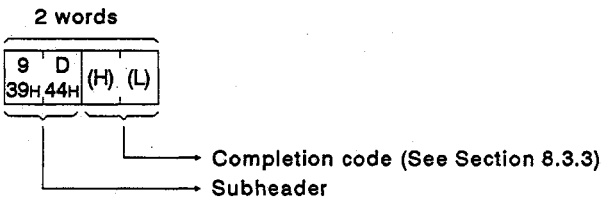

Example: When writing a main microcomputer program (78H to 7BH) of a PC CPU loaded with AJ71E71

Command (Other node → AJ71E71)

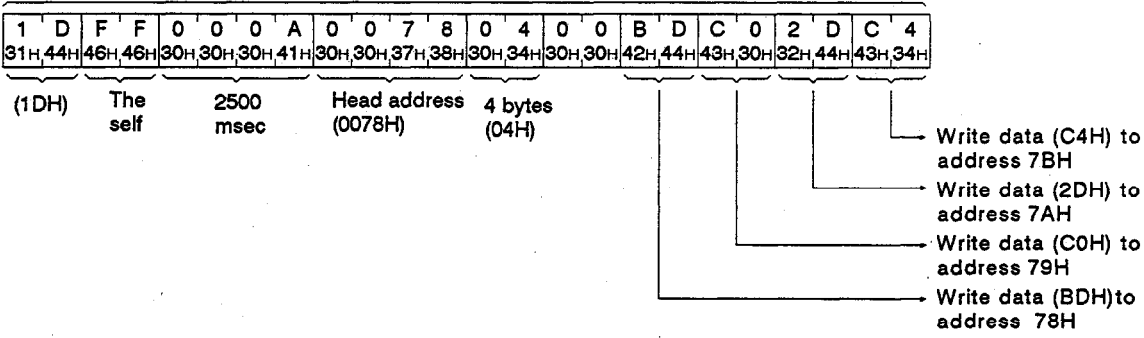

Response (AJ71E71 → Other node)

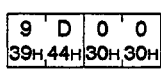

8.8.7 Read/write of extension comment

The following explains the specification contents and method and the specification example of a protocol when the microcomputer program of a PC CPU is read and is written:

(1) Extension command and address

The command/response classification and the program addresses are as follows when read/write of comment data is done:

(a) Table 8.16 shows the functions for the read/write of AnACPU dedicated command comment data.

Table 8.16 Functions

Item	Command/ Response Classifica- tion	Processing	Number of Points Processed per Communica- tion	State of PC CPU		
				During STOP	During RUN	
					SW22 ON	SW22 OFF
Batch read	39H	Reads the extension comment data.	256 bytes	o	o	o
Batch write	3AH	Writes the extension comment data.		o	o	x

Note : o.....Executable
x.....Not executable

(b) Extension comment memory address

The extension comment data storage area is managed by the relative address which gains with the head address of 00H.

For example, when the comment capacity of parameter is 2k bytes, the range from 00H to 7FFH can be specified for the head address.

1) The extension comment memory can be set up to 64k bytes.

The address range of comment data is fixed according to the set capacity of parameter.

2) Specify an extension comment memory address in hexadecimal.

3) When the sum of a head address and the number of bytes is larger than extension comment memory capacity, an error (completion code 57H) occurs.

POINT

Comment data cannot be read or written by setting a specific device and device number.

Start reading or writing beginning with address 0H.

(2) Batch read

The command and the response formats are as follows when batch read of comment memory is done:

(a) Communications in binary code

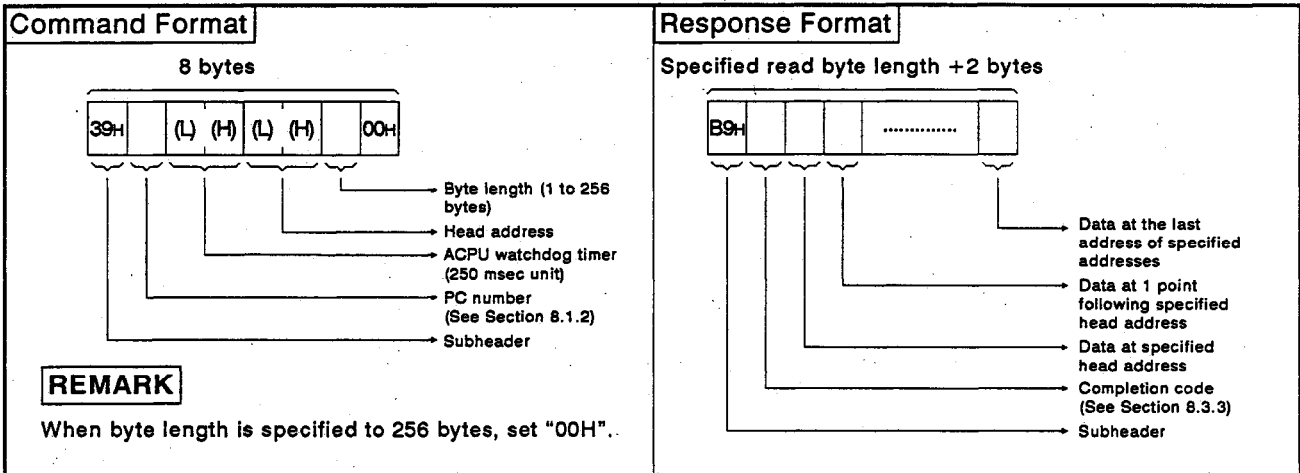

Example: When reading comments (1E0H to 1E3H) of a PC CPU loaded with AJ71E71

Command (Other node → AJ71E71)

Response (AJ71E71 → Other node)

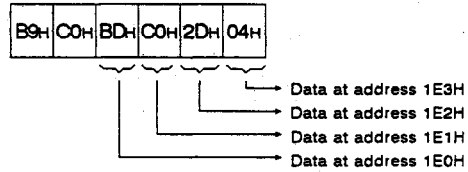
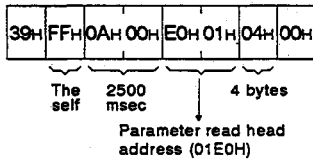

(b) Communications in ASCII code

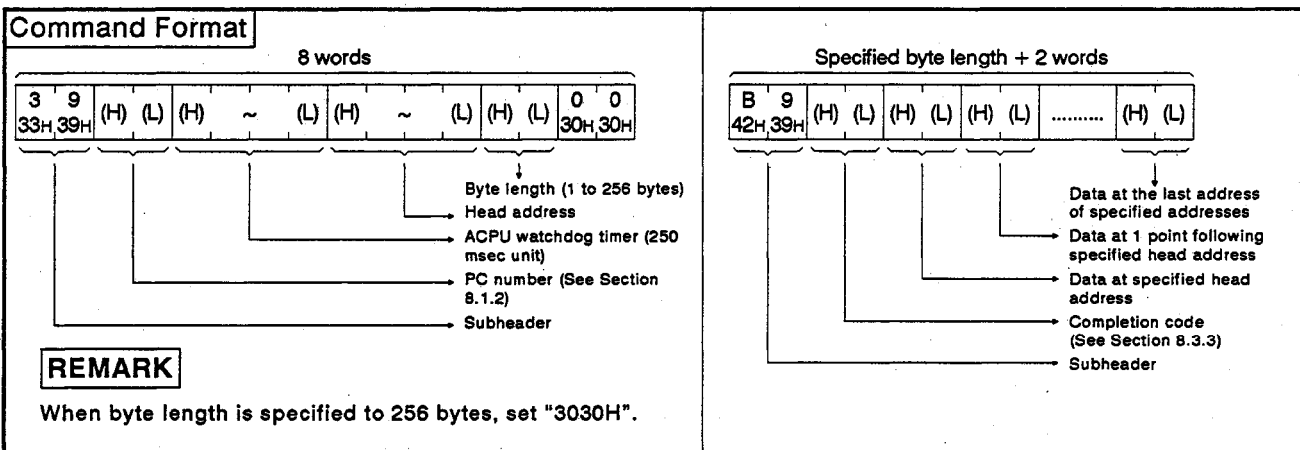

Example: When reading comments (1E0H to 1E3H) of a PC CPU loaded with AJ71E71

Command (Other node → AJ71E71)

Response (AJ71E71 → Other node)

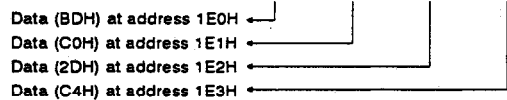
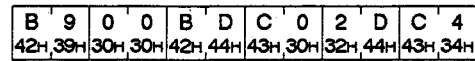
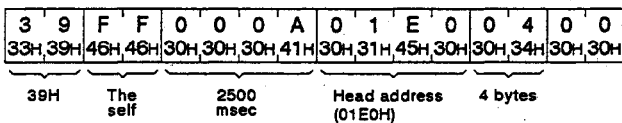

(3) Batch write

The command and response formats are as follows when the batch write of comment memory is done:

(a) Communications in binary code

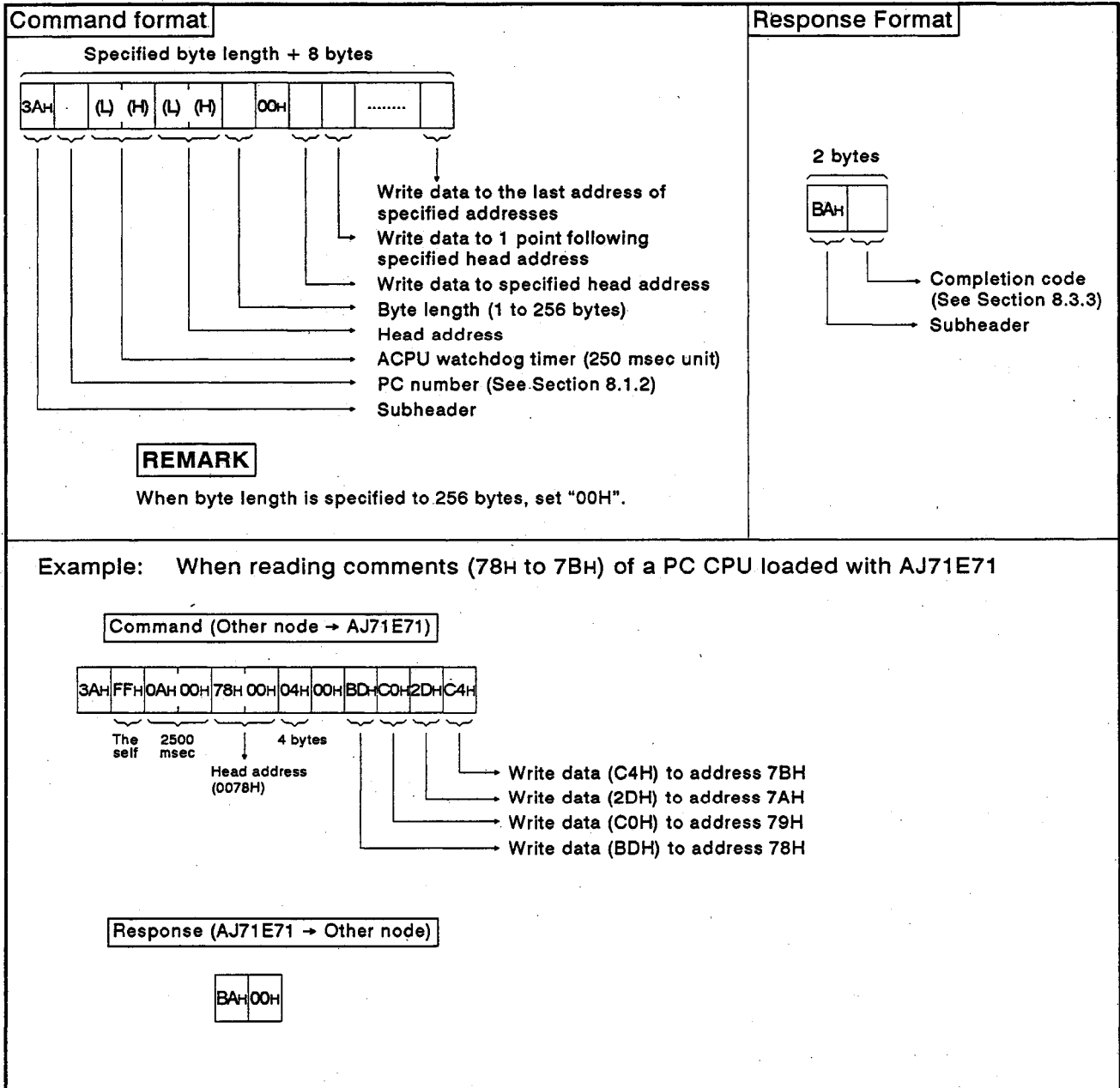

(b) Communications in ASCII code

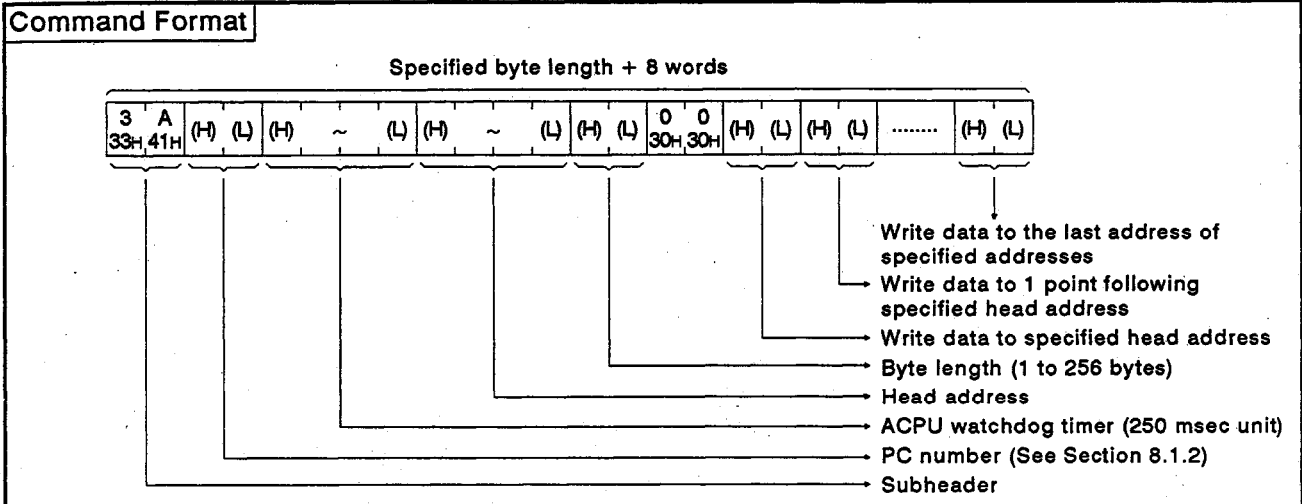

REMARK

When byte length is specified to 256 bytes, set "3030H".

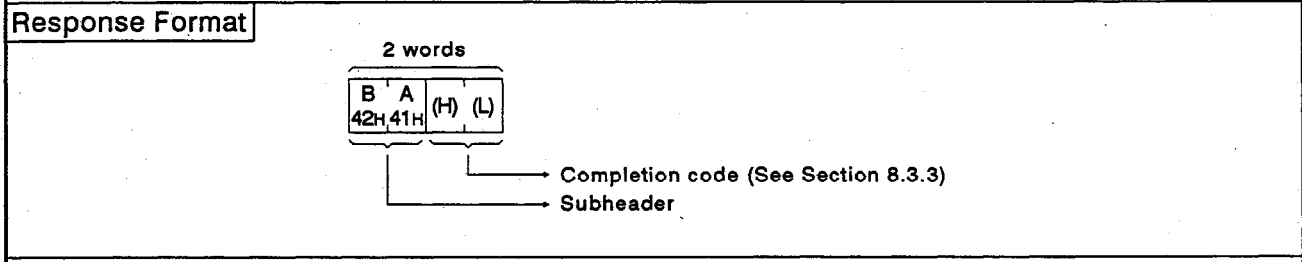

Example: When writing data to the comment area (78H to 7BH) of a PC CPU loaded with AJ71E71

Command (Other node → AJ71E71)

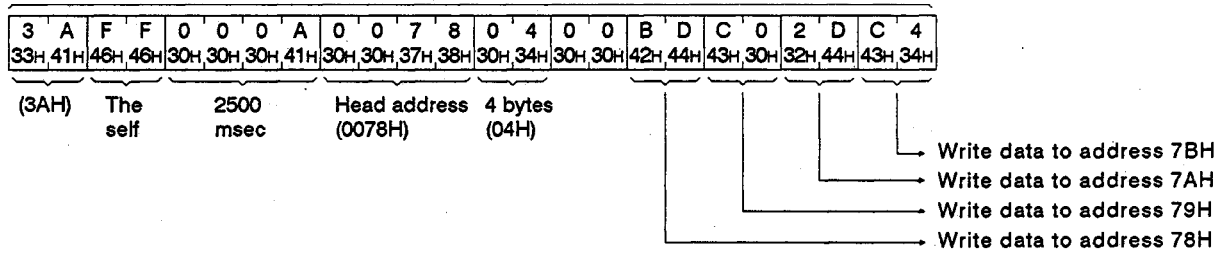

Response (AJ71E71 → Other node)

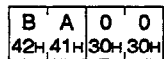

8. READING AND WRITING DATA STORED IN THE PC CPU MELSEC-A

8.9 Command and Response Formats for the Loopback Test

The loopback test is used to check normal communications between a communicating station and AJ71E71.

Data transmitted from a station is sent back to the same station as a response from the AJ71E71.

(1) Table 8.17 shows the function of the loopback test.

Table 8.17 Functions

Item	Command/ Response Classifica- tion	Processing	Number of Points Processed per Communica- tion	State of PC CPU		
				During STOP	During RUN	
					SW22 ON	SW22 OFF
Loopback test	16H	Echoes unchanged characters back to the computer.	256 bytes	o	o	o

8. READING AND WRITING DATA STORED IN THE PC CPU

MELSEC-A

The command and response formats are as follows when the loopback test is executed:

(a) Communications in binary code

Command Format

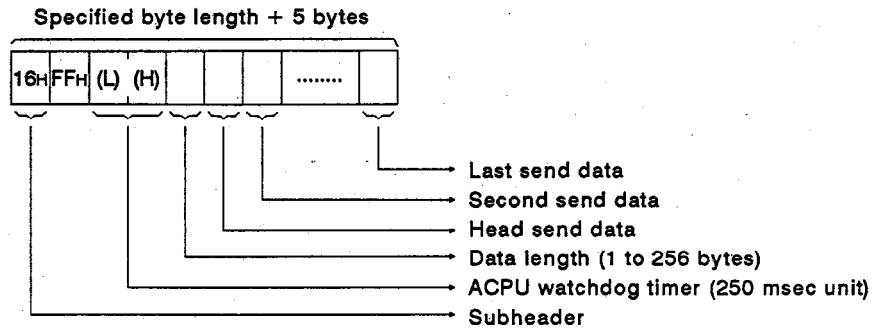

REMARK

When data length is specified to 256 bytes, set "00H".

Response Format

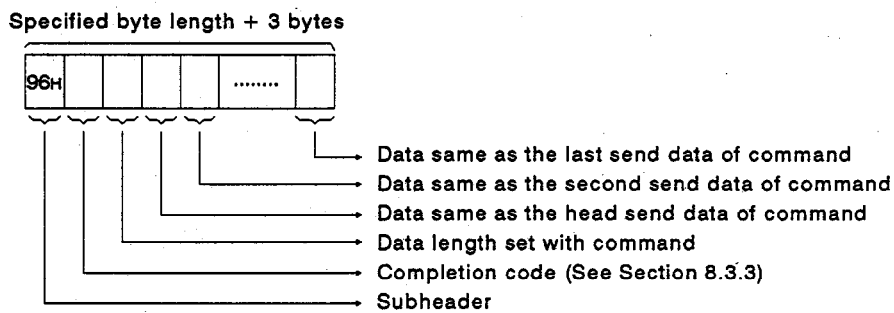

Example: When doing a loopback test by using data (12H, 34H, 56H, 78H)

Command (Other node → AJ71E71)

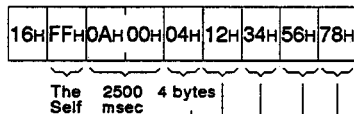

Response (AJ71E71 → Other node)

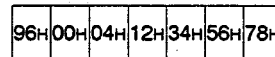

(b) Communications in ASCII code

Command Format

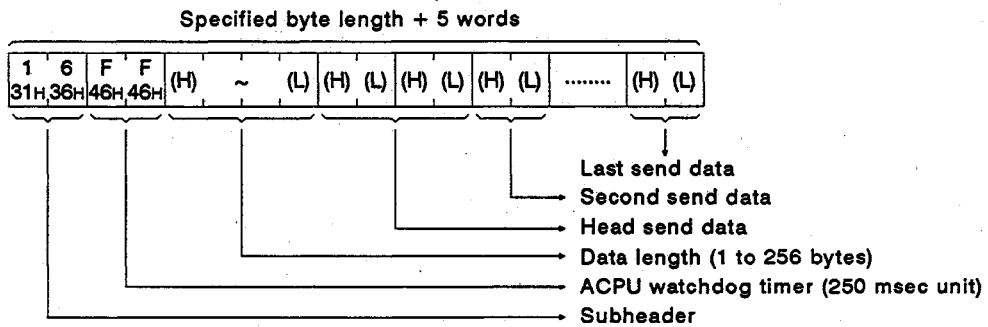

REMARK

When data length is specified to 256 bytes, set "3030".

Response Format

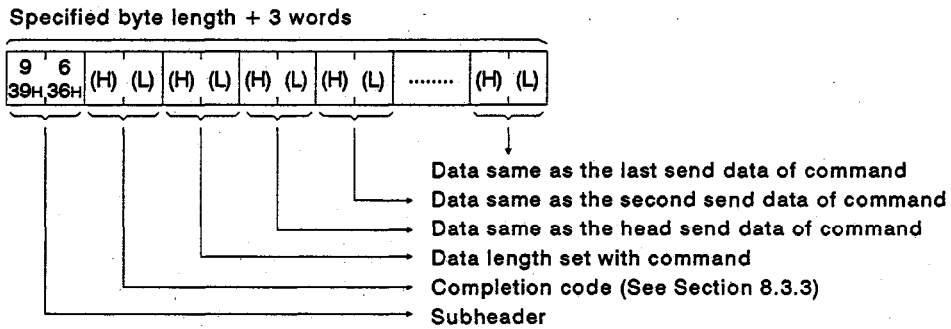

Example: When doing a loopback test by using data (12H, 23H, 45H, 67H)

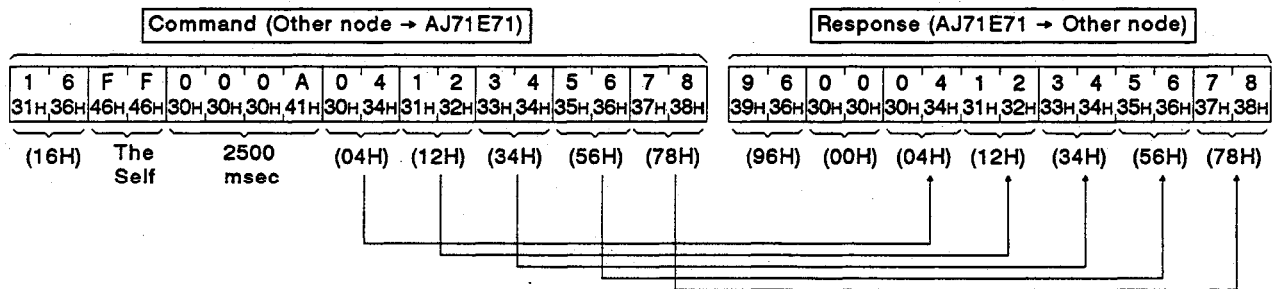

9. TROUBLESHOOTING

9.1 Error Code List

Errors occurring during communications between the AJ71E71 and a communicating node are classified into the following four types:

(1) Initialization error codes

Initialization parameter setting error code is stored.

(2) Communication line opening error codes

Communication line open parameter setting error code is stored.

(3) Fixed buffer send error code

The code of communication error occurring in sending data using fixed buffer is stored.

(4) Error log area storing error code

The code of communication error occurring in other than sending data using fixed buffer is stored.

9.1.1 Initialization error code list

Initialization error code is stored in the initialization error storing area (buffer address 80H).

Error Code	Description	Corrective Action
201H	The IP address setting of the AJ71E71 is either '0' or 'FFFFFFFH'.	Correct the IP address of the AJ71E71.
8002H	Although initialization has not been completed for the initialization request (X19: ON), initialization request is given again.	Give an initialization request only after the previous initialization processing has been completed.
8004H	System error	Initialize the AJ71E71.
8005H	Initialization error due to an error in initialization parameter.	Check and correct the initialization parameter setting.

9.1.2 Communication line opening error code list

Communication line opening error code is stored in the communication line opening error code storing area (buffer addresses 93, 103,) of each connection.

Error Code	Description	Corrective Action
71H	Data of the set length has not been received within the duration set by a response watchdog timer. Actual data is shorter than the set data length.	Correct the set data length.
101H	The port number for the AJ71E71 is set within a range of 0H to 00FFH.	Correct the port number. A port number should be set within a range of 0100H to FFFFH.
102H	The port number for the communicating node is set within a range of 0H to 00FFH.	Correct the port number. A port number should be set within a range of 0100H to FFFFH.
103H	In communications using the TCP/IP protocol, the same combination of the AJ71E71 port number and communicating node port number as the connection that has been opened is set.	Correct the communication address setting area of each connection.
104H	In communications using the UDP/IP protocol, the same AJ71E71 port number is set for more than one connection.	Correct the communication address setting area of each connection.
105H	The AJ71E71 has not been initialized.	Initialize the AJ71E71.
106H	The IP address setting of the communicating node is either "0" or "FFFFFFFH"	Correct the IP address of the communicating node.
107H	The same AJ71E71 port number is used.	Change the AJ71E71 port number.
7004H	In the communication line opening processing of the TCP connection, connection has not been established.	Correct the value in the application setting area of each connection. Check the connection processing of the communicating node.
8004H	System error	Initialize the AJ71E71.
9002H	Fixed buffer sending has been executed with close processing still in progress after the open request signal (Y8 to YF) has been switched OFF (but before the open completed signal (X0 to X17) has gone OFF).	Execute fixed buffer sending when both the open request signal (Y8 to YF) and the open completed signal (X0 to X17) for the relevant connection are ON.
9059H	In communications using the TCP/IP protocol, the TCP ULP time-out error occurred. (ACK is not returned from the communication node in communications using the TCP protocol.)	Check the Ethernet cable if it is connected securely. Check the operating status of the communicating node. Correct the TCP UPL time setting of the initial parameters.
A009H	The Ethernet address that corresponds to the designated IP address does not exist.	Check the IP address. Set the Ethernet address if the ARP function is not used (see Section 5.3).
B000H	Send error	Check the cable, AJ71E71 hardware, etc.

9.1.3 Fixed buffer send error code list

Fixed buffer send error code is stored in the fixed buffer send error code storing area (buffer addresses 94, 104,) of each connection.

Error Code	Description	Corrective Action
01H	Communication data length exceeds the maximum allowable length: Binary code1018 words ASCII code509 words	Correct the data length of the data to be sent.
62H	A code other than "00H" (normal completion) is returned from the communication node as the response end code in communications using fixed buffer.	Read the response end code returned from the communicating node stored in buffer memory addresses 95, 105,
70H	A response is not returned within a duration set by the response watchdog timer.	Check the operation of the communicating node. If the setting of the response watch dog timer is too small, change it to a larger one.
71H	Data of the set length has not been received within the duration set by a response watchdog timer. Actual data is shorter than the set data length.	Correct the set data length.
80H	Communication line opening processing for the connection in question is not completed.	Execute opening processing.
81H	An Ethernet address that does not exist is designated. (Only when the UDP I/P is used.)	Check the Ethernet address of the communicating node. If the APR function is used, do not set the Ethernet address using the IP address.
105H	The AJ71E71 has not been initialized.	Initialize the AJ71E71. Execute opening processing.
8004H	System error	Initialize the AJ71E71.
9001H	Communication line opening processing for the connection in question is not completed.	Execute opening processing.
9002H	Fixed buffer sending has been executed with close processing still in progress after the open request signal (Y8 to YF) has been switched OFF (but before the open completed signal (X0 to X17) has gone OFF).	Execute fixed buffer sending when both the open request signal (Y8 to YF) and the open completed signal (X0 to X17) for the relevant connection are ON.
9005H	Internal resource is insufficient for the TCP request. Send buffer size is insufficient.	Send the same data again. Next data might be sent without confirming the response from the communicating node. Send the next data only after the response has been received.
9008H	Internal resource is insufficient for the UDP request. Send buffer size is insufficient.	Send the same data again. Next data might be sent without confirming the response from the communicating node. Send the next data only after the response has been received.
9059H	In communications using the TCP/IP protocol, the TCP ULP time-out error occurred. (ACK is not returned from the communication node in communications using the TCP protocol.)	Check the Ethernet cable if it is connected securely. Check the operating status of the communicating node. Correct the TCP UPL time setting of the initial parameters.
B000H	Send error	Check the cable, AJ71E71 hardware, etc.

9.1.4 List of error codes stored in error log area

Minor errors (physical layer to transport layer, see Section 9.2) occurred in data receiving using fixed buffer, communications using random access buffer, and general data communications are stored in the error log area (buffer addresses: 168 to 178)

Error Code	Description	Corrective Action
71H	Data of the set length has not been received within the duration set by a response watchdog timer.	Correct the set data length.
81H	An Ethernet address that does not exist is designated. (Only when the UDP I/P is used.)	Check the Ethernet address of the communicating node. If the ARP function is used, do not set the Ethernet address using the IP address.
105H	The AJ71E71 has not been initialized.	Initialize the AJ71E71.
8004H	System error	Initialize the AJ71E71.
9001H	Communication line opening processing for the connection in question is not completed	Execute opening processing.
9002H	Fixed buffer sending has been executed with close processing still in progress after the open request signal (Y8 to YF) has been switched OFF (but before the open completed signal (X0 to X17) has gone OFF).	Execute fixed buffer sending when both the open request signal (Y8 to YF) and the open completed signal (X0 to X17) for the relevant connection are ON.
9005H	Internal resource is insufficient for the TCP request. Send buffer size is insufficient.	Send the same data again. Next data might be sent without confirming the response from the communicating node. Send the next data only after the response has been received.
9006H	Check sum error in received data in communications using the TCP protocol	Check the check sum calculation in the communicating node.
9008H	Internal resource is insufficient for the UDP request. Send buffer size is insufficient.	Send the same data again. Next data might be sent without confirming the response from the communicating node. Send the next data only after the response has been received
9009H	Check sum error in received data in communications using the UDP protocol.	Check the check sum calculation in the communicating node.
9059H	In communications using the TCP/IP protocol, the TCP ULP time-out error occurred. (ACK is not returned from the communication node in communications using the TCP protocol.)	Check the Ethernet cable if it is connected securely. Check the operating status of the communicating node. Correct the TCP ULP time setting of the initial parameters.
A001H	An illegal IP address (network number) is used. (ICMP error packet is received while the IP address of the IP packet sent to the communicating node is incorrect.)	Check the IP address of the communicating node set in the AJ71E71. Check the IP address of the communicating node.
A002H	An illegal IP address (host number) is used. (ICMP error packet is received while the IP address of the IP packet sent to the communicating node is identical.)	Check the IP address of the communicating node set in the AJ71E71. Check the IP address of the communicating node.
A004H	An illegal port number is used. (ICMP error packet is received while the port number of the IP packet sent to the communicating node is not registered in it.)	Check and correct the port number of the communicating node.
A006H	ICMP error packet is received when an assemble time-out error occurred in the communicating node.	Check the Ethernet cable if it is connected securely and the termination processing at the transceiver. If the IP assemble timer setting is too small, change it to a larger value

Error Code	Description	Corrective Action
A007H	IP assemble time-out error. (Time-out occurred with the remaining portion of divided data not received.)	Check the Ethernet cable if it is connected securely and the termination processing at the transceiver. If the IP assemble timer setting is too small, change it to a larger value. Check the operation of the communicating node.
A00BH	ICMP error packet that cannot be analyzed by the system is received.	Check the reason the communicating node has sent that ICMP packet.
A00CH	ICMP error packet not supported by the system is received.	The system supports only the echo, time-stamp, and the response to information request.
A00DH	Check sum error with the header of the IP packet received.	Check the check sum calculation at the communicating node.
A00EH	Sending data is impossible due to full internal buffer like IP header buffer.	Send the same data again.
B000H	Send error	Check the cable, AJ71E71 hardware, etc.

REMARK

Communication data will be divided in portions due to the restrictions on buffer size of the host and/or communicating node. The data received in portions is reassembled by the AJ71E71 and communicated using fixed buffer or random access buffer. Data reassembling is made based on the data length in the communicated data.

An error occurs if the set data length and actual data length differ from each other.

(a) If actual data length is shorter than the set data length:

Data receive waits until the data of the set length is received. After the elapse of the time set by the response watchdog timer, an error occurs and the connection closes automatically.

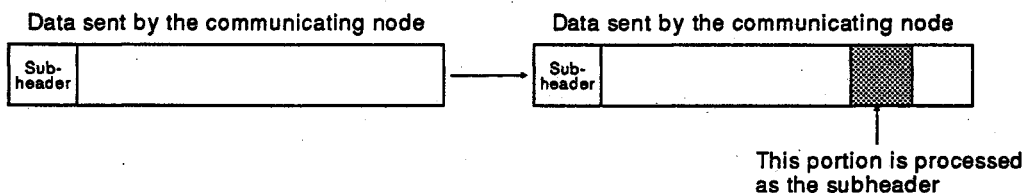

(b) If actual data length is larger than the set data length:

The data of the set data length is processed as the first data and the remaining data is going to be processed as the second data. In this case, as the second data does not have the subheader and therefore the command/response type undefined error occurs.

9.2 Troubleshooting Flowchart

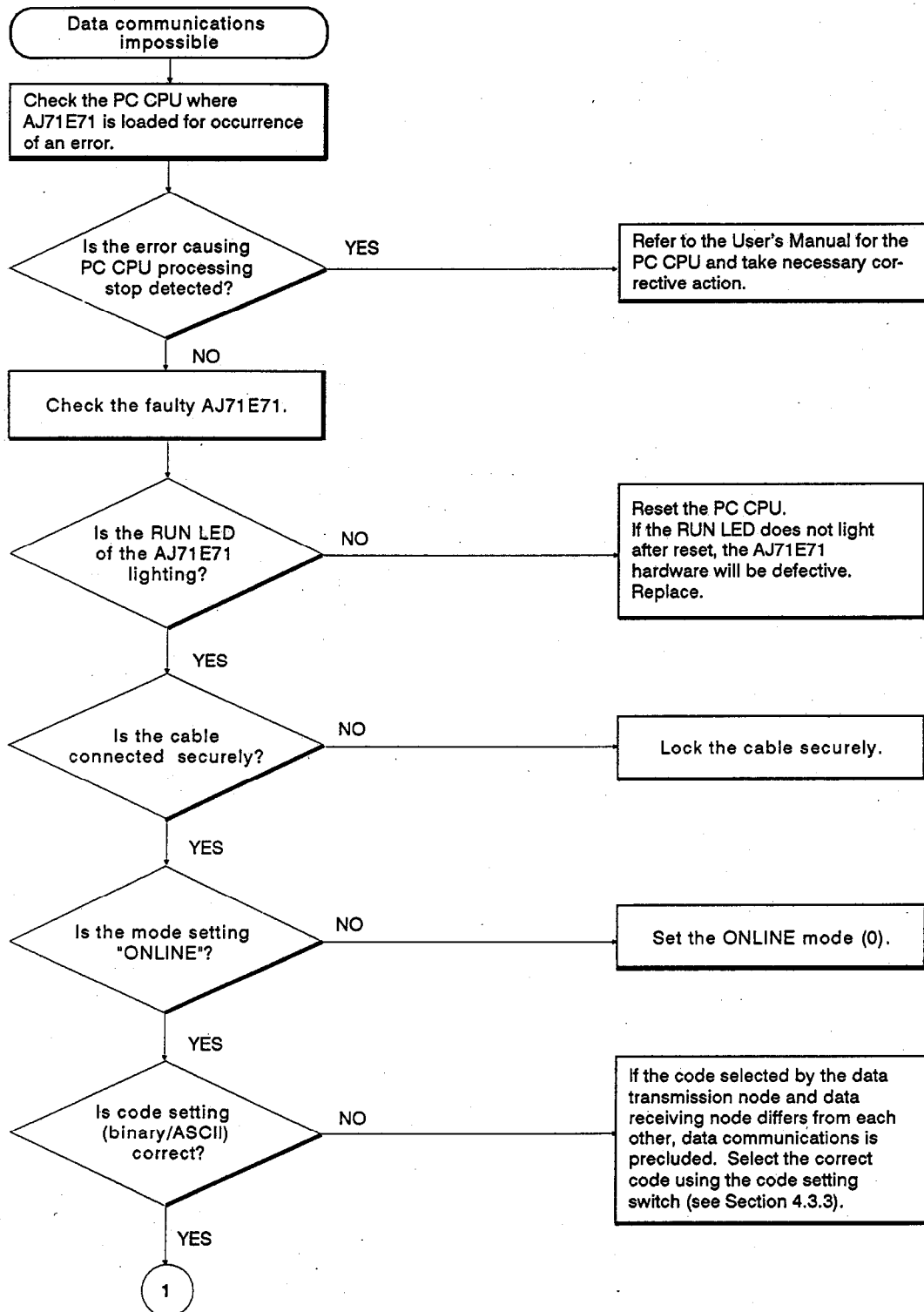

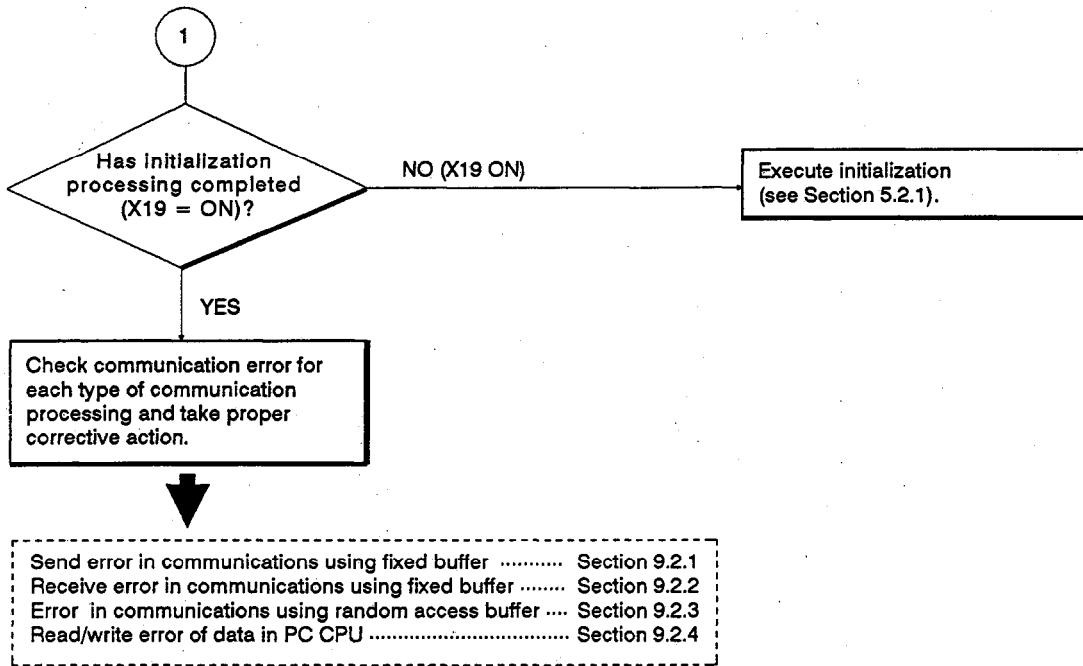

9.2.1 Send error in communications using fixed buffer

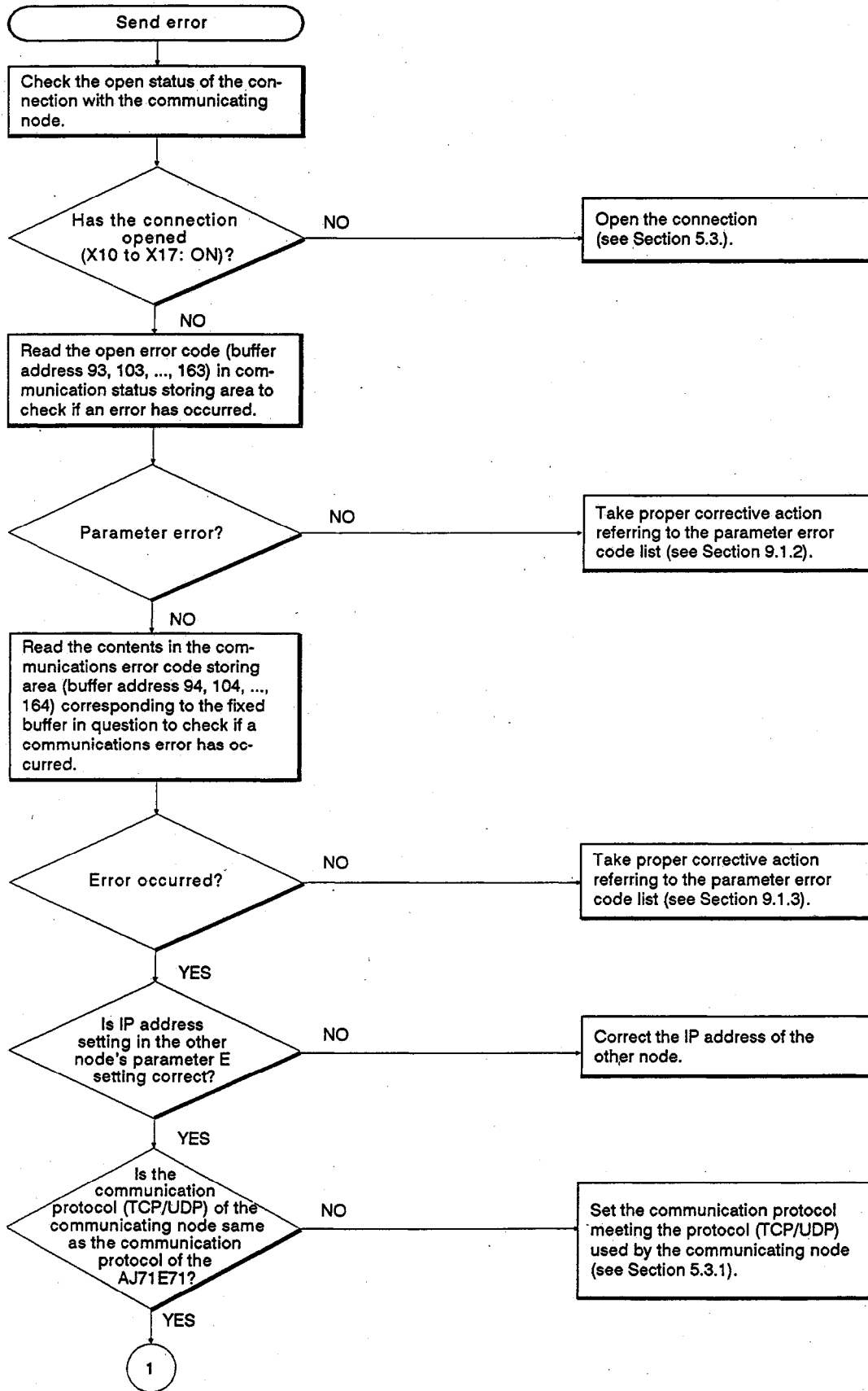

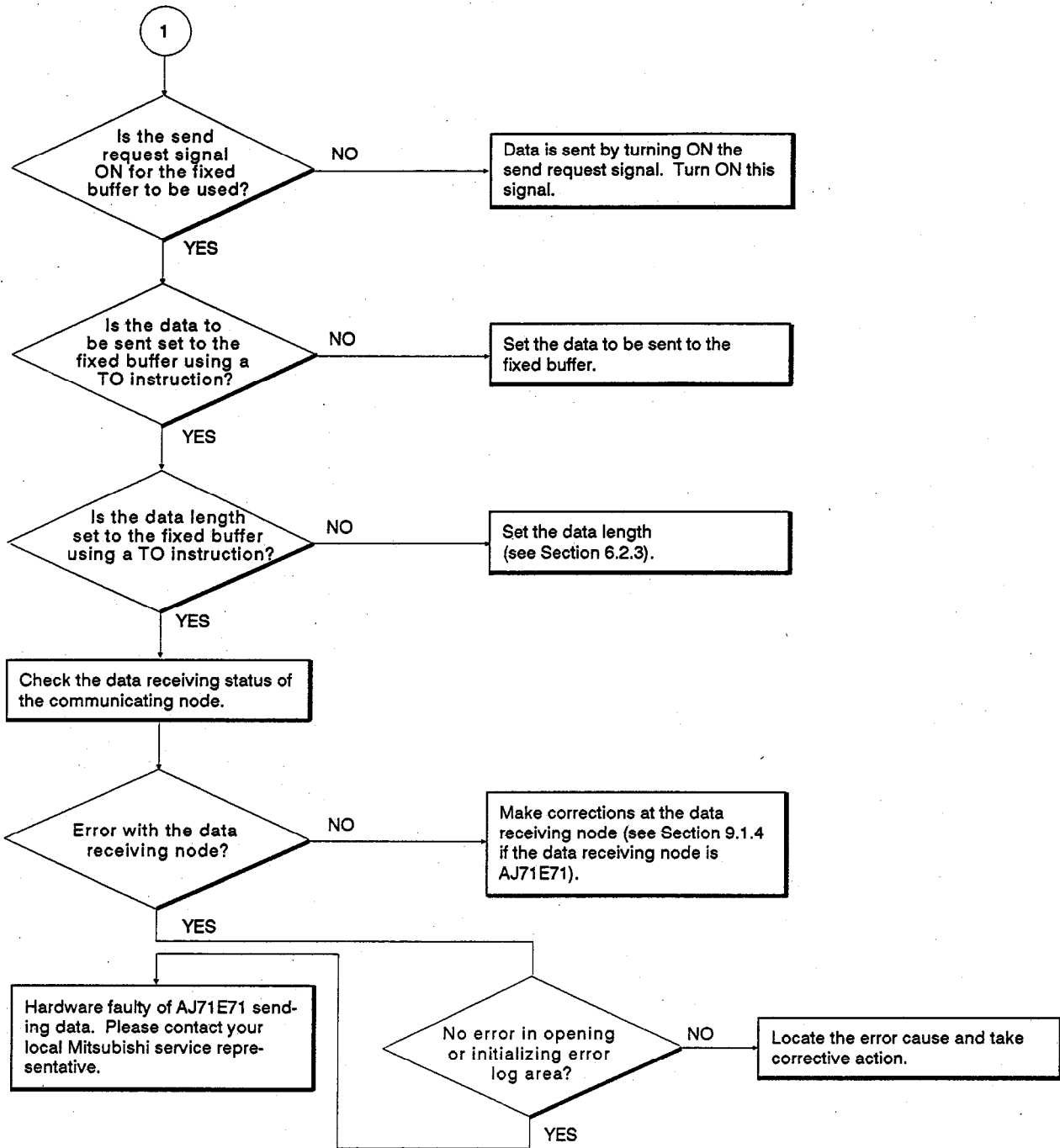

9.2.2 Receive error in communications using fixed buffer

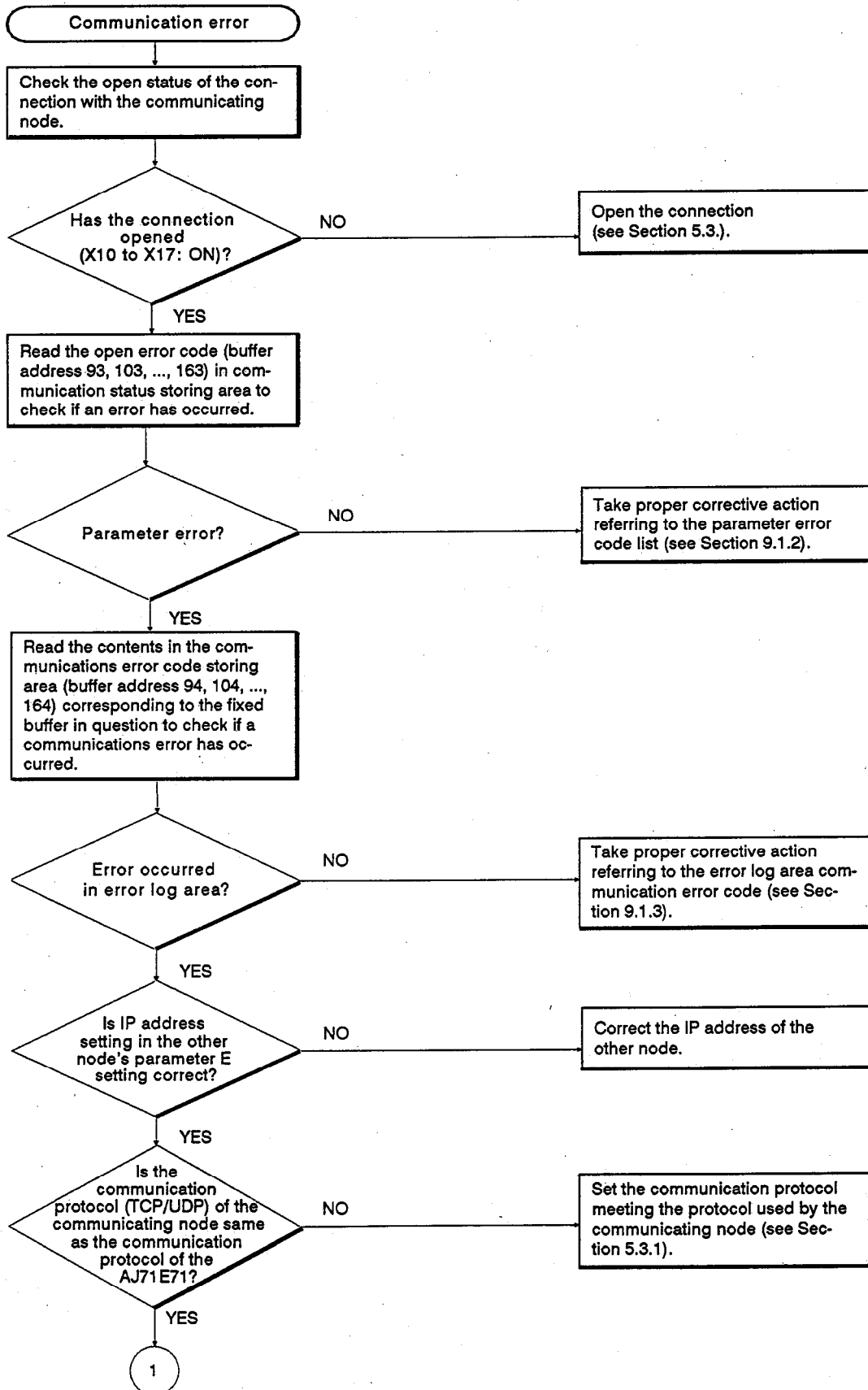

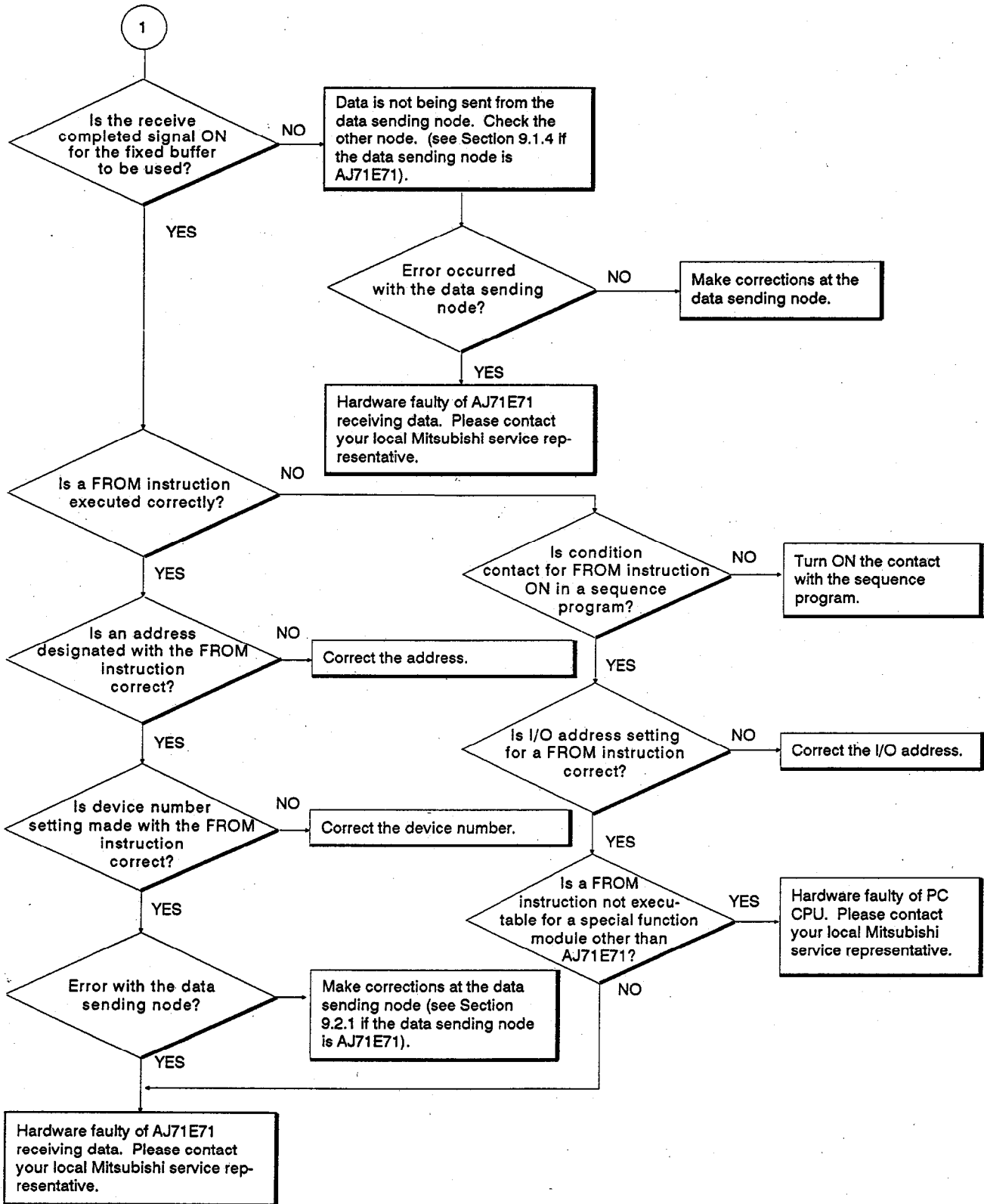

9.2.3 Error in communications using random access buffer

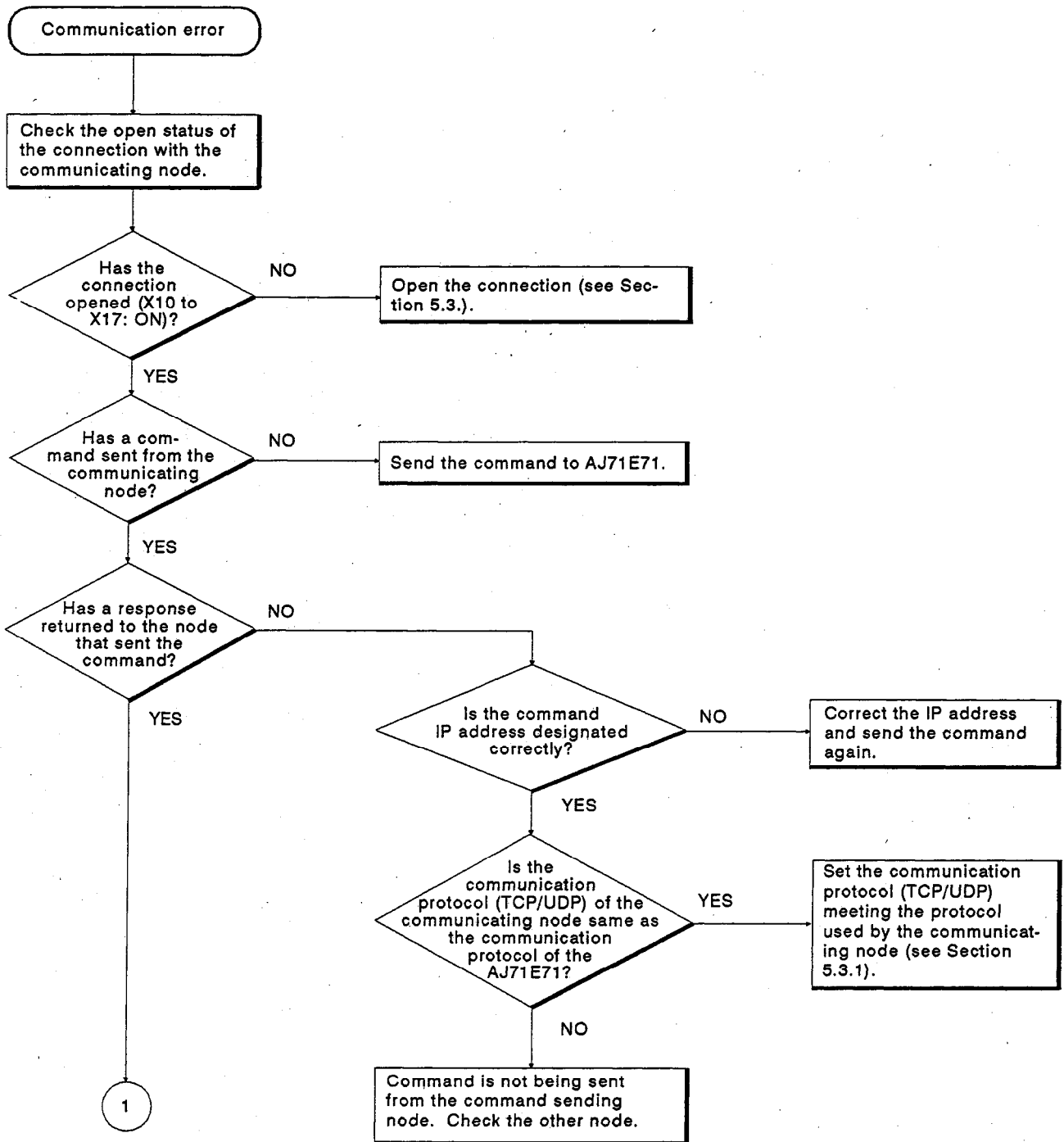

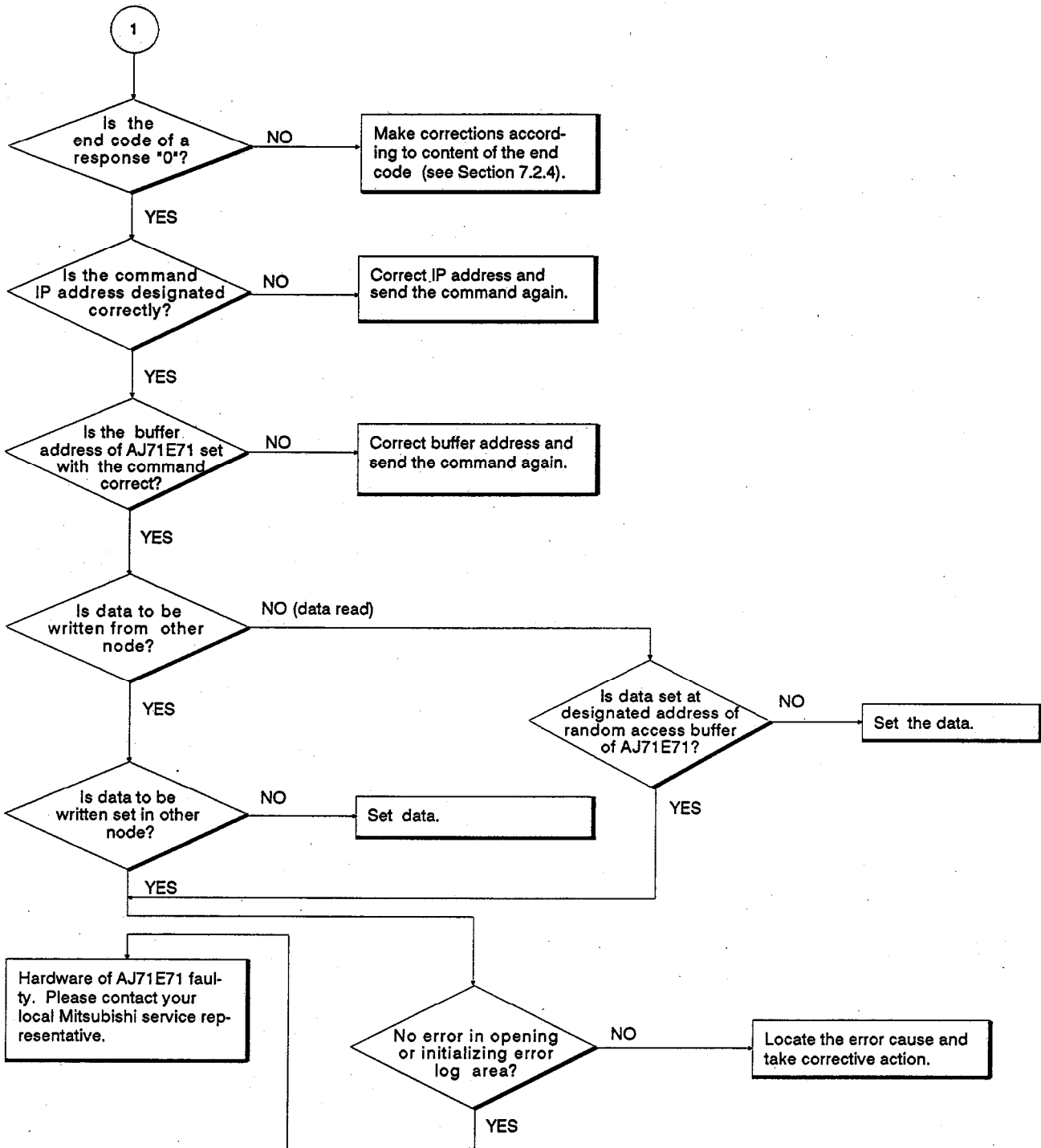

9.2.4 Read/write error of data in PC CPU

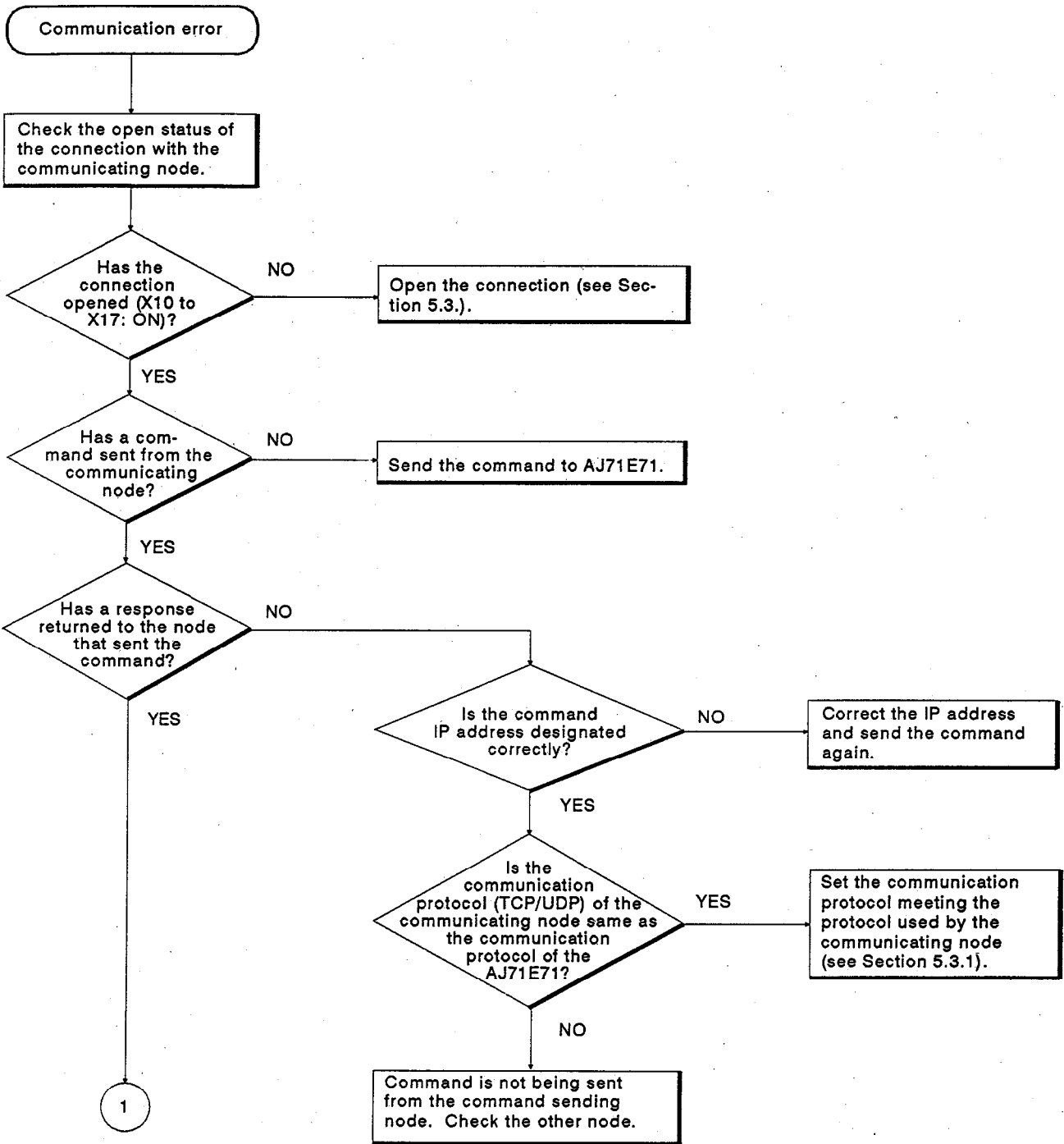

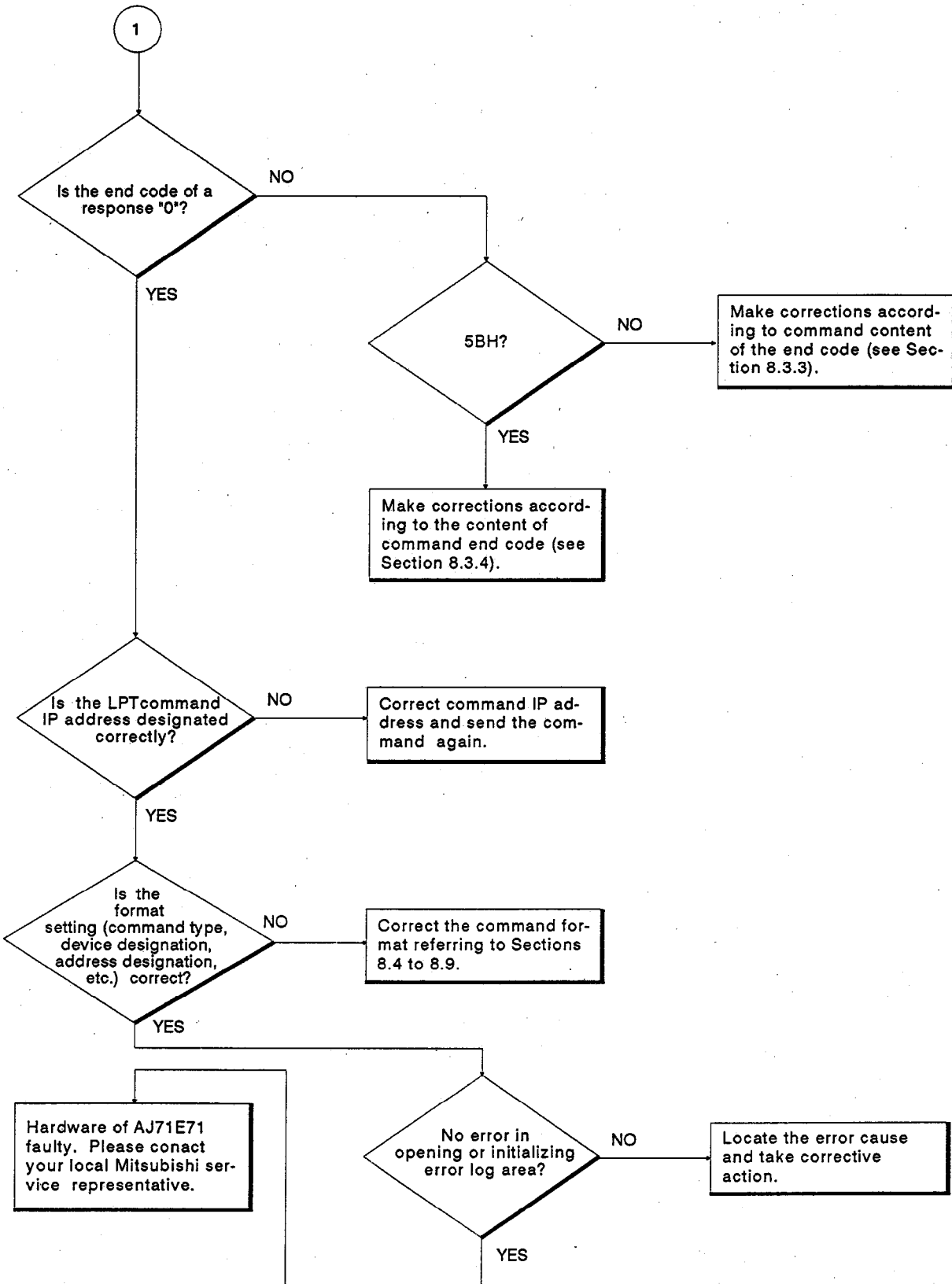

APPENDICES

APPENDIX 1 PROCESSING TIME

Calculate the minimum transmission delay time of each function using the following formulas:

It should be noted that the minimum delay time could be longer than the calculation. This is because it is influenced by the network load ratio (to the extent the line is utilized), window size of individual nodes, number of connections used simultaneously, and system configuration. Use the value obtained from the formulas as a reference value when communications are executed with only one connection.

- (1) Minimum transmission delay time in communications using fixed buffer (communications between two AJ71E71 modules)

(a) TCP/IP

$$47 + (0.025 \times \frac{\text{Command data length}}{\text{In byte}}) + (0.025 \times \frac{\text{Response data length}}{\text{In byte}}) +$$

(Scan time at the data receiving node) + (Scan time at the data sending node) (msec)

(b) UDP/IP

$$47 + (0.023 \times \frac{\text{Command data length}}{\text{In byte}}) + (0.023 \times \frac{\text{Response data length}}{\text{In byte}}) +$$

(Scan time at the data receiving node) + (Scan time at the data sending node) (msec)

Command data length: This includes subheader, data length, and text data. This data is set in the command application data area when data stored in the fixed buffer memory is transmitted. The command data length is processed by the byte.

In binary data, command data length is "4 + (data length) × 2".

In ASCII data, command length is "4 + (data length) × 4".

Response data length: This includes subheader and completion code. This data is set in the command application data area when data stored in the fixed buffer memory is stored. The command data length is processed by the byte.

In binary data, response data length is "2".
In ASCII data, response data length is "4".

[Calculation example]

The minimum transmission delay time when 1017 words data (binary data) is sent from an AJ71E71 to another AJ71E71 by using the TCP/IP protocol:

(Assume that scan time is 100 msec at the data sending node and 80 msec at the data receiving node.)

$$47 + (0.025 \times (4 + (1017 \times 2))) + (0.025 \times 2) + 100 + 80 = 278 \text{ (msec)}$$

(2) Minimum transmission delay time in communications using random access buffer memory

(a) TCP/IP

$$30 + (0.018 \times \frac{\text{Command data length}}{\text{In byte}}) + (0.007 \times \frac{\text{Response data length}}{\text{In byte}}) + \text{(ACK processing time at the communicating node) (msec)}$$

(b) UDP/IP

$$30 + (0.017 \times \frac{\text{Command data length}}{\text{In byte}}) + (0.006 \times \frac{\text{Response data length}}{\text{In byte}}) \text{ (msec)}$$

Command data length:

This includes subheader, data length, and text data. This data is set in the command application data area when read/write to the random access buffer memory is executed. The data length is processed by the unit.

To read binary data, command data length is "6".

To write binary data, command data length is "6 + (data length) × 2".

To read ASCII data, command data length is "12".

To write ASCII data, command data length is "12 + (data length) × 4".

Response data length:

This includes subheader and completion code.

This data is set in the command application data area when read/write operation to the random access buffer memory is executed. Data length is processed by the byte.

To read binary data, response data length is "2+ (data length) × 2".

To write binary data, response data length is "2".

To read ASCII data, response data length is "4 + (data length) × 4".

To write of ASCII data, response data length is "4".

ACK processing time by communicating node:

The time in which ACK is returned from the communicating node for read/write operation using random access buffer.

[Calculation example 1]

The minimum transmission delay time when reading 508 words of data (ASCII data) using the UDP/IP protocol.

$$30 + (0.017 \times 12 + (0.006 \times (4 + (508 \times 4)))) = 43 \text{ (msec)}$$

[Calculation example 2]

The minimum transmission delay time when writing 508 words of data (ASCII data) using the UDP/IP protocol.

$$30 + (0.017 \times (12 + (508 \times 4))) + (0.006 \times 4) = 65 \text{ (msec)}$$

(3) Minimum transmission delay time for read/write operation of data in PC CPU

(a) TCP/IP

$$30 + (0.018 \times \frac{\text{Command data length}}{\text{In byte}}) + (0.007 \times \frac{\text{Response data length}}{\text{In byte}}) +$$

(PC CPU processing time) +

(Time to receive ACK from the communicating node) (msec)

(b) UDP/IP

$$30 + (0.017 \times \frac{\text{Command data length}}{\text{In byte}}) + (0.006 \times \frac{\text{Response data length}}{\text{In byte}}) +$$

(PC CPU processing time) (msec)

Command data length:

This includes subheader, data length, and text data. This data is set in the command application data portion when read/write operation of data in the PC CPU is done. The data length is processed by the byte. The command data length varies according to the command to be used. See Section 8.

Response data length:

This includes subheader, data length, and text data. This data is set in the response application data area when read/write operation of data in the PC CPU is done. The data length is processed by the byte. The response data length varies according to the command to be used. See Section 8.

PC CPU processing time:

The time in which read/write request of data in the PC CPU is processed. This is determined by the type of data to be read/written, number of processing points, and PC CPU scan time. See table 1.1.

$$\text{PC CPU processing time} = \frac{(\text{Designated number of points}) + (\text{Number of processing points per sequence program scan}) \times (\text{scan time})}{\text{Round off to the nearest decimal point}}$$

Time to receive ACK from the communicating node:

The time in which ACK is returned from the communicating node after the completion of read/write operation of the data in the PC CPU.

[Calculation example 1]

The minimum transmission delay time for reading data (ASCII) at 100 points of data registers (D) using the TCP/IP protocol. (Assume that scan time is 100 msec.)

Command data length = 24 bytes

Response data length = 404 bytes

PC CPU processing time = $(100 + 64) \times 100 = 200$ (msec)

Minimum transmission

$$\begin{aligned} \text{delay time} &= 30 + (0.018 \times 24) + (0.007 \times 404) + 200 + \\ &\quad \text{(time to receive ACK from the communicating node)} \\ &= 234 + \text{(time to receive ACK from the communicating node)} \\ &\quad \text{(msec)} \end{aligned}$$

[Calculation example 2]

The minimum transmission delay time for writing data (ASCII) at 100 points of data registers (D) using the TCP/IP protocol. (Assume that scan time is 100 msec.)

Command data length = 424 bytes

Response data length = 4 bytes

PC CPU processing time = $(100 + 64) \times 100 = 200$ (msec)

Minimum transmission

$$\begin{aligned} \text{delay time} &= 30 + (0.018 \times 424) + (0.007 \times 4) + 200 + \\ &\quad \text{(time to receive ACK from the communicating node)} \\ &= 238 + \text{(time to receive ACK from the communicating node)} \\ &\quad \text{(msec)} \end{aligned}$$

Table 1.1 PC CPU Communication Time

Item			PC CPU Processing Time (time to scan)			AJ71E71 Max. Processing Data between Communicating Nodes	Processing Data with 1 Scan in Sequence Program	Scan Times for Processing			
			ADJ2HCPU A1N, A2N, A3NCPU	A3HCPU	A2A, A3ACPU						
Device data	Device memory	Batch read	Unit of bit	0.76 msec	0.57 msec	1.38 msec	256 points	256 points	1 scan		
			Unit of words	Bit device	1.13 msec	0.81 msec	2.42 msec	128 words (2048 points)	32 words (512 points)	(Specified numbers/32) scan	
				Word device	1.13 msec	0.81 msec	2.42 msec	256 points	64 points	Except device R (Specified numbers/64) scan	
		Batch write	Unit of bit	Unit of bit	1.13 msec	0.94 msec	1.06 msec	256 points	256 points	Device R (Specified numbers/64) + 1 scan	
				Bit device	1.13 msec	0.84 msec	2.60 msec	40 words (640 points)	10 words (160 points)	2 scans (1 scan when "Enabled during RUN" is set) (Specified numbers/64) + 1 scan └─ "0" when "Enabled during RUN" is set.	
			Unit of words	Word device	Unit of words	1.13 msec	0.84 msec	2.60 msec	256 points	64 points	Except device R (Specified numbers/64) + 1 scan └─ "0" when "Enabled during RUN" is set.
					Word device	1.13 msec	0.84 msec	2.60 msec	256 points	64 points	Device R (Specified numbers/64) + 1 scan └─ "0" when "Enabled during RUN" is set.
				Unit of bit	1.13 msec	0.90 msec	1.06 msec	80 points	20 points	(Specified numbers/20) + 1 scan └─ "0" when "Enabled during RUN" is set.	
			Test (random write)	Unit of words	Bit device	1.13 msec	0.90 msec	1.06 msec	40 words (640 points)	10 words (160 points)	(Specified numbers/10) + 1 scan └─ "0" when "Enabled during RUN" is set.

Table 1.1 PC CPU Communication Time (continued)

Item				PC CPU Processing Time (time to scan)			AJ71E71 Max. Processing Data between Communicating Nodes	Processing Data with 1 Scan in Sequence Program	Scan Times for Processing	
				A0J2HCPU A1N, A2N, A3NCPN	A3HCPU	A2A, A3ACPU				
Device data	Device memory	Test (random write)	Unit of words	Word device	1.13 msec	0.90 msec	1.06 msec	40 points	10 points	Except device R (Specified numbers/10) Round off to the nearest decimal point. + 1 scan ↳ "0" when "Enabled during RUN" is set. (Max.5 scans)
					Device R (Specified numbers/10) Round off to the nearest decimal point. + 1 scan ↳ "0" when "Enabled during RUN" is set. (Max.5 scans)					
		Monitor data registration	Unit of bit	—	—	—	—	—	—	
			Unit of words	—	—	—	—	—	1 scan for device R	
		Monitor	Unit of bit	2.02 msec	0.93 msec	1.46 msec	40 points	40 points	1 scan	
			Unit of words	Bit device	2.08 msec	0.96 msec	1.47 msec	320 points (20 words)	320 points (20 words)	1 scan
word device	2.08 msec	0.96 msec		1.47 msec	20 points	20 points				
Device data	Extension file register	Batch read			1.27 msec	0.76 msec	2.42 msec	256 points	64 points	(Specified numbers/64) Round off to the nearest decimal point.
		Batch write			1.27 msec	0.76 msec	2.60 msec	256 points	64 points	
		Direct read			—	—	2.30 msec	256 points	64 points	
		Direct write			—	—	2.57 msec	256 points	64 points	
		Test (random write)			1.31 msec	0.87 msec	0.97 msec	40 points	10 points	(Max.5 scans)
		Monitor data registration			—	—	—	—	—	—
		Monitor			1.75 msec	0.98 msec	1.42 msec	20 points	20 points	1 scan
Special function module	Batch read			FROM instruction processing time + 1.13 msec	FROM instruction processing time + 0.81 msec	FROM instruction processing time + 0.75 msec	256 bytes	128 bytes	(Specified numbers/128) Round off to the nearest decimal point. Scan (Max.2 scans)	
	Batch write								(Specified numbers/128) Round off to the nearest decimal point. + 1 scan ↳ "0" when "Enabled during RUN" is set. (Max.3 scans)	

Table 1.1 PC CPU Communication Time (continued)

Item				PC CPU Processing Time (time to scan)			AJ71E71 Max. Processing Data between Communicating Nodes	Processing Data with 1 Scan in Sequence Program	Scan Times for Processing
				A0J2HCPU A1N, A2N, A3NCPU	A3HCPU	A2A, A3ACPU			
Pro-gram	Se-quence program	Batch read	Main	1.20 msec	0.78 msec	0.70 msec	256 steps	64 steps	(Specified numbers/64) Round off to the nearest decimal point. Scan (Max.4 scans)
			Sub	120 msec	0.84 msec	0.70 msec			
		Batch write	Main	0.67 msec	0.55 msec	0.49 msec	256 steps	64 steps	
			Sub	0.67 msec	0.55 msec	0.49 msec			
	Micro-com-puter program	Batch read	Main	1.35 msec	0.76 msec	—	256 bytes	128 bytes	(Specified numbers/128) Round off to the nearest decimal point. + 1 scan (Max.3 scans)
			Sub	1.35 msec	0.76 msec				
		Batch write	Main	1.35 msec	0.76 msec				
			Sub	1.53 msec	0.73 msec				
	Com-ment	Batch read		1.35 msec	0.76 msec	2.42 msec	256 bytes	128 bytes	(Specified numbers/128) Round off to the nearest decimal point. + 1 scan (Max.3 scans)
		Batch write		1.53 msec	0.73 msec	2.60 msec			
	Exten-sion com-ment	Batch read		—	—	2.31 msec	256 bytes	128 bytes	(Specified numbers/128) + 1 scan (Max.3 scans)
		Batch write		—	—	2.59 msec			
	Para-meter	Batch read		0.68 msec	0.50 msec	2.42 msec	256 bytes	128 bytes	(Specified numbers/128) Round off to the nearest decimal point. + 1 scan (Max.3 scans)
		Batch write		—	—	—			
Analyze request		—	—	—					
PC CPU	Remote RUN		—	—	—	—	—	—	
	Remote STOP		—	—	—	—	—		
	Read for individual PC		—	—	—	—	—	1 scan	

POINTS

- (1) The PC CPU processes any one of the above operations for each END. So, if the A6GPP and AJ71E71 access the PC CPU simultaneously, one operation is suspended until the other one is completed. In this case, the scan time for processing could be longer.
- (2) Even if the PC CPU is not linked to the AJ71E71, the scan time would remain approximately 0.2 msec longer (for an A3H, A2A, or A3ACPU, 0.1 msec longer).

APPENDIX 2. ASCII CODE TABLE

MSD \ LSD		0	1	2	3	4	5	6	7
		000	001	010	011	100	101	110	111
0	0000	NUL	DLE	SP	0	@	P	à	p
1	0001	SOH	DC1	!	1	A	Q	á	q
2	0010	STX	DC2	!!	2	B	R	â	r
3	0011	ETX	DC3	#	3	C	S	ã	s
4	0100	EOT	DC4	\$	4	D	T	ä	t
5	0101	ENQ	NAK	%	5	E	U	å	u
6	0110	ACK	SYN	&	6	F	V	f	v
7	0111	BEL	ETB	/	7	G	W	g	w
8	1000	BS	CAN	(8	H	X	h	x
9	1001	HT	EM)	9	I	Y	i	y
A	1010	LF	SUB	*	:	J	Z	j	z
B	1011	VT	ESC	+	;	K	[k	{
C	1100	FF	FS	,	<	L	\	l	
D	1101	CR	GS	-	=	M]	m	}
E	1110	SO	RS	.	>	N	^	n	~
F	1111	SI	VS	/	?	O	_	o	DEL

APPENDIX 3. REFERENCE

The "DDN Protocol Handbook" (a three-volume set) gives details on the TCP/IP.

Publisher:

DDN Network Information Center

SRI International

333 Ravenswood Avenue, EJ291

Menlo Park, California 94025

RFC Numbers:

TCP RFC793

UDP RFC768

IP RFC791

ICMP RFC792

ARP RFC826

APPENDIX 4 EXTERNAL VIEW

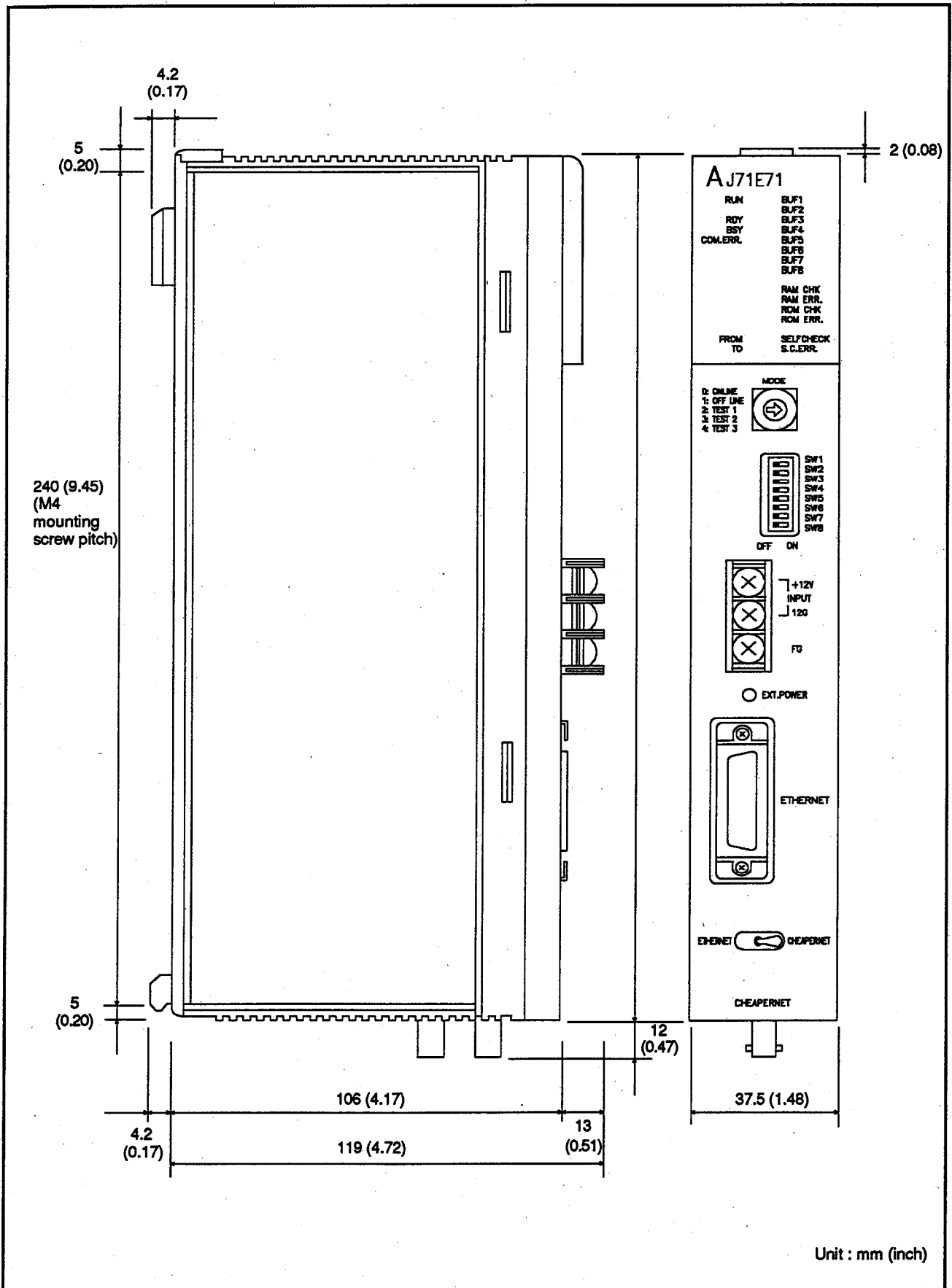

Unit : mm (inch)

APPENDIX 5 SAMPLE PROGRAMS

This sample program is used to perform a connection test on the connection between the AJ71E71 and the PC/AT.

This program is presented as an example; it accesses the data registers (D) and extension file registers (R) of the ACPU installed with the AJ71E71 and reads the random buffer of the AJ71E71.

(1) Access range

Data registers: D100 to D121

Extension file registers: Block No.1 (R10 to R20)

Random buffer reading: Addresses 100 to 121

(2) Modification method

By modifying E71INC.H, it is possible to access other stations and other devices.

< Changing devices >

The devices to be accessed are set at the "D_TYPEL" and "D_TYPEH" device code entries.

To access data registers (D), set the entries to D_TYPEH, D_TYPEL = 44H, 20H.

To access link registers (W), set the entries to D_TYPEH, D_TYPEL = 57H, 20H.

For other devices, see section 8.4.1.

< Changing device numbers >

The head device number is set at the "D_NO" entry.

In this program the setting is D_NO = 100.

< Changing PC numbers >

The communication destination ACPU is set at the "PC_NO" entry.

Self station: PC_NO = FF, Other station: PC_NO = station number

< Changing the extension file register block number >

The extension file register block number is set at the "R_BLOCKL" and "D_TYPEH" entries.

In this program the setting is for block number 1.

< Number of communications >

The number of communications with the AJ71E71 is set at the "ACLOOP" entry.

In this program the setting is "ACLOOP" = 10.

< Changing the port number & IP address >

The PC/AT port number and IP address is set at the "MY_PORT" and "MY_IP" entries.

The AJ71E71 port number and IP address is set at the "DST_PORT" and "DST_IP" entries.

When a PC/AT is added to an existing Ethernet system, its port number and IP address must be set in accordance with the system. Confirmation of the port number and IP address must be obtained from the "super user" (network manager).

(3) Sequence program

An example sequence program for the ACPU installed with the communicating AJ71E71 is shown below.

This program does only the bare minimum. For details on action to take in the event of errors etc., see Chapter 5.

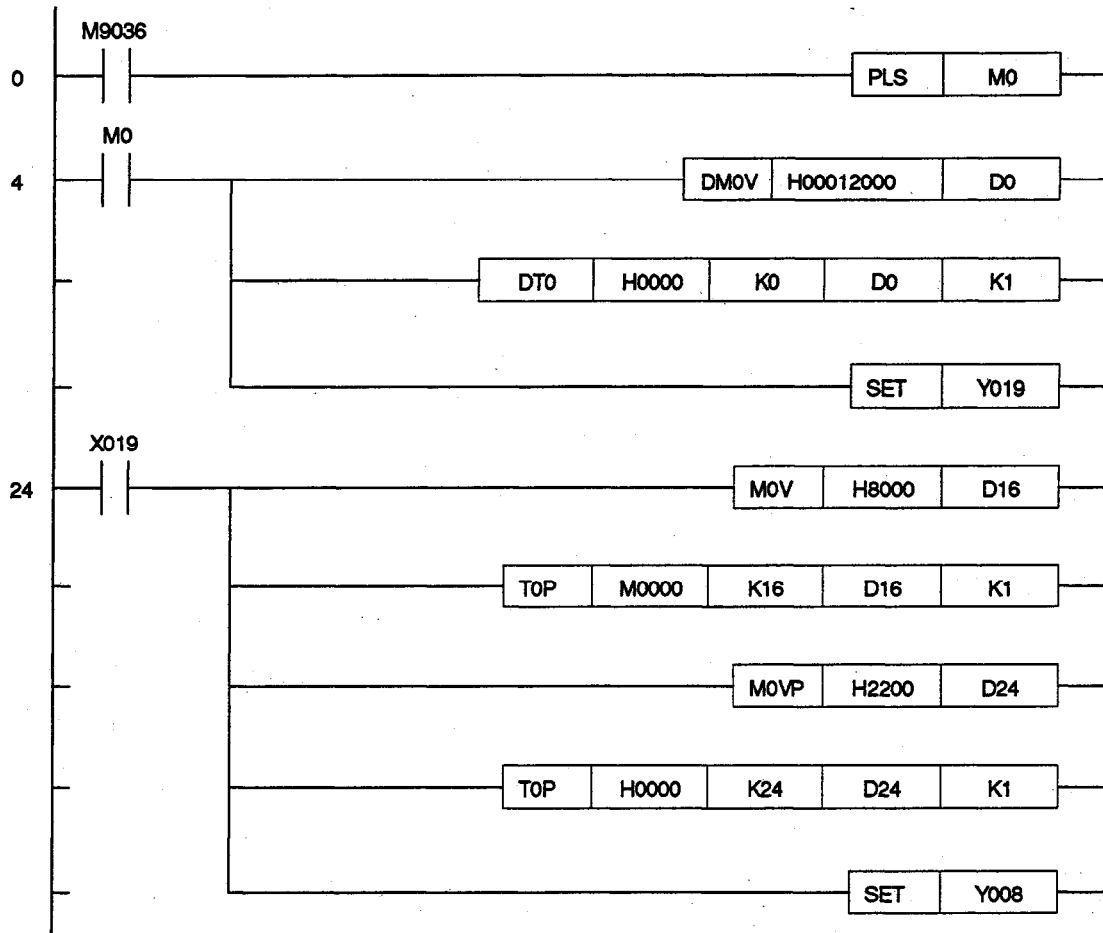

(4) Header file (E71INC.H)

```

/* **** */
/* *   Definition for AJ71E71                               */
/* *   By modifying E71INC.H, it is possible to access other stations */
/* *   and other devices.                                   */
/* *   Date 01/07/93                                       */
/* *   Copyright (C) 1991 Mitsubishi Electric Corporation */
/* *   All Rights Reserved                                  */
/* **** */
/* *   < Program modify list>                               */
/* **** */
/* *   Port number, IP address                             */
/* **** */
#define MY_PORT      0x2000    /* soure port */
#define MY_IP        0x11000   /* my IP address */
#define DST_PORT     0x2200    /* destination port */
#define DST_IP       0x12000   /* destination IP address */

/* **** */
/* *   The number of times AJ71E71 is accessed is set at   */
/* **** */
#define ACTLOOP      10        /* access count to ACPU */

/* **** */
/* *   If the communication destination ACPU is at the self station, FF */
/* *   is set at PC_NO; if it is another station, the relevant station num- */
/* *   ber is set at PC_NO.                                       */
/* *   The device type to be accessed is set at D_TYPEL and D_TYPEH. */
/* *   The extension file register block number is set at R_BLOCKL and */
/* *   D_TYPEH.                                                   */
/* *   The head address to be accessed is set at D_NO.         */
/* **** */
#define PC_NO        0xff      /* PLC station No. */
#define D_NO         100      /* device No. */
#define D_TYPEL      0x20     /* device type (L) D */
#define D_TYPEH      0x44     /* device type (H) D */
#define R_TYPEL      0x20     /* device type (L) R */
#define R_TYPEH      0x52     /* device type (H) R */
#define R_BLOCKL     0x01     /* R device block (L) */
#define R_BLOCKH     0x00     /* R device block (H) */

```

```
/* **** */
/* *   Data for AJ71E71   */
/* **** */

#define      E71RD      0x01      /* sub_header "Word batch Read" */
#define      E71WR      0x03      /* sub_header "Word batch Write" */
#define      E71R_RD    0x17      /* sub_header "Word batch Read R" */
#define      E71R_WR    0x18      /* sub_header "Word batch Write R" */
#define      E71RM_RD   0x61      /* sub_header random access read_out */
#define      E71RM_WR   0x62      /* sub_header random access write_out */

#define      ACCRLOOP   30000     /* data access count */
#define      A_TIMEL    0x02     /* ACPU supervising time (L) * 500ms */
#define      A_TIMEH    0x00     /* ACPU supervising time (H) * 500ms */
#define      DWORDW_MAX 253      /* dwordw takes number */
#define      ADDR_MAX   1792     /* devices takes number */
```

(5) Sample program

```

/* **** */
/* *   AJ71E71 sample program                               */
/* *   This sample program is used to perform a connection test */
/* *   on the connection between the AJ71E71 and the PC/AT.    */
/* *   This program is presented as an example; it accesses the */
/* *   data registers (D) and extension file registers (R) of the */
/* *   ACPU installed with the AJ71E71 and reads the random    */
/* *   buffer of the AJ71E71 unit.                               */
/* *   It is possible to access other stations and other devices by */
/* *   modifying the E71INC.H.                                   */
/* *   Date 01/07/93                                           */
/* *   Copyright (C) 1991 Mitsubishi Electric Corporation      */
/* *   All Rights Reserved                                     */
/* **** */
/* *   < Program modify list >                                */
/* **** */

# include < stdio.h>
# include < ctype.h>
# include < conio.h>
# include < io.h>
# include < fcntl.h>

# include "socket.h"
# include "e71inc.h"                                     /* Definition for AJ71E71 */

char name_0[ ] = "ACPUAAA";

char sdata [2048], resp_data [4096];
int      s [1];
struct sckidtbl sk [1], *scktbl;
int      scktbl_len;
struct sockaddr sa [1], *saddr;
struct host_type h_typ;

int      init ( );
int      socket ( );
int      connect ( );
int      term ( );
int      shutdown ( );
int      send ( );
int      recv ( );
void     cursor ( );
void     cls ( );

```

```

/* ***** */
/* *      Main program (initial display)          * */
/* ***** */
void main ( )
{
    int    sub_main ( );
    int    id, sts;

    cls ( );
    cursor (2,20);
    printf ("< < Ethernet test/General data processing> > \n");

    cursor (3,1);
    printf ("Board statuses\n");
    cursor (6,1);
    printf ("D_reg Access\n");
    cursor (11,1);
    printf ("R_reg access\n");
    cursor (16,1);
    printf ("Random access\n");
    cursor (22,1);
    printf ("Error message\n");
    cursor (5,20);
    printf ("returned at the main, %x\n", sub_main ( ));
    exit (0);
}

/* ***** */
/* *      Subprogram                              * */
/* ***** */
int    sub_main ( )
{
    int    dreg_wr ( );
    int    rreg_wr ( );

    int    dwordw;
    int    addr= D_NO;          /* Head address setting */
    int    accr = 0;
    int    err_p;
    int    shutf = 1;
    int    retv;

    sa [0] .sa_family   = SOCK_STREAM;
    sa [0] .sa_port     = MY_PORT;
    sa [0] .dst_port    = DST_PORT;
    sa [0] .dst_ip      = DST_IP;
    sa [0] .e_addr [6] = 0x00;
}

```

```

h_typ.host_name [16] = 0x00;
h_typ.lp_addr      = MY_IP;
h_typ.e_addr [6]  = 0x00;

saddr = sa;

/* === board initialization === */
if (init (&err_p) != 0)      /* Initialization of Ethernet board */
{
    cursor (22,20);
    printf ("Initialization error %x\n",err_p);
    return (-1);
}
cursor (3,20);
printf ("Init sucess.\n");

/* === socket entry === */
s[0] = socket (saddr, name_0, sizeof (name_0), &err_p);
/* "s" is the registered socket ID number */
if (s [0] = -1)
{
    cursor (22,20);
    printf ("Socket entry err. s1_1, err code %x\n",err_p);
    return (-1);
}

/* === Connection === */
scktbl = sk; /* Make connection with AJ71E71 (passive state) */
/* Data register access */
if (connect (s [0], scktbl,&scktbl_len,&err_p) != 0)
    return (err_p);
cursor (3,20);
printf ("Cnctd %x, %x, %s, %x, %x, %lx\n",
        scktbl-> id,scktbl-> lcn,scktbl-> rmt_name,
        scktbl-> local_prt, scktbl-> remote_prt,scktbl-> remote_ip);

/* === communication start === */
dwordw = 1;
for (accr= 0;accr< ACTLOOP;+ + accr)
{
    if (accr == ACCRLOOP)
        accr = 0;
    cursor (8,20);
    printf ("                                \n")
    cursor (9,20);
    printf ("                                \n")

/* === Data_register access === */
if (dreg_wr (dwordw, accr, addr) == -1)
/* Data register access */

```



```

        break;
        cursor (13,20);
        printf ("                                \n");
        cursor (14,20);
        printf ("                                \n");

/* === File_register access === */
        if (rreg_wr (dwordw,accr, addr) == -1)
                                                    /* Extension file register access */
                break;
        cursor (18,20);
        printf ("                                \n");

/* === AJ71E71 random_buffer access === */
        if (randm_buf (512, addr) == -1) /* AJ71E71 random buffer */
                break;

        ++ dwordw;
        ++ addr;
        if (dwordw == DWORDW_MAX) /* Number of data items accessed */
                dwordw = 1;
        if (addr == ADDR_MAX) /* Head device address */
                addr = 0;
    }
    printf ("Accr %d\n",accr);

/* === communication end === */
    while (shutf != 0)
    {
        shutf = shutdown (s [0], 1,&err_p); /* Disconnection */
        if ( (shutf == -1)& (err_p != 0x0a) )
        {
            printf ("shutdown err code %x\n",err_p);
            shutf = 0;
        }
    }
    cursor (6,20);
    printf ("Shutdown %d ",s [0]);

    if (term (&err_p) == -1 /* Termination of Ethernet board */
        {
            printf ("termination err %x\n",err_p);
            return (-1);
        }

    printf ("Terminated\n");
    cursor (22,1);
    return (0);

```

```

/* ***** */
/* *   Data Register Access Program   * */
/* ***** */
/* = = = = Data register access = = = = */
int    dreg_wr (dwordw, accr, addr)
int    dwordw, accr, addr;
{
    extern char sdata [2048], resp_data [4096];
    extern int s [1];

    void    data_gen ();
    void    devide ();
    int     retv;
    char    dveded_data [2];

    data_gen (dwordw, 18, accr); /* Creation of write data */
    sdata [0] = E71WR;           /* Subheader: device batch write */
    sdata [1] = PC_NO;           /* PC number */
    sdata [2] = A_TIMEL;        /* ACPU monitor timer */
    sdata [3] = A_TIMEH;

    devide (addr, dveded_data);
    sdata [4] = dveded_data [0]; /* Head device number */
    sdata [5] = dveded_data [1];
    sdata [6] = 0x00;
    sdata [7] = 0x00;
    sdata [8] = D_TYPEL;        /* Device code */
    sdata [9] = D_TYPEH;

    devide (dwordw+ 3, dveded_data);
    sdata [10] = dveded_data [0]; /* Number of device points */
    sdata [11] = 0x00;
    sdata [12] = 0x03;          /* Write data 1 */
    sdata [13] = 0x00;
    sdata [14] = 0x02;          /* Write data 2 */
    sdata [15] = 0x00;
    devide (accr, dveded_data);
    sdata [16] = dveded_data [0]; /* Write data 3 */
    sdata [17] = dveded_data [1];

/* = = = = data writing into data reg.acpu = = = = */
    cursor (6,20);
    printf ("DATA REG. Counter = %6d, Address = %6d /", accr, addr);
    retv = data_send (s [0], dwordw+ 9); /* Device write */
    if (retv == -1)
        return (-1);
    cursor (8,20);
    printf ("%4d b WR com. sent\n",retv);
    rev = 0;
}

```

```

retv = rcv_resp (s [0], 1); /* AJ71E71 response receive */
if (retv == -1)
    return (-1);

cursor (9,20);
printf ("%4d b WR resp.rcvd\n",retv);

sdata [0] = E71RD; /* Subheader: device batch read */
retv = data_send (s [0], 6); /* Read request */
if (retv == -1)
    return (-1);

cursor (8,42);
printf ("%4d b RD com.sent\n",retv);
retv = rcv_resp (s [0],dwordw+ 4); /* Device read */
if (retv == -1)
    return (-1);
cursor (9,42);
printf ("%4d b RD resp.revd\n",retv);
retv = data_cmp (& (sdata [18], & (resp_data [8]),dwordw);
/* Data comparison */
if (retv != 0)
{
    cursor (22,20);
    printf ("Data comp err D_reg head= %d, offset = %d, WR = %d, RD
= %d\n",addr+ 0x400, retv, sdata [18+ retv], resp_data [8+ retv]);
    return (-1);
}
cursor (9,64);
printf ("Data compared\n");
return (0); /* normal end */
}

/* ***** */
/* * Extension File Register Access Program * */
/* ***** */
/* === file register access === */
rreg_wr (dwordw, accr, addr)
int dwordw, accr, addr;
{
    int retv;
    char dvedd_data [2];

extern char sdata [2048], resp_data [4096];
extern int s [1];
void data_gen ();
void devide ();

data_gen (dwordw, 20, accr+ 0x100); /* Creation of write data */
sdata [0] = E71R_WR; /* Subheader: extension file register batch write */

```

```

sdata [1] = PC_NO;           /* PC number */
sdata [2] = A_TIMEL;        /* ACPU monitoring time */
sdata [3] = A_TIMEH;

devide (addr, dveded_data);
sdata [4] = dveded_data [0]; /* Head device number */
sdata [5] = dveded_data [1];
sdata [6] = 0x00;
sdata [7] = 0x00;
sdata [8] = R_TYPEL;        /* Device code */
sdata [9] = R_TYPEH;
sdata [10] = R_BLOCKL;     /* Block No. */
sdata [11] = R_BLOCKH;

devide (dwordw+ 3, dveded_data);
sdata [12] = dveded_data [0]; /* Number of device points */
sdata [13] = 0x00;
sdata [14] = 0x03;         /* Write data 1 */
sdata [15] = 0x00;
sdata [16] = 0x02;         /* Write data 2 */
sdata [17] = 0x00;
devide (accr, dveded_data); /* Write data 3 */
sdata [18] = dveded_data [0];
sdata [19] = dveded_data [1];

/* === data writing into file register in block 1 === */
cursor (11,20);
printf ("FILE REG. Counter= %6d, Address = %6d / ",accr, addr);
retv = data_send (s [0], dwordw+ 10); /* Extension file register write */
if (retv == -1)
    return (-1);
cursor (13, 20);
printf ("%4d b WR comm.sent\n",retv);
retv = 0;
retv = rcv_resp (s [0], 1); /* AJ71E71 response receive */
if (retv == -1)
    return (-1);
cursor (14,20);
printf ("%4d b WR resp.rcdvd\n",retv);

sdata [0] = E71R_RD; /* Subheader: extension file register batch read */
sdata [1] = PC_NO;
retv = data_send (s [0], 7); /* Read request */
if (retv == -1)
    return (-1);
cursor (13, 42);
printf ("%4d b RD com.sent\n",retv);
retv = rcv_resp (s [0],dwordw+ 4);/* Extension file register read */
if (retv == -1)

```

```

        return (-1);
    cursor (14,42);
    printf ("%4d b RD resp.rcvd\n",retv);
    retv= data_cmp(&(sdata[20]),&(resp_data[8]),dwordw);/* Data comparison */
    if (retv != 0)
    {
        cursor (22,20);
        printf ("Data comp ef, F_reg head = %d, offset= %d, WR = %d, RD =
%d\n",addr,retv, sdata [20+ retv],resp_data [8+ retv]);
        return (-1);
    }
    cursor (14,64);
    printf ("Data compared \n");
    return (0);
}

/* ***** */
/* *    AJ71E71 Random Buffer Access    * */
/* ***** */

/* === random buffer access === */
int    randm_buf (bwordw, addr)
int    addr;
int    bwordw;
{
    extern char sdata [2048];
    extern char resp_data [4096];
    extern int s [1];

    int    retv;
    char    dvided_data [4];

    cursor (16,20);
    printf ("Read addr = %4d \n ", addr);
    sdata [0] = E71RM_RD;          /* Subheader: random buffer read */
    sdata [1] = 0x00;
    devide (addr, dvided_data);
    sdata [2] = dvided_data [0];    /* Head buffer address */
    sdata [3] = dvided_data [1];
    devide (bwordw, dvided_data);
    sdata [4] = dvided_data [0];    /* Number of words to read */
    sdata [5] = dvided_data [1];
    retv = data_send (s [0], 3);    /* Read request */
    if (retv == -1)
        return (-1);
    cursor (18,20);
    printf ("%4d byte data sent\n",retv);

    retv = rcv_resp (s [0], bwordw + 1);    /* Random buffer read */
}

```

```

    if (retv == -1)
        return (-1);
    if ( (resp_data [0] != 0xe1) || (resp_data [1] != 0x00))
    {
        cursor (22,20);
        printf ("Bad response %x, %x rcvd\n", resp_data [0],
            resp_data [1]);
        return (-1);
    }
    cursor (18,42);
    printf ("%4d byte resp.rcvd\n",retv);
    return (0);          /* normal end */
}

/* .....*\
/* *   Data Send Program                               * *\
/* .....*\
/* === data send function === */
int    data_send (dst_sk,wordw)
int    dst_sk;          /* socket ID */
int    wordw;          /* data length in word */
{
    extern char sdata [2048];

    int    sendf;
    int    err_p;
    int    j= 0;
    int    cmpltf = 0;
    int    sendw = 0;
    int    ptr= 0;
    int    bytew;

    bytew = wordw + wordw;
    while (cmpltf == 0)
    {
        sendf= send (dst_sk,& (sdata [ptr]),bytew,&err_p);
            /* TCP data send */
        sendw = sendw + sendf;
        if (sendf < 0)
        {
            cursor (22,20);
            printf ("Data send err to %d, error code %x\n",dst_sk,err_p);
            cmpltf = 1;
            return (-1);
        }
        else if (sendf < bytew)
        {
            ptr = sendw;
            bytew = bytew - sendf;
        }
    }
}

```

```

        if (ptr > 526)
            return (-1);
        if (++j > 10)
        {
            cursor (22,20);
            printf ("TIME OVER\n");
            return (-1);
        }
    }
else if (sendf == bytew)
    {
        cmpltf = 1;
        return (sendw);
    }
else
    {
        cmpltf = 1;
        reutrn (-1);
    }
}
}

/* ***** */
/* *   AJ71E71 Response Receive Program   * */
/* ***** */
/* === response receive function === */
int    rcv_resp (dst_sk, wordw)
int    dst_sk;          /* socket ID, data length */
int    wordw;
{
    extern char resp_data [4096];

    int    err_p, rcvf, temp;
    int    l = 0;
    int    j;
    int    bytew;
    int    cmpltf = 0;
    int    ptr = 0;
    int    rcvdw = 0;

    bytew = wordw + wordw;
    rcvf = 0;
    while (cmpltf == 0)
    {
        rcvf= recv (dst_sk,& (resp_data [ptr]), bytew+ 1026, &err_p);
        /* TCP data receive */

        rcvdw = rcvdw + rcvf;
        if (rcvf < 0)

```

```

        {
            cursor (22,20);
            printf ("Response rcv err frm %d, err code %x\n",dst_sk,err_p);
            cmpltf= 1;
            return (-1);
        }
    else if (rcvf < bytew)
    {
        ptr = rcvdw;
        bytew = bytew - rcvf;
        if (ptr > 526)
            return (-1);
        if (++i > 32000)
        {
            cursor (22,20);
            printf ("TIME OUT\n");
            return (-1);
        }
    }
    else if (rcvf == bytew)
    {
        cmpltf = 1;
        return (rcvdw);
    }
    else
    {
        cursor (22, 20);
        printf ("&&&&Too many resp. rcvd, exp = %d, actual = %d,
rcvf = %d&&&&\n", bytew, rcvdw, rcvf);
        temp = rcvf - bytew;
        if ((resp_data [0] == resp_data [temp])&& (resp_data [1] ==
resp_data [temp + 1]))
        {
            for (i= 0;i< bytew;++ i)
                sresp_data [i] = resp_data [i+ temp];
            rcvdw= rcvdw - temp;
            return (rcvdw);
        }
        cmpltf = 1;
        return (-1);
    }
}
}

```



```

/* ***** */
/* *   Send Data/Receive Data Comparison Program   * */
/* ***** */
/* === data comparison function === */
int    data_cmp (sdata_ptr,rdata_ptr,wordw)
int    wordw;
char   *sdata_ptr;
char   *rdata_ptr;
{

    int i= 0;
    char data;
    int bytew;

    bytew = wordw + wordw;
    data = *sdata_ptr;
    for (i;i< bytew;++ i)
        {
            if (data != *rdata_ptr)
                break;
            ++ data;
            ++ rdata_ptr;
        }
    if (i != bytew)
        {
            if (i == 0)
                return (-1);
            else
                return (i);
        }
    else
        return (0);
}

/* === data generator === */
void    data_gen(wordw, ptr, f_dat)
int     wordw, f_dat;
int     ptr;
{
    int     i= 0;
    char    j = 0;
    char    data;
    int     bytew;

    data = (char)f_dat;
    bytew = wordw + wordw;
    if (wordw <= 253)
        {

```

```
        for (i= 0;i< bytew;++ i)
            {
                sdata [ptr+ i] = data + j;
                ++ j;
            }
    }

void  devide (in_data,out_data_ptr)
int   in_data;
char  *out_data_ptr;
{
    int temp;

    temp = in_data & 0xff;
    *out_data_ptr = (char) temp;
    ++ out_data_ptr;
    temp = in_data >> 8 & 0xff;
    *out_data_ptr = (char) temp;
}

void  cls ( )
{
    printf ("\x1b [2J");
}

void  cursor (pl,pc)
char  pl,pc;
{
    printf ("\x1b [%d;%dH",pl,pc);
}
}
```

IMPORTANT

- (1) Design the configuration of a system to provide an external protective or safety interlocking circuit for the PCs.
- (2) The components on the printed circuit boards will be damaged by static electricity, so avoid handling them directly. If it is necessary to handle them take the following precautions.
 - (a) Ground human body and work bench.
 - (b) Do not touch the conductive areas of the printed circuit board and its electrical parts with and non-grounded tools etc.

Under no circumstances will Mitsubishi Electric be liable or responsible for any consequential damage that may arise as a result of the installation or use of this equipment.

All examples and diagrams shown in this manual are intended only as an aid to understanding the text, not to guarantee operation. Mitsubishi Electric will accept no responsibility for actual use of the product based on these illustrative examples.

Owing to the very great variety in possible applications of this equipment, you must satisfy yourself as to its suitability for your specific application.

HEADQUARTERS

MITSUBISHI ELECTRIC EUROPE B.V. **EUROPE**
 German Branch
 Gothaer Straße 8
D-40880 Ratingen
 Phone: +49 (0)2102 / 486-0
 Fax: +49 (0)2102 / 486-1120

MITSUBISHI ELECTRIC EUROPE B.V.-org.sl. **CZECH REP.**
 Czech Branch
 Avenir Business Park, Radlická 714/113a
CZ-158 00 Praha 5
 Phone: +420 - 251 551 470
 Fax: +420 - 251-551-471

MITSUBISHI ELECTRIC EUROPE B.V. **FRANCE**
 French Branch
 25, Boulevard des Bouvets
F-92741 Nanterre Cedex
 Phone: +33 (0)1 / 55 68 55 68
 Fax: +33 (0)1 / 55 68 57 57

MITSUBISHI ELECTRIC EUROPE B.V. **IRELAND**
 Irish Branch
 Westgate Business Park, Ballymount
IRL-Dublin 24
 Phone: +353 (0)1 4198800
 Fax: +353 (0)1 4198890

MITSUBISHI ELECTRIC EUROPE B.V. **ITALY**
 Italian Branch
 Viale Colleoni 7
I-20041 Agrate Brianza (MB)
 Phone: +39 039 / 60 53 1
 Fax: +39 039 / 60 53 312

MITSUBISHI ELECTRIC EUROPE B.V. **POLAND**
 Poland Branch
 Krakowska 50
PL-32-083 Balice
 Phone: +48 (0)12 / 630 47 00
 Fax: +48 (0)12 / 630 47 01

MITSUBISHI ELECTRIC EUROPE B.V. **RUSSIA**
 52, bid. 3 Kosmodamianskaya nab 8 floor
RU-115054 Moscow
 Phone: +7 495 721-2070
 Fax: +7 495 721-2071

MITSUBISHI ELECTRIC EUROPE B.V. **SPAIN**
 Spanish Branch
 Carretera de Rubí 76-80
E-08190 Sant Cugat del Vallés (Barcelona)
 Phone: 902 131121 // +34 935653131
 Fax: +34 935891579

MITSUBISHI ELECTRIC EUROPE B.V. **UK**
 UK Branch
 Travellers Lane
UK-Hatfield, Herts. AL10 8XB
 Phone: +44 (0)1707 / 27 61 00
 Fax: +44 (0)1707 / 27 86 95

MITSUBISHI ELECTRIC CORPORATION **JAPAN**
 Office Tower "Z" 14 F
 8-12,1 chome, Harumi Chuo-Ku
Tokyo 104-6212
 Phone: +81 3 622 160 60
 Fax: +81 3 622 160 75

MITSUBISHI ELECTRIC AUTOMATION, Inc. **USA**
 500 Corporate Woods Parkway
Vernon Hills, IL 60061
 Phone: +1 847 478 21 00
 Fax: +1 847 478 22 53

EUROPEAN REPRESENTATIVES

GEVA **AUSTRIA**
 Wiener Straße 89
AT-2500 Baden
 Phone: +43 (0)2252 / 85 55 20
 Fax: +43 (0)2252 / 488 60

TEHNIKON **BELARUS**
 Oktyabrskaya 16/5, Off. 703-711
BY-220030 Minsk
 Phone: +375 (0)17 / 210 46 26
 Fax: +375 (0)17 / 210 46 26

ESCO DRIVES & AUTOMATION **BELGIUM**
 Culliganlaan 3
BE-1831 Diegem
 Phone: +32 (0)2 / 717 64 30
 Fax: +32 (0)2 / 717 64 31

Koning & Hartman b.v. **BELGIUM**
 Woluwelaan 31
BE-1800 Vilvoorde
 Phone: +32 (0)2 / 257 02 40
 Fax: +32 (0)2 / 257 02 49

INEA BH d.o.o. **BOSNIA AND HERZEGOVINA**
 Aleja Lipa 56
BA-71000 Sarajevo
 Phone: +387 (0)33 / 921 164
 Fax: +387 (0)33 / 524 539

AKHNATON **BULGARIA**
 4 Andrej Ljapchev Blvd. Pb 21
BG-1756 Sofia
 Phone: +359 (0)2 / 817 6044
 Fax: +359 (0)2 / 97 44 06 1

INEA CR d.o.o. **CROATIA**
 Losinjska 4 a
HR-10000 Zagreb
 Phone: +385 (0)1 / 36 940 -01 / -02 / -03
 Fax: +385 (0)1 / 36 940 -03

AutoCont C.S. s.r.o. **CZECH REPUBLIC**
 Technologická 374/6
CZ-708 00 Ostrava-Pustkovce
 Phone: +420 595 691 150
 Fax: +420 595 691 199

Beijer Electronics A/S **DENMARK**
 Lykkegårdsvej 17
DK-4000 Roskilde
 Phone: +45 (0)46 / 75 76 66
 Fax: +45 (0)46 / 75 56 26

Beijer Electronics Eesti OÜ **ESTONIA**
 Pärnu mnt.160i
EE-11317 Tallinn
 Phone: +372 (0)6 / 51 81 40
 Fax: +372 (0)6 / 51 81 49

Beijer Electronics OY **FINLAND**
 Peltoie 37
FIN-28400 Ulvila
 Phone: +358 (0)207 / 463 540
 Fax: +358 (0)207 / 463 541

UTEKO **GREECE**
 5, Mavrogenous Str.
GR-18542 Piraeus
 Phone: +30 211 / 1206 900
 Fax: +30 211 / 1206 999

MELTRADE Kft. **HUNGARY**
 Fertő utca 14.
HU-1107 Budapest
 Phone: +36 (0)1 / 431-9726
 Fax: +36 (0)1 / 431-9727

Beijer Electronics SIA **LATVIA**
 Rītausmas iela 23
LV-1058 Rīga
 Phone: +371 (0)784 / 2280
 Fax: +371 (0)784 / 2281

Beijer Electronics UAB **LITHUANIA**
 Savanorių Pr. 187
LT-02300 Vilnius
 Phone: +370 (0)5 / 232 3101
 Fax: +370 (0)5 / 232 2980

EUROPEAN REPRESENTATIVES

ALFATRADE Ltd. **MALTA**
 99, Paola Hill
Malta- Paola PLA 1702
 Phone: +356 (0)21 / 697 816
 Fax: +356 (0)21 / 697 817

INTEHSIS srl **MOLDOVA**
 bld. Traian 23/1
MD-2060 Kishinev
 Phone: +373 (0)22 / 66 4242
 Fax: +373 (0)22 / 66 4280

HIFLEX AUTOM.TECHNIEK B.V. **NETHERLANDS**
 Wolweverstraat 22
NL-2984 CD Ridderkerk
 Phone: +31 (0)180 - 46 60 04
 Fax: +31 (0)180 - 44 23 55

Koning & Hartman b.v. **NETHERLANDS**
 Haarderbergweg 21-23
NL-1101 CH Amsterdam
 Phone: +31 (0)20 / 587 76 00
 Fax: +31 (0)20 / 587 76 05

Beijer Electronics AS **NORWAY**
 Postboks 487
NO-3002 Drammen
 Phone: +47 (0)32 / 24 30 00
 Fax: +47 (0)32 / 84 85 77

Fonseca S.A. **PORTUGAL**
 R. João Francisco do Casal 87/89
PT - 3801-997 Aveiro, Esgueira
 Phone: +351 (0)234 / 303 900
 Fax: +351 (0)234 / 303 910

Sirius Trading & Services srl **ROMANIA**
 Aleea Lacul Morii Nr. 3
RO-060841 Bucuresti, Sector 6
 Phone: +40 (0)21 / 430 40 06
 Fax: +40 (0)21 / 430 40 02

Craft Con. & Engineering d.o.o. **SERBIA**
 Bulevar Svetog Cara Konstantina 80-86
SER-18106 Nis
 Phone: +381 (0)18 / 292-24-4/5
 Fax: +381 (0)18 / 292-24-4/5

INEA SR d.o.o. **SERBIA**
 Izletnicka 10
SER-113000 Smederevo
 Phone: +381 (0)26 / 617 163
 Fax: +381 (0)26 / 617 163

SIMAP s.r.o. **SLOVAKIA**
 Jána Derku 1671
SK-911 01 Trenčín
 Phone: +421 (0)32 743 04 72
 Fax: +421 (0)32 743 75 20

PROCONT, spol. s r.o. Prešov **SLOVAKIA**
 Kúpeľná 1/A
SK-080 01 Prešov
 Phone: +421 (0)51 7580 611
 Fax: +421 (0)51 7580 650

INEA d.o.o. **SLOVENIA**
 Stegne 11
SI-1000 Ljubljana
 Phone: +386 (0)1 / 513 8100
 Fax: +386 (0)1 / 513 8170

Beijer Electronics AB **SWEDEN**
 Box 426
SE-20124 Malmö
 Phone: +46 (0)40 / 35 86 00
 Fax: +46 (0)40 / 93 23 01

Omni Ray AG **SWITZERLAND**
 Im Schörlí 5
CH-8600 Dübendorf
 Phone: +41 (0)44 / 802 28 80
 Fax: +41 (0)44 / 802 28 28

GTS **TURKEY**
 Bayraktar Bulvarı Nutuk Sok. No:5
TR-34775 Yukarı Dudullu-Ümraniye-İSTANBUL
 Phone: +90 (0)216 526 39 90
 Fax: +90 (0)216 526 39 95

CSC Automation Ltd. **UKRAINE**
 4-B, M. Raskovoyi St.
UA-02660 Kiev
 Phone: +380 (0)44 / 494 33 55
 Fax: +380 (0)44 / 494-33-66

EURASIAN REPRESENTATIVES

Kazpromautomatiks Ltd. **KAZAKHSTAN**
 Mustafina Str. 7/2
KAZ-470046 Karaganda
 Phone: +7 7212 / 50 11 50
 Fax: +7 7212 / 50 11 50

MIDDLE EAST REPRESENTATIVES

ILAN & GAVISH Ltd. **ISRAEL**
 24 Shenkar St., Kiryat Arie
IL-49001 Petah-Tiqva
 Phone: +972 (0)3 / 922 18 24
 Fax: +972 (0)3 / 924 0761

TEXEL ELECTRONICS Ltd. **ISRAEL**
 2 Ha'umanut, P.O.B. 6272
IL-42160 Netanya
 Phone: +972 (0)9 / 863 39 80
 Fax: +972 (0)9 / 885 24 30

CEG INTERNATIONAL **LEBANON**
 Cebaco Center/Block A Autostrade DORA
Lebanon - Beirut
 Phone: +961 (0)1 / 240 430
 Fax: +961 (0)1 / 240 438

AFRICAN REPRESENTATIVE

CBI Ltd. **SOUTH AFRICA**
 Private Bag 2016
ZA-1600 Isando
 Phone: +27 (0)11 / 977 0770
 Fax: +27 (0)11 / 977 0761