

**MITSUBISHI** *Changes for the Better*  
 PROGRAMMABLE CONTROLLERS  
 MELSEC-F

**FX3U-4AD-PTW-ADP**

**USER'S MANUAL**

Manual Number	JY997D29101
Revision	A
Date	December 2007

This manual describes the part names, dimensions, mounting, and specifications of the product. Before use, read this manual and the manuals of all relevant products fully to acquire proficiency in handling and operating the product. Make sure to learn all the product information, safety information, and precautions. Store this manual in a safe place so that it can be taken out and read whenever necessary. Always forward it to the end user. Registration: The company and product names described in this manual are registered trademarks or the trademarks of their respective companies. Effective December 2007. Specifications are subject to change without notice. © 2007 Mitsubishi Electric Corporation

**Safety Precaution** (Read these precautions before use.)

This manual classifies the safety precautions into two categories:

**⚠ DANGER** and **⚠ CAUTION**.

<b>⚠ DANGER</b>	Indicates that incorrect handling may cause hazardous conditions, resulting in death or severe injury.
<b>⚠ CAUTION</b>	Indicates that incorrect handling may cause hazardous conditions, resulting in medium or slight personal injury or physical damage.

Depending on the circumstances, procedures indicated by **⚠ CAUTION** may also cause severe injury. It is important to follow all precautions for personal safety.

**Associated Manuals**

Manual name	Manual No.	Description
FX3U / FX3UC Series User's Manual - Analog Control Edition	JY997D16701 MODEL CODE: 09R619	Describes specifications for analog control and programming method for FX3U / FX3UC Series PLC.
FX3U/FX3UC Series Programming Manual - Basic & Applied Instruction Edition	JY997D16601 MODEL CODE: 09R517	Describes PLC programming for basic/applied instructions and devices.
FX3U Series User's Manual - Hardware Edition	JY997D16501 MODEL CODE: 09R516	Explains FX3U Series PLC specifications for I/O, wiring, installation, and maintenance.
FX3UC Series User's Manual - Hardware Edition	JY997D28701 MODEL CODE: 09R519	Explains FX3UC Series PLC specifications for I/O, wiring, installation, and maintenance.

**How to obtain manuals**

For product manuals or documents, consult with the Mitsubishi Electric dealer from who you purchased your product.

**Applicable standards**

FX3U-4AD-PTW-ADP units comply with the EC Directive (EMC Directive) and UL standards (UL, cUL). Further information can be found in the following manual. However, the FX3UC-32MT-LT does not comply with the EC Directive (EMC Directive) or UL standards (UL, cUL).

- Refer to the **FX3U Series Hardware Manual (Manual No. JY997D18801)**
- Refer to the **FX3UC (D, DSS) Series Hardware Manual (Manual No. JY997D28601)**

**Caution for EC Directive**

The analog special adapters have been found to be compliant to the European standards in the aforesaid manual and directive. However, for the very best performance from what are in fact delicate measuring and controlled output device Mitsubishi Electric would like to make the following points: As analog devices are sensitive by nature, their use should be considered carefully. For users of proprietary cables (integral with sensors or actuators), these users should follow those manufacturers installation requirements. Mitsubishi Electric recommend that shielded cables should be used. If NO other EMC protection is provided, then users may experience temporary loss or accuracy between ±10% in very heavy industrial areas. However, Mitsubishi Electric suggest that if adequate EMC precautions are followed for the users complete control system, users should expect accuracy as specified in this manual.

- Sensitive analog cable should not be laid in the same trunking or cable conduit as high voltage cabling. Where possible users should run analog cables separately.
- Good cable shielding should be used. When terminating the shield at Earth - ensure that no earth loops are accidentally created.
- When reading analog values, EMC accuracy can be improved out by averaging the readings. This can be achieved either through functions on the analog special adapters or through a users program in the FX3U(C) Series PLC main unit.

**1. Outline**

FX3U-4AD-PTW-ADP (hereinafter called PTW-ADP) is an analog special adapter for measuring temperature via four channels (three-wire sensors) of a connected Pt100 platinum resistance thermometer.

**1.1 Incorporated Items**

Verify that the following product and items are included in the package:

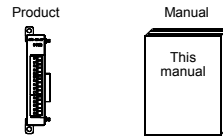

**1.2 External Dimensions, Part Names, and Terminal Layout**

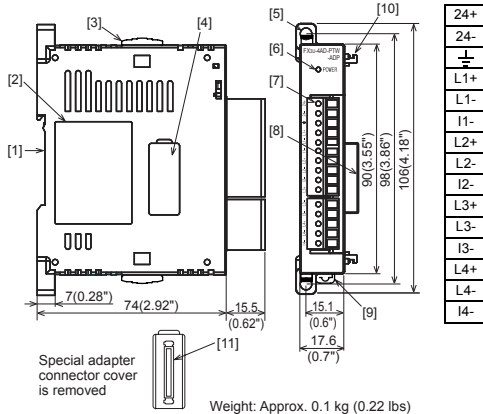

- [1] DIN rail mounting groove (DIN rail: DIN46277)
- [2] Name plate
- [3] Special adapter slide lock: Used to connect additional special adapters onto the left side of this special adapter.

- [4] Special adapter connector cover: Remove this cover to connect additional special adapters to the left side.
- [5] Direct mounting hole: 2 holes of  $\phi 4.5$  (0.18") (mounting screw: M4 screw) Not used when connecting to FX3UC Series PLC.
- [6] POWER LED (green): Lit while 24V DC power is supplied properly to terminals '24+' and '24-'.
- [7] Terminal block (European type): Connect platinum resistance thermometer (Pt100 three-wire type) and 24V DC power supply
- [8] Special adapter connector: Used to connect this special adapter to PLC main unit or special adapter.
- [9] DIN rail mounting hook
- [10] Special adapter fixing hook
- [11] Special adapter connector: Used to connect communication or analog special adapters to the left side of the PTW-ADP.

**2. Installation**

For installation/uninstallation details, refer to the following manuals:  
 → Refer to the **FX3U Series User's Manual - Hardware Edition**.  
 → Refer to the **FX3UC Series User's Manual - Hardware Edition**.

**INSTALLATION PRECAUTIONS** **⚠ DANGER**

- Make sure to cut off all phases of the power supply externally before attempting installation or wiring work. Failure to do so may cause electric shock or damage to the product.

**INSTALLATION PRECAUTIONS** **⚠ CAUTION**

- Use the product within the generic environment specifications described in PLC main unit manual (Hardware Edition). Never use the product in areas with excessive dust, oily smoke, conductive dusts, corrosive gas (salt air, Cl<sub>2</sub>, H<sub>2</sub>S, SO<sub>2</sub>, or NO<sub>2</sub>), flammable gas, vibration or impacts, or expose it to high temperature, condensation, or rain and wind. If the product is used in such conditions, electric shock, fire, malfunctions, deterioration or damage may occur.
- When drilling screw holes or wiring, make sure cutting or wire debris does not enter the ventilation slits. Failure to do so may cause fire, equipment failures or malfunctions.
- Do not touch the conductive parts of the product directly. Doing so may cause device failures or malfunctions.
- Connect special adapter securely to their designated connectors. Loose connections may cause malfunctions.

**2.1 Connection to the FX3U Series PLC**

**Procedure**

- 1) Turn off the power. Disconnect all the cables connected to the PLC main unit and special adapter, and demount the main unit and special adapter mounted on DIN rail or mounted directly using screws.
- 2) Install an expansion board to the main unit. For the expansion board installation procedure, refer to the following manual:  
 → Refer to the **FX3U Series User's Manual - Hardware Edition**
- 3) Remove the special adapter connector cover on the expansion board (fig.A). When connecting this product to another special adapter, please replace the 'main unit' in the above description with a 'special adapter' and perform the procedure as indicated.
- 4) Slide the special adapter slide lock (fig.B) of the main unit. When connecting this product to another special adapter, please replace the 'main unit' in the above description with a 'special adapter' and perform the procedure as indicated.

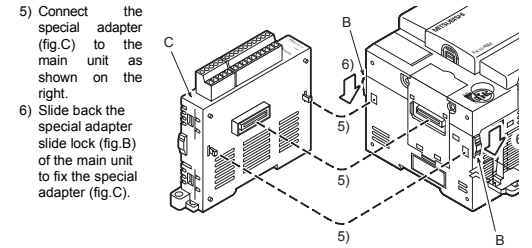
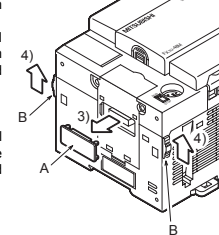

**Connection precautions**

Connect all the high-speed I/O special adapters before connecting other special adapters when they are used in combination. **Do not connect a high-speed I/O special adapter on the left side of a communication or analog special adapter.**

**2.2 Connection to the FX3UC (D, DSS) Series PLC**

**Procedure**

- 1) Turn off the power. Disconnect all the cables connected to the PLC, and demount the PLC from the DIN rail.
- 2) Remove the special adapter connector cover (fig.A)
- 3) Slide the special adapter slide lock (fig.B) of the main unit. When connecting this product to another special adapter, please replace the 'main unit' in the above description with a 'special adapter' and perform the procedure as indicated.

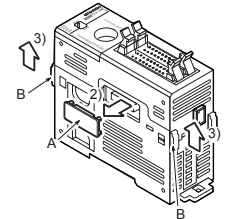

- 4) Connect the special adapter (fig.C) to the main unit as shown on the right
- 5) Slide back the special adapter slide lock (fig.B) of the main unit to fix the special adapter (fig.C).

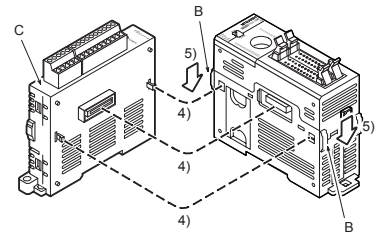

## 2.3 Connection to the FX3UC-32MT-LT PLC

### Procedure

- Turn off the power.  
Disconnect all the cables connected to the PLC, and demount the PLC from the DIN rail.
- Install an expansion board to the main unit.  
For the expansion board installation procedure, refer to the following manual:  
→ Refer to the FX3uc Series User's Manual - Hardware Edition

- Remove the special adapter connector cover on the expansion board (fig.A).  
When connecting this product to another special adapter, please replace the 'expansion board' in the above description with a 'special adapter' and perform the procedure as indicated.
- Slide the special adapter slide lock (fig.B) of the main unit.  
When connecting this product to another special adapter, please replace the 'main unit' in the above description with a 'special adapter' and perform the procedure as indicated.

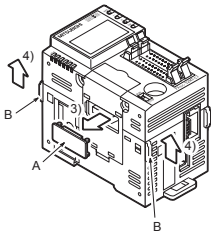

- Connect the special adapter (fig.C) to the main unit as shown on the right.
- Slide back the special adapter slide lock (fig.B) of the main unit to fix the special adapter (fig.C).

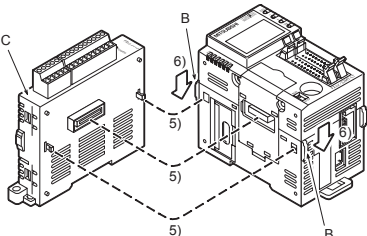

## 3. Wiring

**WIRING PRECAUTIONS** **⚠ DANGER**

- Make sure to cut off all phases of the power supply externally before attempting installation or wiring work.  
Failure to do so may cause electric shock or damage to the product.

**WIRING PRECAUTIONS** **⚠ CAUTION**

- Make sure to cut off all phases of the power supply externally before attempting installation or wiring work.  
Failure to do so may cause electric shock or damage to the product.
- Make sure to observe the following precautions in order to prevent any damage to the machinery or accidents due to abnormal data written to the PLC under the influence of noise:
  - Do not bundle the main circuit line together with or lay it close to the main circuit, high-voltage line or load line.  
Otherwise, noise disturbance and/or surge induction are likely to take place. As a guideline, lay the control line at least 100mm (3.94") or more away from the main circuit or high-voltage lines.
  - Ground the shield wire or shield of the shielded cable at one point on the PLC. However, do not use common grounding with heavy electrical systems.
- Make sure to properly wire to the European terminal board in accordance with the following precautions.  
Failure to do so may cause electric shock, a short-circuit, wire breakage, or damage to the product.
  - The disposal size of the cable end should be 9mm (0.35").
  - Tightening torque should be between 0.22 and 0.25N·m.
  - Twist the end of strand wire and make sure that there are no loose wires.
  - Do not solder-plate the electric wire ends.
  - Do not connect more than the specified number of wires or electric wires of unspecified size.
  - Affix the electric wires so that neither the terminal block nor the connected parts are directly stressed.
- Make sure to properly wire to the FX3U Series PLC in accordance with the following precautions.  
Failure to do so may cause electric shock, a short-circuit, wire breakage, or damage to the product.
  - The disposal size of the cable end should follow the dimensions described in this manual.
  - Tightening torque should follow the specifications in this manual.

## 3.1 Applicable cable and terminal tightening torque

### 3.1.1 Terminal block (European type)

- Wire size
  - The power supply wire should use 22-20 AWG wire.
  - Wiring to a Pt100 platinum resistance thermometer should be used the cable of it or a twisted shielded cable.

Type	Wire size
Single-wire	0.3mm <sup>2</sup> to 0.5mm <sup>2</sup> (AWG22 to 20)
2-wire	2 pieces of 0.3mm <sup>2</sup> (AWG22)

- Termination of cable end  
Strip the coating of strand wire and twist the cable core before connecting it, or strip the coating of single wire before connecting it.  
An alternative connection is to use a ferrule with insulating sleeve.

Manufacturer	Model	Pressure bonding tool
Phoenix Contact Co., Ltd.	AI 0.5-8WH	CRIMPFOX ZA 3 (or CRIMPFOX UD 6)

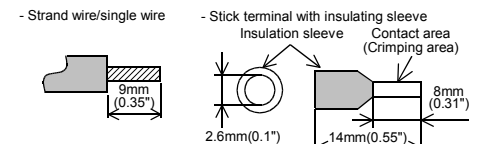

When using a stick terminal with insulating sleeve, choose a wire with proper cable sheath referring to the above outside dimensions, or otherwise, the wire cannot be inserted easily.  
The tightening torque must be 0.22 to 0.25N·m.

## 3.2 Power Supply Wiring

→ For the power supply wiring, refer to the FX3U / FX3uc Series User's Manual - Analog Control Edition

## 3.3 Selection of platinum resistance thermometer sensors

→ For the terminal configuration, refer to Section 1.2

### Precautions on platinum resistance thermometer wiring

- Type of platinum resistance thermometer  
Select Pt100 3-wire platinum resistance thermometer sensors.  
This thermometer will not be affected by voltage drop in the cable connection area, and will ensure accurate measurement.
- Separate the cable of the platinum resistance thermometer sensors from the other motive power cables or areas easily affected by inductive noise (of the commercial power, etc.).

### Example of platinum resistance thermometer wiring

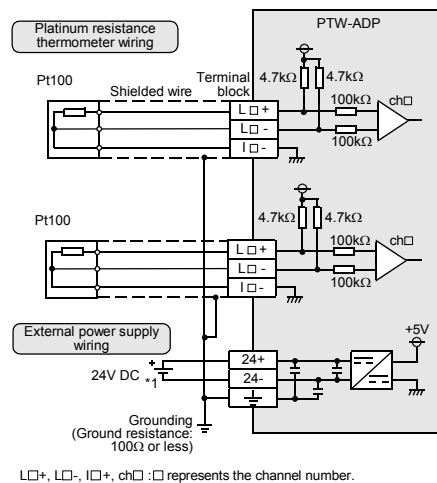

L□+, L□-, I□+, ch□ □ represents the channel number.

\*1 24V DC service power supply of the FX3U Series PLC can also be used.

## 3.4 Grounding

Grounding should be performed as stated below.

- The grounding resistance should be 100Ω or less.
- Independent grounding should be performed for best results.  
When independent grounding is not performed, perform "shared -" of the following figure.

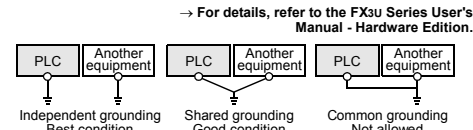

- The grounding wire size should be AWG 22-20 (0.3-0.5 mm<sup>2</sup>).
- The grounding point should be close to the PLC, and all grounding wire should be as short as possible.

## 4. Specifications

**STARTUP AND MAINTENANCE PRECAUTIONS** **⚠ CAUTION**

- Do not disassemble or modify the PLC.  
Doing so may cause fire, equipment failures, or malfunctions.  
\* For repair, contact your local Mitsubishi Electric distributor.
- Do not drop the product or exert strong impact to it.  
Doing so may cause damage.

**DISPOSAL PRECAUTIONS** **⚠ CAUTION**

- Please contact a certified electronic waste disposal company for the environmentally safe recycling and disposal of your device.

**TRANSPORT AND STORAGE PRECAUTIONS** **⚠ CAUTION**

- The product is a precision instrument. During transportation, avoid any impacts.  
Failure to do so may cause failures in the product. After transportation, verify the operations of the product.

### 4.1 Applicable PLC

Model name	Applicability
FX3U Series PLC	Ver. 2.20 or later (from first production)
FX3uc Series PLC	Ver. 1.30 or later (from the production manufactured in August, 2004 with SER No. 48****)

The version number can be checked by monitoring D8001 as the last three digits indicate it.

### 4.2 General Specifications

For the general specifications, refer to the manual of the PLC main unit.  
The items other than the following are equivalent to those of the PLC main unit.

Item	Specification
Dielectric withstand voltage	500V AC for one minute Conforming to JEM-1021 Between all terminals and ground terminal of PLC main unit
Insulation resistance	5MΩ or more by 500V DC megger

### 4.3 Power Supply Specifications

Item	Specification
A/D conversion circuit driving power	24V DC +20%/-15%, 50mA for 24V DC Connect a 24V DC power supply to the terminal block.
Interface driving power	5V DC, 15mA 5V DC power is supplied from the internal power supply of main unit.

## 4.4 Performance Specifications

Item	Description	
	Centigrade (°C)	Fahrenheit (°F)
Input signal	3-wire platinum resistance thermometer sensor Pt100 JIS C 1604-1997	
Rated temperature range	-100°C to +600°C	-148°F to +1112°F
Digital output	-1000 to +6000 -1480 to +11120	
Resolution	0.2 to 0.3°C	0.4 to 0.5°F
Total accuracy	±0.5% for full scale (when ambient temperature is 25°C±5°C) ±1.0% for full scale (when ambient temperature is in the range of 0 to 55°C)	
A/D conversion time	200μs (The data will be updated at every scan time of the PLC.)	
Input characteristics		
Insulation method	<ul style="list-style-type: none"> <li>The photo-coupler is adopted to insulate the analog input area from the PLC.</li> <li>The DC/DC converter is adopted to insulate the driving power supply line from the analog input area.</li> <li>Channels are not insulated from each other.</li> </ul>	
Occupied points	0 point (This number is not related to the maximum number of input/output points of the PLC.)	

This manual confers no industrial property rights or any rights of any other kind, nor does it confer any patent licenses. Mitsubishi Electric Corporation cannot be held responsible for any problems involving industrial property rights which may occur as a result of using the contents noted in this manual.

### Warranty

Mitsubishi will not be held liable for damage caused by factors found not to be the cause of Mitsubishi; opportunity loss or lost profits caused by faults in the Mitsubishi products; damage, secondary damage, accident compensation caused by special factors unpredictable by Mitsubishi; damages to products other than Mitsubishi products; and to other duties.

### ⚠ For safe use

- This product has been manufactured as a general-purpose part for general industries, and has not been designed or manufactured to be incorporated in a device or system used in purposes related to human life.
- Before using the product for special purposes such as nuclear power, electric power, aerospace, medicine or passenger movement vehicles, consult with Mitsubishi Electric.
- This product has been manufactured under strict quality control. However when installing the product where major accidents or losses could occur if the product fails, install appropriate backup or failsafe functions in the system.

**MITSUBISHI ELECTRIC CORPORATION**

HEAD OFFICE : TOKYO BUILDING, 2-7-3 MARUNOUCHI, CHIYODA-KU, TOKYO 100-8310, JAPAN  
HIMEJI WORKS : 840, CHIYODA CHO, HIMEJI, JAPAN



**MITSUBISHI** *Changes for the Better*  
**PROGRAMMABLE CONTROLLERS**  
**FX3U-4AD-PTW-ADP**  
**USER'S MANUAL**

Manual Number	JY997D29101
Revision	A
Date	December 2007

This manual describes the part names, dimensions, mounting, and specifications of the product. Before use, read this manual and the manuals of all relevant products fully to acquire proficiency in handling and operating the product. Make sure to learn all the product information, safety information, and precautions.

Store this manual in a safe place so that it can be taken out and read whenever necessary. Always forward it to the end user.

Registration: The company and product names described in this manual are registered trademarks or the trademarks of their respective companies.

Effective December 2007  
 Specifications are subject to change without notice.  
 © 2007 Mitsubishi Electric Corporation

**Safety Precaution** (Read these precautions before use.)  
 This manual classifies the safety precautions into two categories:  
 ⚠ **DANGER** and ⚠ **CAUTION**.

<b>DANGER</b>	Indicates that incorrect handling may cause hazardous conditions, resulting in death or severe injury.
<b>CAUTION</b>	Indicates that incorrect handling may cause hazardous conditions, resulting in medium or slight personal injury or physical damage.

Depending on the circumstances, procedures indicated by **CAUTION** may also cause severe injury. It is important to follow all precautions for personal safety.

**Associated Manuals**

Manual name	Manual No.	Description
FX3U / FX3UC Series User's Manual - Analog Control Edition	JY997D16701 MODEL CODE: 09R619	Describes specifications for analog control and programming method for FX3U / FX3UC Series PLC.
FX3U/FX3UC Series Programming Manual - Basic & Applied Instruction Edition	JY997D16601 MODEL CODE: 09R517	Describes PLC programming for basic/applied instructions and devices.
FX3U Series User's Manual - Hardware Edition	JY997D16501 MODEL CODE: 09R516	Explains FX3U Series PLC specifications for I/O, wiring, installation, and maintenance.
FX3UC Series User's Manual - Hardware Edition	JY997D28701 MODEL CODE: 09R519	Explains FX3UC Series PLC specifications for I/O, wiring, installation, and maintenance.

**How to obtain manuals**  
 For product manuals or documents, consult with the Mitsubishi Electric dealer from who you purchased your product.

**Applicable standards**  
 FX3U-4AD-PTW-ADP units comply with the EC Directive (EMC Directive) and UL standards (UL, cUL). Further information can be found in the following manual. However, the FX3UC-32MT-LT does not comply with the EC Directive (EMC Directive) or UL standards (UL, cUL).  
 → Refer to the **FX3U Series Hardware Manual (Manual No. JY997D18801)**  
 → Refer to the **FX3UC (D, DSS) Series Hardware Manual (Manual No. JY997D28601)**

**Caution for EC Directive**  
 The analog special adapters have been found to be compliant to the European standards in the aforesaid manual and directive. However, for the very best performance from what are in fact delicate measuring and controlled output device Mitsubishi Electric would like to make the following points:  
 As analog devices are sensitive by nature, their use should be considered carefully. For users of proprietary cables (integral with sensors or actuators), these users should follow those manufacturers installation requirements. Mitsubishi Electric recommend that shielded cables should be used. If NO other EMC protection is provided, then users may experience temporary loss or accuracy between ±10% in very heavy industrial areas. However, Mitsubishi Electric suggest that if adequate EMC precautions are followed for the users complete control system, users should expect accuracy as specified in this manual.

- Suitable analog cable should not be laid in the same trunking or cable conduit as high voltage cabling. Where possible users should run analog cables separately.
- Good cable shielding should be used. When terminating the shield at Earth - ensure that no earth loops are accidentally created.
- When reading analog values, EMC accuracy can be improved out by averaging the readings. This can be achieved either through functions on the analog special adapters or through a users program in the FX3U(C) Series PLC main unit.

**1. Outline**  
 FX3U-4AD-PTW-ADP (hereinafter called PTW-ADP) is an analog special adapter for measuring temperature via four channels (three-wire sensors) of a connected Pt100 platinum resistance thermometer.

**1.1 Incorporated items**  
 Verify that the following product and items are included in the package:

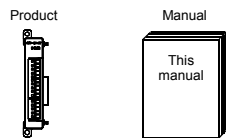

**1.2 External Dimensions, Part Names, and Terminal Layout**

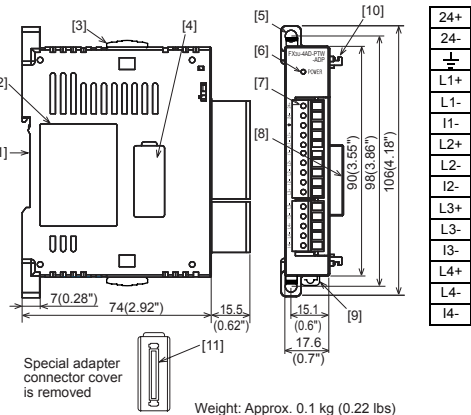

- [1] DIN rail mounting groove (DIN rail: DIN46277)
- [2] Name plate
- [3] Special adapter slide lock: Used to connect additional special adapters onto the left side of this special adapter.

- Special adapter connector cover: Remove this cover to connect additional special adapters to the left side.
- Direct mounting hole: 2 holes of φ4.5 (0.18") (mounting screw: M4 screw) Not used when connecting to FX3UC Series PLC.
- POWER LED (green): Lit while 24V DC power is supplied properly to terminals '24+' and '24-'.
- Terminal block (European type): Connect platinum resistance thermometer (Pt100 three-wire type) and 24V DC power supply.
- Special adapter connector: Used to connect this special adapter to PLC main unit or special adapter.
- DIN rail mounting hook
- Special adapter fixing hook
- Special adapter connector: Used to connect communication or analog special adapters to the left side of the PTW-ADP.

**2. Installation**  
 For installation/uninstallation details, refer to the following manuals:  
 → Refer to the **FX3U Series User's Manual - Hardware Edition**.  
 → Refer to the **FX3UC Series User's Manual - Hardware Edition**.

**INSTALLATION PRECAUTIONS** ⚠ **DANGER**

- Make sure to cut off all phases of the power supply externally before attempting installation or wiring work. Failure to do so may cause electric shock or damage to the product.

**INSTALLATION PRECAUTIONS** ⚠ **CAUTION**

- Use the product within the generic environment specifications described in PLC main unit manual (Hardware Edition). Never use the product in areas with excessive dust, oily smoke, conductive dusts, corrosive gas (salt air, Cl<sub>2</sub>, H<sub>2</sub>S, SO<sub>2</sub>, or NO<sub>2</sub>), flammable gas, vibration or impacts, or expose it to high temperature, condensation, or rain and wind. If the product is used in such conditions, electric shock, fire, malfunctions, deterioration or damage may occur.
- When drilling screw holes or wiring, make sure cutting or wire debris does not enter the ventilation slits. Failure to do so may cause fire, equipment failures or malfunctions.
- Do not touch the conductive parts of the product directly. Doing so may cause device failures or malfunctions.
- Connect special adapter securely to their designated connectors. Loose connections may cause malfunctions.

**2.1 Connection to the FX3U Series PLC**

- Procedure**
- Turn off the power. Disconnect all the cables connected to the PLC main unit and special adapter, and demount the main unit and special adapter mounted on DIN rail or mounted directly using screws.
  - Install an expansion board to the main unit. For the expansion board installation procedure, refer to the following manual:  
 → Refer to the **FX3U Series User's Manual - Hardware Edition**
  - Remove the special adapter connector cover on the expansion board (fig.A). When connecting this product to another special adapter, please replace the 'expansion board' in the above description with a 'special adapter' and perform the procedure as indicated.
  - Slide the special adapter slide lock (fig.B) of the main unit. When connecting this product to another special adapter, please replace the 'main unit' in the above description with a 'special adapter' and perform the procedure as indicated.

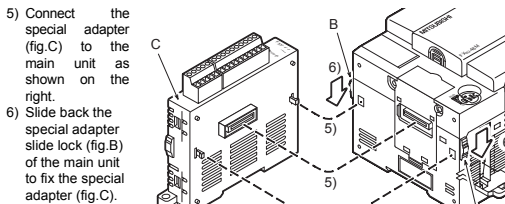
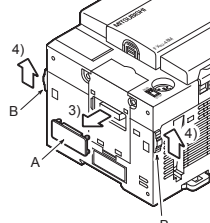

**Connection precautions**  
 Connect all the high-speed I/O special adapters before connecting other special adapters when they are used in combination.  
 Do not connect a high-speed I/O special adapter on the left side of a communication or analog special adapter.

**2.2 Connection to the FX3UC (D, DSS) Series PLC**

- Procedure**
- Turn off the power. Disconnect all the cables connected to the PLC, and demount the PLC from the DIN rail.
  - Remove the special adapter connector cover (fig.A)
  - Slide the special adapter slide lock (fig.B) of the main unit. When connecting this product to another special adapter, please replace the 'main unit' in the above description with a 'special adapter' and perform the procedure as indicated.

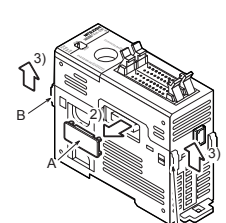

- Connect the special adapter (fig.C) to the main unit as shown on the right
- Slide back the special adapter slide lock (fig.B) of the main unit to fix the special adapter (fig.C).

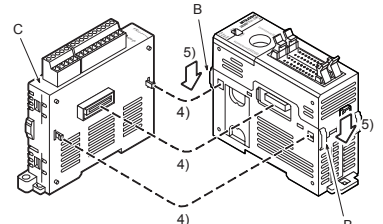

**2.3 Connection to the FX3UC-32MT-LT PLC**

- Procedure**
- Turn off the power. Disconnect all the cables connected to the PLC, and demount the PLC from the DIN rail.
  - Install an expansion board to the main unit. For the expansion board installation procedure, refer to the following manual:  
 → Refer to the **FX3UC Series User's Manual - Hardware Edition**
  - Remove the special adapter connector cover on the expansion board (fig.A). When connecting this product to another special adapter, please replace the 'expansion board' in the above description with a 'special adapter' and perform the procedure as indicated.
  - Slide the special adapter slide lock (fig.B) of the main unit. When connecting this product to another special adapter, please replace the 'main unit' in the above description with a 'special adapter' and perform the procedure as indicated.

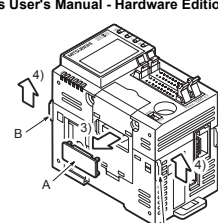

- Connect the special adapter (fig.C) to the main unit as shown on the right.
- Slide back the special adapter slide lock (fig.B) of the main unit to fix the special adapter (fig.C).

**3. Wiring**

**WIRING PRECAUTIONS** ⚠ **DANGER**

- Make sure to cut off all phases of the power supply externally before attempting installation or wiring work. Failure to do so may cause electric shock or damage to the product.

**WIRING PRECAUTIONS** ⚠ **CAUTION**

- Make sure to cut off all phases of the power supply externally before attempting installation or wiring work. Failure to do so may cause electric shock or damage to the product.
- Make sure to observe the following precautions in order to prevent any damage to the machinery or accidents due to abnormal data written to the PLC under the influence of noise:
  - Do not bundle the main circuit line together with or lay it close to the main circuit, high-voltage line or load line. Otherwise, noise disturbance and/or surge induction are likely to take place. As a guideline, lay the control line at least 100mm (3.94") or more away from the main circuit or high-voltage lines.
  - Ground the shield wire or shield of the shielded cable at one point on the PLC. However, do not use common grounding with heavy electrical systems.
- Make sure to properly wire to the European terminal board in accordance with the following precautions. Failure to do so may cause electric shock, a short-circuit, wire breakage, or damage to the product.
  - The disposal size of the cable end should be 9mm (0.35").
  - Tightening torque should be between 0.22 and 0.25N-m.
  - Twist the end of strand wire and make sure that there are no loose wires.
  - Do not solder-plate the electric wire ends.
  - Do not connect more than the specified number of wires or electric wires of unspecified size.
  - Affix the electric wires so that neither the terminal block nor the connected parts are directly stressed.
- Make sure to properly wire to the FX3U Series PLC in accordance with the following precautions. Failure to do so may cause electric shock, a short-circuit, wire breakage, or damage to the product.
  - The disposal size of the cable end should follow the dimensions described in this manual.
  - Tightening torque should follow the specifications in this manual.

**3.1 Applicable cable and terminal tightening torque**

- 3.1.1 Terminal block (European type)**
- Wire size
    - The power supply wire should use 22-20 AWG wire.
    - Wiring to a Pt100 platinum resistance thermometer should be used the cable of it or a twisted shielded cable.

Type	Wire size
Single-wire	0.3mm <sup>2</sup> to 0.5mm <sup>2</sup> (AWG22 to 20)
2-wire	2 pieces of 0.3mm <sup>2</sup> (AWG22)

- Termination of cable end  
 Strip the coating of strand wire and twist the cable core before connecting it, or strip the coating of single wire before connecting it. An alternative connection is to use a ferrule with insulating sleeve.

Manufacturer	Model	Pressure bonding tool
Phoenix Contact Co., Ltd.	AI 0.5-8WH	CRIMPFOX ZA 3 (or CRIMPFOX UD 6)

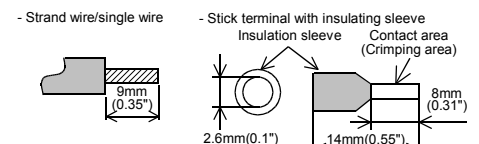

When using a stick terminal with insulating sleeve, choose a wire with proper cable sheath referring to the above outside dimensions, or otherwise, the wire cannot be inserted easily. The tightening torque must be 0.22 to 0.25N-m.

**3.2 Power Supply Wiring**

→ For the power supply wiring, refer to the **FX3U / FX3UC Series User's Manual - Analog Control Edition**

**3.3 Selection of platinum resistance thermometer sensors**

→ For the terminal configuration, refer to Section 1.2

- Precautions on platinum resistance thermometer wiring**
- Type of platinum resistance thermometer  
 Select Pt100 3-wire platinum resistance thermometer sensors. This thermometer will not be affected by voltage drop in the cable connection area, and will ensure accurate measurement.
  - Separate the cable of the platinum resistance thermometer sensors from the other motive power cables or areas easily affected by inductive noise (of the commercial power, etc.).

**Example of platinum resistance thermometer wiring**

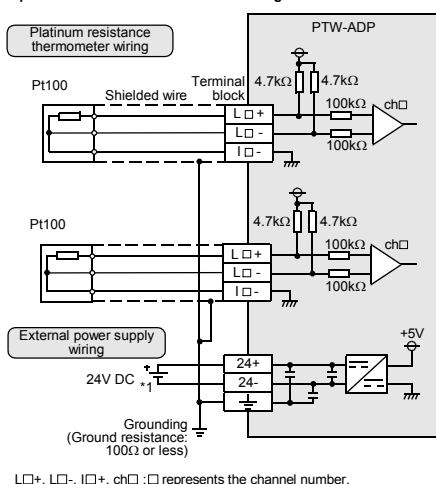

\*1 24V DC service power supply of the FX3U Series PLC can also be used.

**3.4 Grounding**

- Grounding should be performed as stated below.
- The grounding resistance should be 100Ω or less.
  - Independent grounding should be performed for best results. When independent grounding is not performed, perform "shared -" of the following figure.

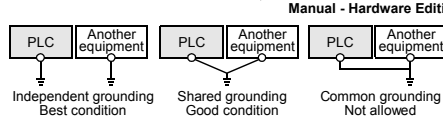

- The grounding wire size should be AWG 22-20 (0.3-0.5 mm<sup>2</sup>).
- The grounding point should be close to the PLC, and all grounding wire should be as short as possible.

**4. Specifications**

**STARTUP AND MAINTENANCE PRECAUTIONS** ⚠ **CAUTION**

- Do not disassemble or modify the PLC. Doing so may cause fire, equipment failures, or malfunctions. \* For repair, contact your local Mitsubishi Electric distributor.
- Do not drop the product or exert strong impact to it. Doing so may cause damage.

**DISPOSAL PRECAUTIONS** ⚠ **CAUTION**

- Please contact a certified electronic waste disposal company for the environmentally safe recycling and disposal of your device.

**TRANSPORT AND STORAGE PRECAUTIONS** ⚠ **CAUTION**

- The product is a precision instrument. During transportation, avoid any impacts. Failure to do so may cause failures in the product. After transportation, verify the operations of the product.

**4.1 Applicable PLC**

Model name	Applicability
FX3U Series PLC	Ver. 2.20 or later (from first production)
FX3UC Series PLC	Ver. 1.30 or later (from the production manufactured in August, 2004 with SER No. 48****)

The version number can be checked by monitoring D8001 as the last three digits indicate it.

**4.2 General Specifications**

For the general specifications, refer to the manual of the PLC main unit. The items other than the following are equivalent to those of the PLC main unit.

Item	Specification
Dielectric withstand voltage	500V AC for one minute Between all terminals and ground terminal of PLC main unit
Insulation resistance	5MΩ or more by 500V DC megger

**4.3 Power Supply Specifications**

Item	Specification
A/D conversion circuit driving power	24V DC +20%/ -15%, 50mA for 24V DC Connect a 24V DC power supply to the terminal block.
Interface driving power	5V DC, 15mA 5V DC power is supplied from the internal power supply of main unit.

**4.4 Performance Specifications**

Item	Description	
	Centigrade (°C)	Fahrenheit (°F)
Input signal	3-wire platinum resistance thermometer sensor Pt100 JIS C 1604-1997	
Rated temperature range	-100°C to +600°C	-148°F to +1112°F
Digital output	-1000 to +6000	-1480 to +11120
Resolution	0.2 to 0.3°C	0.4 to 0.5°F
Total accuracy	±0.5% for full scale (when ambient temperature is 25°C±5°C) ±1.0% for full scale (when ambient temperature is in the range of 0 to 55°C)	
A/D conversion time	200μs (The data will be updated at every scan time of the PLC.)	
Input characteristics		
Insulation method	<ul style="list-style-type: none"> <li>• The photo-coupler is adopted to insulate the analog input area from the PLC.</li> <li>• The DC/DC converter is adopted to insulate the driving power supply line from the analog input area.</li> <li>• Channels are not insulated from each other.</li> </ul>	
Occupied points	0 point (This number is not related to the maximum number of input/output points of the PLC.)	

This manual confers no industrial property rights or any rights of any other kind, nor does it confer any patent licenses. Mitsubishi Electric Corporation cannot be held responsible for any problems involving industrial property rights which may occur as a result of using the contents noted in this manual.

**Warranty**  
 Mitsubishi will not be held liable for damage caused by factors found not to be the cause of Mitsubishi; opportunity loss or lost profits caused by faults in the Mitsubishi products; damage, secondary damage, accident compensation caused by special factors unpredictable by Mitsubishi; damages to products other than Mitsubishi products; and to other duties.

**For safe use**

- This product has been manufactured as a general-purpose part for general industries, and has not been designed or manufactured to be incorporated in a device or system used in purposes related to human life.
- Before using the product for special purposes such as nuclear power, electric power, aerospace, medicine or passenger movement vehicles, consult with Mitsubishi Electric.
- This product has been manufactured under strict quality control. However when installing the product where major accidents or losses could occur if the product fails, install appropriate backup or failsafe functions in the system.