

MELFA Robots





Industrial Robot

Instruction Manual

RH-6SDH/12SDH/18SDH/20SDH **Robot Arm Setup & Maintenance**

Safety Precautions

Always read the following precautions and the separate "Safety Manual" before starting use of the robot to learn the required measures to be taken.

-  **CAUTION** All teaching work must be carried out by an operator who has received special training. (This also applies to maintenance work with the power source turned ON.)
Enforcement of safety training
-  **CAUTION** For teaching work, prepare a work plan related to the methods and procedures of operating the robot, and to the measures to be taken when an error occurs or when restarting. Carry out work following this plan. (This also applies to maintenance work with the power source turned ON.)
Preparation of work plan
-  **WARNING** Prepare a device that allows operation to be stopped immediately during teaching work. (This also applies to maintenance work with the power source turned ON.)
Setting of emergency stop switch
-  **CAUTION** During teaching work, place a sign indicating that teaching work is in progress on the start switch, etc. (This also applies to maintenance work with the power source turned ON.)
Indication of teaching work in progress
-  **WARNING** Provide a fence or enclosure during operation to prevent contact of the operator and robot.
Installation of safety fence
-  **CAUTION** Establish a set signaling method to the related operators for starting work, and follow this method.
Signaling of operation start
-  **CAUTION** As a principle turn the power OFF during maintenance work. Place a sign indicating that maintenance work is in progress on the start switch, etc.
Indication of maintenance work in progress
-  **CAUTION** Before starting work, inspect the robot, emergency stop switch and other related devices, etc., and confirm that there are no errors.
Inspection before starting work

The points of the precautions given in the separate "Safety Manual" are given below. Refer to the actual "Safety Manual" for details.

-  **CAUTION** Use the robot within the environment given in the specifications. Failure to do so could lead to a drop or reliability or faults. (Temperature, humidity, atmosphere, noise environment, etc.)
-  **CAUTION** Transport the robot with the designated transportation posture. Transporting the robot in a non-designated posture could lead to personal injuries or faults from dropping.
-  **CAUTION** Always use the robot installed on a secure table. Use in an instable posture could lead to positional deviation and vibration.
-  **CAUTION** Wire the cable as far away from noise sources as possible. If placed near a noise source, positional deviation or malfunction could occur.
-  **CAUTION** Do not apply excessive force on the connector or excessively bend the cable. Failure to observe this could lead to contact defects or wire breakage.
-  **CAUTION** Make sure that the workpiece weight, including the hand, does not exceed the rated load or tolerable torque. Exceeding these values could lead to alarms or faults.
-  **WARNING** Securely install the hand and tool, and securely grasp the workpiece. Failure to observe this could lead to personal injuries or damage if the object comes off or flies off during operation.
-  **WARNING** Securely ground the robot and controller. Failure to observe this could lead to malfunctioning by noise or to electric shock accidents.
-  **CAUTION** Indicate the operation state during robot operation. Failure to indicate the state could lead to operators approaching the robot or to incorrect operation.
-  **WARNING** When carrying out teaching work in the robot's movement range, always secure the priority right for the robot control. Failure to observe this could lead to personal injuries or damage if the robot is started with external commands.
-  **CAUTION** Keep the jog speed as low as possible, and always watch the robot. Failure to do so could lead to interference with the workpiece or peripheral devices.
-  **CAUTION** After editing the program, always confirm the operation with step operation before starting automatic operation. Failure to do so could lead to interference with peripheral devices because of programming mistakes, etc.
-  **CAUTION** Make sure that if the safety fence entrance door is opened during automatic operation, the door is locked or that the robot will automatically stop. Failure to do so could lead to personal injuries.
-  **CAUTION** Never carry out modifications based on personal judgments, or use non-designated maintenance parts. Failure to observe this could lead to faults or failures.
-  **WARNING** When the robot arm has to be moved by hand from an external area, do not place hands or fingers in the openings. Failure to observe this could lead to hands or fingers catching depending on the posture.

⚠ CAUTION Do not stop the robot or apply emergency stop by turning the robot controller's main power OFF. If the robot controller main power is turned OFF during automatic operation, the robot accuracy could be adversely affected. Moreover, it may interfere with the peripheral device by drop or move by inertia of the arm.

⚠ CAUTION Do not turn off the main power to the robot controller while rewriting the internal information of the robot controller such as the program or parameters. If the main power to the robot controller is turned off while in automatic operation or rewriting the program or parameters, the internal information of the robot controller may be damaged.

⚠ CAUTION Use the USB devices confirmed by manufacturer. In other case, it might have care difficulty by the effect of temperature, noise and so on. When using it, measures against the noise, such as measures against EMI and the addition of the ferrite core, may be necessary. Please fully confirm of the operation by the customer

C. Notes of the basic component are shown.

*SD series: CR1DA-700 series

⚠ CAUTION Please install the earth leakage breaker in the primary side supply power supply of the controller because of leakage protection.

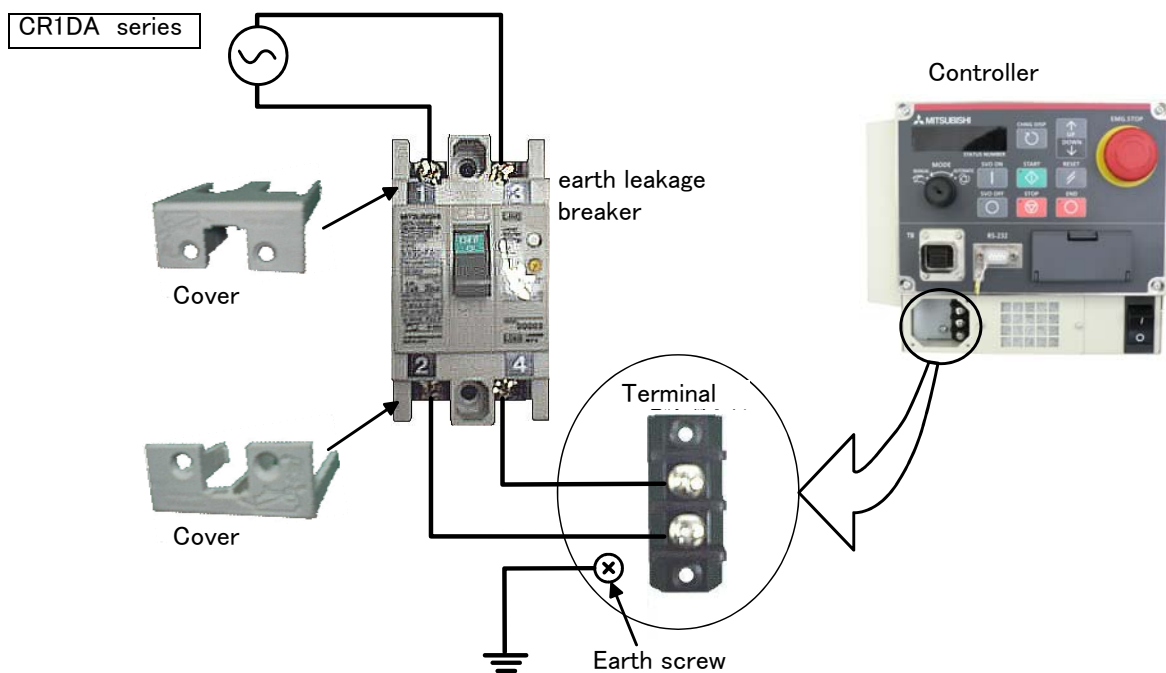

Revision history

Date of Point	Instruction Manual No.	Revision Details
2008-06-23	BFP-A8659	<ul style="list-style-type: none"> • First print
2008-11-20	BFP-A8659-A	<ul style="list-style-type: none"> • CE Marking specification was added. (Solenoid valve of source type I/O)
2009-04-24	BFP-A8659-B	<ul style="list-style-type: none"> • Added that the origin data to input is written in the robot examination report sheet. • When the minus driver was used, added that it is easier to remove the cover. • The solenoid valve installation procedure changed into piping the pneumatic hose after wiring. • Added that It is better to install option simultaneously. (Because the same cover) • The error in writing of hand output cable installation was corrected.
2009-06-08	BFP-A8659-C	<ul style="list-style-type: none"> • The caution at pulling out spare wiring was added. • Expression was corrected. (Origin data sheet), (Installing the option devices)
2009-09-25	BFP-A8659-D	<ul style="list-style-type: none"> • The error in writing of "(5) Inputting the origin data" in "2.4.2 Setting the origin with the origin data input method" was corrected.
2009-09-29	BFP-A8659-E	<ul style="list-style-type: none"> • The error in writing of "(4) Selecting the origin setting method" in "2.4.2 Setting the origin with the origin data input method" was corrected.
2009-10-29	BFP-A8659-F	<ul style="list-style-type: none"> • The EC Declaration of Conformity was changed. (Correspond to the EMC directive; 2006/42/EC)
2010-05-06	BFP-A8659-G	<ul style="list-style-type: none"> • The spare parts list was added. • The cautions which do not apply force to the shaft section (J3 axis) at transportation were added. • The type name of the controller was changed. (CR1 D to CR1DA, CR2D to CR2DA)
2010-07-06	BFP-A8659-H	<ul style="list-style-type: none"> • Description of RH-20SDH series was added.
2010-07-28	BFP-A8659-J	<ul style="list-style-type: none"> • Replacement procedure of packing was added and cover packing was added to the consumable part.
2010-08-12	BFP-A8659-K	<ul style="list-style-type: none"> • The consumable part (packing) list was added.

CONTENTS

	Page
1 Before starting use	1-1
1.1 Using the instruction manuals	1-1
1.1.1 The details of each instruction manuals	1-1
1.1.2 Symbols used in instruction manual	1-2
1.2 Safety Precautions	1-3
1.2.1 Precautions given in the separate Safety Manual	1-4
2 Unpacking to Installation	2-6
2.1 Confirming the product	2-6
2.2 Installation	2-7
2.2.1 Unpacking	2-7
2.2.2 Transportation procedures(Transportation by people: RH-6SDH series)	2-8
2.2.3 Transportation procedures(Transporting with a crane: RH-12SDH/18SDH/20SDH series)	2-9
2.2.4 Installation procedures	2-10
2.2.5 Grounding procedures	2-12
(1) Grounding methods	2-12
(2) Grounding procedures	2-12
2.2.6 Connecting with the controller	2-13
2.2.7 Procedure for wiring the hand output cables	2-15
2.2.8 No.2 arm area	2-16
2.2.9 Base area	2-18
2.2.10 Connection of piping for air pressurization	2-20
2.2.11 Connection of piping for suction	2-20
2.3 Setting the origin	2-21
2.3.1 Installing the teaching pendant (T/B)	2-21
2.3.2 Setting the origin with the origin data input method	2-22
(1) Confirming the origin data	2-22
(2) Turning ON the control power	2-22
(3) Preparing the T/B	2-23
(4) Selecting the origin setting method	2-24
(5) Inputting the origin data	2-25
(6) Installing the J1 cover.	2-26
2.4 Confirming the operation	2-27
(1) JOINT jog operation	2-31
(2) XYZ jog operation	2-33
(3) TOOL jog operation	2-35
(4) 3-axis XYZ jog operation	2-37
(5) CYLINDER jog operation	2-39
(6) Work jog operation	2-41
3 Installing the option devices	3-47
3.1 Installing the solenoid valve set (1S-VD04M(E)-03, 1S-VD04M(E)-04)	3-47
3.2 Installing the hand input cable	3-50
3.3 Installing the hand output cable	3-51
3.4 Changing the operating range	3-52
3.4.1 J1 and J2 axis	3-52
(1) Operating range changeable angle	3-52
(2) Installing the mechanical stopper	3-53
(3) Setting the operation range parameter	3-53
(4) Setting the mechanical stopper origin parameter	3-53
(5) Confirming the operation range	3-53
4 Basic operations	4-55
5 Maintenance and Inspection	5-56
5.1 Maintenance and inspection interval	5-56

	Page
5.2 Inspection items	5-57
5.2.1 Daily inspection items	5-57
5.2.2 Periodic inspection	5-58
5.3 Maintenance and inspection procedures	5-59
5.3.1 Robot arm structure	5-59
5.3.2 Installing/removing the cover	5-60
5.3.3 Packing Replacement Procedure	5-62
(1) Packing Replacement Instructions	5-62
5.3.4 Inspection, maintenance and replacement of timing belt	5-66
(1) Timing belt replacement period	5-66
(2) Inspection, maintenance and replacement of J3-axis timing belt	5-67
(3) Inspection, maintenance and replacement of J4-axis timing belt	5-69
(4) Timing belt tension	5-71
5.3.5 Replacing Bellows	5-72
(1) How to Replace the Top Bellows	5-72
(2) How to Replace the Bottom Bellows	5-74
5.3.6 Lubrication	5-75
(1) Lubrication position and specifications	5-75
(2) Lubrication method to the J1, J2 axis	5-75
(3) Lubrication method to the shaft	5-76
5.3.7 Replacing the backup battery	5-77
(1) Replacing the robot arm battery	5-78
5.4 About Overhaul	5-79
5.5 Maintenance parts	5-80
5.6 Resetting the origin	5-83
5.6.1 Mechanical stopper method	5-84
(1) J1 axis origin setting(mechanical stopper)	5-84
(2) J2 axis origin setting(mechanical stopper)	5-86
(3) J3 and J4 axis origin setting(mechanical stopper)	5-88
(4) All axis origin setting	5-91
5.6.2 Jig method	5-92
(1) J1 axis origin setting	5-93
(2) J2 axis origin setting	5-95
(3) J3 and J4 axis origin setting	5-96
(4) All axis origin setting	5-97
5.6.3 ABS origin method	5-98
(1) Select the T/B	5-99
5.6.4 User origin method	5-100
5.6.5 Recording the origin data	5-102
(1) Confirming the origin data label	5-102
(2) Confirming the origin data	5-102
(3) Recording the origin data	5-102
(4) Installing the cover	5-102
6Appendix	Appendix-103
Appendix 1 : Configuration flag	Appendix-103

1 Before starting use

This chapter explains the details and usage methods of the instruction manuals, the basic terminology and the safety precautions.

1.1 Using the instruction manuals

1.1.1 The details of each instruction manuals

The contents and purposes of the documents enclosed with this product are shown below. Use these documents according to the application.



For special specifications, a separate instruction manual describing the special section may be enclosed.

Safety Manual	Explains the common precautions and safety measures to be taken for robot handling, system design and manufacture to ensure safety of the operators involved with the robot.
Standard Specifications or special Specifications	Explains the product's standard specifications, factory-set special specifications, option configuration and maintenance parts, etc. Precautions for safety and technology, when incorporating the robot, are also explained.
Robot Arm Setup & Maintenance	Explains the procedures required to operate the robot arm (unpacking, transportation, installation, confirmation of operation), and the maintenance and inspection procedures.
Controller Setup, Basic Operation and Maintenance	Explains the procedures required to operate the controller (unpacking, transportation, installation, confirmation of operation), basic operation from creating the program to automatic operation, and the maintenance and inspection procedures.
Detailed Explanation of Functions and Operations	Explains details on the functions and operations such as each function and operation, commands used in the program, connection with the external input/output device, and parameters, etc.
Troubleshooting	Explains the causes and remedies to be taken when an error occurs. Explanations are given for each error No.
Additional axis function	Explains the specifications, functions and operations of the additional axis control.
Tracking Function Manual	Explains the control function and specifications of conveyor tracking.

1.1.2 Symbols used in instruction manual

The symbols and expressions shown in [Table 1-1](#) are used throughout this instruction manual. Learn the meaning of these symbols before reading this instruction manual.

Table 1-1 : Symbols in instruction manual

Terminology	Item/Symbol	Meaning
Item	The "Robot controller" or the "Controller"	Indicates the controller which controls the robot arm. Indicates the box which arranged control parts, such as robot CPU, servo amplifier, and the safety circuit.
Symbol	 DANGER	Precaution indicating cases where there is a risk of operator fatality or serious injury if handling is mistaken. Always observe these precautions to safely use the robot.
	 WARNING	Precaution indicating cases where the operator could be subject to fatalities or serious injuries if handling is mistaken. Always observe these precautions to safely use the robot.
	 CAUTION	Precaution indicating cases where operator could be subject to injury or physical damage could occur if handling is mistaken. Always observe these precautions to safely use the robot.
	[JOG]	If a word is enclosed in brackets or a box in the text, this refers to a key on the teaching pendant.
	[RESET] + [EXE] (A) (B)	This indicates to press the (B) key while holding down the (A) key. In this example, the [RESET] key is pressed while holding down the [+EXE] key.
	T/B	This indicates the teaching pendant.
	O/P	This indicates the operating panel on the front of the controller.

1.2 Safety Precautions

Always read the following precautions and the separate "Safety Manual" before starting use of the robot to learn the required measures to be taken.

CAUTION

All teaching work must be carried out by an operator who has received special training. (This also applies to maintenance work with the power source turned ON.)
Enforcement of safety training

CAUTION

For teaching work, prepare a work plan related to the methods and procedures of operating the robot, and to the measures to be taken when an error occurs or when restarting. Carry out work following this plan. (This also applies to maintenance work with the power source turned ON.)
Preparation of work plan

WARNING

Prepare a device that allows operation to be stopped immediately during teaching work. (This also applies to maintenance work with the power source turned ON.)
Setting of emergency stop switch

CAUTION

During teaching work, place a sign indicating that teaching work is in progress on the start switch, etc. (This also applies to maintenance work with the power source turned ON.)
Indication of teaching work in progress

DANGER

Provide a fence or enclosure during operation to prevent contact of the operator and robot.
Installation of safety fence

CAUTION

Establish a set signaling method to the related operators for starting work, and follow this method.
Signaling of operation start

CAUTION

As a principle turn the power OFF during maintenance work. Place a sign indicating that maintenance work is in progress on the start switch, etc.
Indication of maintenance work in progress

CAUTION

Before starting work, inspect the robot, emergency stop switch and other related devices, etc., and confirm that there are no errors.
Inspection before starting work

1.2.1 Precautions given in the separate Safety Manual

The points of the precautions given in the separate "Safety Manual" are given below.
Refer to the actual "Safety Manual" for details.

 **DANGER**

If the automatic operation of the robot is operated by two or more control equipment, design the right management of operation of each equipment of the customer.

 **CAUTION**

Use the robot within the environment given in the specifications. Failure to do so could lead to a drop or reliability or faults. (Temperature, humidity, atmosphere, noise environment, etc.)

 **CAUTION**

Transport the robot with the designated transportation posture. Transporting the robot in a non-designated posture could lead to personal injuries or faults from dropping.

 **CAUTION**

Always use the robot installed on a secure table. Use in an instable posture could lead to positional deviation and vibration.

 **CAUTION**

Wire the cable as far away from noise sources as possible. If placed near a noise source, positional deviation or malfunction could occur.

 **CAUTION**

Do not apply excessive force on the connector or excessively bend the cable. Failure to observe this could lead to contact defects or wire breakage.

 **CAUTION**

Make sure that the workpiece weight, including the hand, does not exceed the rated load or tolerable torque. Exceeding these values could lead to alarms or faults.

 **WARNING**

Securely install the hand and tool, and securely grasp the workpiece. Failure to observe this could lead to personal injuries or damage if the object comes off or flies off during operation.

 **WARNING**

Securely ground the robot and controller. Failure to observe this could lead to malfunctioning by noise or to electric shock accidents.

 **CAUTION**

Indicate the operation state during robot operation. Failure to indicate the state could lead to operators approaching the robot or to incorrect operation.

 **WARNING**

When carrying out teaching work in the robot's movement range, always secure the priority right for the robot control. Failure to observe this could lead to personal injuries or damage if the robot is started with external commands.

 **CAUTION**

Keep the jog speed as low as possible, and always watch the robot. Failure to do so could lead to interference with the workpiece or peripheral devices.

 **CAUTION**

After editing the program, always confirm the operation with step operation before starting automatic operation. Failure to do so could lead to interference with peripheral devices because of programming mistakes, etc.
Make sure that if the safety fence entrance door is opened during automatic operation, the door is locked or that the robot will automatically stop. Failure to do so could lead to personal injuries.

 **CAUTION**

Never carry out modifications based on personal judgments, or use non-designated maintenance parts.
Failure to observe this could lead to faults or failures.

 **WARNING**

When the robot arm has to be moved by hand from an external area, do not place hands or fingers in the openings. Failure to observe this could lead to hands or fingers catching depending on the posture.

 CAUTION

Do not stop the robot or apply emergency stop by turning the robot controller's main power OFF.
If the robot controller main power is turned OFF during automatic operation, the robot accuracy could be adversely affected.

 CAUTION

Do not turn off the main power to the robot controller while rewriting the internal information of the robot controller such as the program or parameters. If the main power to the robot controller is turned off while in automatic operation or rewriting the program or parameters, the internal information of the robot controller may be damaged.

 DANGER

When the SSCNETIII cable is removed, install the cap in the connector.
If the cap is not installed, there is a possibility of malfunctioning by adhesion of the dust etc.

 DANGER

Don't remove the SSCNETIII cable, when the power supply of the robot controller is turned on. Don't face squarely the light emitted from the tip of the SSCNETIII connector or the cable. If light strikes the eyes, there is a possibility of feeling the sense of incongruity for the eyes. (The light source of SSCNETIII is equivalent to the class 1 specified to JISC6802 and IEC60825-1.)

2 Unpacking to Installation

2.1 Confirming the product

The standard configuration of the robot arm, part of the purchased product, is shown in [Table 2-1](#).

Confirm the parts.

Users who have purchased optional products should refer to the separate “Standard Specifications”.

Table 2-1 : Standard configuration

No.	Part name	Type	Qty.	Remarks
RH-6SDH series				
1	Robot arm		1 unit	
2	Guarantee card		1 copy	
3	Installation bolts	M8 x 40	4 pcs.	For robot arm installation
4	Spring washer for installation bolts	For M8	4 pcs.	
5	Plain washer for installation bolts	For M8	4 pcs.	
6	Fixing plates		1 set	For robot arm transportation
7	Fixing plates installation bolt		1 set	
8	Grommet		1 pcs.	For hand output cable wiring port
RH-12SDH/18SDH/20SDH series				
1	Robot arm		1 unit	
2	Guarantee card		1 copy	
3	Installation bolts	M12 x 45	4 pcs.	For robot arm installation
4	Spring washer for installation bolts	For M12	4 pcs.	
5	Plain washer for installation bolts	For M12	4 pcs.	
6	Fixing plates		1 set	For robot arm transportation
7	Fixing plates installation bolt		1 set	
8	Suspension fitting		1 set	
9	Suspension fitting installation bolts		1 set	
10	Grommet		1 pcs.	

2.2 Installation

2.2.1 Unpacking

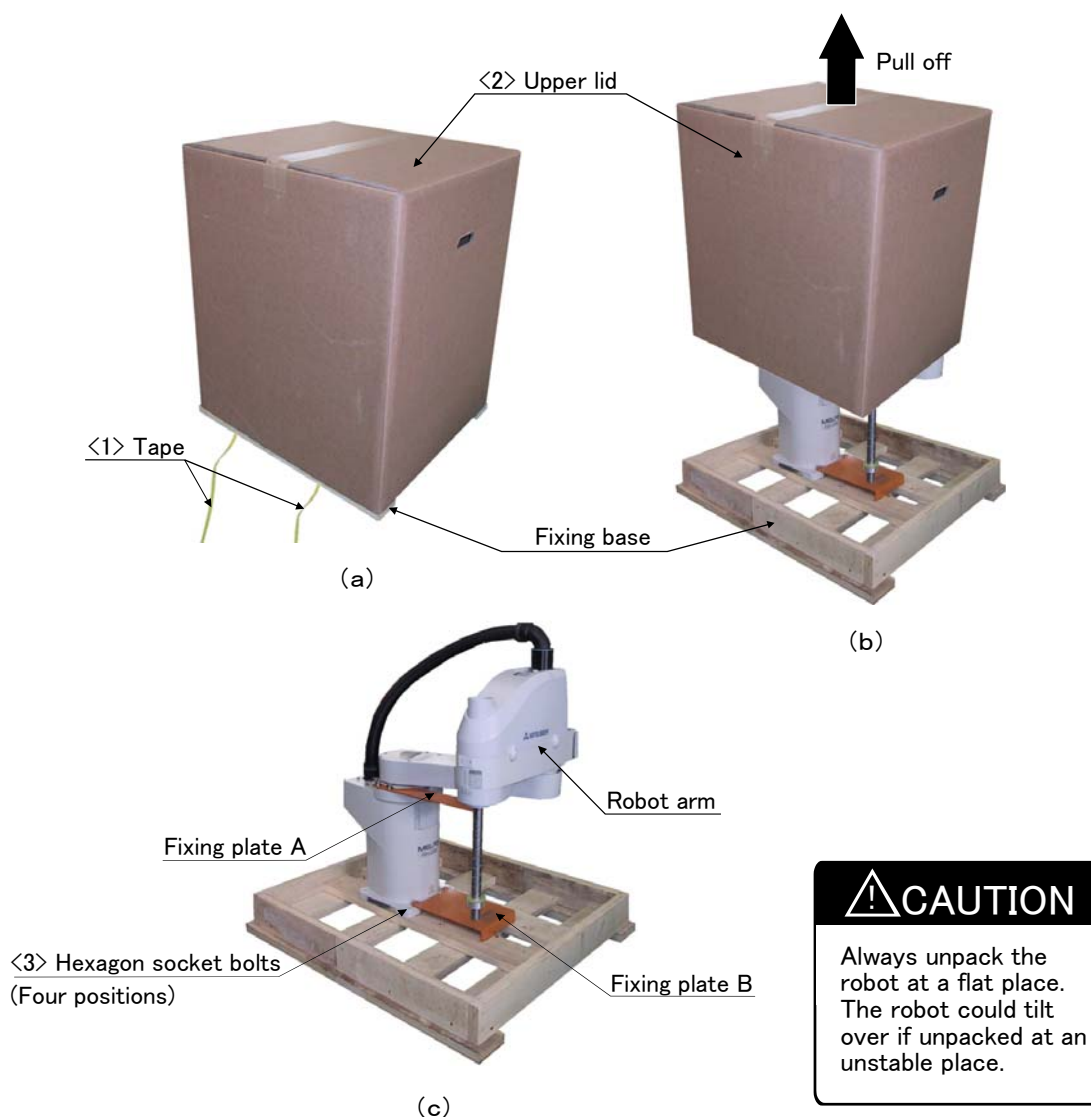

Fig.2-1 : Unpacking the robot arm

The robot is shipped from the factory in cardboard and plywood frame packing. Always refer to Fig. 2-1 and unpack the robot. Be sure to transport the RH-6SDH series according to "2.2.2 Transportation procedures(Transportation by people: RH-6SDH series)", and transport the RH-12SDH/18SDH/20SDH series according to "2.2.3 Transportation procedures(Transporting with a crane: RH-12SDH/18SDH/20SDH series)".

- 1) Using a knife, etc., slit the tape <1> fixing the upper lid <2> of the cardboard box. (Fig. 2-1 (a))
- 2) Pull the upper lid <2> of the cardboard box off with both hands. (Fig. 2-1 (b))
- 3) Remove the hexagon socket bolts <3> (four positions) connecting the sleeper and the base unit. (Fig. 2-1 (c))
- 4) This completes the unpacking.

CAUTION When repackaging the robot in the wooden frame, always use the fixing plate.

2.2.2 Transportation procedures(Transportation by people: RH-6SDH series)

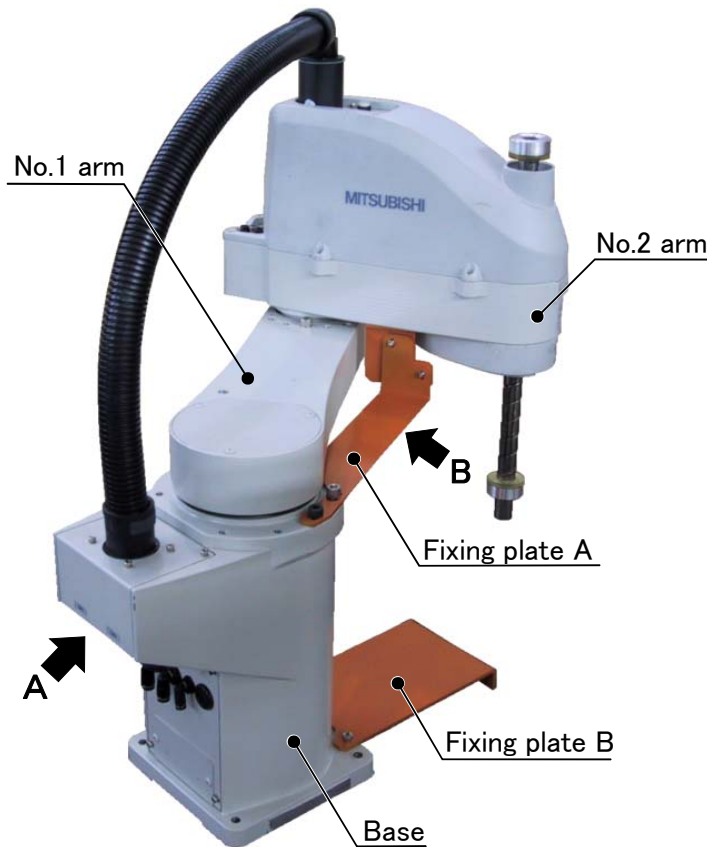

Mass
 RH-6SDH3520 series : Approx. 23kg
 RH-6SDH4520 series : Approx. 24kg
 RH-6SDH5520 series : Approx. 24kg
 RH-6SDH3517C series : Approx. 23kg
 RH-6SDH4517C series : Approx. 24kg
 RH-6SDH5517C series : Approx. 24kg
 RH-6SDH3517M series : Approx. 23kg
 RH-6SDH4517M series : Approx. 24kg
 RH-6SDH5517M series : Approx. 24kg

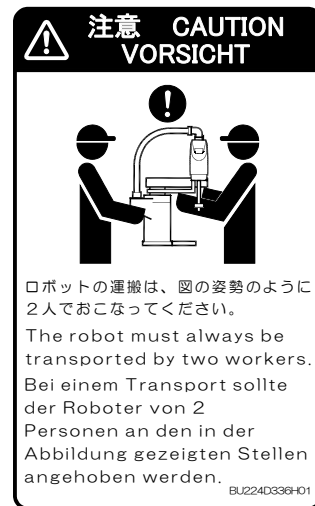

Fig.2-2 : Transportation of robot arm

- 1) The robot must be transported by two workers with putting the fixing plate A and B. Place the robot on a dolly, etc., and move it to near the installation place. Transporting the robot with the following grips should be limited to placing the robot on the frame or dolly, and to positioning.
- 2) When transporting the robot arm, one person should hold the rear part of the base area (A) and another person should hold the fixing plate A and No.1 arm (B).
 Never hold the robot from the left/right side or the cover. It may lead to accidents such as the cover dropping off and the robot falling over, causing damage.
- 3) When transporting the robot, do not apply force on the cover, or apply a strong impact on the robot.
- 4) Remove the fixtures after installing the robot.

CAUTION To prevent accidents, do not hold the robot from the left/right sides, or hold covers that have no grips .

CAUTION Be careful not to apply force to the shaft section (J3 axis). The shaft may be damaged and the overload error may occur at the time of movement.

CAUTION When installing the fixing tool again, place the robot in the posture where each axis shows the values listed in the table below.

Table 2-2 : Transportation posture(RH-6SDH series)

Axis	RH-6SDH35*	RH-6SDH45*	RH-6SDH55*
J 1	49.5 deg.	25 deg.	17 deg.
J 2	-139.5 deg.	-115 deg.	-107 deg.
J 3	97mm	97mm	97mm
J 4	Not fixed	Not fixed	Not fixed

2.2.3 Transportation procedures(Transporting with a crane: RH-12SDH/18SDH/20SDH series)

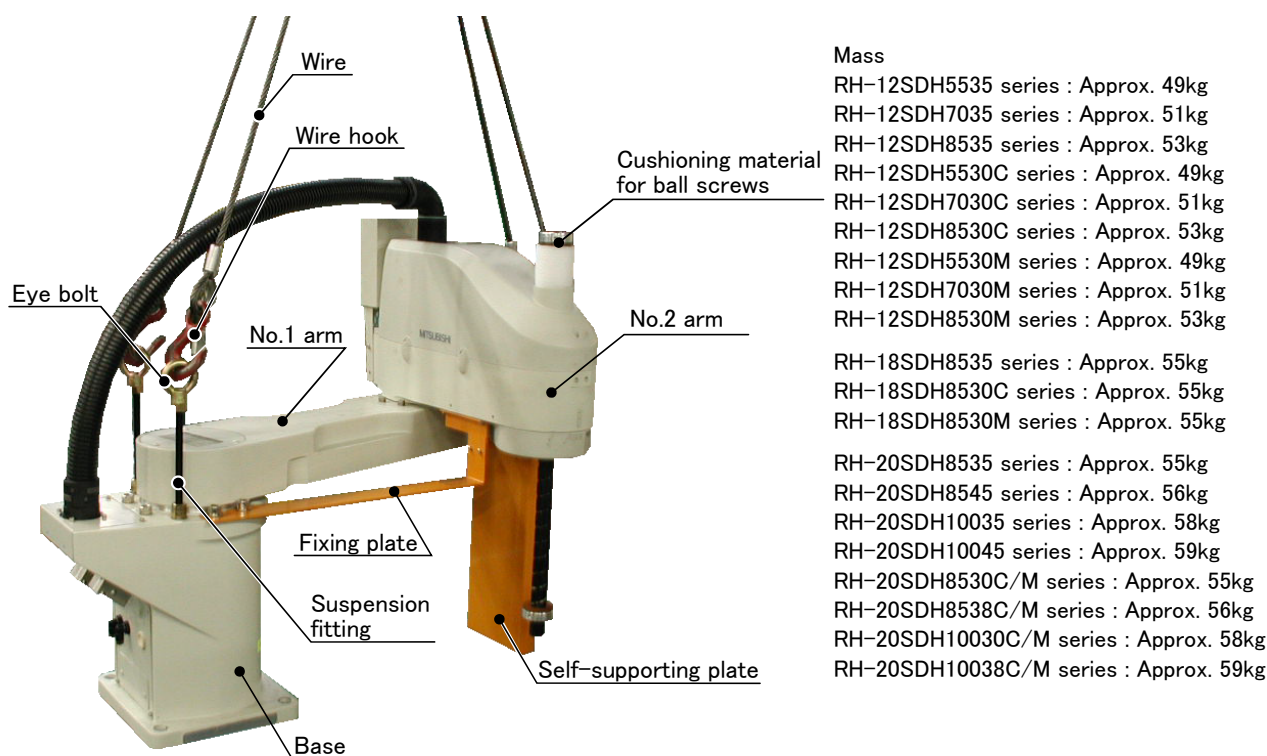

Fig.2-3 : Transportation of robot arm

- 1) Hook the wires to each of the four eyebolts attached to the suspension fitting. (Make sure the bolts are securely hooked.)
- 2) Lift with a crane to transport the robot to the designated location.
- 3) At this time, make sure that the wires, etc., do not interfere with the robot arm or covers. Always place cloth, etc., at interfering places.
- 4) Be careful not to subject the robot to physical shock during transport.
- 5) After installing the robot (refer to "2.2.4 Installation procedures" on page 10), remove the wires, the wire hooks (the robot will stand by itself as shown in Fig. 2-3), the self-supporting plate, suspension fitting and fixing plate.
- 6) Always follow the above procedures and methods to transport the robot for secondary transportation, such as when changing the installation position.
If the arm is directly suspended without using the specified suspension fittings, or if it is suspended in the work posture, the configuration devices could be damaged, and the transportation workers will be subject to risk due to an inadequate center of gravity position.

CAUTION When transporting a robot, always attach four wires.

CAUTION To reattach the fixing plate again, set the axes of the robot to the positions according to the table below.

Table 2-3 : Transportation posture(RH-12SDH/18SDH/20SDH series)

Axis	RH-12SDH55*	RH-12SDH70*	RH-12SDH85*/18SDH85*/20SDH*
J 1	37.5 deg.	21.4 deg.	15.1 deg.
J 2	-127.5 deg.	-111.4 deg.	-105.1 deg.
J 3 (Note1)	84.5mm	84.5mm	84.5mm
J 4	Not fixed	Not fixed	Not fixed

Note1) The bottom surface of the shaft will interfere with the floor if the J3 axis is lowered down to the upper mechanical stopper. Position the axes as indicated when transporting the robot.

2.2.4 Installation procedures

The installation procedure of the robot arm is shown below.

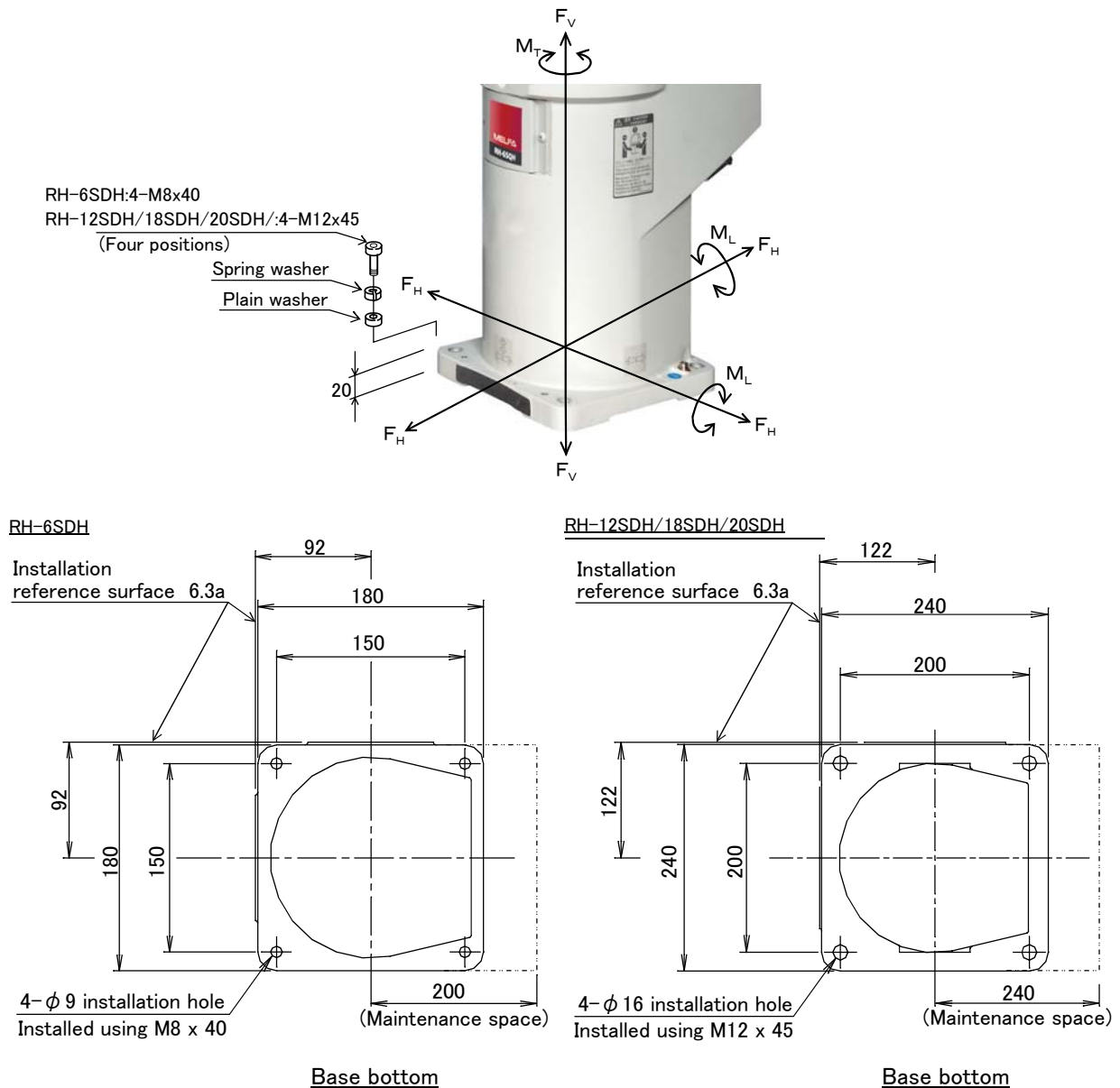

Fig.2-4 : Installation dimensions

- 1) The robot installation surface has been machine finished. Use the installation holes (RH-6SDH series: 4-φ 9 holes, RH-12SDH/18SDH/20SDH: 4-φ 16 holes) opened at the four corners of the base, and securely fix the robot with the enclosed installation bolts (hexagon socket bolts).
- 2) Install the robot on a level surface.
- 3) It is recommended that the surface roughness of the table onto which the robot is to be installed by 6.3a or more. If the installation surface is rough, the contact with the table will be poor, and positional deviation could occur when the robot moves.
- 4) When installing, use a common table to prevent the position of the devices and jigs subject to robot work from deviating.
- 5) The installation surface must have sufficient strength to withstand the arm reaction during operation, and resistance against deformation and vibration caused by the static (dynamic) load of the robot arm and peripheral devices, etc.
- 6) After installing the robot, remove the self-supporting plate, suspension fitting, and fixing plate.
- 7) If you operate the robot at a high speed, reaction forces are applied to the installation stand by the robot's operation. Make sure that the installation stand on which the robot is placed has sufficient strength and

rigidity. Table 2-4 shows the maximum reaction force (design values) that may be applied to an installation stand. Please use these values as reference when designing the installation stand.

Table 2-4 : Magnitude of each reaction force

	Unit	Value
RH-6SDH series		
Tilt moment : M_L	N · m	380
Torsional moment : M_T	N · m	410
Horizontal direction translation force : F_H	N	920
Vertical direction translation force : F_V	N	570
RH-12SDH/18SDH/20SDH series		
Tilt moment : M_L	N · m	1,310
Torsional moment : M_T	N · m	1,440
Horizontal direction translation force : F_H	N	1,900
Vertical direction translation force : F_V	N	1,280



CAUTION

When installing the robot, secure enough space behind the robot for future maintenance to allow the connection of cables and the replacement of the backup battery.

2.2.5 Grounding procedures

(1) Grounding methods

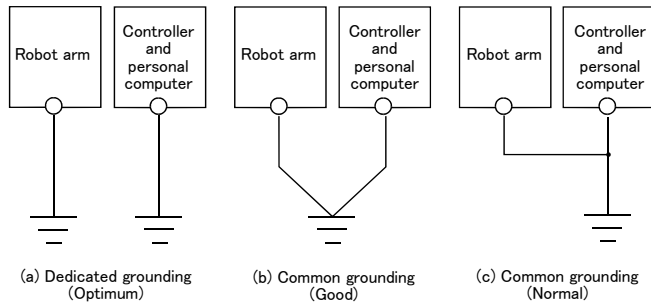

- 1) There are three grounding methods as shown in Fig. 2-5, but the dedicated grounding (Fig. 2-5 (a)) should be used for the robot arm and controller when possible. (Refer to the separate "Controller Setup, Basic Operation and Maintenance" for details on the controller grounding.)
- 2) Use Class D grounding (grounding resistance 100Ω or less). Dedicated grounding separated from the other devices should be used.
- 3) Use a AWG#11(3.5mm²) or more stranded wire for the grounding wire. The grounding point should be as close to the robot arm and controller as possible, and the length of the grounding wire should be short.

Fig.2-5 : Grounding methods

(2) Grounding procedures

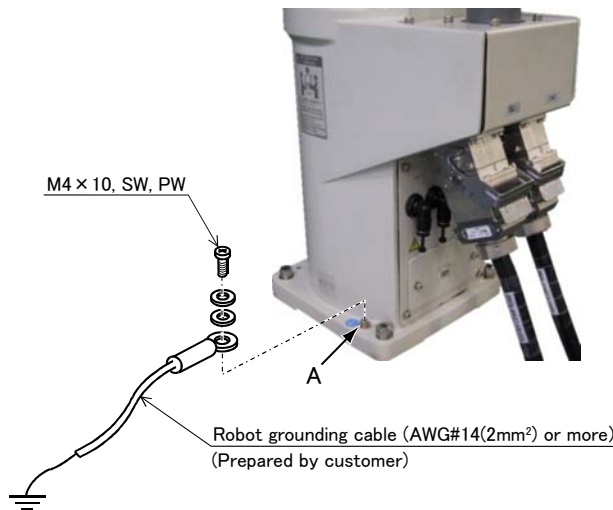

- 1) Prepare the grounding cable (AWG#14(2mm²) or more) and robot side installation screw and washer.
- 2) If there is rust or paint on the grounding screw section (A), remove it with a file, etc.
- 3) Connect the grounding cable to the grounding screw section.

Fig.2-6 : Connecting the grounding cable

2.2.6 Connecting with the controller

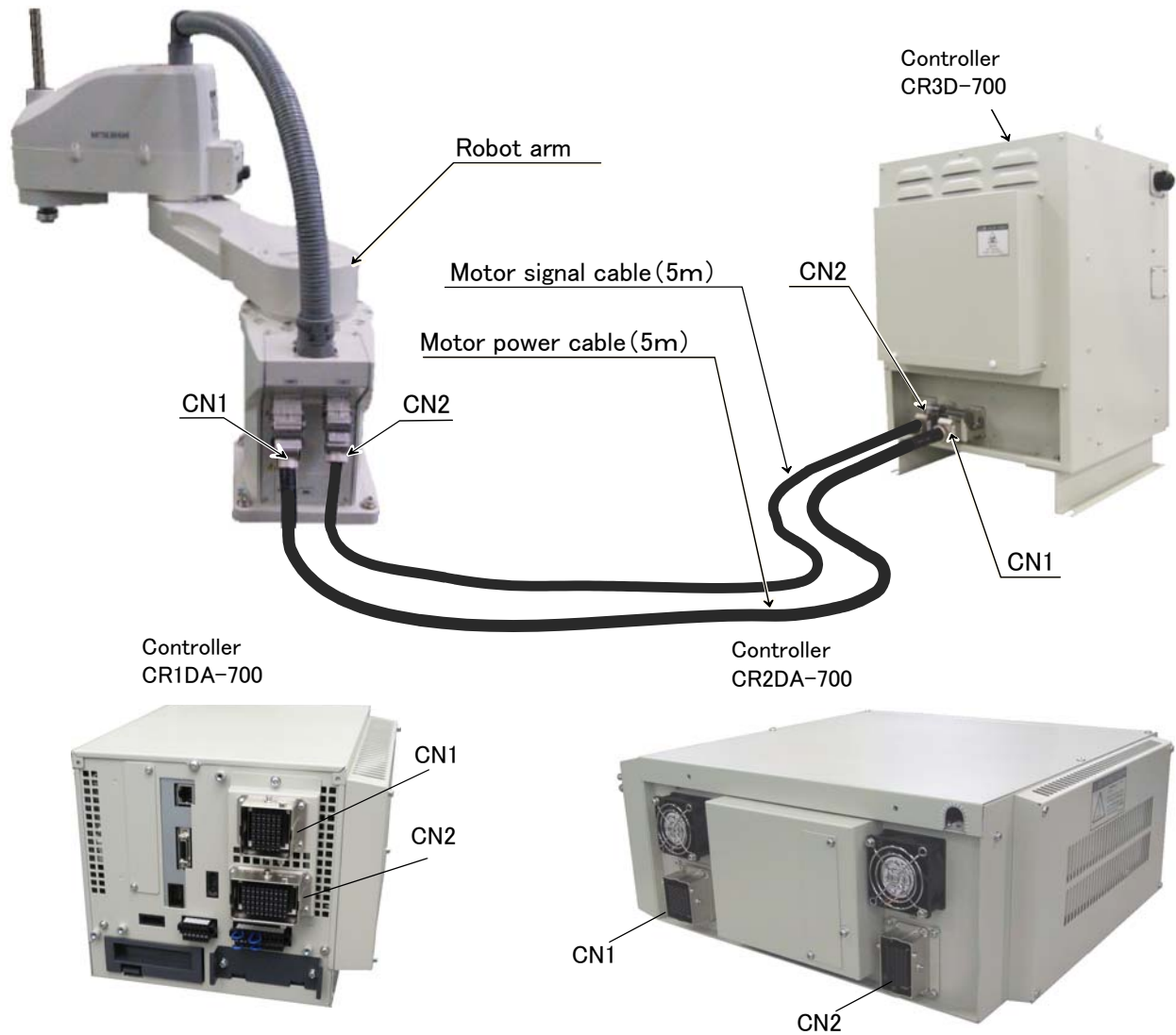
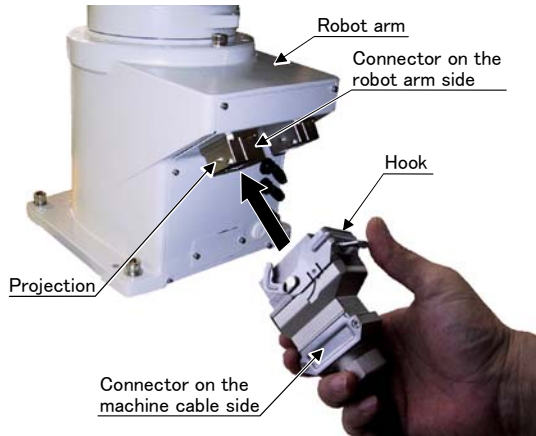
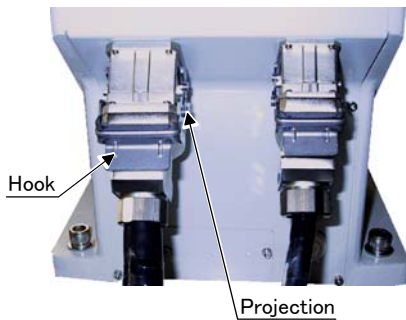

Fig.2-7 : Connecting the machine cables

Carry out the following procedure after installing the controller referring to the separate "Controller Setup, Basic Operation and Maintenance" manual.



- 1) Make sure that the power switch on the front of the controller is turned OFF.
- 2) Connect the machine cable to its corresponding connector on the robot arm side.
- 3) After connecting the connector, insert the hook attached to the connector on the machine cable side to the rear of the projection of the robot arm connector to fix securely in place.



⚠ CAUTION Be careful not to get your hand pinched.



- 4) To remove the cable, insert a minus screwdriver into the hook while padding with a cloth, and remove the cable by lifting the hook.

⚠ CAUTION The machine cable connectors are dedicated for the controller side and robot arm side, so take special care when connecting. If connected incorrectly, the connector pins could bend or break. Thus, even if connected correctly, the robot will not operate correctly, creating a dangerous situation.

⚠ CAUTION Take special care to the leading of the connection cable. If the cable is pulled with force or bent excessively, wires could break or the connector could be damaged.

⚠ CAUTION Please be careful not to catch the hand at installation and removal.

2.2.7 Procedure for wiring the hand output cables

The hand output cables (GR1 and GR2) are coming out from the rear of the No. 2 arm. If these cables are not used, put the cables inside the arm according to the following procedure.

The procedure for using these cables are described in "3 Installing the option devices" on page 47. Please handle accordingly by referencing this section when installing the solenoid valve.

■ Procedure for handling the hand output cables



- 1) When the robot is shipped, the hand output cables are coming out from the rear of the No. 2 arm.

Insert the cables.



- 2) Insert the connector into the back of the No. 2 arm.

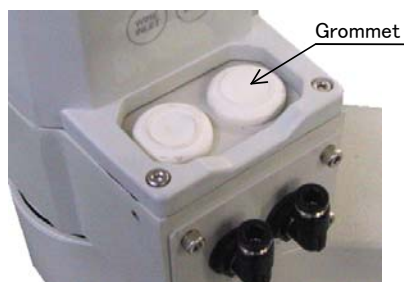

- 3) Install the grommets that come with the product to the robot.



- 4) Fill the surrounding areas of the grommets with silicon rubber.

Fig.2-8 : Procedure for handling the hand output cables

The interior of the spare wiring (AWG#24(0.2mm²) x4 pair (a total of eight cores) cable is carried out to the robot arm from the base portion to the No.2 arm rear piece. The customer can use this wire. In this case, the cable clamp (refer to the following) is needed separately for wiring leading about out of the robot. Please prepare of the customer in advance.

2.2.8 No.2 arm area

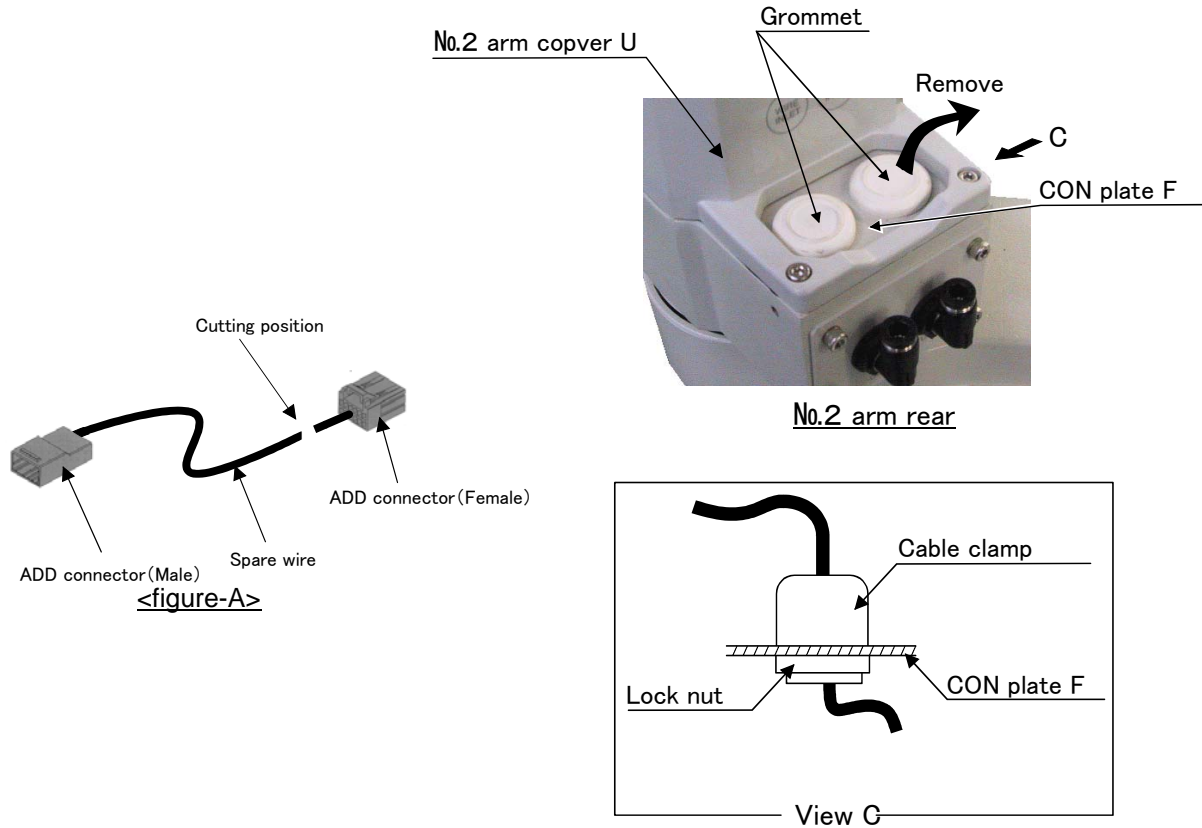

Fig.2-9 : Drawer of spare wiring (No.2 arm side)

- 1) Remove safety socket (RH-6SDH: M 4 x 10: 10 bolts, RH-12SDH/18SDH/20SDH: M 4 x 10: 11 bolts) which has stopped No.2 arm-cover U and remove the cover.
- 2) Remove safety socket M 4 x 10: 2 bolts which has stopped CON plate F and remove the plate.
- 3) Remove one either between the two grommets in the CON plate F. After removing the grommet, the seal material which remained in the hole section removes.
- 4) Take out the spare wiring (ADD) stored in the cover. (The spare wiring by the side of the fore arm is separable by the connector)
- 5) Since spare wiring is bundled in the union band, it removes the union band.
- 6) The connector is attached to spare wiring to both ends. Cut spare wiring near the connector (from the connector end to the about 10-20mm Refer to <figure-A> in Fig. 2-9), and let spare wiring pass to the cable clamp (customer preparation).
- 7) Fix the cable clamp to the hole section of the CON plate F securely with the lock nut.
- 8) Connect "ADD" of the pulled-out spare wiring with the connector of "ADD" stored in the cover.
- 9) Install the CON plate F as before. Be careful not to insert the cable
- 10) Install the No.2 arm cover U as before. At this time check packing not broken or not stripped.

CAUTION

When pulling out spare wiring, keep big power from being added to the cable, the air hose.

CAUTION

Please check packing not being broken or not having stripped at the time of cover installing and removing. Please contact the dealer, if it is broken or has stripped. If you use it, packing broken or stripped, oil mist etc. will invade in the arm and will cause failure.

⚠ CAUTION

When No.2 arm-cover U or the CON plate F are installed, please keep too much load from being applied to the cables inside the robot, and the air hoses. If too much load is added, the breaking of a wire and the air hose break, and the robot cannot operate normally.

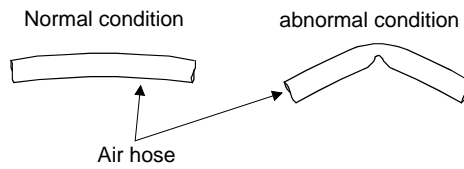
**⚠ CAUTION**

When No.2 arm-cover U or the CON plate F are installed, catch neither the cable nor the air hose. If the bolt is tightened while it had been caught, the breaking of a wire and the air hose break, and the robot cannot operate normally. Moreover, packing does not stick and protection specification cannot be secured.

2.2.9 Base area

1) Remove installation bolt and remove CONBOX cover.

! CAUTION

CONBOX cover is completely inseparable with the robot arm. When you install and remove the cover, be careful of the cable etc. If too much power is applied, the robot may malfunction by the breaking of the cable.

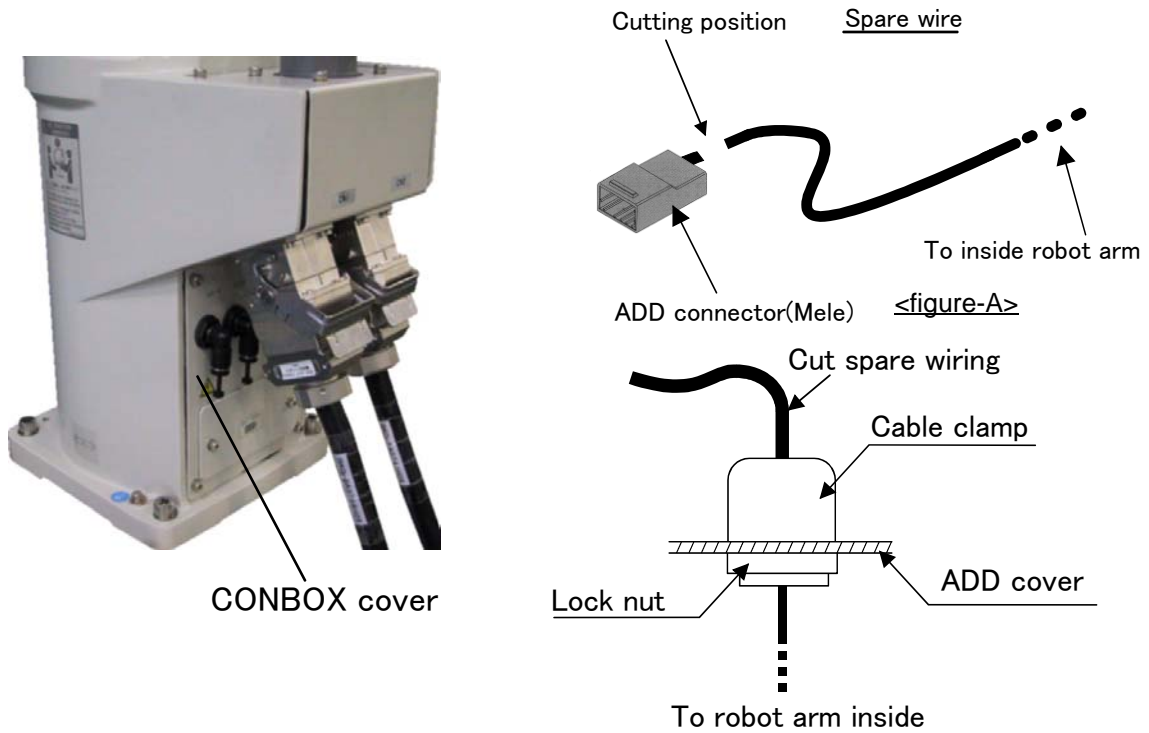

Fig.2-10 : Pull out spare wiring(Base area)

- 2) Move CONBOX cover and secure the access space to spare wiring. Be careful of the cables and air hoses which are connected into the robot arm.
- 3) Take out spare wiring(ADD). Spare wiring of this part is inseparable.
- 4) Remove the union band of spare wiring.
- 5) Cut spare wiring near the connector (from the connector end to the about 10-20mm. Refer to figure-A in Fig. 2-10)
- 6) Remove the grommet of CONBOX cover. Remove the seal material which remained in the hole area of the metal plate .
- 7) Remove the lock nut of attachment in the cable clamp (customer preparation).
- 8) Let spare wiring pass from the robot arm side of CONBOX cover in the hole after removing the grommet. Let the lock nut pass to spare wiring previously at this time.
- 9) The tip area of spare wiring pass to the cable clamp. And fix with the lock nut securely.

! CAUTION

When pulling out spare wiring, keep big power from being added to the cable, the air hose.

! CAUTION

Please check packing not being broken or not having stripped at the time of cover installing and removing. Please contact the dealer, if it is broken or has stripped. If you use it, packing broken or stripped, oil mist etc. will invade in the arm and will cause failure.

⚠ CAUTION

When CONBOX cover is installed, please keep too much load from being applied to the cables and the air hoses. If too much load is applied, the cable will be broken and the hose is bent, therefore robot and pneumatic drive equipment cannot operate normally.

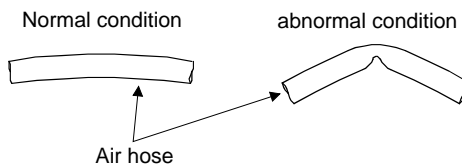
**⚠ CAUTION**

When No.2 arm-cover U or the CON plate F are installed, catch neither the cable nor the air hose.

If the bolt is tightened while it had been caught, the cable will be broken and the hose is bent, and the robot and pneumatic drive equipment cannot operate normally. Moreover, packing does not stick and protection specification cannot be secured.

2.2.10 Connection of piping for air pressurization

In use in oil mist environment, protection performance can be improved by pressurizing the inside of the robot arm. Please connect the phi8 air hose to the joint for pressurization of the robot arm base portion "AIR PURGE", and pressurize the inside of the robot arm.

Refer to the section of "Protection specification and the environment" of the "Standard specifications" separate volume.

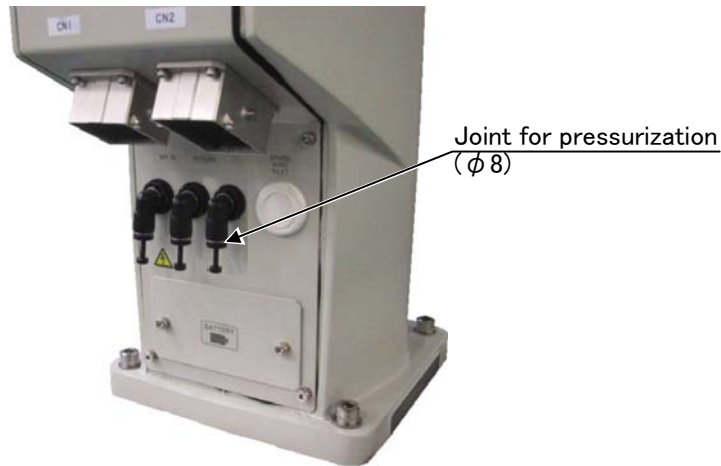

Fig.2-11 : Air purge

2.2.11 Connection of piping for suction

In use of the robot of clean specification, please connect the phi8 air hose to the joint for suction of the robot body base portion "VACUUM", and suck the inside of the robot body.

Refer to the section of "Clean specification" of the "Standard specifications" separate volume.

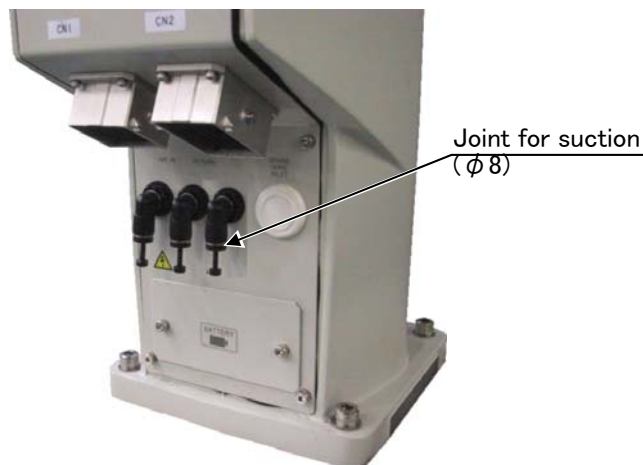

Fig.2-12 : Vacuum

2.3 Setting the origin

The origin is set so that the robot can be used with a high accuracy. After purchasing the robot, always carry out this step before starting work. This step must also be carried out if the combination of robot and controller being used is changed.

There are several methods for setting the origin, but the origin data input method will be explained here. Refer to "5.6 Resetting the origin" on page 83 for the other methods.

The teaching pendant is required for this operation.

[Caution] If the origin data at shipment is erased due to out of battery, it is necessary to set the origin again. Refer to "5.6 Resetting the origin" on page 83 and reset the origin using the jig method or ABS method.

2.3.1 Installing the teaching pendant (T/B)

When installing and removing the T/B, turn off the controller power supply. If T/B is installed or removed in the state of power supply ON, emergency stop alarm will occur.

If you use the robot wherein T/B is removed, please install the attached dummy connector. With the connector, put the dummy connector or draw it out.



CAUTION

Please do not pull the cable of T/B strongly or do not bend it too much.

It becomes the breaking of a wire of the cable and the cause of breakage of the connector. Please installing and removing so that stress does not start the cable with the connector itself.

Explain the installation method of T/B below.

- 1) Check that the POWER (power supply) switch of the robot controller is OFF.
- 2) Connects T/B connector to the robot controller. Use as the upper surface the lock lever shown in Fig. 2-13, and push in until there is sound.

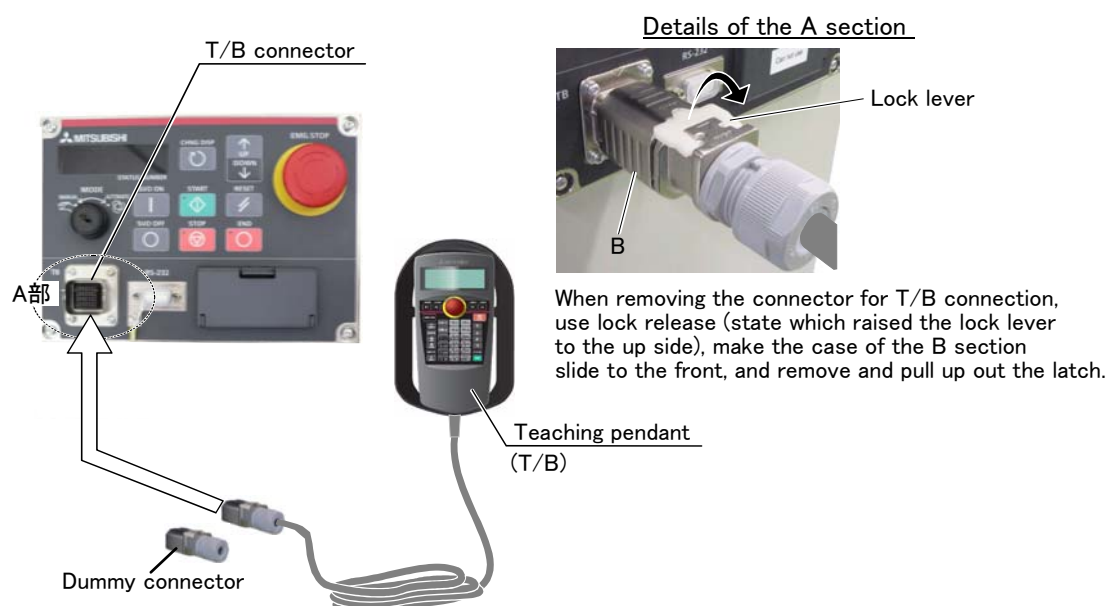

Fig.2-13 : Installing and removing the T/B

The installation of T/B is finished.

◆◆◆ If error C0150 occurs ◆◆◆

At the time of the first power supply injection, error:C0150 (the serial number of the robot arm has not been set up) occur the robot after purchase.

Parameter: Please input the serial number of the robot body into RB SERIAL. Refer to "instructions manual / controller setup, and basic operation & maintenance" for the operation method.

2.3.2 Setting the origin with the origin data input method

(1) Confirming the origin data

● Origin data history table (Origin Data History) Serial No.ES804008

Date	Default
D	V!#S29			
J 1	06DTYY			
J 2	2?HL9X			
J 3	1CP55V			
J 4	T6!M\$Y			
J 5	Z2!J%Z			
J 6	A12%Z0			
Method	E	E · N · S P	E · N · S P	E · N · S P

(O: O(Alphabet), 0: Zero)

Note) Meanings of symbols in method column

E: Jig method

N: Not used

SP: Not used

The origin data to be input is noted in the origin data sheet enclosed with the arm, or on the origin data history table attached to the back side of the J1 cover. (Refer to Fig. 2-14).

Referring to “5.3.2 Installing/removing the cover” on page 60, remove the J1 cover and confirm the value.

The value given in the default setting column is the origin settings set with the calibration jig before shipment.

Fig.2-14 : Origin data label (an example)

* The origin data to input is found on also the robot examination report sheet.



WARNING

Always install/remove the cover with the controller control power turned OFF. Failure to do so could lead to physical damage or personal injury should the robot start moving due to incorrect operations.

(2) Turning ON the control power



CAUTION

Confirm that there are no operators near the robot before turning the power ON.

1) Turn the controller [POWER] switch ON.

The control power will be turned ON, and “o. 100” will appear on the STATUS NUMBER display on the front of the controller.

(3) Preparing the T/B

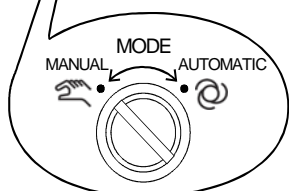

Next, prepare to use the T/B

1) Set the [MODE] switch on the front of the controller to "MANUAL".

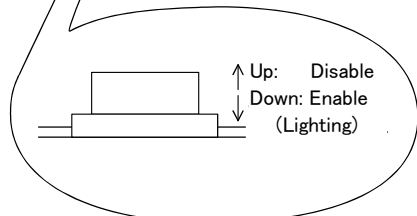

2) Set the T/B [ENABLE] switch to "ENABLE". The menu selection screen will appear.

The following operations are carried out with the T/B.

◆◆◆ Operating from the T/B ◆◆◆

Always set the [MODE] switch (mode selection key switch) on the front of the controller to "MAMNUAL", and then set the T/B [ENABLE] switch to "ENABLE".

When the T/B is valid, only operations from the T/B are possible. Operations from the controller or external signals will not be accepted.

(4) Selecting the origin setting method

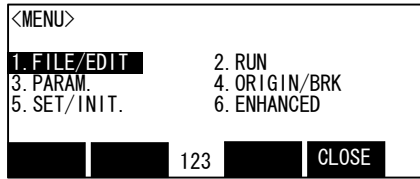

1) Press the [4] key on the menu screen, and display the ORIGIN/BRAKE screen.

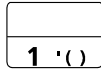
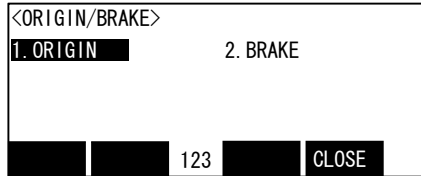

2) Press the [1] key on the ORIGIN/BRAKE screen, and display the origin setting method selection screen.

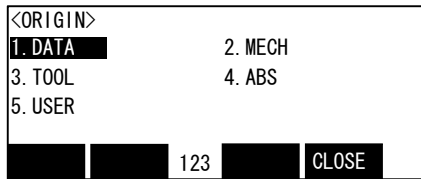

3) Press the [1] key on the origin setting method selection screen, and select the data input method.

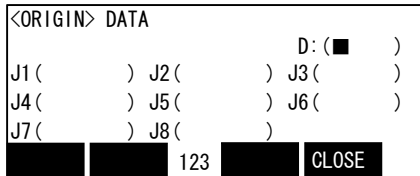

4) Display the origin data input screen

◆◆◆ Selecting a menu ◆◆◆

The menu can be selected with one of the following methods.

A: Press the numeral key for the No. of the item to be selected.

B: Using the [↓] and [↑] keys, etc., move the cursor to the item to be selected, and then press the [INP] key.

◆◆◆ The input method of numeral ◆◆◆

The number can be inputted if the key displayed on the lower left of each key is pressed. Press the [CHARACTER] key, and in the condition that "123" is displayed on the screen lower side, press the number key.

(5) Inputting the origin data



Input the value confirmed in section “(1) Confirming the origin data” on page 22.

The correspondence of the origin data label value and axis to be input is shown in Fig. 2-15.

Fig.2-15 : Correspondence of origin data label and axis

The method for inputting the origin data is explained below. The value shown in Fig. 2-14 will be input as an example.

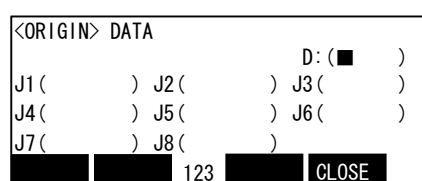

1) Confirm that the cursor is at the “D” position on the T/B display screen.

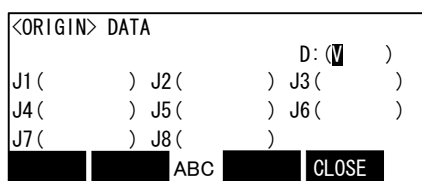

CHARACTER

-B (J5)
8 TUV

2) Input the D value “V!%S29”.

Inputting “V”

Press the [CHARACTER] key and set to the character input mode. (Condition that “ABC” was displayed under the screen)

Press the [TUV] key three times. “V” will be set.

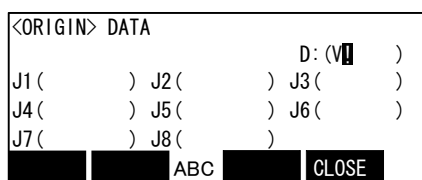

+C (J6)
. , %

→

+C (J6)
. , %

Inputting “!”

Press the [, %] key five times. “!” will be set.

Press the [→] key once and advance the cursor.

Press the [, %] key twice (input “%”), and press the [PQRS] key four times (input “S”).

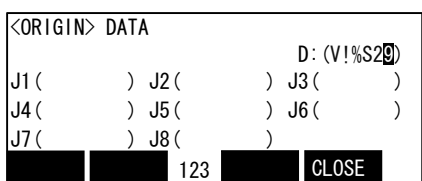

CHARACTER

-Z (J3)
2 ABC

+B (J5)
9 WXYZ

Press the [CHARACTER] key and set to the numeral input mode. (Condition that “123” was displayed under the screen)

Press the [2] key (input “2”), and press the [9] key (input “9”).

“V!%S29” will appear at the “D” data on the teaching pendant screen.

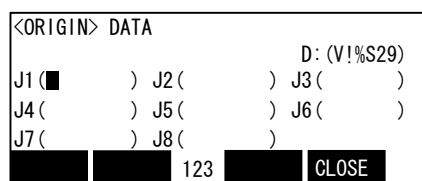

↓

:
:
:

3) Press the [↓] key, and move the cursor to the J1 input position.

4) Input the J1 value in the same manner as above.

Input the J2, J3, J4, J5 and J6 values in the same manner.

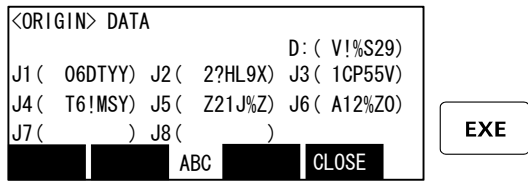

5) After inputting all of the values, press the [EXE] key. The origin setting confirmation screen will appear.

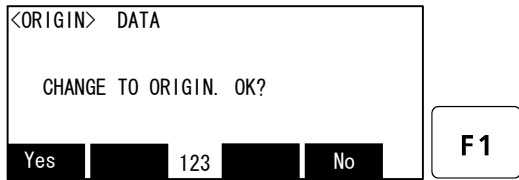

6) Press [F1] (Yes) to end the origin setting

◆◆◆ Moving the cursor ◆◆◆
Press the [↑], [↓], [←] and [→] keys.

◆◆◆ Inputting characters ◆◆◆
Press the [CHARACTER] key and set to the character input mode. (Condition that "ABC" was displayed under the screen). The displayed character is scrolled each time at pressing the key.

◆◆◆ Correcting an input ◆◆◆
After returning one character by pressing the [C L E A R] key, input the character again.

(6) Installing the J1 cover.

Return the J1 cover removed in section "(1) Confirming the origin data" on page 22 to its original position. This completes the setting of the origin with the origin data input method.



WARNING

Always remove and install the cover with the controller power turned OFF. Failure to do so could lead to the robot moving because of incorrect operations, or to physical damage or personal injury.

◆◆◆ If the origin input data is incorrect ◆◆◆
If the origin input data is incorrect, the alarm No. 1760 (origin setting data illegal) will occur when origin data input. In this case, reconfirm the value input for the origin data.

2.4 Confirming the operation

In this section, the robot will be moved manually using the T/B to confirm that the operation is correct. Moving the robot manually is called "jog operation". This operation includes the JOINT jog that moves each axis, the XYZ jog that moves along the base coordinate system, the TOOL jog that moves along the tool coordinate system, and the CYLINDER jog that moves along the circular arc.

This operation is carried out while pressing the deadman switch on the back of the T/B.

CAUTION The robot will move during this operation. Make sure that there are no operators near the robot, and that there are no obstacles, such as tools, in the robot operation range.

CAUTION To immediately stop the robot, release the deadman switch on the back of the T/B. The servo power will turn OFF, and the robot will stop. The robot will also stop if the [EMG.STOP] switch (emergency stop switch) on the front of the T/B or the [EMG.STOP] switch (emergency stop) on the front of the controller is pressed.

WARNING Confirm that the origin has been set. If the origin has not been set, "****" will appear at the current position display on the teaching pendant, the JOINT jog operation will take place in any jog mode selected.

Refer to "2.3 Setting the origin" on page 21 for details on setting the origin.

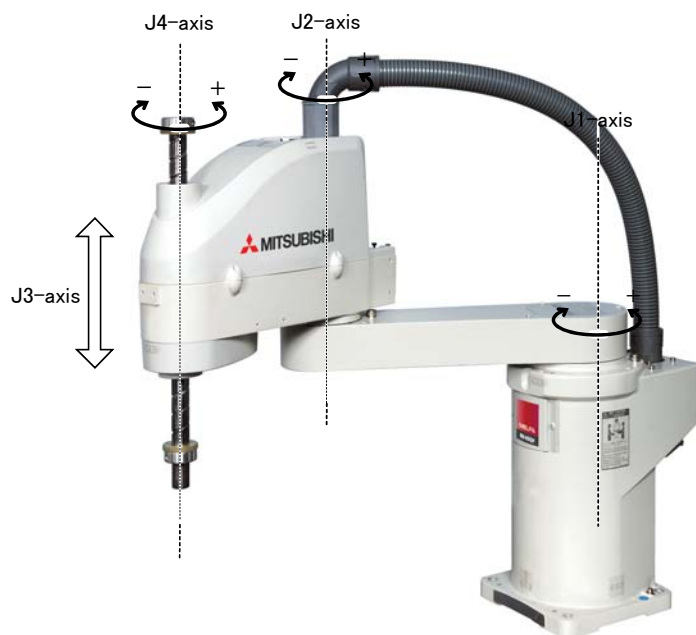

* Each axis moves independently.

Fig.2-16 : JOINT jog operation

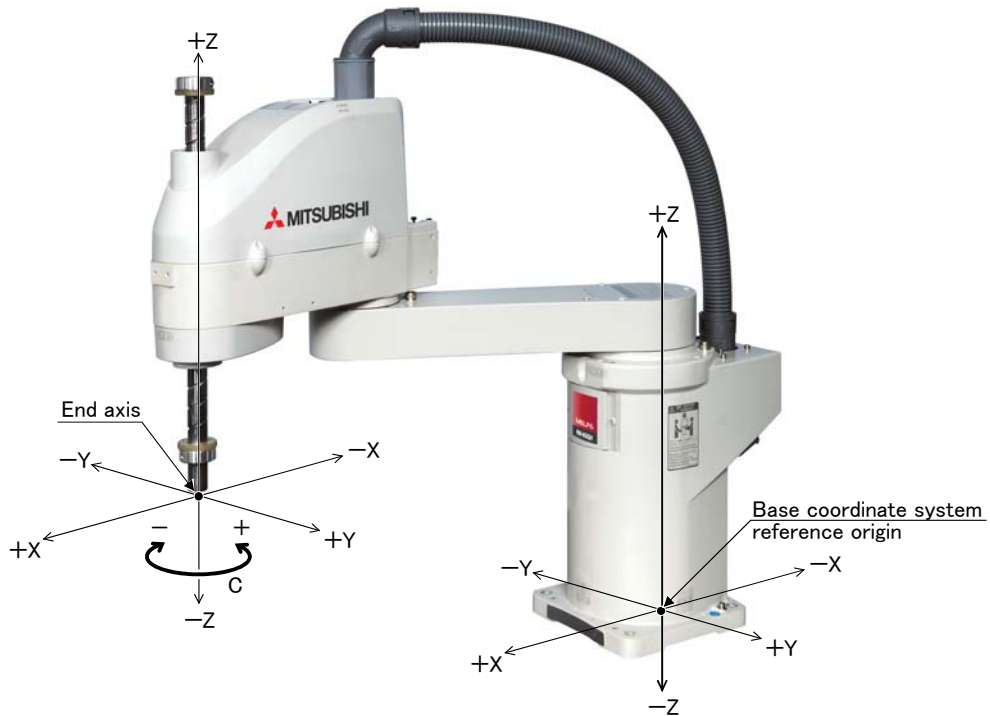

* While maintaining the end axis posture, the axis moves straight along the base coordinate system.
Also, while maintaining the end axis position, the end axis posture changes..

Fig.2-17 : XYZ jog operation

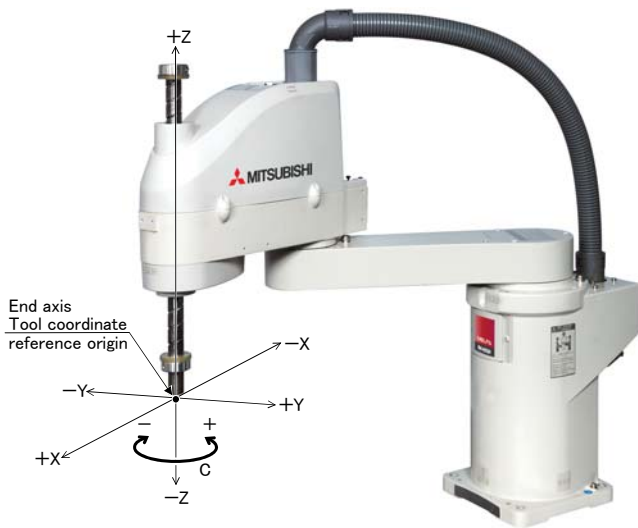

* While maintaining the end axis posture, the axis moves straight along the tool coordinate system.
Also, while maintaining the end axis position, the end axis posture changes

Fig.2-18 : TOOL jog operation

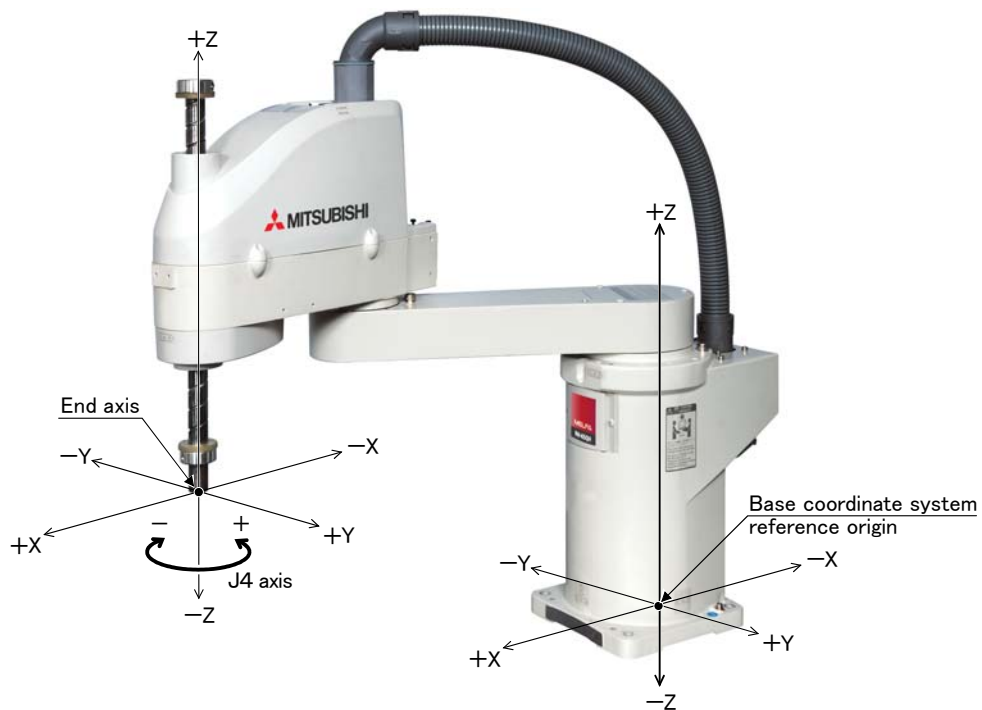

* The axis moves straight along the base coordinate system. At this time, the end axis posture is not maintained.
Also, the end axis posture changes.

Fig.2-19 : 3-axis XYZ jog operation



* The current position is set as the arc centering on the Z axis, and the axis moves along that arc, expands and contracts in the radius direction, and moves vertically. At this time, the end axis posture is maintained. Also, while maintaining the axis posture position, the end axis posture changes.

Fig.2-20 : CYLINDER jog operation

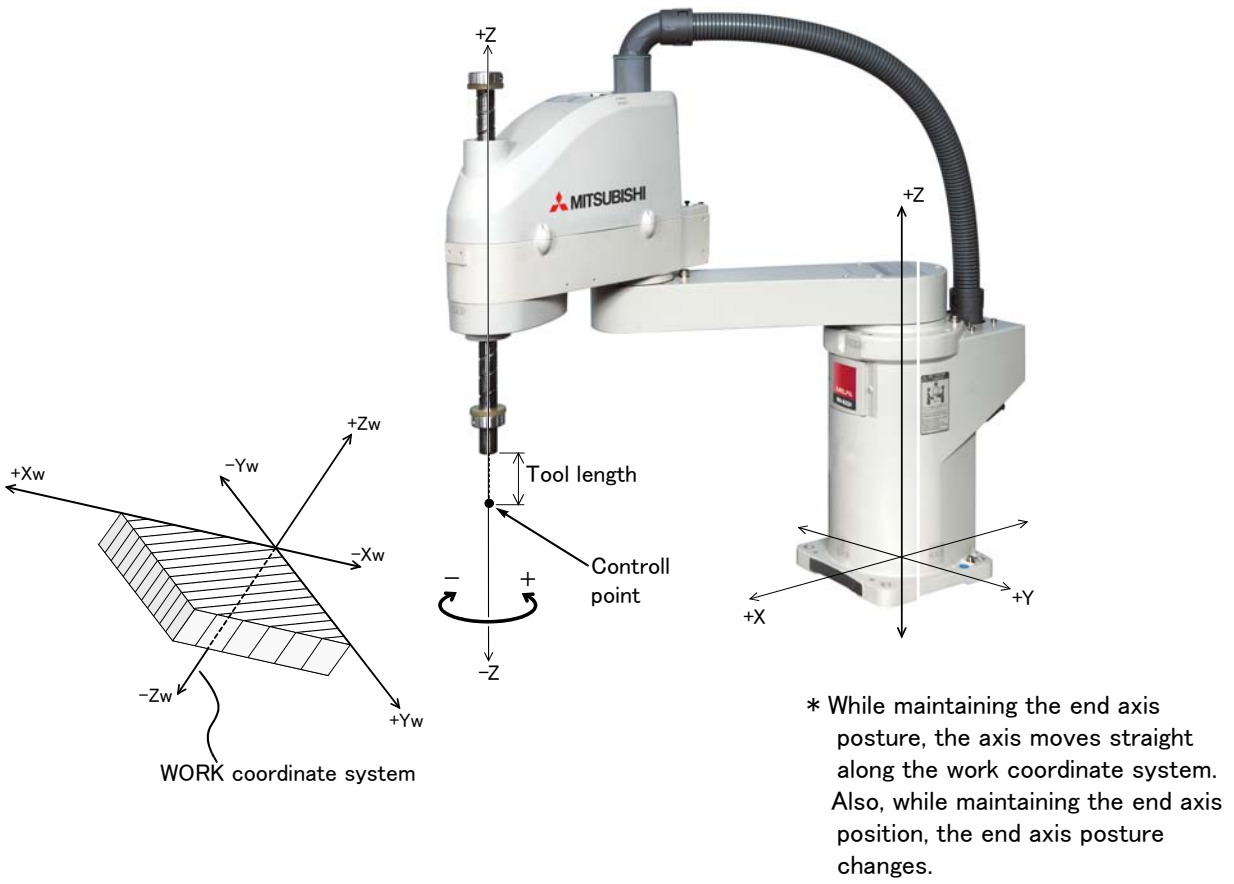
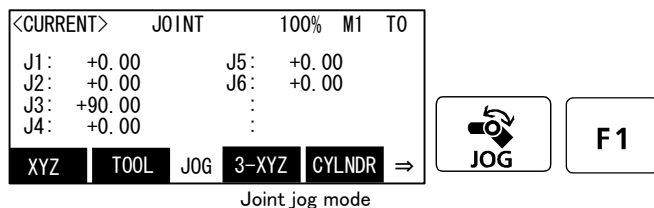
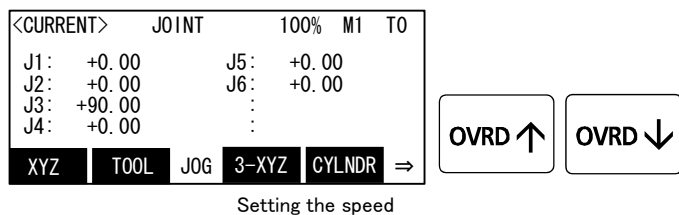

Fig.2-21 : WORK jog operation

(1) JOINT jog operation

Select joint jog modeSet jog speed

[JOG] Press the key and display the jog screen. ("JOG" is displayed on the screen bottom)

Check that the "joint" in jog mode is displayed on the screen.

If other jog modes are displayed, please press the function key corresponding to the "joint." (If the jog mode which he wishes under the screen is not displayed, it is displayed that the [FUNCTION] key is pressed)

If it finishes jog operation, press the [JOG] key again, or function key which correspond to "close."

Whenever it presses the key of [OVRD ↑], the override goes up. Conversely, if the [OVRD ↓] key is pressed, it will go down.

The current setting speed is displayed on screen upper right, and "STATUS NUMBER" of the controller.

Set the override to 10% here for confirmation work

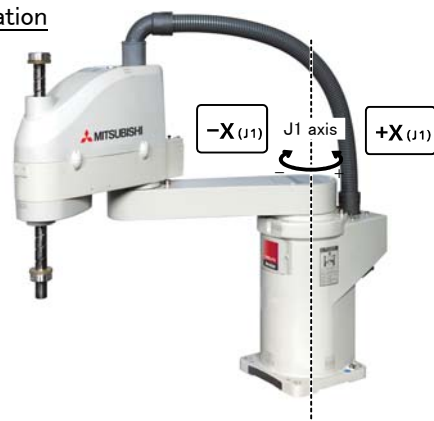
J1 axis jog operation

- When the [+X (J1)] keys are pressed, the J1 axis will rotate in the plus direction.
When the [-X (J1)] keys are pressed, Rotate in the minus direction.

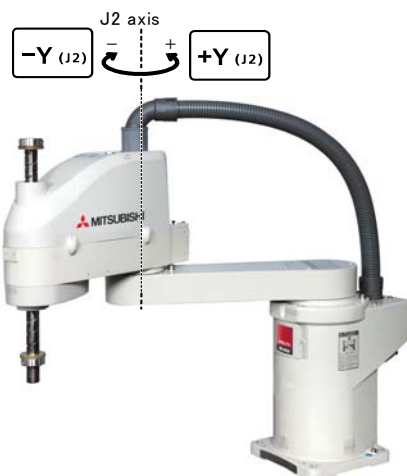
J2 axis jog operation

- When the [+Y (J2)] keys are pressed, the J2 axis will rotate in the plus direction.
When the [-Y (J2)] keys are pressed, Rotate in the minus direction.

◇◆◇ When the robot is in the transportation posture ◇◆◇
The axes may be outside the movement area. Move these axes toward the inner side of the movement area.

J3 axis jog operation

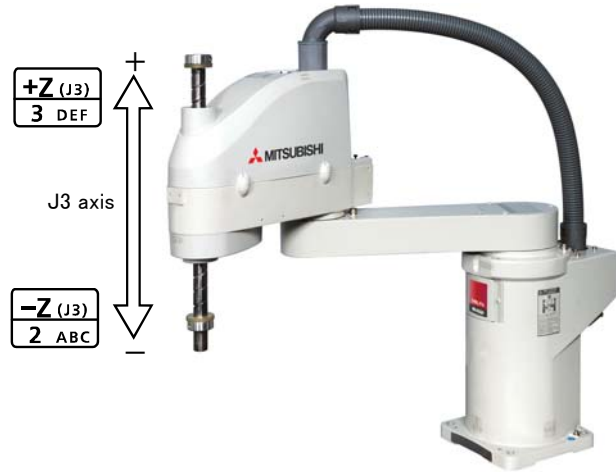

- When the [+Z (J3)] keys are pressed, the J3 axis will rotate in the plus direction.
When the [-Z (J3)] keys are pressed, Rotate in the minus direction.

J4 axis jog



- When the [+A (J4)] keys are pressed, the J4 axis will rotate in the plus direction.
When the [-A (J4)] keys are pressed, Rotate in the minus direction.

◇◆◇ If the buzzer of T/B sounds and the robot does not move ◇◆◇
If it is going to move the robot across the operation range, the buzzer of T/B sounds and the robot does not move. In this case, please move to the counter direction.

(2) XYZ jog operation

Select XYZ jog mode

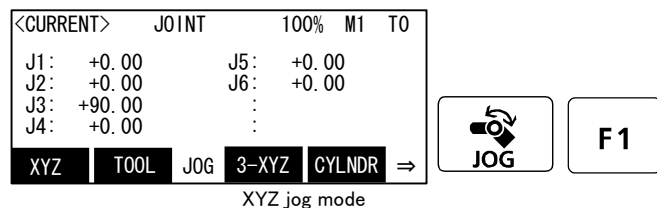

Set jog speed

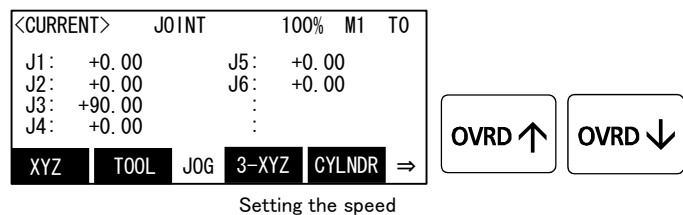

[JOG] Press the key and display the jog screen. ("JOG" is displayed on the screen bottom)

Check that the "XYZ" in jog mode is displayed on the screen.

If other jog modes are displayed, please press the function key corresponding to the "XYZ." (If the jog mode which he wishes under the screen is not displayed, it is displayed that the [FUNCTION] key is pressed)

If it finishes jog operation, press the [JOG] key again, or function key which correspond to "close."

Whenever it presses the key of [OVRD ↑], the override goes up. Conversely, if the [OVRD ↓] key is pressed, it will go down.

The current setting speed is displayed on screen upper right, and "STATUS NUMBER" of the controller.

Set the override to 10% here for confirmation work

Moving along the base coordinate system



*The direction of the end axis will not change.

- When the [+X (J1)] keys are pressed, the robot will move along the X axis plus direction.
When the [-X (J1)] keys are pressed, Move along the minus direction.
- When the [+Y (J2)] keys are pressed, the robot will move along the Y axis plus direction.
When the [-Y (J2)] keys are pressed, Move along the minus direction.
- When the [+Z (J3)] keys are pressed, the robot will move along the Z axis plus direction.
When the [-Z (J3)] keys are pressed, Move along the minus direction.

◆◆◆ When the robot is in the transportation posture ◆◆◆

There are directions from which linear movement is not possible from the transportation posture. In this case, the robot will not move. Refer to section "(1) JOINT jog operation" on page 31", and move the robot to a position where linear movement is possible, and then carry out XYZ jog.

◆◆◆ If the buzzer of T/B sounds and the robot does not move ◆◆◆
If it is going to move the robot across the operation range, the buzzer of T/B sounds and the robot does not move. In this case, please move to the counter direction.

Changing the end axis posture

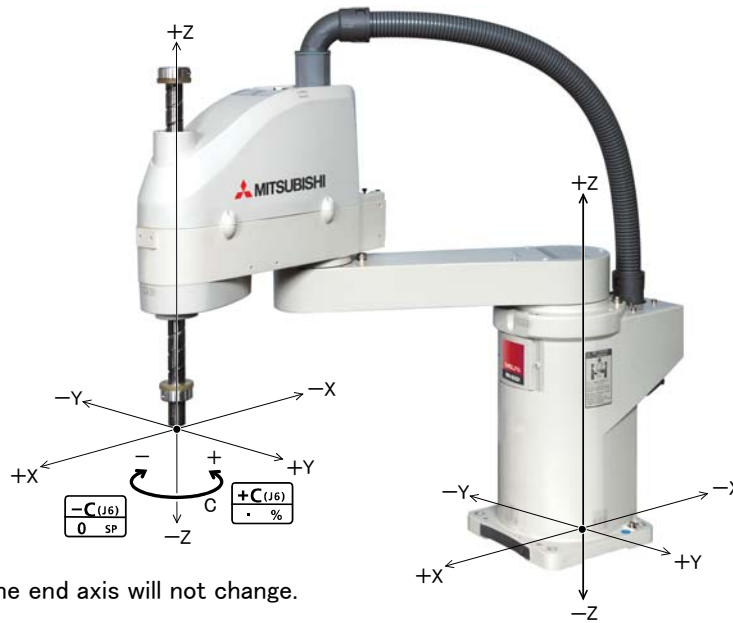

- When the [+C (J6)] keys are pressed, The Z axis will rotate in the plus direction.
When the [-C (J6)] keys are pressed, Rotate in the minus direction.

◆◆◆ When alarm No. 5150 occurs ◆◆◆
If alarm No. 5150 (ORIGIN NOT SET) occurs, the origin has not been set correctly. Reconfirm the value input for the origin data.

◆◆◆ Tool length ◆◆◆
The default tool length is 0mm, and the control point is the center of the end axis.
After installing the hand, set the correct tool length in the parameters. Refer to the separate manual "Detailed Explanation of Functions and Operations" for details.

(3) TOOL jog operation

Select TOOL jog mode

<CURRENT>	JOINT	100%	M1	TO
J1: +0.00	J5: +0.00			
J2: +0.00	J6: +0.00			
J3: +90.00	:			
J4: +0.00	:			

XYZ TOOL JOG 3-XYZ CYLNR =>

TOOL jog mode

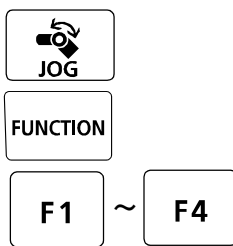

Set jog speed

<CURRENT>	JOINT	100%	M1	TO
J1: +0.00	J5: +0.00			
J2: +0.00	J6: +0.00			
J3: +90.00	:			
J4: +0.00	:			

XYZ TOOL JOG 3-XYZ CYLNR =>

Setting the speed

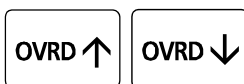

[JOG] Press the key and display the jog screen. ("JOG" is displayed on the screen bottom)

Check that the "TOOL" in jog mode is displayed on the screen.

If other jog modes are displayed, please press the function key corresponding to the "TOOL." (If the jog mode which he wishes under the screen is not displayed, it is displayed that the [FUNCTION] key is pressed)

If it finishes jog operation, press the [JOG] key again, or function key which correspond to "close."

Whenever it presses the key of [OVRD ↑], the override goes up. Conversely, if the [OVRD ↓] key is pressed, it will go down.

The current setting speed is displayed on screen upper right, and "STATUS NUMBER" of the controller.

Set the override to 10% here for confirmation work

Moving along the tool coordinate system

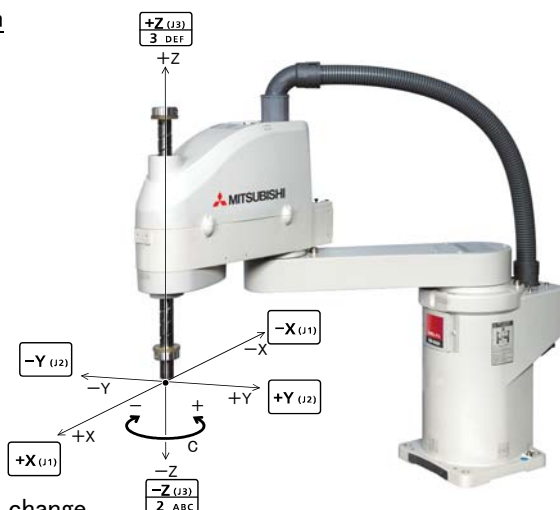

*The direction of the end axis will not change.

- When the [+X (J1)] keys are pressed, the robot will move along the X axis plus direction of the tool coordinate system.
When the [-X (J1)] keys are pressed, Move along the minus direction.
- When the [+Y (J2)] keys are pressed, the robot will move along the Y axis plus direction of the tool coordinate system.
When the [-Y (J2)] keys are pressed, Move along the minus direction.
- When the [+Z (J3)] keys are pressed, the robot will move along the Z axis plus direction of the tool coordinate system.
When the [-Z (J3)] keys are pressed, Move along the minus direction.

◆◆◆ When the robot is in the transportation posture ◆◆◆

There are directions from which linear movement is not possible from the transportation posture. In this case, the robot will not move. Refer to section "(1) JOINT jog operation" on page 31", and move the robot to a position where linear movement is possible, and then carry out XYZ jog.

◆◆◆ If the buzzer of T/B sounds and the robot does not move ◆◆◆
If it is going to move the robot across the operation range, the buzzer of T/B sounds and the robot does not move. In this case, please move to the counter direction.

Changing the end axis posture



*The Position of the end axis will not change.

- When the [+C (J6)] keys are pressed, The Z axis will rotate in the plus direction of the tool coordinate system.
When the [-C (J6)] keys are pressed, Rotate in the minus direction.

◆◆◆ When alarm No. 5150 occurs ◆◆◆
If alarm No. 5150 (ORIGIN NOT SET) occurs, the origin has not been set correctly. Reconfirm the value input for the origin data.

◆◆◆ Tool length ◆◆◆
The default tool length is 0mm, and the control point is the center of the end axis.
After installing the hand, set the correct tool length in the parameters. Refer to the separate manual "Detailed Explanation of Functions and Operations" for details.

(4) 3-axis XYZ jog operation

Select XYZ456 jog mode

<CURRENT>	JOINT	100%	M1	TO
J1:	+0.00	J5:	+0.00	
J2:	+0.00	J6:	+0.00	
J3:	+90.00	:	:	
J4:	+0.00	:	:	

XYZ TOOL JOG 3-XYZ CYLNR =>

XYZ456 jog mode

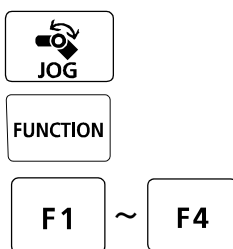

Set jog speed

<CURRENT>	JOINT	100%	M1	TO
J1:	+0.00	J5:	+0.00	
J2:	+0.00	J6:	+0.00	
J3:	+90.00	:	:	
J4:	+0.00	:	:	

XYZ TOOL JOG 3-XYZ CYLNR =>

Setting the speed



[JOG] Press the key and display the jog screen. ("JOG" is displayed on the screen bottom)

Check that the "XYZ456" in jog mode is displayed on the screen.

If other jog modes are displayed, please press the function key corresponding to the "XYZ456." (If the jog mode which he wishes under the screen is not displayed, it is displayed that the [FUNCTION] key is pressed)

If it finishes jog operation, press the [JOG] key again, or function key which correspond to "close."

Whenever it presses the key of [OVRD ↑], the override goes up. Conversely, if the [OVRD ↓] key is pressed, it will go down.

The current setting speed is displayed on screen upper right, and "STATUS NUMBER" of the controller.

Set the override to 10% here for confirmation work

Moving along the base coordinate system



*The direction of the end axis will change.

- When the [+X (J1)] keys are pressed, the robot will move along the X axis plus direction.
When the [-X (J1)] keys are pressed, Move along the minus direction.
- When the [+Y (J2)] keys are pressed, the robot will move along the Y axis plus direction.
When the [-Y (J2)] keys are pressed, Move along the minus direction.
- When the [+Z (J3)] keys are pressed, the robot will move along the Z axis plus direction.
When the [-Z (J3)] keys are pressed, Move along the minus direction.

◆◆◆ The flange surface end axis posture cannot be maintained with 3-axis XYZ jog. ◆◆◆
With 3-axis XYZ jog, the flange surface end axis posture (orientation) is not maintained when moving linearly in the X, Y or Z axis direction.
Use XYZ jog to maintain the posture.

Changing the end axis posture



*The Position of the end axis will not change.

- When the [+C (J6)] keys are pressed, the J4-axis will rotate in the plus direction.
When the [-C (J6)] keys are pressed, Rotate in the minus direction.

(5) CYLINDER jog operation

Select cylindrical jog mode

<CURRENT>	JOINT	100%	M1	TO
J1:	+0.00	J5:	+0.00	
J2:	+0.00	J6:	+0.00	
J3:	+90.00	:	:	
J4:	+0.00	:	:	

XYZ TOOL JOG 3-XYZ CYLNR =>

CYLINDER jog mode

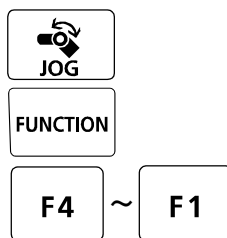

Set jog speed

<CURRENT>	JOINT	100%	M1	TO
J1:	+0.00	J5:	+0.00	
J2:	+0.00	J6:	+0.00	
J3:	+90.00	:	:	
J4:	+0.00	:	:	

XYZ TOOL JOG 3-XYZ CYLNR =>

Setting the speed

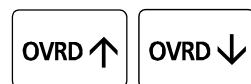

[JOG] Press the key and display the jog screen. ("JOG" is displayed on the screen bottom)

Check that the "CYLINDER" in jog mode is displayed on the screen.

If other jog modes are displayed, please press the function key corresponding to the "CYLINDER." (If the jog mode which he wishes under the screen is not displayed, it is displayed that the [FUNCTION] key is pressed)

If it finishes jog operation, press the [JOG] key again, or function key which correspond to "close."

Whenever it presses the key of [OVRD ↑], the override goes up. Conversely, if the [OVRD ↓] key is pressed, it will go down.

The current setting speed is displayed on screen upper right, and "STATUS NUMBER" of the controller.

Set the override to 10% here for confirmation work

Moving along an arc centering on the Z axis

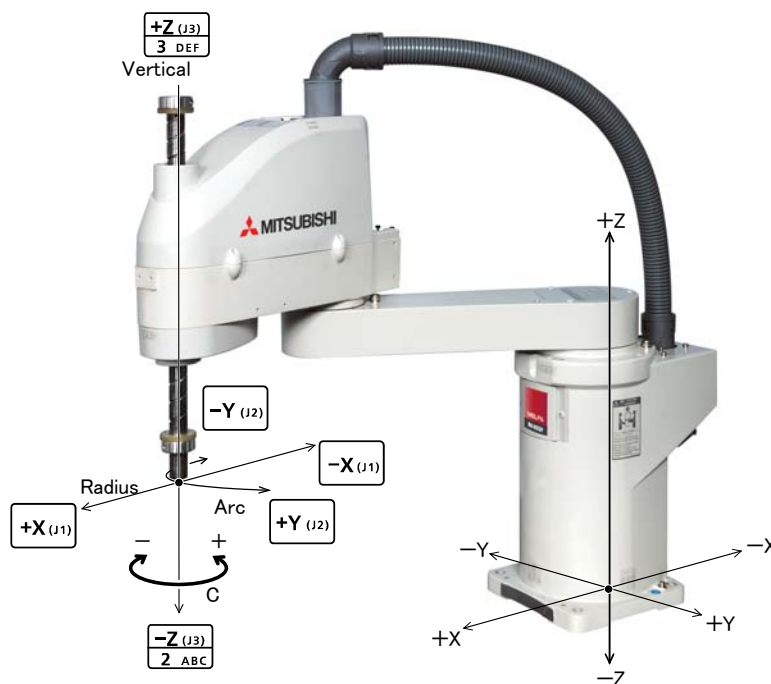

* The direction of the fringe will not change.

Assuming that the current position is on an arc centering on the Z axis, the robot moves along that arc.

- When the [+X (J1)] keys are pressed, the robot will expand in the radial direction.
When the [-X (J1)] keys are pressed, Contract in the radial direction.
- When the [+Y (J2)] keys are pressed, the robot will move along the arc in the plus direction.
When the [-Y (J2)] keys are pressed, Move in the minus direction.
- When the [+Z (J3)] keys are pressed, the robot will move along the Z axis plus direction.
When the [-Z (J3)] keys are pressed, Move along the minus direction.

Changing the flange surface posture

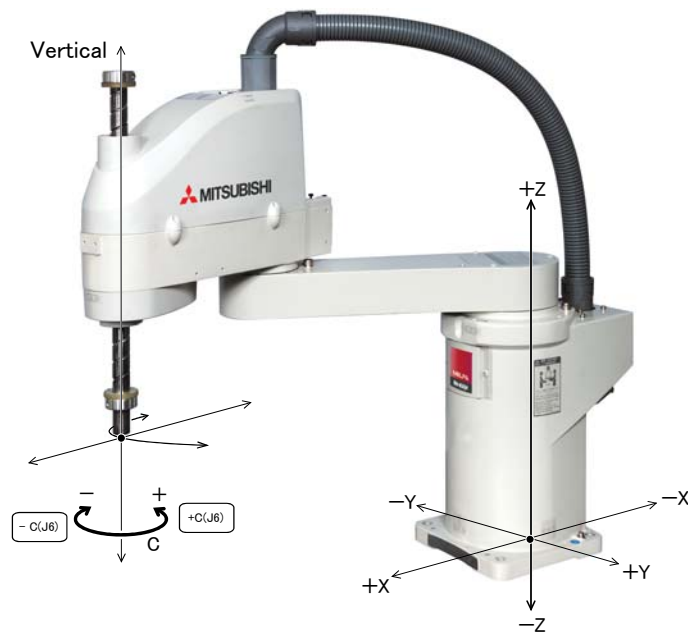

- When the [+C (J6)] keys are pressed, The Z axis will rotate in the plus direction.
When the [-C (J6)] keys are pressed, Rotates in the minus direction.

(6) Work jog operation

Setting of the work coordinates system is necessary.

By this jog operation, robot can be move along with the direction of work (or working table etc.), so teaching operations get easier.

When jog operation, select by which work coordinates the robot moves

The setting method of the work coordinates system using T/B (R32TB) is shown in the following.

(Parameter: Setting the coordinate value to WK n CORD ("n" is meaning the number (1-8) of work coordinates) can also set up the work coordinates system. Refer to the separate manual "Detailed Explanation of Functions and Operations" for details of parameter.)

In addition, this jog operation is available at the following software versions. The below-mentioned "6.ENHANCED" menu is not displayed in the other versions.

T/B :Ver.1.3 or later

SQ series: N8 or later

SD series :P8 or later

The work coordinates system teaches and sets up the three points (WO, WX, WY).

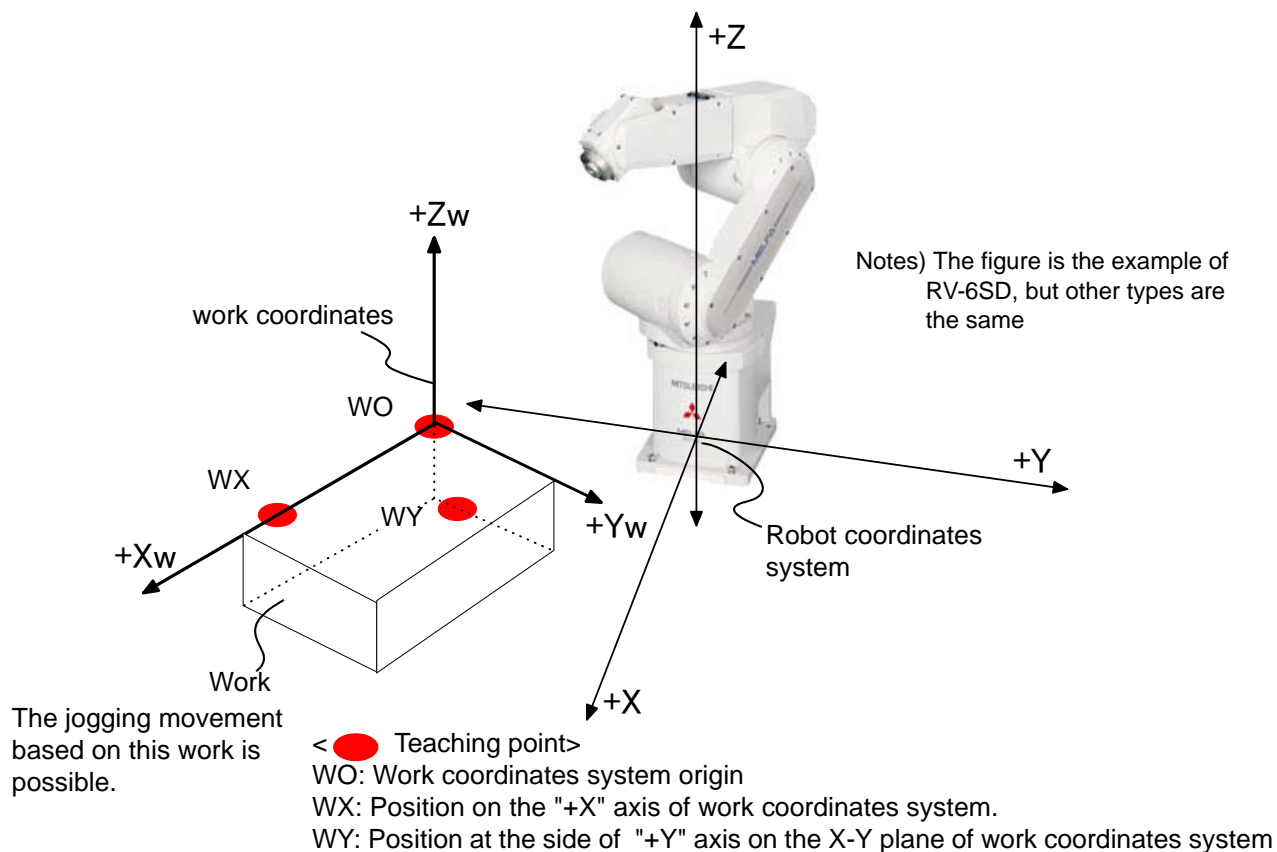

[Supplement] : The coordinate values which use all three teaching points for setting of the work coordinates system are each only X, Y, and the Z-axis. Although the coordinate value of A, B, and C axis is not used, positioning will get easy if the XYZ jog or TOOL jog movement is effected with the same value. (The direction of the hand is the same)

Fig.2-22 : Setting of the work coordinates system (teaching point)

The setting (definition) method of the work coordinates system is shown in the following.

1) Select "6.ENHANCED" screen on the <MENU> screen.

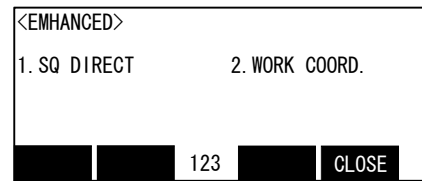
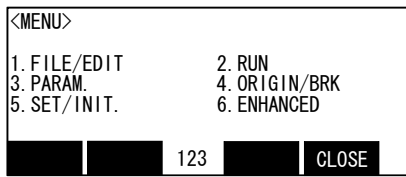

2) Press the [2] keys in the menu screen and select "2. xxxxx."

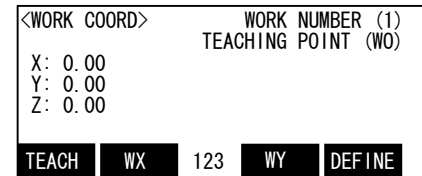
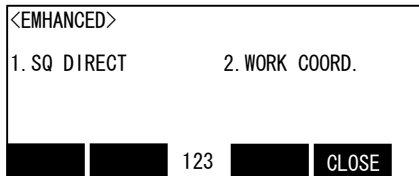

The screen shows the coordinate value of the origin (WO) of the work coordinates number 1.

3) Selection of the work coordinates number

Press the [FUNCTION] keys, and display "W: JUMP" function. Press the function key corresponding to "W: JUMP"

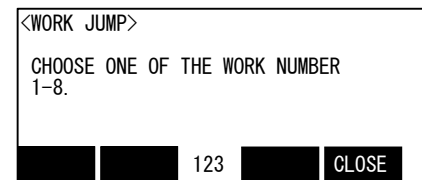
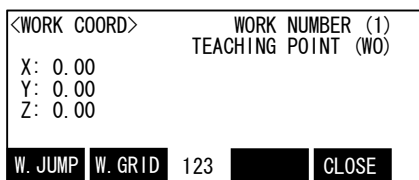

Press numeral key [1] - [8] and specify the work coordinates number. The coordinate value of the specified work coordinates system is displayed.

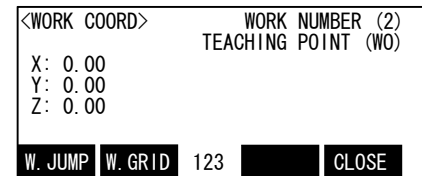
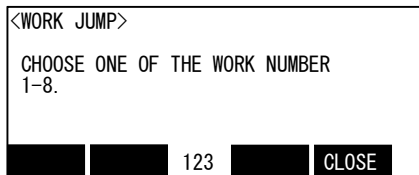

The screen is the example which specified the work coordinates number 2. ("2" at the upper right of the screen)

Operation will be canceled if the [CLOSE] key is pressed.

4) The teaching of the work coordinates system

Teach the three points shown in Fig. 2-22. Confirm the name currently displayed on the "TEACHING POINT" at the upper right of the screen. If it differs, press the function key corresponding to each point(WO, WX, WY) to teach. Move the robot's arm by jog operation (other jogging movement), and press the function key corresponding to "TEACH."([F1]) The confirmation screen is displayed.

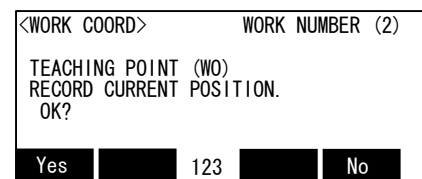
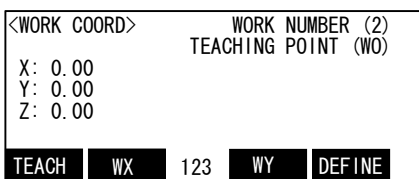

Specify the teaching point [WO],[WX],[WY] teaching the position [TEACH]

Presses the function key corresponding to "Yes", the robot's current position is registered, and the registered coordinates value is display. Operation will be canceled if the [CLOSE] key is pressed.

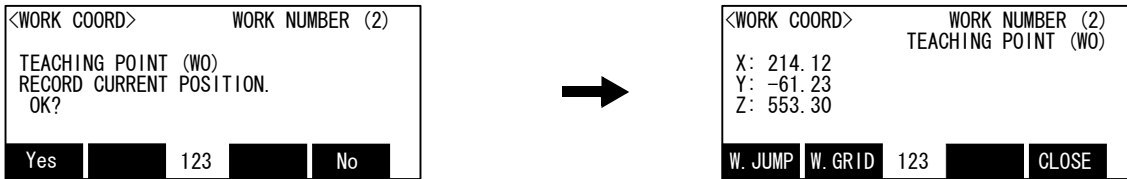

Teach the three points, WO, WX, and WY, by the same operation.

The position data taught here is each registered into the following parameters. ("n" means the work coordinates numbers 1-8)

WO= parameter: WKnWO

WX= parameter: WKnWX

WY= parameter: WKnWY

5) Setting of work coordinates (definition)

If the function key corresponding to "DEFINE" ([F1]) is pressed, the work coordinates system will be calculated using the three points, and the result will be displayed.

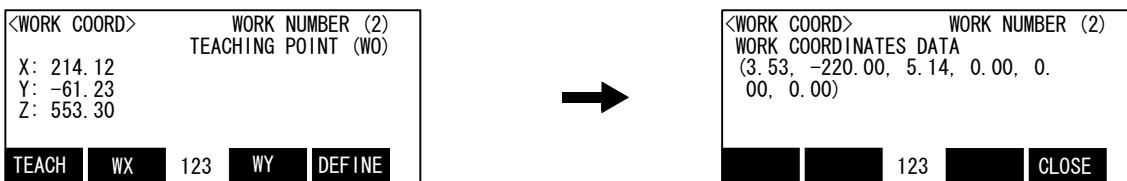

The alarm occurs if the work coordinates system is incalculable. (There are the three points on the straight line, or the two points have overlapped) In this case, reset alarm and re-teach the three points.

This work coordinate data is registered into parameter: WKnCORD. ("n" means the work coordinates numbers 1-8)

If the function key corresponding to "CLOSE" is pressed, it will return to the previous screen.

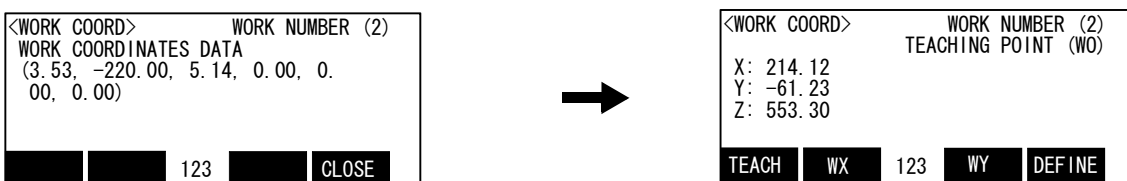

6) Finishing of setting the work coordinates

Press the [FUNCTION] keys, and display "CLOSE" function. Press the function key corresponding to "CLOSE". Returns to the <MENU> screen.

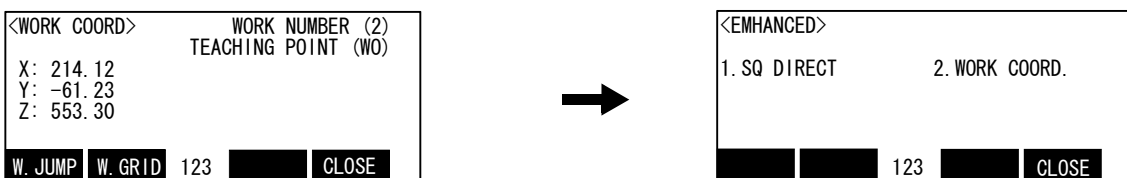

Although setting of work coordinates is finishing above, confirmation of work coordinates can be done by pressing the function key corresponding to "W GRID."([F2])

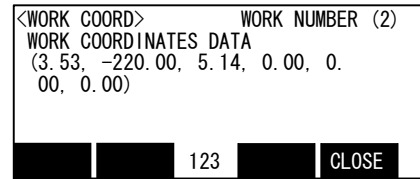
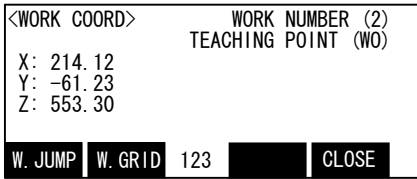

Return to the previous screen by pressing the [CLOSE] ([F4]) key.

Then, the operation method of the work jog is shown. Change to the work jog after nearing the work.

Select WORK jog mode

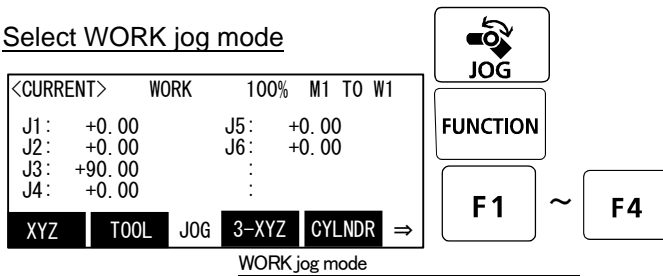

[JOG] Press the key and display the jog screen. ("JOG" is displayed on the screen bottom)

Check that the "WORK" in jog mode is displayed on the screen.

If other jog modes are displayed, please press the function key corresponding to the "WORK." (If the jog mode which he wishes under the screen is not displayed, it is displayed that the [FUNCTION] key is pressed)

If it finishes jog operation, press the [JOG] key again, or function key which correspond to "close."

Confirmation and selection of the work coordinates system

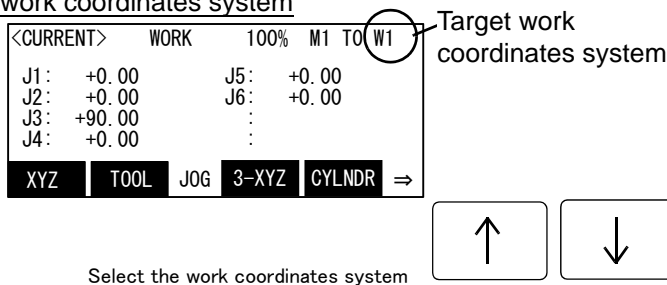

Confirm the target work coordinates system.

The current target number is displayed on the screen upper right. (W1~W8)

The number of work coordinates can be changed by the arrow key [Upper arrow], [Lower arrow]

Push the key [Upper arrow], the number will increase. (W1, W2, W8) Conversely, push the key [Lower arrow], the number will decrease

CAUTION

Always confirm that the number of the target work coordinates system is displayed correctly (Display of W1~W8 at the upper right of the screen)

If mistaken, the robot will move in the direction which is not meant and will cause the damage and the personal injuries.

Set jog speed

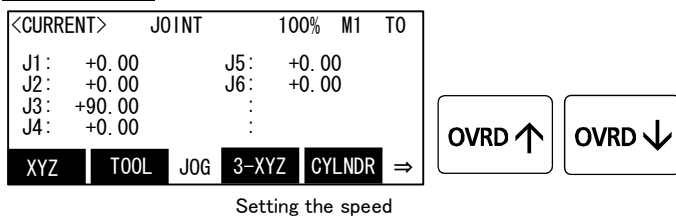

Whenever it presses the key of [OVRD(Upper arrow)], the override goes up. Conversely, if the [OVRD(Lower arrow)] key is pressed, it will go down.

The current setting speed is displayed on screen upper right, and "STATUS NUMBER" of the controller.

Set the override to 10% here for confirmation work

The jog movement based on work coordinates system

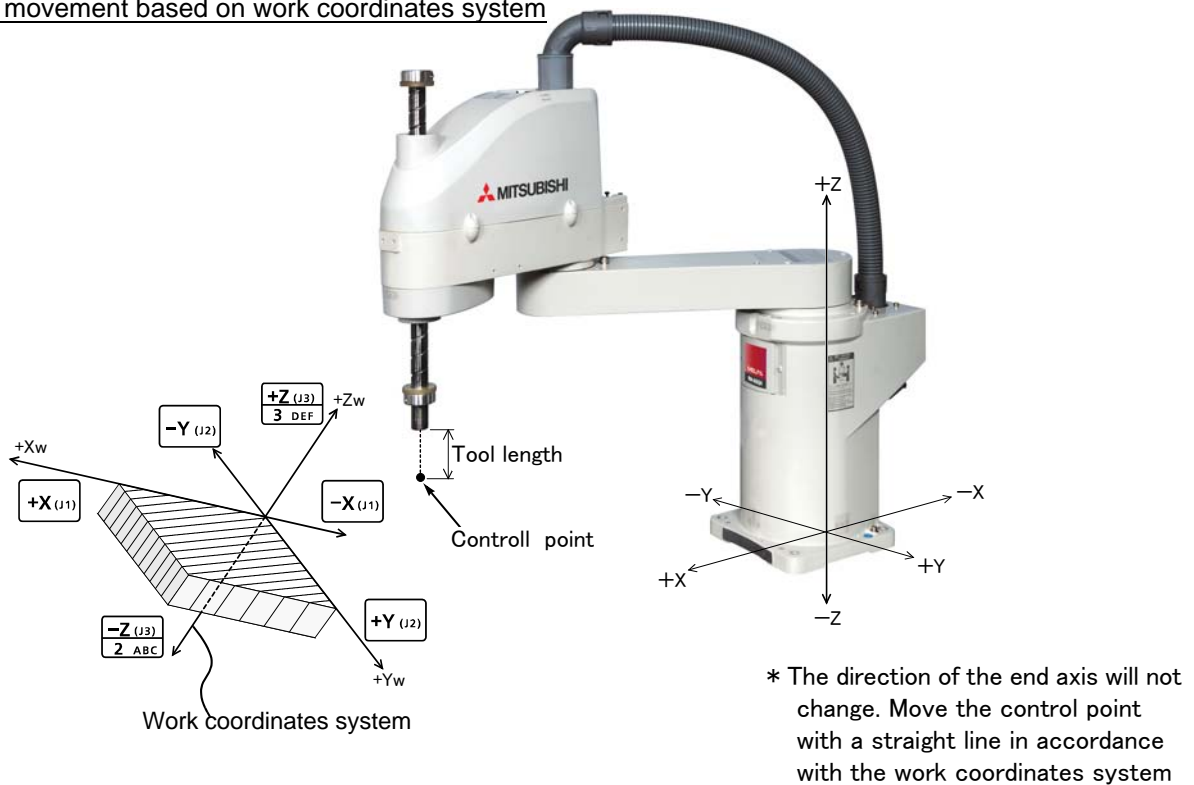

- When the $[+X (J1)]$ keys are pressed, the robot will move along the X axis plus direction on the work coordinates system.
When the $[-X (J1)]$ keys are pressed, Move along the minus direction.
- When the $[+Y (J2)]$ keys are pressed, the robot will move along the Y axis plus direction on the work coordinates system.
When the $[-Y (J2)]$ keys are pressed, Move along the minus direction.
- When the $[+Z (J3)]$ keys are pressed, the robot will move along the Z axis plus direction on the work coordinates system.
When the $[-Z (J3)]$ keys are pressed, Move along the minus direction.

Changing the end axis posture

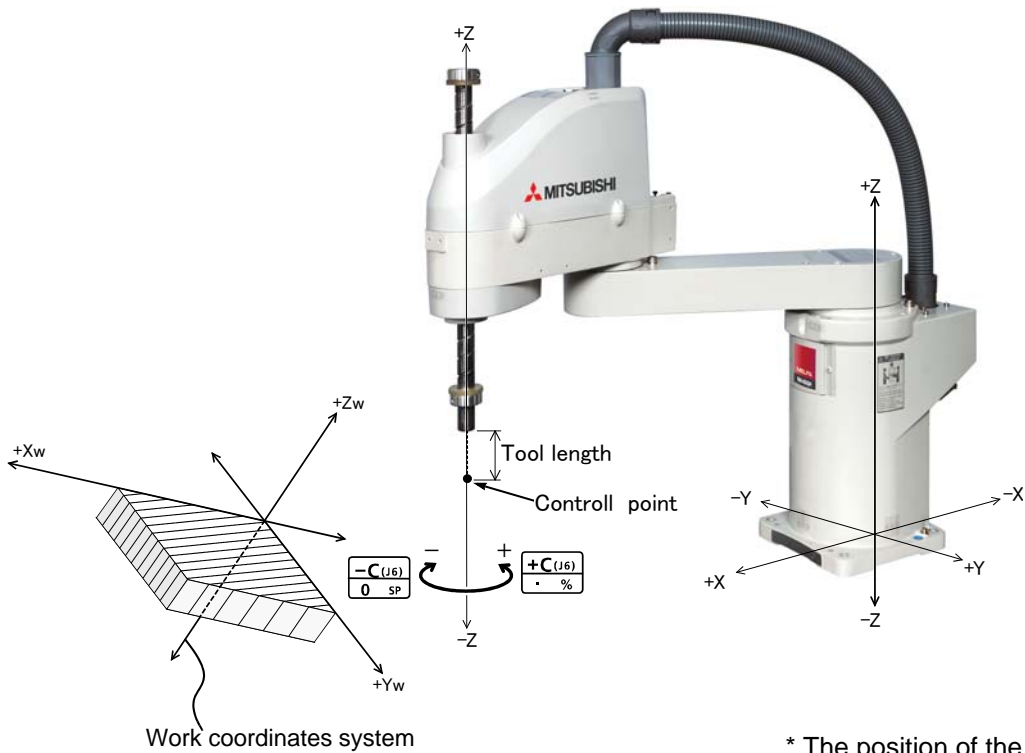

* The position of the control point does not change. The end axis is rotated.

- When the [+C (J6)] keys are pressed, The Z axis will rotate in the plus direction of the XYZ coordinate system. When the [-C (J6)] keys are pressed, Rotate in the minus direction.

◆◆◆ When the robot is in the transportation posture ◆◆◆
 There are directions from which linear movement is not possible from the transportation posture. In this case, the robot will not move. Refer to section "(1) JOINT jog operation" on page 31", and move the robot to a position where linear movement is possible, and then carry out XYZ jog.

◆◆◆ If the buzzer of T/B sounds and the robot does not move ◆◆◆
 If it is going to move the robot across the operation range, the buzzer of T/B sounds and the robot does not move. In this case, please move to the counter direction.

◆◆◆ Tool length ◆◆◆
 The default tool length is 0mm, and the control point is the center of the end axis. After installing the hand, set the correct tool length in the parameters. Refer to the separate manual "Detailed Explanation of Functions and Operations" for details.

3 Installing the option devices

The installation of the solenoid valve set, the hand input cable, the hand output cable and retrieval of the spare wiring require removal of the same cover. Therefore, it is better to install them simultaneously.

3.1 Installing the solenoid valve set (1S-VD04M(E)-03, 1S-VD04M(E)-04)

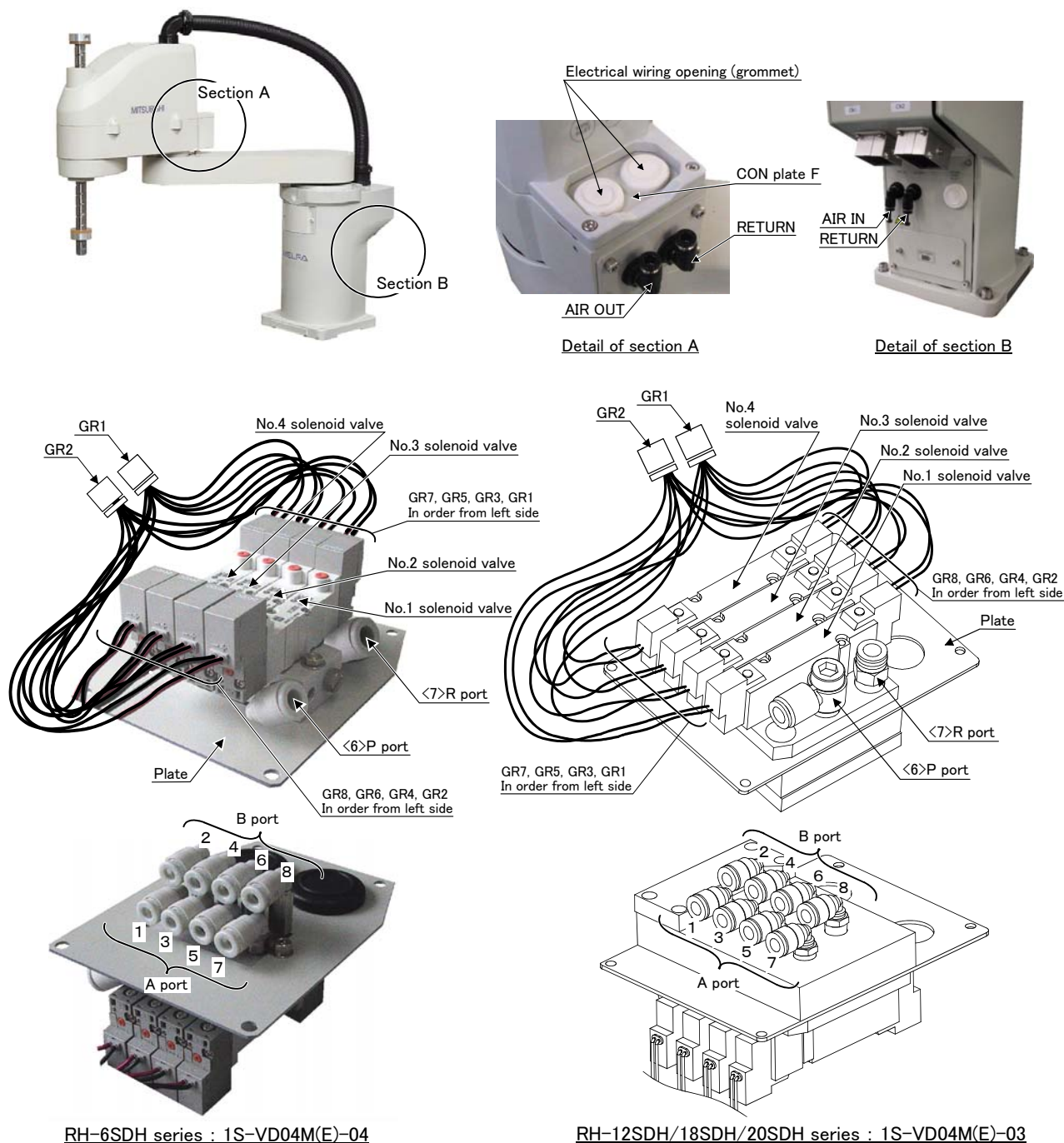
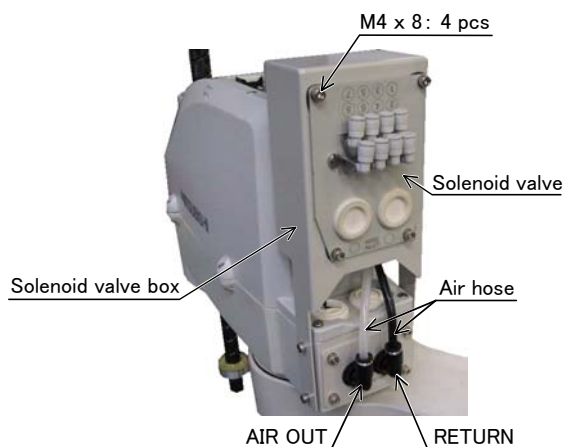
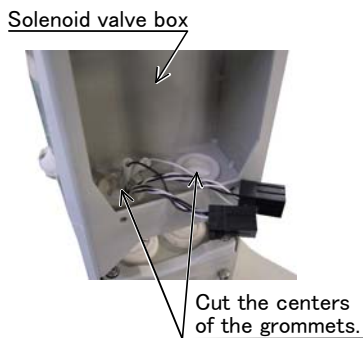
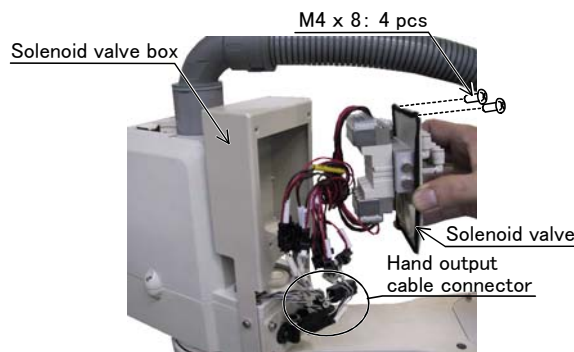
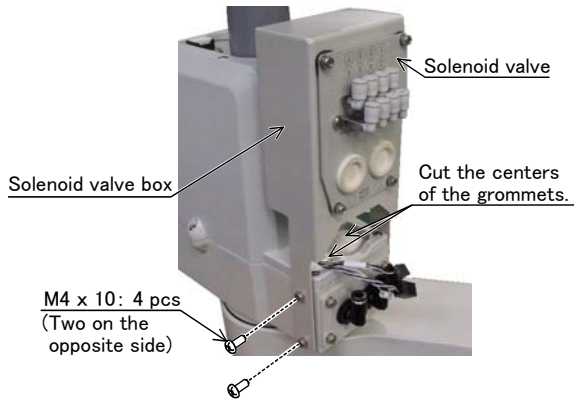

Fig.3-1 : Solenoid valve installation procedures

Fig. 3-1 shows the solenoid valve installation procedures and the solenoid valve connector connection procedures. The installation procedures are as follow. This work must be carried out with the controller power turned OFF. If the hand input cables (1S-HC35C-02) or the hand output cables (1S-GR35S-02) are used, be sure to install them in advance. (Refer to "3.2Installing the hand input cable" on page 50 and "3.3Installing the hand output cable" on page 51.)

Please note that neither the hand input cables nor the hand output cables can be installed once the solenoid valve set is installed.



- 1) Using a cutter knife, cut the centers of the grommets that come with the robot arm. Install the grommets through the connectors coming out of the rear of the No. 2 arm.
 - 2) Using the screw holes on the rear of the No. 2 arm, firmly install the solenoid valve box with the mounting screws (M4 x 10: 4 pcs) that come with the product. Be sure to securely tighten the screws so that they do not interfere with the robot arm.
 - 3) Loosen the mounting screws (M4 x 8: 4 pcs) of the solenoid valve from the solenoid valve box, and remove the solenoid valve.
 - 4) Using a cutter knife, cut the centers of the grommets located on the bottom of the solenoid valve box. Feed the connectors (GR1 and GR2) coming out of the rear of the No. 2 arm through the grommets, and connect them with the hand output cable connectors (GR1 and GR2) coming out of the solenoid valve.
 - 5) Pull out the air hose ($\phi 6$, provided by the customer) coming out of the port P of the solenoid valve from a grommet located on the bottom of the solenoid valve box. If air ventilation is required to satisfy the clean specification, connect an air hose ($\phi 6$, provided by the customer) to the port R of the solenoid valve, and pull it out from a grommet in the same manner.
 - 6) Install the solenoid valve back in the original position, and securely tighten it with its screws. Be careful not to pinch cables while in this installation operation. Also, be sure that no gap is created between the solenoid valve box and the solenoid valve by the sponge sealant applied onto the solenoid valve. If there is a gap, the protection specification may degrade.
- * In the case of the oil mist or clean specification, fill the surrounding areas of the grommets as well as the outlets of the cables and air hoses with silicon rubber.
- 7) Connect the air hose (port P) pulled out of the solenoid valve box to the coupling (AIR OUT) on the robot arm side. Also, if the port R of the solenoid valve is used, connect that air hose to the coupling (RETURN) on the robot arm side. In this case, remove the dustproof cap attached to the RETURN air coupling ($\phi 6$) in the rear of the robot's base section. If the robot is operated with this cap on, the exhaust air pressure increases and the solenoid valve may not function normally. Additionally, the exhaust air from the solenoid valve can be relieved to the designated location by connecting an exhaust hose to the RETURN air coupling ($\phi 6$, provided by the customer).

8) Connect the air hose on the primary air-supply side ($\phi 6$, provided by the customer) to AIR IN of the rear section of robot arm's base unit.

The connection correspondence after installation is as shown in [Table 3-1](#).

Table 3-1 : Solenoid valve ports and hoses: Correspondence of couplings and hand ports

Hand	Hand port	Solenoid valve port	Solenoid valve used
Hand 1	OPEN	1	1 st row
	CLOSE	2	
Hand 2	OPEN	3	2 nd row
	CLOSE	4	
Hand 3	OPEN	5	3 rd row
	CLOSE	6	
Hand 4	OPEN	7	4 th row
	CLOSE	8	

3.2 Installing the hand input cable

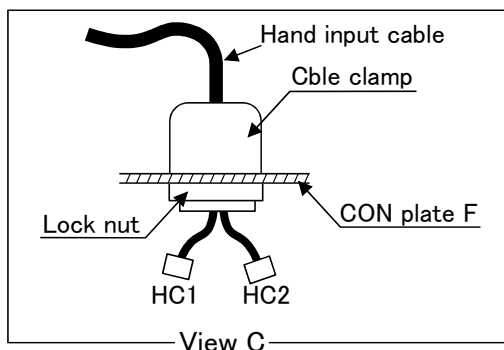
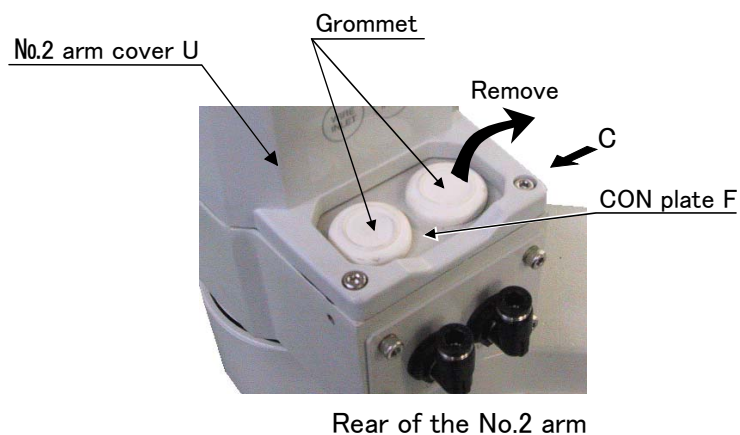

Fig.3-2 : Installing the hand input cable

- 1) Remove the hexagon socket bolts (ten M4 x 10: 10 pcs (RH-6SDH series), M4 x 10: 11 pcs (RH-12SDH/18SDH/20SDH series)) that hold the No. 2 arm cover U, and then remove both the No. 2 arm cover U.
- 2) Remove the bolts (M4 x 10: 2 pcs) fastening the CON plate F at the rear of the No. 2 arm, and remove the CON plate F.
- 3) Remove one of the two grommets of the CON plate F. After removing the grommet, peel off the sealant left on the hole section on of the CON plate F.
- 4) After removing the lock nut attached to the hand input cable, feed the connector side of the hand input cable (with a cable clamp) through the hole on the CON plate F. Replace the removed lock nut in position and fasten it securely.
- 5) Connect the connectors of "HC1" and "HC2" stored in section A shown in Fig. 3-1 to "HC1" and "HC2" of the hand input cable.
- 6) Install the CON plate F to the rear of the No. 2 arm., and be careful not to entangle the cables when you do so.
- 7) When you have completed the installation, reinstall the No.2 arm cover U to its original position. When installing, be careful not to damage the sponge sealant applied.

3.3 Installing the hand output cable

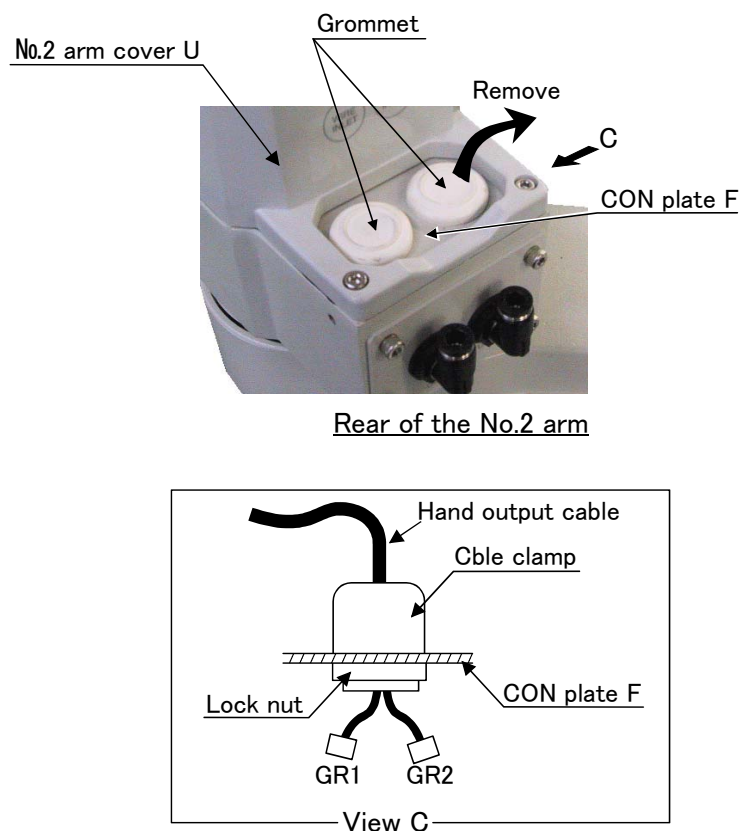

Fig.3-3 : Installing the hand output cable

- 1) Remove the hexagon socket bolts (ten M4 x 10: 10 pcs (RH-6SDH series), M4 x 10: 11 pcs (RH-12SDH/18SDH/20SDH series)) that hold the No. 2 arm cover U, and then remove both the No. 2 arm cover U.
- 2) Remove the bolts (M4 x 10: 2 pcs) fastening the CON plate F at the rear of the No. 2 arm, and remove the CON plate F.
- 3) Remove one of the two grommets of the CON plate F. After removing the grommet, peel off the sealant left on the hole section on of the CON plate F.
- 4) After removing the lock nut attached to the hand output cable, feed the connector side of the hand output cable (with a cable clamp) through the hole on the CON plate F. Replace the removed lock nut in position and fasten it securely.
- 5) Connect the connectors of "GR1" and "GR2" stored in section A shown in Fig. 3-1 to "GR1" and "GR2" of the hand output cable.
- 6) Install the CON plate F to the rear of the No. 2 arm., and be careful not to entangle the cables when you do so.
- 7) When you have completed the installation, reinstall the No.2 arm cover U to its original position. When installing, be careful not to damage the sponge sealant applied.

3.4 Changing the operating range

3.4.1 J1 and J2 axis

The operating ranges of both the J1, J2 and J3 axes can be limited. Change the mechanical stopper and the operating range to be set inside of that area.

If the operating range must be limited for example, to avoid interference with peripheral devices or to ensure safety—set up the operating range as shown below.

(1) Operating range changeable angle

The operating range must be set up at angels indicated by [Table 3-2](#).

Table 3-2 : Operating range changeable angle

Axis	Type	Direction	Standard	Changeable angle						
RH-6SDH series										
J1	RH-6SDH35*/45*/55*	+ side	+127 deg.	+90 deg.	+60 deg.	+30 deg.	0 deg.	Any one point shown at the left		
		Mechanical stopper angle	+130 deg.	+95 deg.	+65 deg.	+35 deg.	+5 deg.			
		Mechanical stopper position	P11	P12	P13	P14	P15			
		J2	RH-6SDH35*	+ side	+137 deg.	+117 deg.	+97 deg.	—	—	Any one point shown at the left
				Mechanical stopper angle	+139 deg.	+119 deg.	+99 deg.	—	—	
				Mechanical stopper position	P21	P22	P23	—	—	
J1	RH-6SDH45*/55*			+ side	+145 deg.	+125 deg.	+105 deg.	—	—	Any one point shown at the left
				Mechanical stopper angle	+147 deg.	+127 deg.	+107 deg.	—	—	
				Mechanical stopper position	P21	P22	P23	—	—	
		J2	RH-6SDH45*/55*	+ side	+145 deg.	+125 deg.	+105 deg.	—	—	Any one point shown at the left
				Mechanical stopper angle	+147 deg.	+127 deg.	+107 deg.	—	—	
				Mechanical stopper position	N21	N22	N23	—	—	
J3	Standard specifications			+ side	+297	Change is impossible.				
				- side	+97	+115 to+ 257mm				
	Clean, oil-mist specifications			+ side	+267	Change is impossible.				
		- side	+97	+115 to+ 227mm						
RH-12SDH/18SDH/20SDH series										
J1	RH-12SDH55*/70*/85* RH-18SDH85*/ RH-20SDH*	+ side	+140 deg.	+105 deg.	+75 deg.	+45 deg.	+15 deg.	Any one point shown at the left		
		Mechanical stopper angle	+143 deg.	+110 deg.	+80 deg.	+50 deg.	+20 deg.			
		Mechanical stopper position	P11	P12	P13	P14	P15			
		J2	RH-12SDH55*/70*	+ side	+145 deg.	+125 deg.	—	—	—	Any one point shown at the left
				Mechanical stopper angle	+150 deg.	+130 deg.	—	—	—	
				Mechanical stopper position	P21	P22	—	—	—	
J1	RH-12SDH85* RH-18SDH85* RH-20SDH*			+ side	+153 deg.	+125 deg.	—	—	—	Any one point shown at the left
				Mechanical stopper angle	+155 deg.	+130 deg.	—	—	—	
				Mechanical stopper position	P21	P22	—	—	—	
		J2	RH-12SDH85* RH-18SDH85* RH-20SDH*	+ side	+153 deg.	+125 deg.	—	—	—	Any one point shown at the left
				Mechanical stopper angle	+155 deg.	+130 deg.	—	—	—	
				Mechanical stopper position	N21	N22	—	—	—	

Note1) The * symbols next to the robot types indicate the up/down stroke length, environment specification, specification with controller protection box (RH-6SDH series) or controller specification with countermeasure against oil mist (RH-12SDH/18SDH/20SDH series). In this case, it is possible to change the movement ranges shown in [Table 3-2](#) for any model.

Note2) The changeable angle shown in [Table 3-2](#) indicates the operation range by the software.

The mechanical stopper angle in the table shows the limit angle by the mechanical stopper. Use caution when laying out the robot during the designing stage.

Note3) The changeable angle can be set independently on the + side and - side.

Note4) Refer to [Fig. 3-4](#) and [Fig. 3-5](#) for mechanical stopper position. The J3 axis makes the mechanical stopper slide.

(2) Installing the mechanical stopper

1) Turn the controller power OFF.

2) Refer to [Table 3-2](#) and [Fig. 3-4](#) and [Fig. 3-5](#), install the hexagonal socket head bolts in the screw holes corresponding to the angles to be set. [Fig. 3-4](#) shows the mechanical stopper position and bolt size of the J1 axis, and [Fig. 3-5](#) shows those of the J2 axis. If the screw holes are hidden behind the arms, slowly move the No. 1 and No. 2 arms.

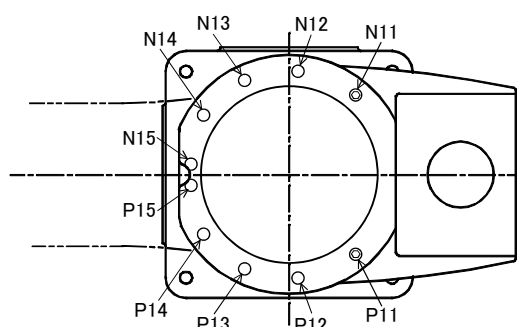

*Hexagon socket bolt = M8 x 16

For RH-6SDH series

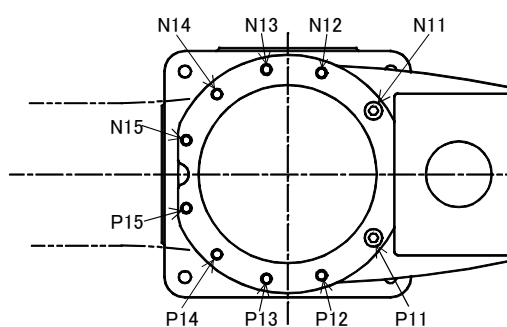

*Hexagon socket bolt = M12 x 25

For RH-12SDH/18SDH/20SDH series

Fig.3-4 : Mechanical stopper position (J1 axis)

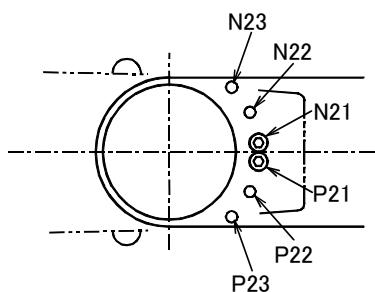

*Hexagon socket bolt = M8 x 16

For RH-6SDH35*

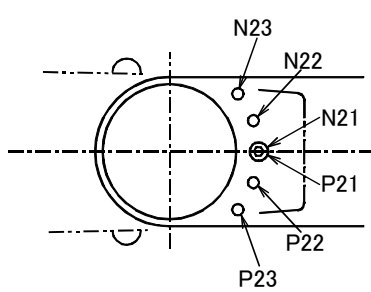

*Hexagon socket bolt = M8 x 16

For RH-6SDH45*/55*

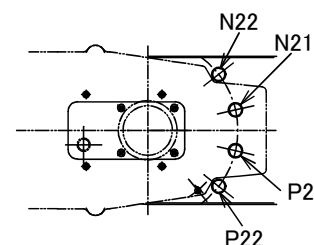

*Hexagon socket bolt = M8 x 16

For RH-12SDH/18SDH/20SDH

Fig.3-5 : Mechanical stopper position (J2 axis)

(3) Setting the operation range parameter

Set up the operation range (Changeable angle in [Table 3-2](#)) to the Joint movement range parameter MEJAR.

1) Turn the controller power ON.

2) Set up the changed operation range to the Joint movement range parameter.

MEJAR: (J1 minus side movement range, J1 plus side movement range, J2 minus side movement range, J2 plus side movement range,)

(4) Setting the mechanical stopper origin parameter

If the movement range of either the minus (-) side of the J1 axis or the plus (+) side of the J2 axis has been changed, change the mechanical stopper origin parameter MORG.

1) Change the parameter MORG to the angle of the mechanical stopper position that has been set.

MORG: (J1 side mechanical stopper position, J2 side mechanical stopper position,)

(5) Confirming the operation range

When completed changing the parameters, turn the controller power OFF and ON. Move the changed axis to the operation range limit with joint jog operation, and confirm that the limit over occurs and the robot stops at the angle changed for both the +/- side.

This completes the changing the operating range.

4 Basic operations

The basic operations from creating the program to automatic operation are explained in section "4. Basic operations" in the "From Controller Setup to Maintenance" manual. Refer that manual as necessary.

5 Maintenance and Inspection

The maintenance and inspection procedures to be carried out to use the robot for a long time without trouble are described in this chapter. The types and replacement methods of consumable parts are also explained.

5.1 Maintenance and inspection interval

Maintenance and inspection are divided into the inspections carried out daily, and the periodic inspections carry out at set intervals. Always carry these out to prevent unforeseen trouble, to maintain the product for a long time, and to secure safety.

(1) Inspection schedule

In addition to the monthly inspection, add the following inspection items every three months (estimated at 500 Hr operation hours).

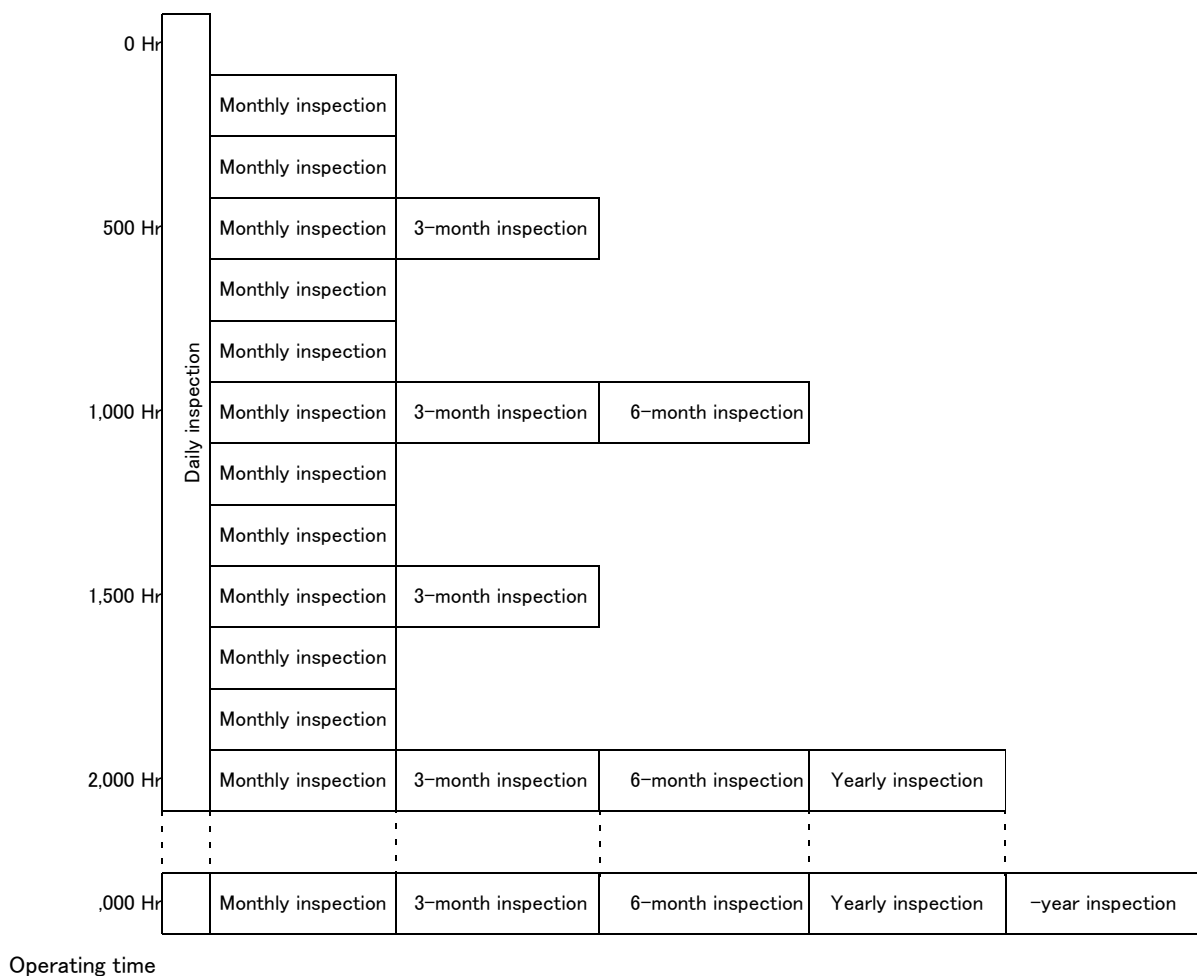

<Guideline for inspection period>

For one shift

$$8 \text{ Hr/day} \times 20 \text{ days/month} \times 3 \text{ months} = \text{approx. } 500 \text{ Hr}$$

$$10 \text{ Hr/day} \times 20 \text{ days/month} \times 3 \text{ months} = \text{approx. } 600 \text{ Hr}$$

For two shifts

$$15 \text{ Hr/day} \times 20 \text{ days/month} \times 3 \text{ months} = \text{approx. } 1000 \text{ Hr}$$

[Caution] When using two lines, the 3-month inspection, 6-month inspection and yearly inspection must be carried out when half the time has passed.

Fig.5-1 : Inspection schedule

5.2 Inspection items

The inspection items for the robot arm are shown below.

Also refer to section "5. Maintenance and inspection" in the "Controller setup, basic operation, and maintenance" manual, and inspect the controller.

5.2.1 Daily inspection items

Carry out the daily inspections with the procedures given in [Table 5-1](#).

Table 5-1 : Daily inspection items (details)

Procedure	Inspection item (details)	Remedies
Before turning power ON (Check the following items before turning the power ON.)		
1	Are any of the robot installation bolts loose? (Visual)	Securely tighten the bolts.
2	Are any of the cover tightening screws loose? (Visual)	Securely tighten the screws.
3	Are any of the hand installation bolts loose? (Visual)	Securely tighten the bolts
4	Is the power supply cable securely connected? (Visual)	Securely connect.
5	Is the machine cable between the robot and controller securely connected? (Visual)	Securely connect.
6	Are there any cracks, foreign contamination or obstacles on the robot and controller cover?	Replace with a new part, or take remedial measures.
7	Is any grease leaking from the robot arm? (Visual)	After cleaning, replenish the grease.
8	Is there any abnormality in the pneumatic system? Are there any air leaks, drain clogging or hose damage? Is the air source normal? (Visual)	Drain the drainage, and remedy the air leaks (replace the part).
After turning the power ON (Turn the power ON while monitoring the robot.)		
1	Is there any abnormal motion or abnormal noise when the power is turned ON?	Follow the troubleshooting section.
During operation (try running with an original program)		
1	Check whether the movement points are deviated? Check the following points if there is any deviation. 1. Are any installation bolts loose? 2. Are any hand installation section bolts loose? 3. Are the positions of the jigs other than the robot deviated? 4. If the positional deviation cannot be corrected, refer to "Troubleshooting", check and remedy.	Follow the troubleshooting section.
2	Is there any abnormal motion or abnormal noise? (Visual)	Follow the troubleshooting section.

5.2.2 Periodic inspection

Carry out periodic inspection with the procedures given in [Table 5-2](#).

Table 5-2 : Periodic inspection items (details)

Procedure	Inspection item (details)	Remedies
Monthly inspection items		
1	Are any of the bolts or screws on the robot arm loose?	Securely tighten the bolts.
2	Are any of the connector fixing screws or terminal block terminal screws loose?	Securely tighten the screws.
3	Remove the cover at each section, and check the cables for wear damage and adherence of foreign matter.	Check and eliminate the cause. If the cables are severely damaged, contact the Mitsubishi Service Department.
3-month inspection items		
1	Is the timing belt tension abnormal?	If the timing belt is loose or too tense, adjust it.
6-month inspection items		
1	Is the friction at the timing belt teeth severe?	If the teeth are missing or severe friction is found, replace the timing belt.
Yearly inspection items		
1	Replace the backup battery in the robot arm.	Exchange it referring to “5.3.7 Replacing the backup battery” on page 77.

5.3 Maintenance and inspection procedures

The procedures for carrying out the periodic maintenance and inspection are described in this section. Thoroughly read the contents, and follow the instructions. This work can be commissioned to the Mitsubishi Service Department for a fee. (Never disassemble, etc., the parts not described in this manual.)

The maintenance parts, etc., required for the customer to carry out maintenance and inspection are described in "5.5 Maintenance parts" on page 80 of this manual. Always contact your dealer when parts are needed.

CAUTION The origin of the machine system could deviate when this work is carried out. "Review of the position data" and "re-teaching" will be required.

5.3.1 Robot arm structure

An outline structure drawing is shown in Fig. 5-2. Each part is as shown below.

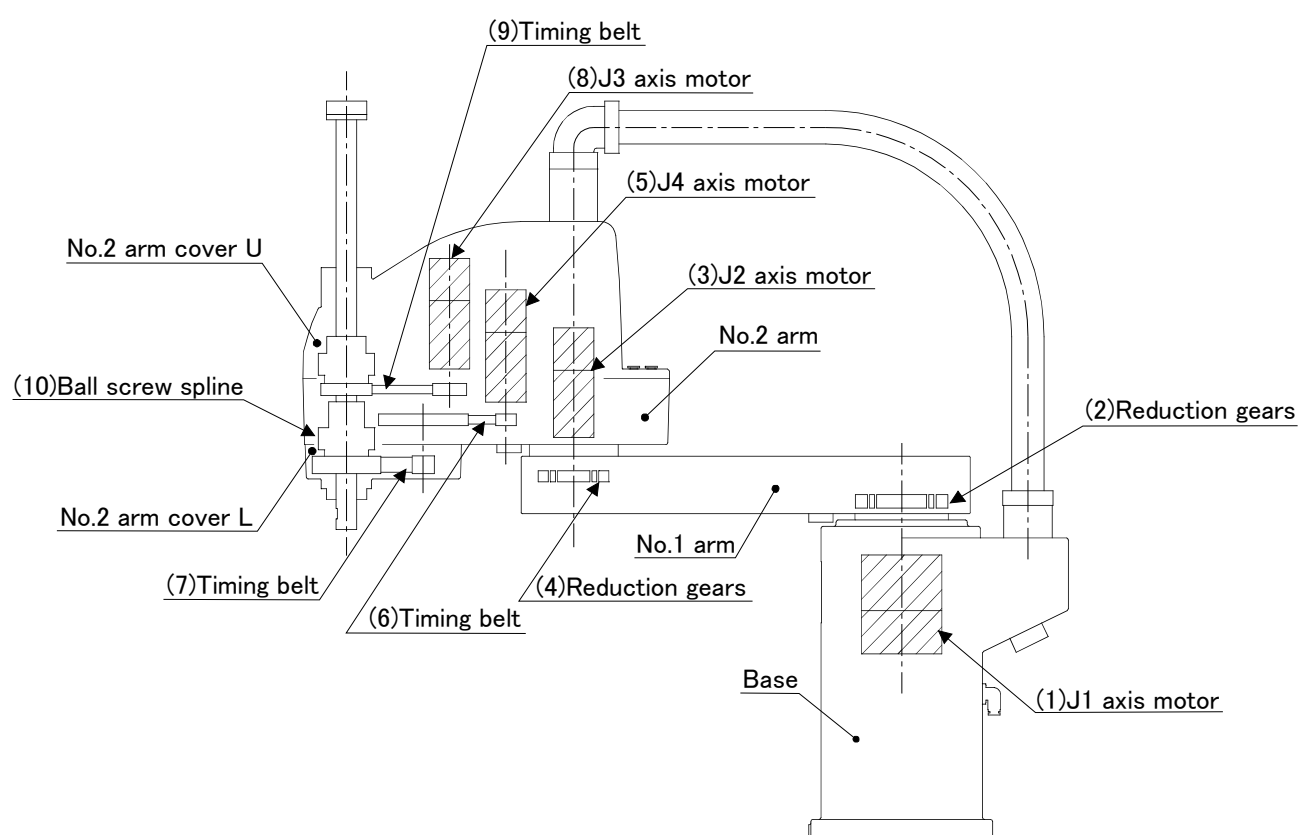

Fig.5-2 : Outline structure drawing of robot arm

5.3.2 Installing/removing the cover

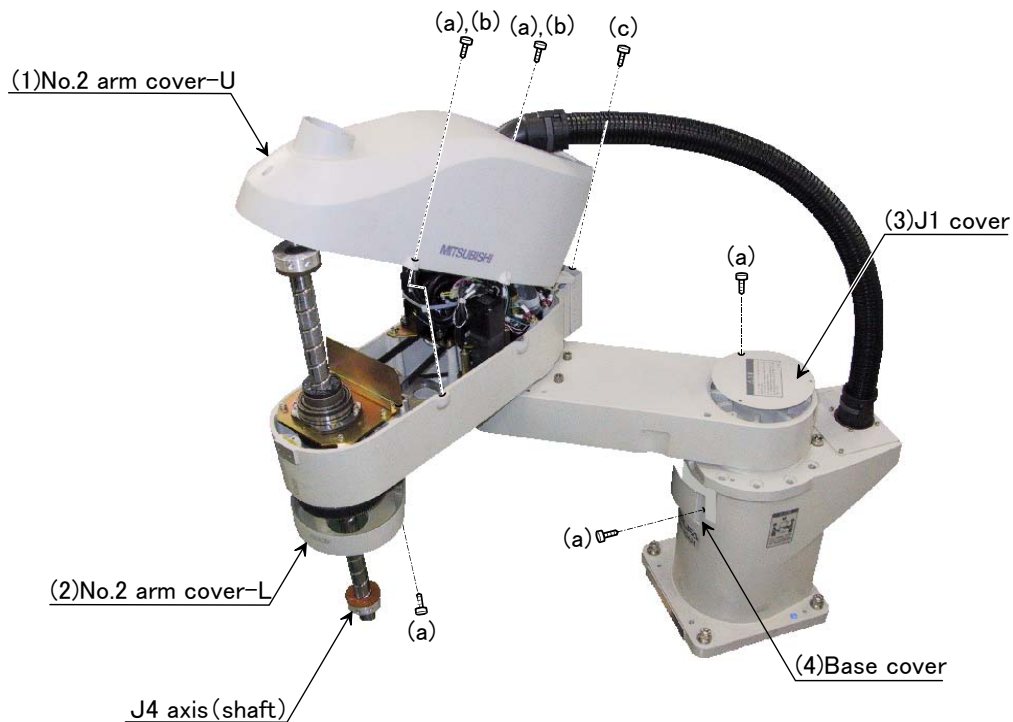

Fig.5-3 : Installing/removing the cover

Table 5-3 : Cover and Packing names

No.	Cover names	Qty.	Packing		Fixing torque (N · m)
			Names	Sticking side	
RH-6SDH standard specification					
(1)	No.2 arm cover-U	1	PackingC	Cover side	1.39 ~ 1.89
(3)	J1 cover	1	PackingC	Robot arm side	1.39 ~ 1.89
RH-6SDH clean or oil mist specification					
(1)	No.2 arm cover-U	1	PackingA	Cover side	1.39 ~ 1.89
(2)	No.2 arm cover-L	1	PackingA	Cover side	1.39 ~ 1.89
(3)	J1 cover	1	PackingA	Robot arm side	1.39 ~ 1.89
(4)	Base cover	1	PackingB	Robot arm side	1.39 ~ 1.89
RH-12SDH /18SDH/20SDH standard specification					
(1)	No.2 arm cover-U	1	PackingC	Cover side	1.39 ~ 1.89
(3)	J1 cover	1	PackingC	Robot arm side	1.39 ~ 1.89
RH-12SDH /18SDH/20SDH clean or oil mist specification					
(1)	No.2 arm cover-U	1	PackingA	Cover side	1.39 ~ 1.89
(2)	No.2 arm cover-L	1	PackingA	Cover side	1.39 ~ 1.89
(3)	J1 cover	1	PackingA	Robot arm side	1.39 ~ 1.89
(4)	Base cover	1	PackingB	Robot arm side	1.39 ~ 1.89

Note) This robot has packing. Refer to "Table 5-7 : Consumable part list" on page 80 for type name of packing.

Table 5-4 : Cover installation screw list

No.	Cover name	Installation screw name: Qty.	Remarks
(1)	No.2 arm cover-U	(a)Hexagon socket bolts, M4 x 10: 10 (b)Hexagon socket bolts, M4 x 10: 9 (c)Hexagon socket bolts, M4 x 14: 2	RH-6SDH series RH-12SDH/18SDH/20SDH series RH-12SDH/18SDH/20SDH series (They are two places at back.)
(2)	No.2 arm cover-L	(a)Hexagon socket bolts, M4 x 10: 3	
(3)	J1 cover	(a)Hexagon socket bolts, M4 x 10: 3	
(4)	Base cover	(a)Hexagon socket bolts, M4 x 10: 2	

- (1) Referring to [Fig. 5-3](#), remove the covers.
- (2) The names of the covers are given in [Table 5-3](#), and a list of the cover installation screws is given in [Table 5-4](#).
- (3) Lower the J4 axis (shaft) using jog operations before removing the No.2 arm cover-U.
- (4) When reattaching the covers after a maintenance inspection, proceed in the reverse order of their removal.

[Note] Sealant is applied to the cover joint surface of the oil mist specification and clean specification models. Be sure to replace the sealant if it has been dislocated and bent or crushed and does not return to its original shape. (Use liquid gasket and packing in "[Table 5-9 : Spare parts list](#)" on page 81.)

Moreover, in the case of oil mist specification and clean specification models, it is necessary to remove the top and bottom bellows. Refer to "[5.3.5 Replacing Bellows](#)" on page 72 for details on how to remove them.

5.3.3 Packing Replacement Procedure

The packing gets deteriorated with the passage of time and must be replaced as required. Table 5-5 provides guidelines for replacing the packing. Replace the packing in accordance with the instructions given below. If the packing is not replaced in a timely manner, water or oil will be allowed to intrude the robot, possibly making it inoperative.

Table 5-5 : Packing replacement guideline

Service environment	Whether or not robot is pressurized	When packing must be replaced
General environment	Not pressurized ^{Note1)}	When signs of cracking or peeling are noted in the packing.
Clean room	Not pressurized ^{Note1)}	
Oil mist	Pressurized	
	Not pressurized	When the cover mounted on the robot is removed/put back in place

Note1) When used in the "general" or "clean room" environment, robot can do away with pressurization.

(1) Packing Replacement Instructions

Stick again new packing as before.

- 1) Remove the old packing, and clean and degrease the surface on which it has been placed.
- 2) The sticking surface of packing is double-coated adhesive tape. Referring to "Fig.5-4 : Example of sticking packing (good example)" and "Fig.5-6 : Sticking the cord-like packing", and stick the packing in line with form . Be careful for the packing not to slide. The example of unsuitable packing slid is shown in "Fig.5-5 : Example of sticking packing (bad example)".
- 3) Some of the packing are to be stuck to the robot body; others, to the robot cover. The location of sticking the packing is shown in "Table 5-3 : Cover and Packing names"
- 4) Although the No.2 arm cover (U) sticks two or more packings per place, it has length with which packing ends overlap. Stick packing in the following procedures. For more information, see "Fig.5-7 : Examples of packing overlaps". Examples of improperly treated cut edge are shown, as well.
 - a) Stick packing in line with form of the sticking surface. Finally, cut packing so that adjoining pieces have a 1mm overlap at the end.
 - b) Apply liquid gasket to the cut edges. (Designated liquid gasket: 1212 (Maker: Three Bond))
 - c) Stick so that the gap may not be made to each other's packing.

 **CAUTION** Do not install the cover immediately after sticking packing. Install the cover, after the 6 hours pass after sticking packing for gasket hardening.

- 5) Confirm that packing is stuck correctly and install the cover. When tightening the bolts fixing the cover, avoid tightening them to a specified torque at a time. Tighten the bolt in the order shown as much as possible in the "Fig. 5-10: Example of order which tighten bolts." The torque which tightens the fixing bolt of each cover is shown in "Table 5-3 : Cover and Packing names".

 **CAUTION** Stick the packing securely, pressing down with the finger. If sticking is insufficient, when the cover is installed, packing slides by the pressure, and there is a possibility that it may become impossible to secure protection performance.

Completion of packing replacement

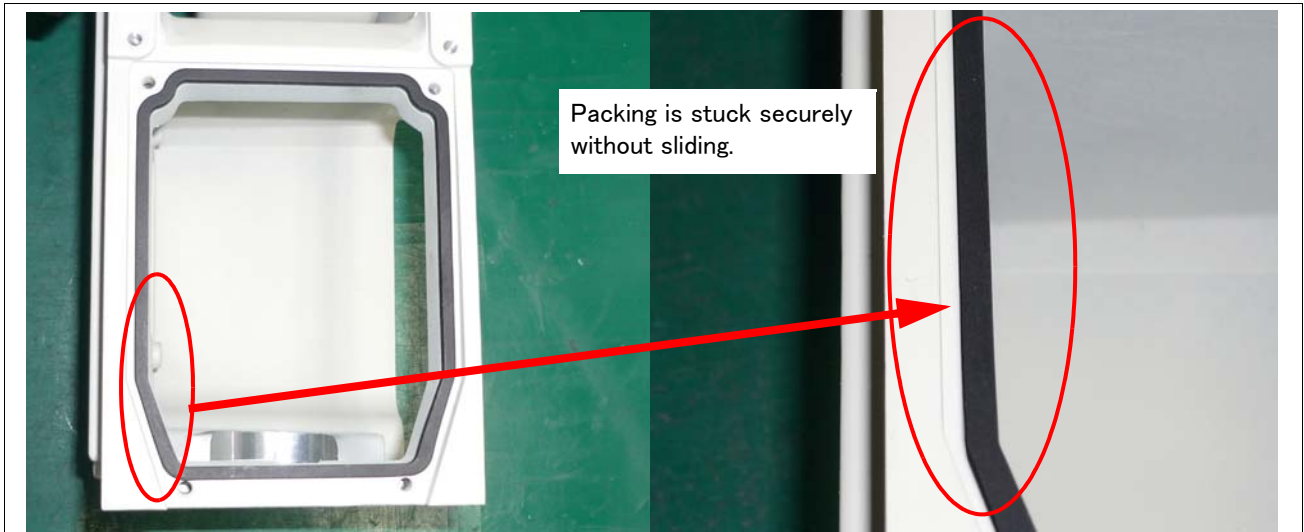

Fig.5-4 : Example of sticking packing (good example)

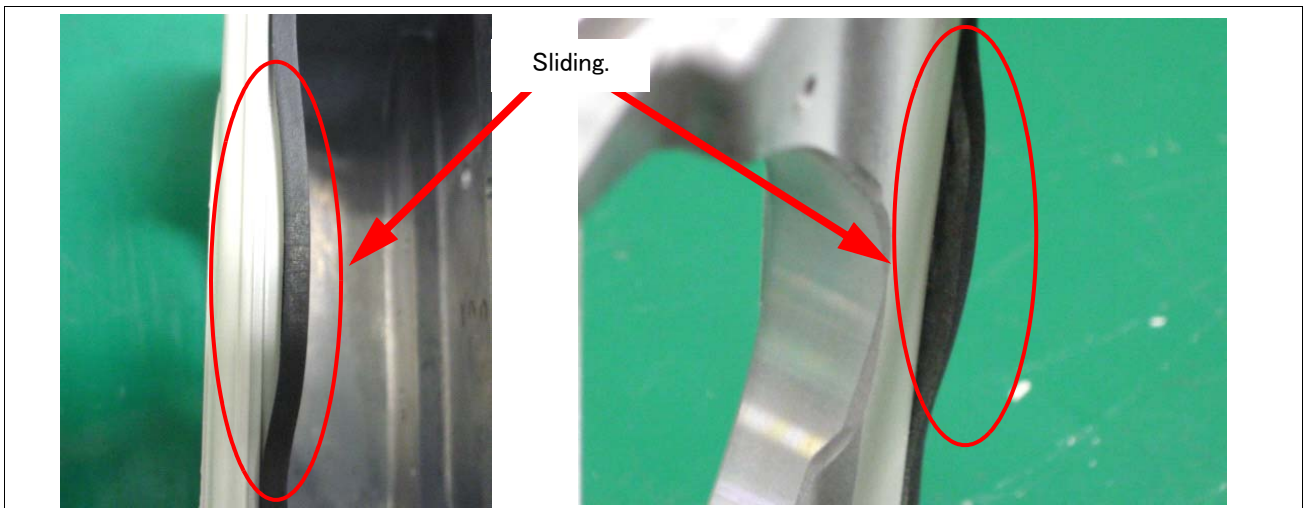

Fig.5-5 : Example of sticking packing (bad example)

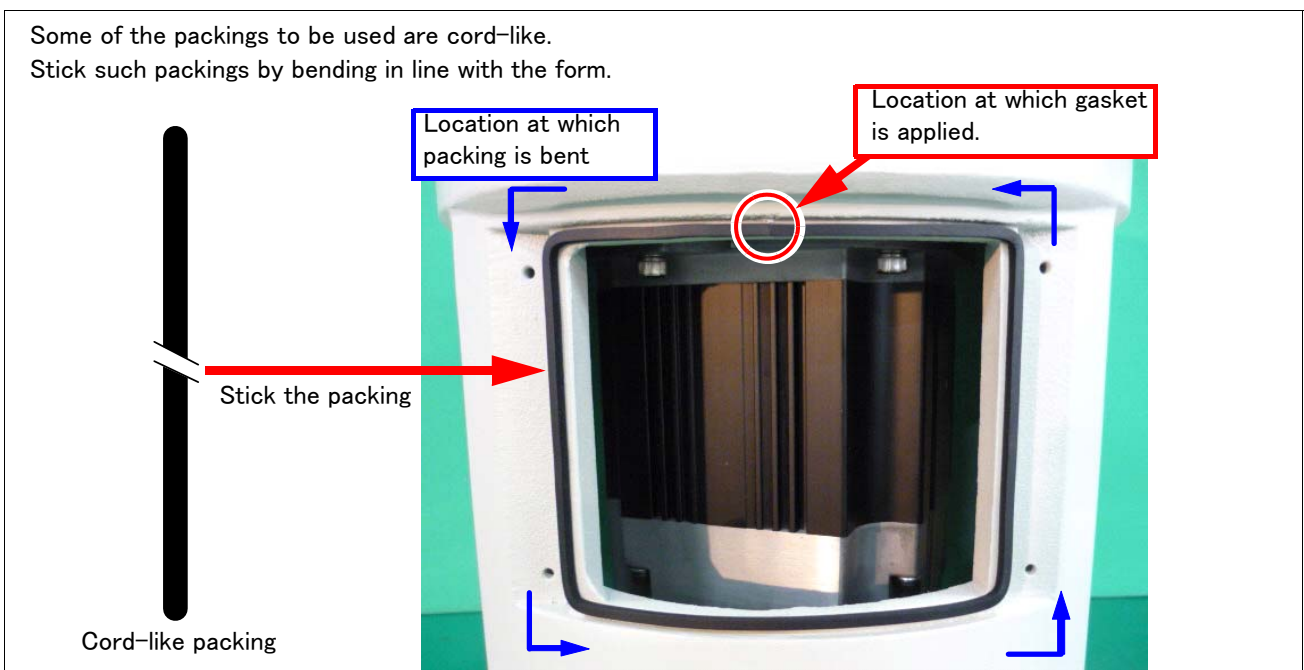
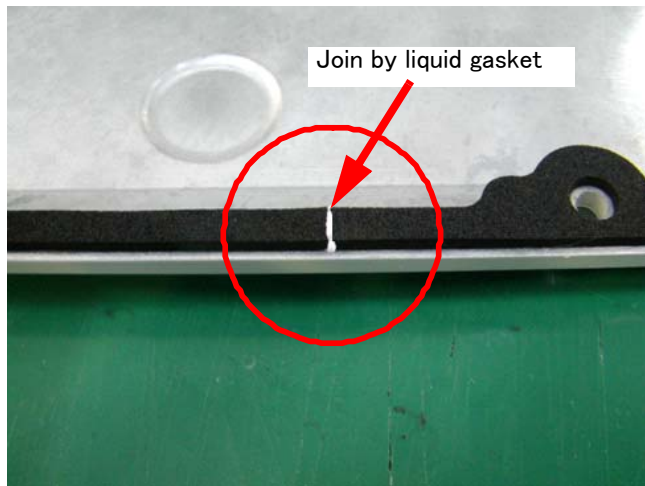

Fig.5-6 : Sticking the cord-like packing



[1] Cut the packing so that there is a 1mm overlap at the end.

[2] Apply liquid gasket to the cut edges.



[3] Stick the packing so that there is no gap between the adjacent pieces.

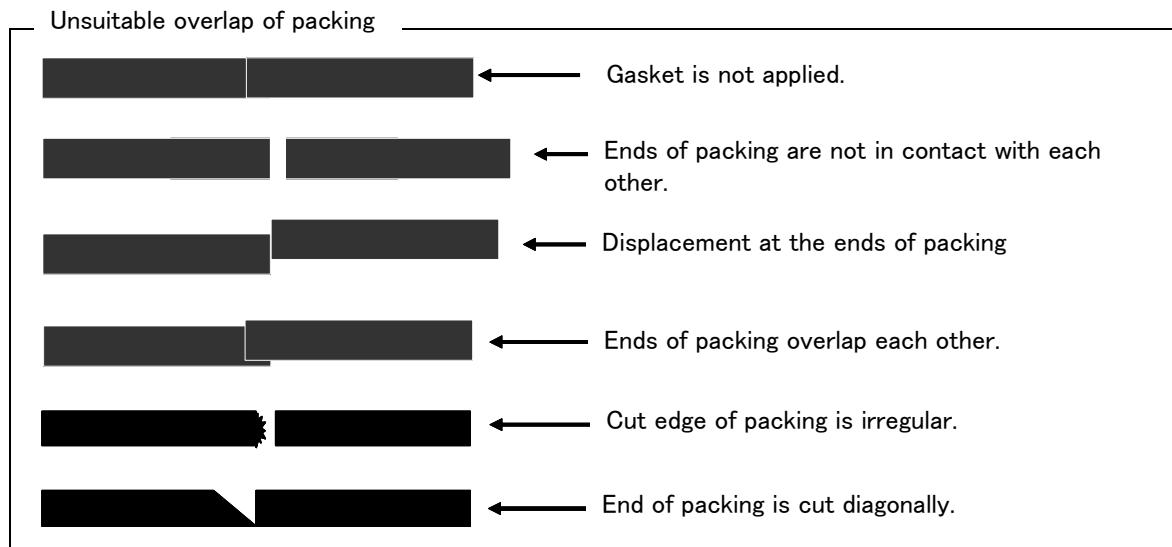

Fig.5-7 : Examples of packing overlaps

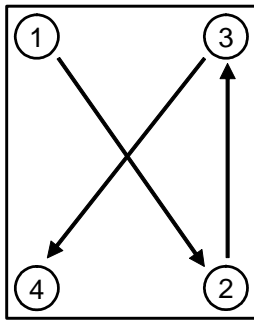

Fig.5-8 : Example of order which tighten bolts

5.3.4 Inspection, maintenance and replacement of timing belt

This robot uses a timing belt for the drive conveyance system of the J5 axis. Compared to gears and chains, the timing belt does not require lubrication and has a low noise. However, if the belt usage method and tension adjustment are inadequate, the life could drop and noise could be generated. Sufficient aging to remove the initial elongation of the belt, and adjustment of the belt tension have been carried out before shipment from the factory.

However, depending on the robot working conditions, elongation will occur gradually over a long time. The tension must be confirmed during the periodic inspection. The timing belt must be replaced in the following cases.

In addition, it is serviceable if there is the sound wave type belt tension gauge in inspection and adjustment of the timing belt. The recommendation gauge is shown below. Please prepare by customer. Refer to the “(4)Timing belt tension” on page 71 for the tension adjustment value of the timing belt.

Maker:Gates Unitta Asia Company,
Type:U-505

(1) Timing belt replacement period

The timing belt life is greatly affected by the robot working conditions, so a set time cannot be given. However, if the following symptoms occur, replace the belt.

- 1) When cracks form at the base or back of the belt teeth.
- 2) When the belt expands due to adherence of oil, etc.
- 3) When the belt teeth wear (to approx. half of the tooth width).
- 4) When the belt teeth jump due to belt teeth wear.
- 5) When the belt snaps.

CAUTION

Due to the manufacturing of the timing belt, initial wear will occur. Wear chips may accumulate in the cover after approx. 300 Hr of operating the robot, but this is not a fault. If the wear chips appear soon after wiping them off, replace the belt.

CAUTION

When the belt is replaced, the machine system origin may deviate. In this case, the position data must be reviewed.

(2) Inspection, maintenance and replacement of J3-axis timing belt

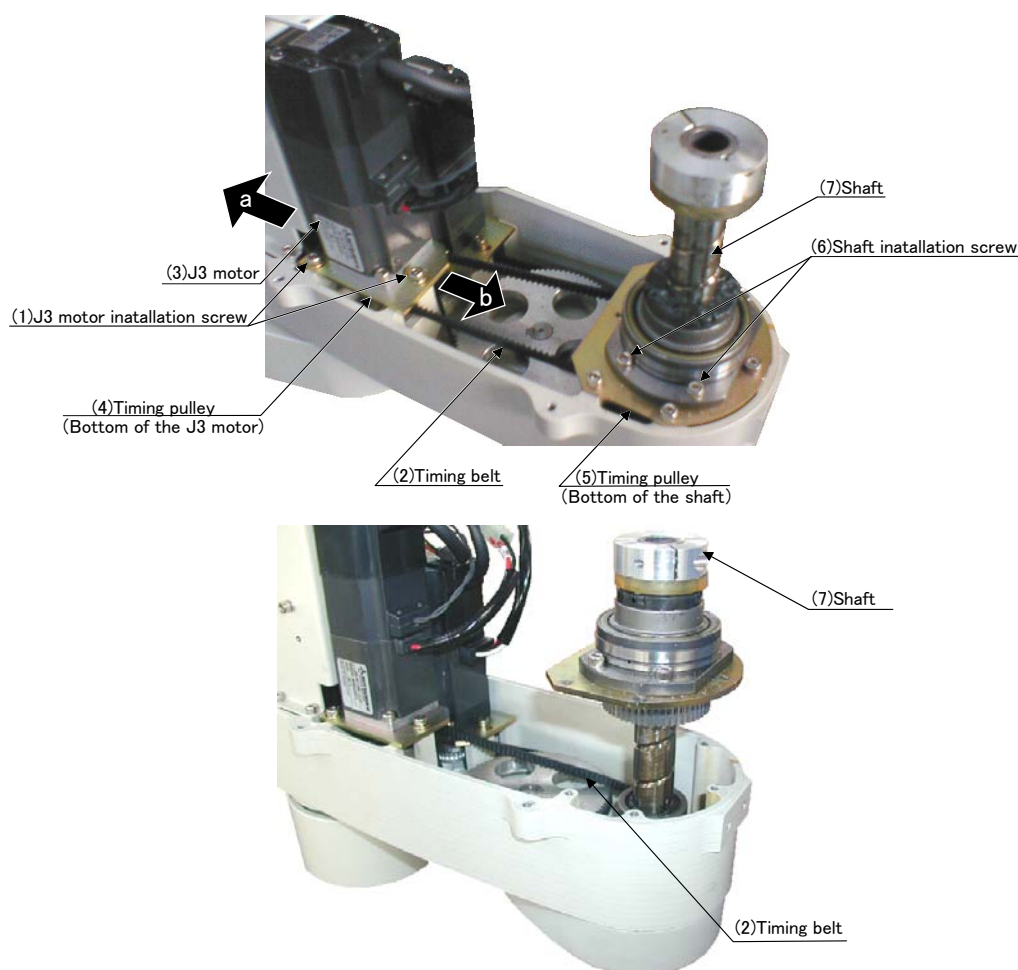

Fig.5-9 : Inspection, maintenance and replacement of J3-axis timing belt

■ Inspecting the J3 axis timing belt

- 1) Confirm that the robot controller power is OFF.
- 2) Refer to Fig. 5-3, and remove the No.2 arm cover-U.
- 3) Visually confirm that the symptoms indicated in “(1)Timing belt replacement period” have not occurred with the timing belt.
- 4) Check the belt tension as shown in “(4)Timing belt tension” on page 71. Lightly press the center of the belt, and confirm that the value of belt slack is in following.
 - RH-6SDH series: Force to press the belt: apprpx. 2N / Flexure: approx. 2.5mm
 - RH-12SDH/18SDH/20SDH: series.. Force to press the belt: apprpx. 4N / Flexure: approx. 3.7mm

■ Adjusting the J3 axis timing belt

- 1) Carry out steps 1) and 2) indicated in “ ■ Inspecting the J3 axis timing belt” above.
- 2) Lightly loosen J3 motor installation screws (1) (Be careful not to overly loosen the screws.).
- 3) While checking the tension of the timing belt (2), move the J3 motor (3) in the directions of the arrows indicated in the figure above. Lightly press the center of the belt, and confirm that the value of belt slack is in following.
 - RH-6SDH series: Force to press the belt : approx. 2N / Flexure: 2.5mm
 - RH-12SDH/18SDH/20SDH series: Force to press the belt: approx. 4N / Flexure: 3.7mm
- 4) The belt tension will increase when moved in the direction of arrow a, and will decrease when moved in the direction of arrow b.
- 5) If the belt is loosened too much when adjusting the tension causing it to come off the timing pulleys (4) and (5), or if the belt and pulley teeth engagement is deviated, the machine system’s origin will deviate.
- 6) After adjusting, securely tighten the J3 motor installation screws (1). Improper tightening can cause the belt to loosen with vibration.

■ Replacing the J3 axis timing belt

- 1) Fig. 5-9 shows the methods for inspecting, adjusting and replacing the timing belt.
- 2) Move the robot posture with the teaching pendant so that the J3 axis contacts the mechanical stopper of upside. The J3 axis brakes must be released.
- 3) Turn off the controller power.
- 4) Be careful not to let the timing pulley (4) on the J3 axis motor move while the belt is being changed.
- 5) If the pulley (4) and (5) position relation deviates, the position could deviate.
- 6) Loosen the J3 motor installation screws (1) to lift the J3 motor (3) upward and remove the timing belt (2) from the timing pulley (4).
- 7) Loosen the shaft installation screws (6) to lift the shaft upward and remove the timing belt (2) by lifting it from the bottom spline section. (Refer to Fig. 5-9.)
- 8) Install a new timing belt on the timing pulleys (4) and (5) in the reverse order of the procedure described in steps 6) and 7) above.
- 9) With the J3 axis touching the upper mechanical stopper, hook the timing belt (2) around the timing pulleys (4) and (5).
- 10) Perform tension adjustment referring to steps 3) to 6) in " ■ Adjusting the J3 axis timing belt" and "(4)Timing belt tension" on page 71.
 For more accurate tension adjustment, pull out the idler (4) with a force of 65N for RH-6SDH or 90N for RH-12SDH/18SDH/20SDH using the push-pull gauge, and then tighten the idler installation screws (3) as shown in Fig. 5-10. The use of the method as shown in Fig. 5-10 is recommended.
- 11) The position could deviate after the belt is replaced. Confirm that the position has not deviated.

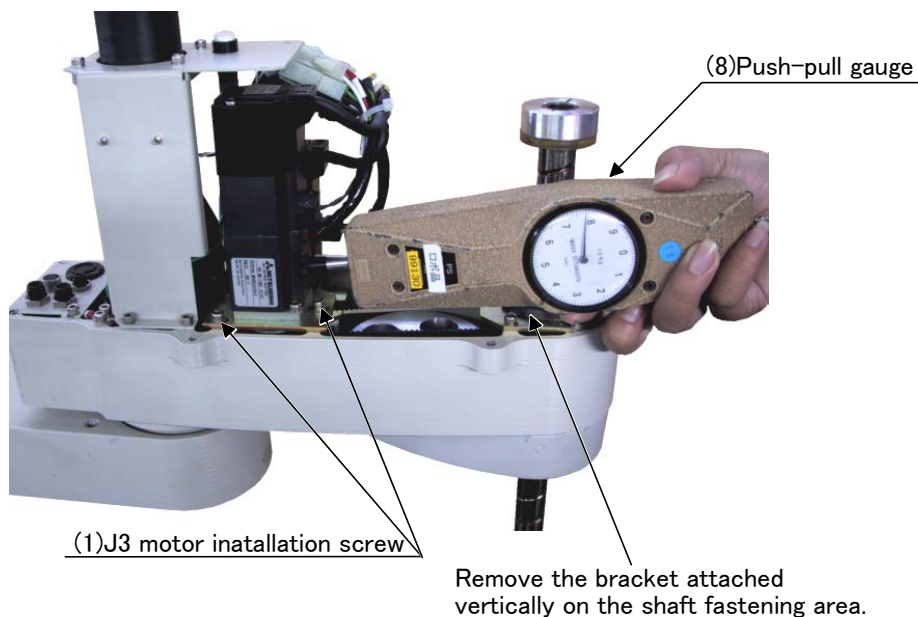

Fig.5-10 : J3 axis timing belt tension

(3) Inspection, maintenance and replacement of J4-axis timing belt

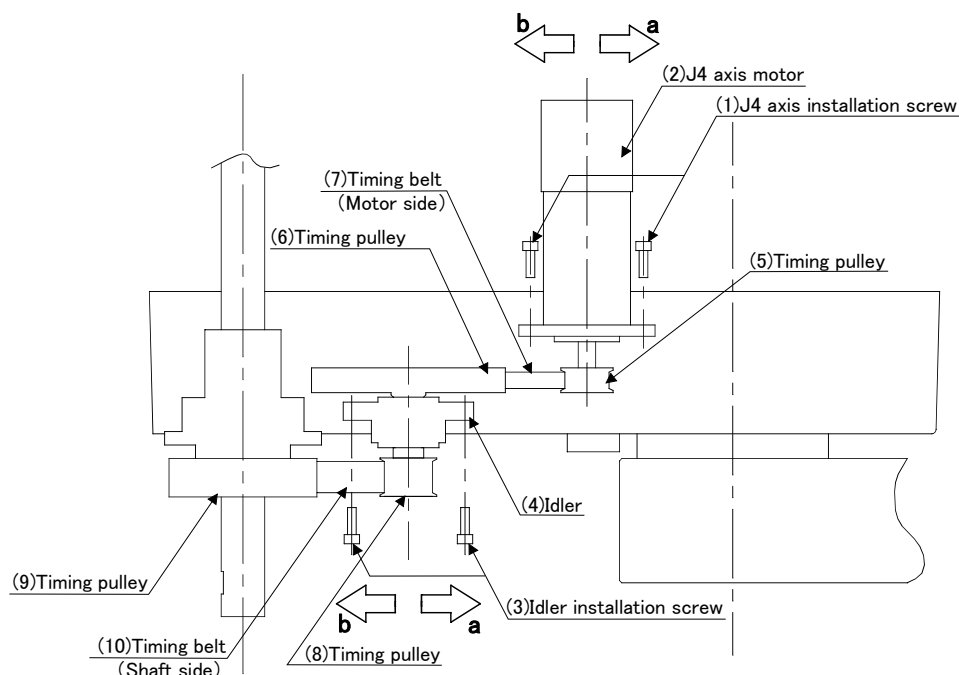

Fig.5-11 : Inspection, maintenance and replacement of J4-axis timing belt

■ Inspecting the J4 axis timing belt

- 1) Confirm that the robot controller power is OFF.
- 2) Refer to Fig. 5-3, and remove the No.2 arm cover-U and No.2 arm cover-L.
- 3) Visually confirm that the symptoms indicated in "(1)Timing belt replacement period" have not occurred with the timing belt. (At two locations, one at the first row and another at the second row)
- 4) Check the belt tension as shown in "(4)Timing belt tension" on page 71. Lightly press the center of the belt, and confirm that the value of belt slack is in following.

RH-6SDH series

(Motor side) Force to press the belt: apprpx. 2N / Flexure: 1.2mm.

(Shaft side) Force to press the belt: apprpx. 4N / Flexure: 1.2mm.

RH-12SDH/18SDH/20SDH series

(Motor side) Force to press the belt: approx. 2N / Flexure: 2.1mm.

(Shaft side) Force to press the belt: approx. 5N / Flexure: 1.7mm.

■ Adjusting the J4 axis timing belt

- 1) Carry out steps 1) and 2) indicated in "■ Inspecting the J4 axis timing belt" above.
- 2) Slightly loosen the two J4 motor installation screws (1) and the three idler installation screws (3). (Be careful not to overly loosen the screws.)
- 3) While checking the tension of the timing belt (10), move the idler (4) in the directions of the arrows indicated in the figure above. Lightly press the center of the belt, and confirm that the value of belt slack is in following.
 - RH-6SDH series: Force to press the belt : approx. 4N / Flexure: 1.2mm
 - RH-12SDH/18SDH/20SDH series: Force to press the belt: approx. 5N / Flexure: 1.7mm
- 4) While checking the tension of the timing belt (7), move the J4 motor (2) in the directions of the arrows indicated in the figure above. Lightly press the center of the belt, and confirm that the value of belt slack is in following.
 - RH-6SDH series: Force to press the belt : approx. 2N / Flexure: 1.2mm
 - RH-12SDH/18SDH/20SDH series: Force to press the belt: approx. 2N / Flexure: 2.1mm
- 5) The belt tension will increase when moved in the direction of arrow a, and will decrease when moved in the direction of arrow b.
- 6) If the belt is loosened too much when adjusting the tension causing it to come off the timing pulleys (5), (6), (8) and (9), or if the belt and pulley teeth engagement is deviated, the machine system's origin will deviate.
- 7) After adjusting, securely tighten the idler installation screws (3) and J4 motor installation screws (1). Improper tightening can cause the belt to loosen with vibration.

■ Replacing the J4 axis timing belt

- 1) Fig. 5-11 shows the methods for inspecting, adjusting and replacing the timing belt.
- 2) Turn off the controller power.
- 3) To reduce dislocation, try to keep the relative positions of the timing pulleys (5), (6), (8) and (9) as much as possible.
- 4) Loosen the three idler installation screws (3) and the two J4 axis motor installation screws (1) to remove the timing belts (7) and (10). If the hand prevents the belts from being removed, remove the hand when changing the belts.
- 5) Perform tension adjustment according to steps 3) to 6) in " ■ Adjusting the J4 axis timing belt" and "(4)Timing belt tension" on page 71. For more accurate tension adjustment, tighten the idler (4) with the idler installation screws (3) as shown in Fig. 5-12, while pulling the RH-6SDH series with a force of 135 N and the RH-12SDH/18SDH/20SDH series with a force of 115 N using a push-pull gauge. As shown in Fig. 5-13, it is recommended to tighten the J4 axis motor installation screws (1) while pushing the J4 axis motor (2) with a force of 65 N for the RH-6SDH series and 45 N for the RH-12SDH/18SDH/20SDH series using a push-pull gauge.
- 6) The position could deviate after the belt is replaced. Confirm that the position has not deviated.

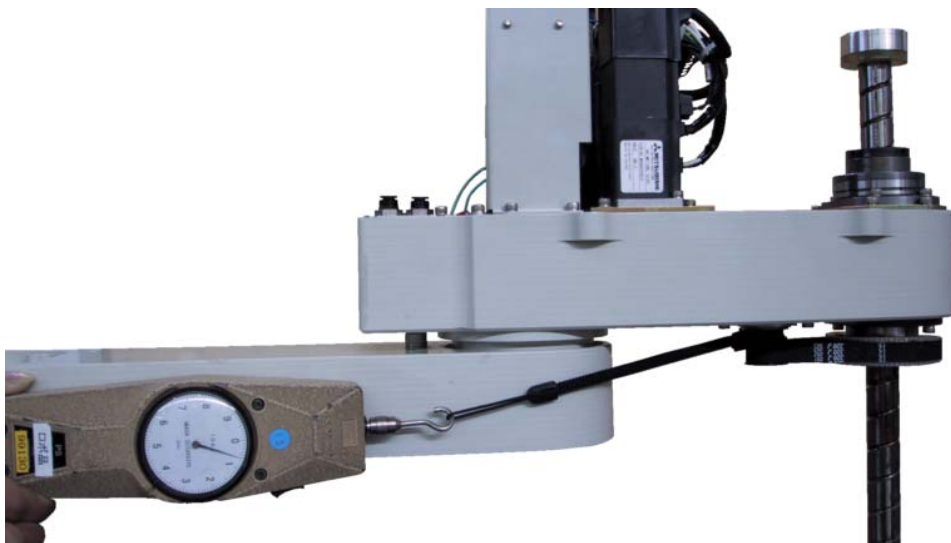
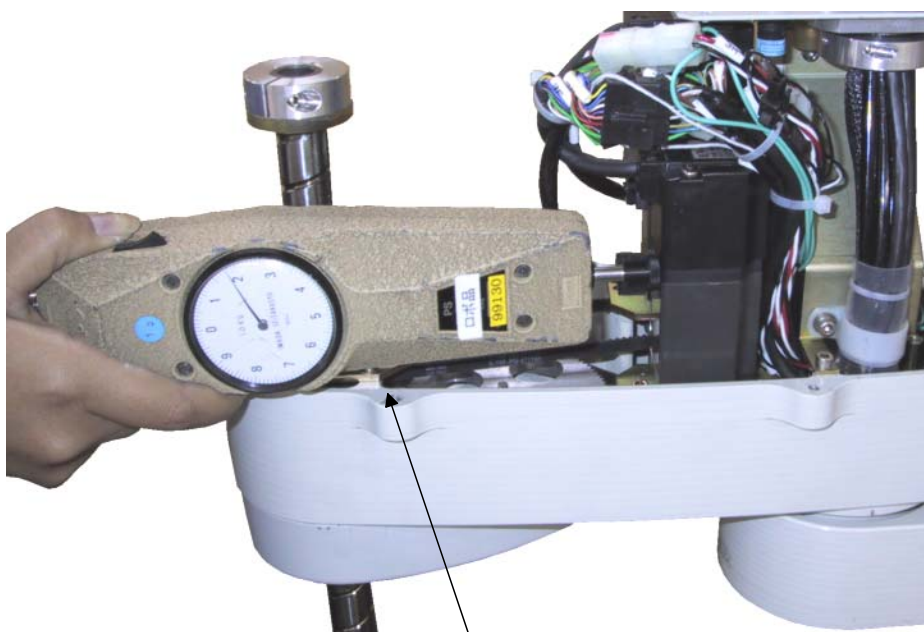

Fig.5-12 : J4 axis timing belt tension (1)



Remove the bracket attached vertically on the shaft fastening area.

Fig.5-13 : J4 axis timing belt tension (2)

(4) Timing belt tension

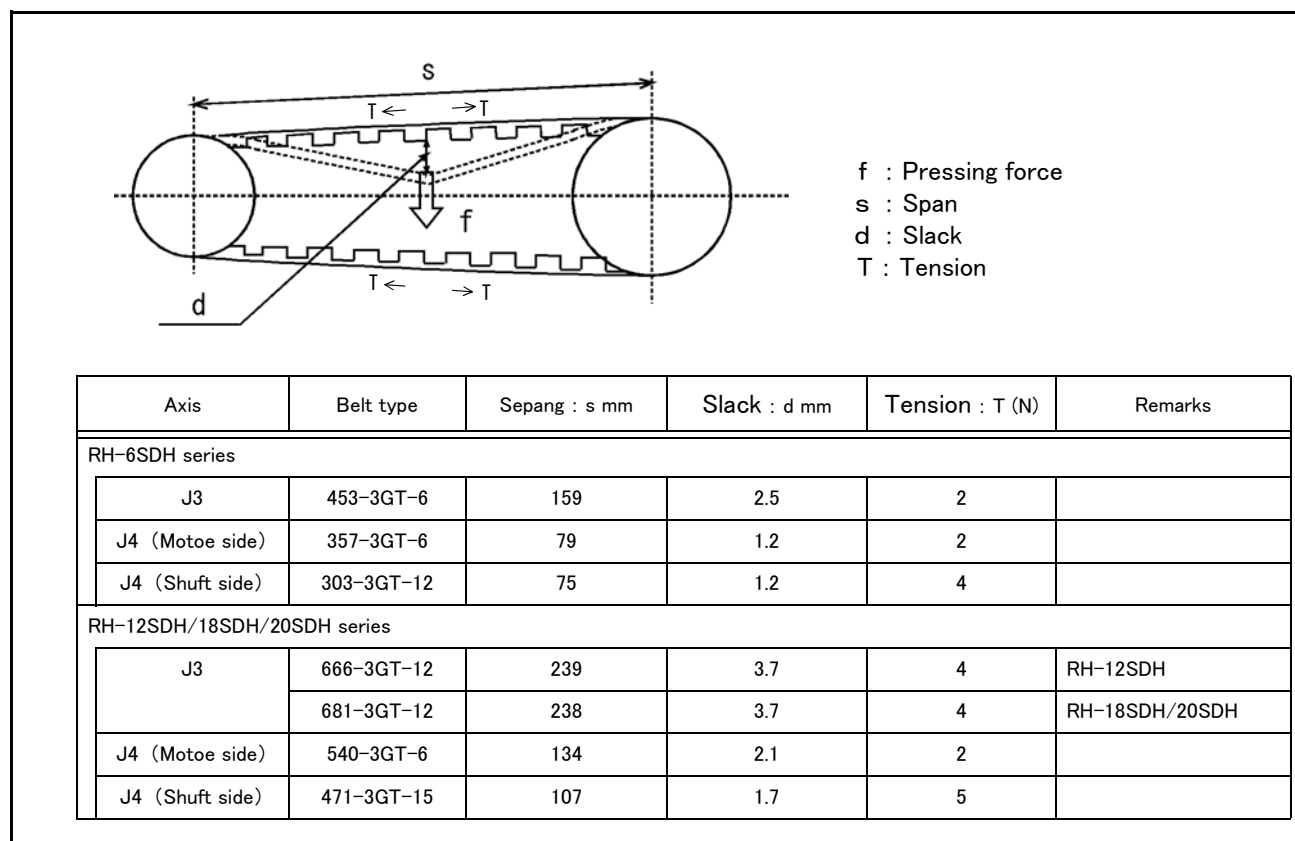

Fig.5-14 : Belt tension

The timing belt can satisfactorily convey the drive and keep a durable force only when it has an adequate tension. The belt tension should not be too tight or too loose. Instead, it should be adjusted to a degree that elasticity is felt when the belt is pressed with the thumb. If the belt tension is too weak, the belt loosening side will vibrate. On the other hand, if the belt tension is too strong, a sharp sound will be heard and the belt tension side will vibrate. The detailed adjustment (tension) is shown in [Fig. 5-14](#).

Check and adjust with the belt pressing force f and the slack amount d between span s .

5.3.5 Replacing Bellows

(1) How to Replace the Top Bellows

Refer to Fig. 5-15 and replace the top bellows.

- 1) Move the J3 axis to the position where the clamp ring becomes visible.
- 2) Turn off the robot controller's power supply.
- 3) Remove the clamp ring.
- 4) Loosen the M4 set screws (two pieces) next to part <1> installed at the top of the ball screw, and remove the top bellows from the No. 2 arm cover-U.
- 5) Remove the screws (four M3 x 8 screws) of installation part <2> of the bellows, and remove the bellows.
- 6) Install the new bellows (four M3 x 8 screws, Tightening torque 0.8Nm)
- 7) Align part <1> on the ball screw, and tighten the M4 set screws (two pieces) adjusting to the D cut surface.
- 8) Install the bellows on the No.2 arm cover-U with clamp ring.
- 9) Fill the clearance between part <1> and the ball screw with the liquid gasket described in "Table 5-9: Spare parts list" on page 81. or similar material.

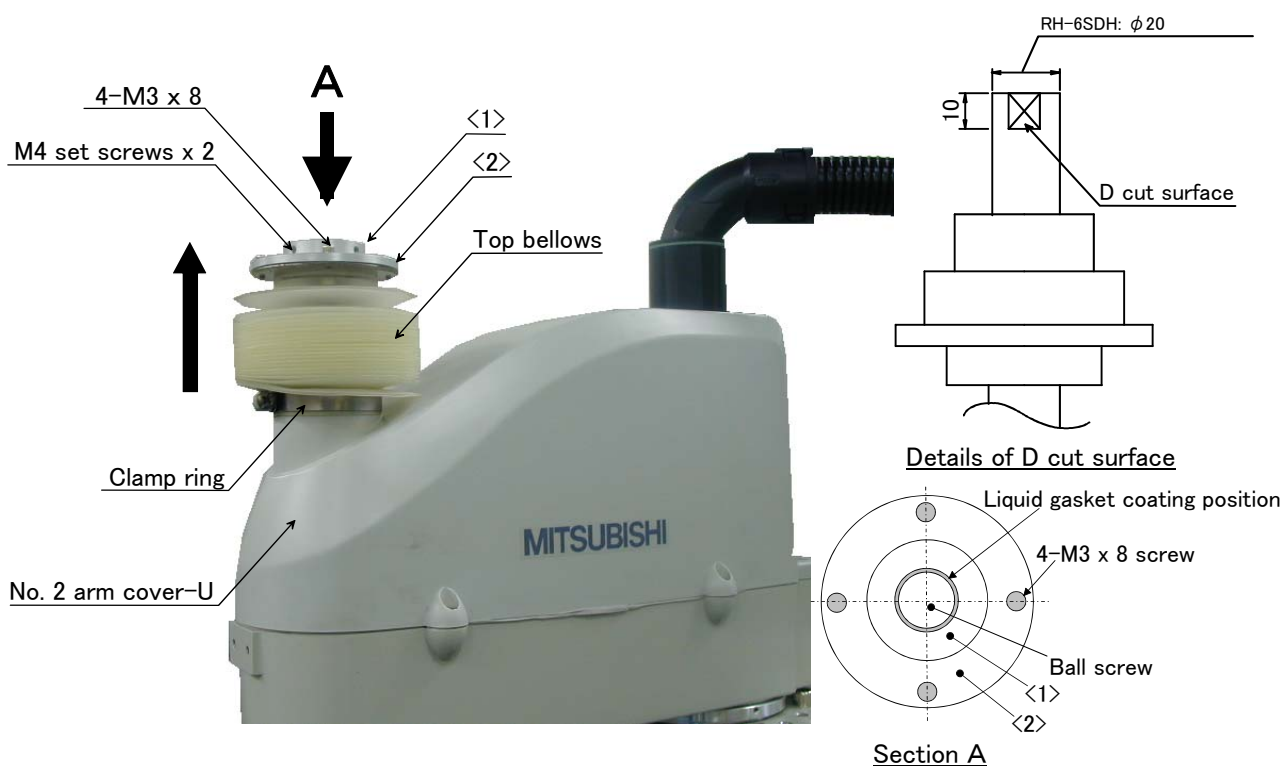

Fig.5-15 : Replace the top bellows(RH-6SDH series)

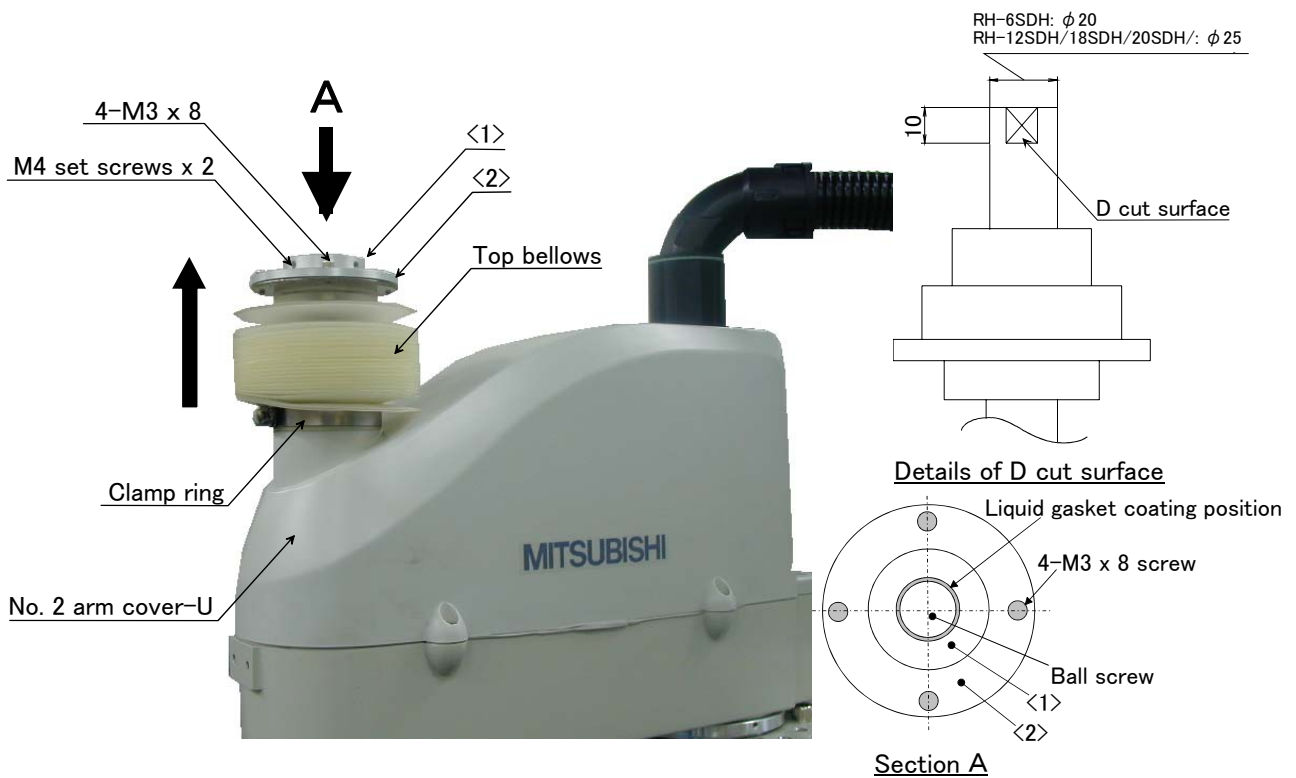

Fig.5-16 : Replace the top bellows(RH-12SDH/18SDH/20SDH series)

⚠ CAUTION

Replace the bellows in a place where there is no risk of contamination by dust and oil mist. If it must be replaced in a dust-filled area, be sure to remove as much dust as possible in advance before replacing it.

(2) How to Replace the Bottom Bellows

Refer to Fig. 5-17 and replace the top bellows.

- 1) Turn off the robot controller's power supply.
- 2) Remove the installation screws (three M4 screws) of the No. 2 arm cover-L <3>.
- 3) Loosen the two M4 set screws installed beside the part <4>, 30 mm above from the bottom edge of the ball screw, and remove the bottom bellows from the No. 2 arm cover-L.
- 4) Remove the screws (four M3 x 8 screws) of installation part <5> of the bellows, and remove the bellows.
- 5) Install the new bellows (four M3 x 8 screws, Tightening torque 0.8Nm)
- 6) Align part <4> to 30 mm above the bottom edge of the ball screw, and tighten the M4 set screws (two pieces) adjusting to the D cut surface.
- 7) Install the No. 2 arm cover-L <3> with the M4 screws (three pieces).
- 8) Fill the clearance between part <4> and the ball screw with the liquid gasket described in "Table 5-9: Spare parts list" on page 81. or similar material.

[Note] Check the condition of the sealant when installing the No. 2 arm cover-L onto No. 2 arm. Be sure to replace the sealant if it is dislocated and bent or crushed and does not return to its original shape. "Table 5-9 : Spare parts list" on page 81 provides a list of names of Norseal types.

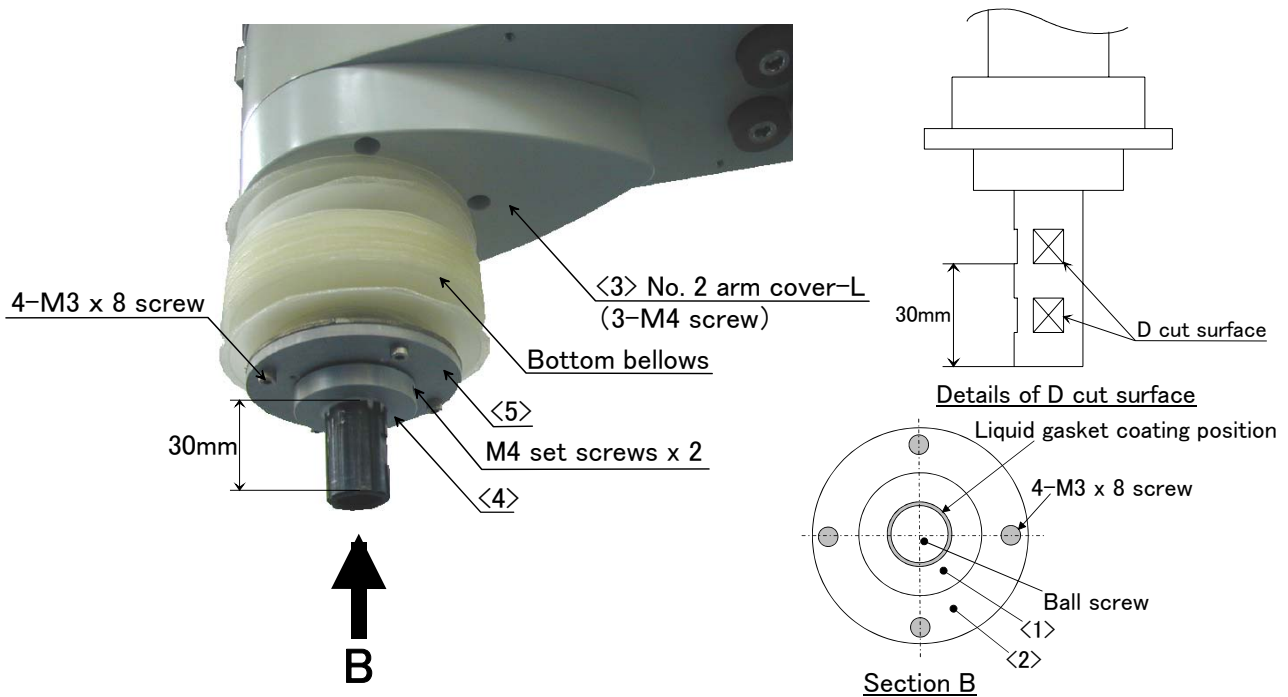

Fig.5-17 : Replace the top bellows

CAUTION

Replace the bellows in a place where there is no risk of contamination by dust and oil mist. If it must be replaced in a dust-filled area, be sure to remove as much dust as possible in advance before replacing it.

5.3.6 Lubrication

(1) Lubrication position and specifications

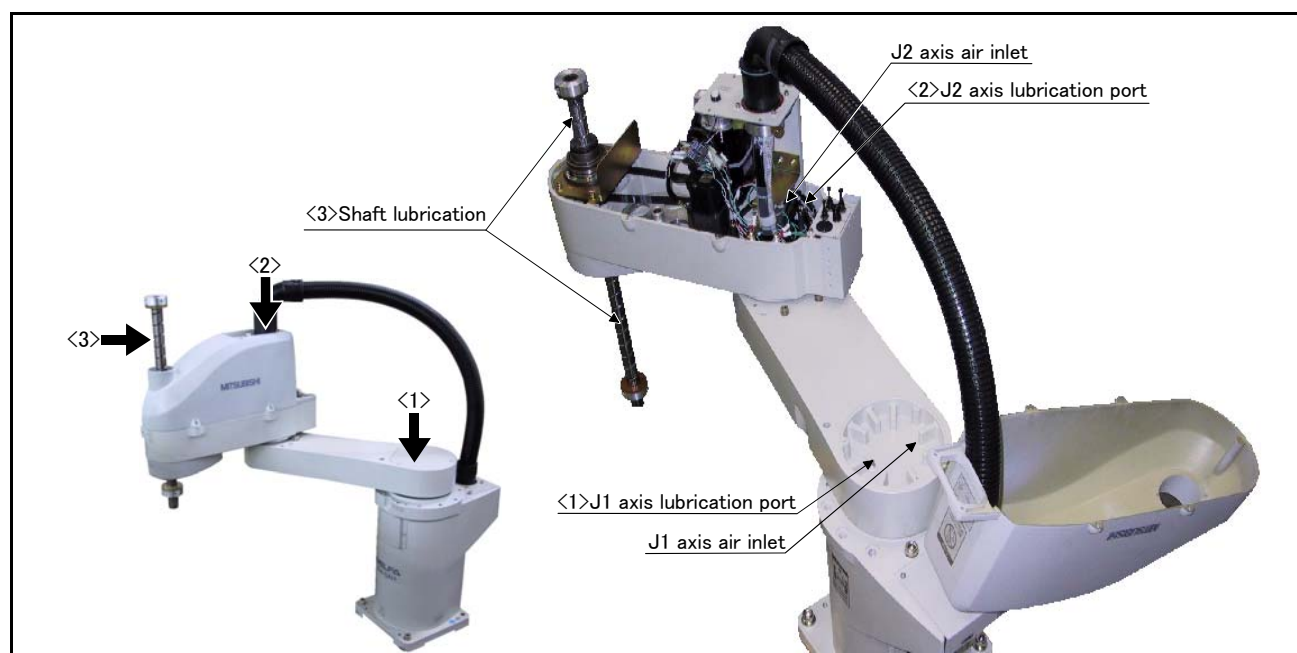

Fig.5-18 : Lubrication positions

Table 5-6 : Lubrication specifications

No.	Parts to be lubricated	Oiling method	Lubrication oil Default charge amount (maker)	Lubrication interval	Lubrication amount guide	Cover to remove
<1>	J1 axis reduction gears	Grease nipple WC-610(Only addition)	Grease Harmonic grease SK-1A (Japan Harmonic Systems)	6,000 Hr	3 g	J1 cover
<2>	J2 axis reduction gears			6,000 Hr	2 g	
<3>	Shaft	Wipe the old grease, and paint	Marutenpu PS No.2 (KYODO YUSHI CO.,LTD.)	Every 2000km movement	1g	No. 2 arm cover-U

The grease nipple position is shown in Fig. 5-18. The lubrication specifications for each place are shown in Table 5-6. When lubricating, remove the covers that need to be taken off by refer to "Fig.5-3 : Installing/removing the cover".

[Caution]

- The brands of grease given in Table 5-6 are those filled when the robot is shipped.
- The lubrication time is a cumulative value of the operation at the maximum speed. If the operation has been suspended, or if the designated speed is slow, the lubrication time can be lengthened in proportion.
- Depending on the robot operation state, the lubrication time will fluctuate, so determine the time according to the state so that the grease does not run out.
- The numbers in the Table 5-6 correspond to the supply positions in Fig. 5-18.

(2) Lubrication method to the J1, J2 axis

- 1) Refer to the "Fig.5-3 : Installing/removing the cover" and remove the covers.
- 2) Insert the grease shown in Table 5-6 using a grease gun from the lubrication grease nipple. Add only the specified amount of grease. Adding excess grease may cause grease to leak.
- 3) Replace the covers with the removal procedure in reverse.

[Note] Sealant is applied to the cover joint surface of the oil mist specification and clean specification models. Be sure to replace the sealant if it has been dislocated and bent or crushed and does not return to its original shape.

(Use liquid gasket and Norseal in "Table 5-9 : Spare parts list" on page 81.)

Moreover, in the case of oil mist specification and clean specification models, it is necessary to remove the top and bottom bellows. See Section "5.3.5 Replacing Bellows" on page 72 for details on how to remove them.

(3) Lubrication method to the shaft

- 1) Refer to “[Fig. 5-3 Installing/removing the cover](#)” on page 60,” remove the No. 2 arm cover-U.
- 2) Wipe the old grease off the shaft. At this time, wipe off the grease that has been scattered inside the No. 2 arm cover-U and the bracket attached vertically to the shaft fastening area.
- 3) Apply the specified amount of grease to the shaft. If too much grease is applied, grease may get scattered all over inside of the No. 2 arm. If the grease reaches the timing belt inside the No. 2 arm, the timing belt may deteriorate prematurely.
- 4) Attach the covers in the reverse order of their removal.

*In the case of oil mist specification and clean specification models, it is necessary to remove the top and bottom bellows. See Section “[5.3.5 Replacing Bellows](#)” on page 72 for details on how to remove them.



CAUTION

Replace the bellows in a place where there is no risk of contamination by dust and oil mist. If it must be replaced in a dust-filled area, be sure to remove as much dust as possible in advance before replacing it.

5.3.7 Replacing the backup battery

An absolute encoder is used for the position detector, so the position must be saved with the backup battery when the power is turned OFF. The controller also uses a backup battery to save the program, etc. These batteries are installed when the robot is shipped from the factory, but as these are consumable parts, they must be replaced periodically by the customer.

The guideline for replacing the battery is one year, but this will differ according to the robot's usage state.

Error No. 7520 :Battery consumption time is over

Error No. 133n :Encoder battery voltage low. (n indicates the axis number.)
(The encoder battery voltage of the robot arm is low.)

Error No. 7510 :Battery voltage low (R/C)
(The battery voltage of the controller is low.)

Error No. 7500 :No battery voltage
(The battery of the controller is depleted.)



CAUTION

If error No. 7500 occurs, the program data and other data in the controller is lost and it becomes necessary to load the data again.

If any of the battery-related errors above occur and the robot continues to be used, the data integrity of the memory cannot be guaranteed. If an error occurs, replace the batteries of both the robot arm and controller promptly.

It is also recommended to save programs and position data on the personal computer side via the personal computer support software and so forth in advance.

(1) Replacing the robot arm battery

CAUTION

Don't disconnect connector, etc. While replacing the battery, the encoder position data is saved by the power supplied from the controller. Thus, if the cable connection is incomplete, the encoder position data will be lost when the controller power is turned OFF. Several batteries are used in the robot arm, but replace all old batteries with new batteries at the same time.

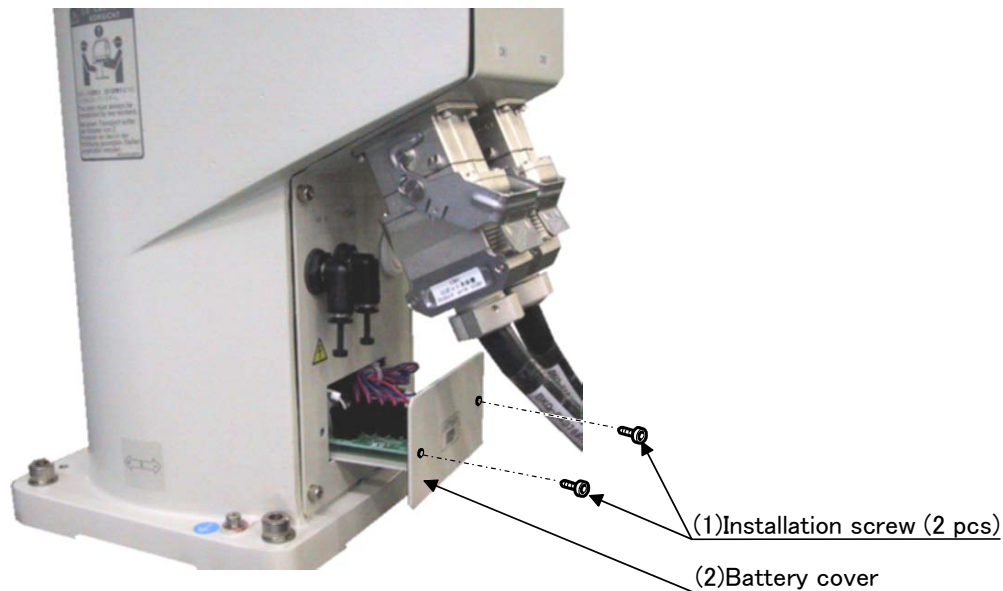

Fig.5-19 : Replacing the battery

- 1) Confirm that the robot arm and controller are connected with a cable.
- 2) Turn the controller control power ON.
The position data is retained by the power supplied from the controller while replacing the battery. Thus, if the cable is not connected correctly, or if the controller power is OFF, the position data will be lost.
- 3) Press the emergency stop button to set the robot in the emergency stop state. This is a measure for safety, and must always be carried out.
- 4) Remove the two installation screws (1), and remove the battery cover (2).
- 5) Remove the old battery from the holder, and disconnect the lead connector.
- 6) Insert the new battery into the holder, and connect the lead connector. Replace all batteries with new ones at the same time.
- 7) All the batteries should check that it has been exchanged newly. If the old battery is contained, generating heat and damaging may occur.
- 8) Carry out steps 4) to 6) in reverse to install the parts.
- 9) Initialize the battery consumption time.
Always carry out this step after replacing the battery, and initialize the battery usage time. Refer to the separate "Instruction Manual/Detailed Explanation of Functions and Operations" for details on the operation methods.

5.4 About Overhaul

Robots which have been in operation for an extended period of time can suffer from wear and other forms of deterioration. In regard to such robots, we define overhaul as an operation to replace parts running out of specified service life or other parts which have been damaged, so that the robots may be put back in shape for continued use. Overhaul interval for robots presumably varies with their operating conditions and thus with the degree of the equipment's wear and loss of performance. As a rule of thumb, however, it is recommended that overhaul be carried out before the total amount of servo-on time reaches the predetermined levels (24,000 hours for the robot body and 36,000 hours for the controller). (See Fig. 5-20.) For specific information about parts to be replaced and timing of overhaul, contact your local service representative.

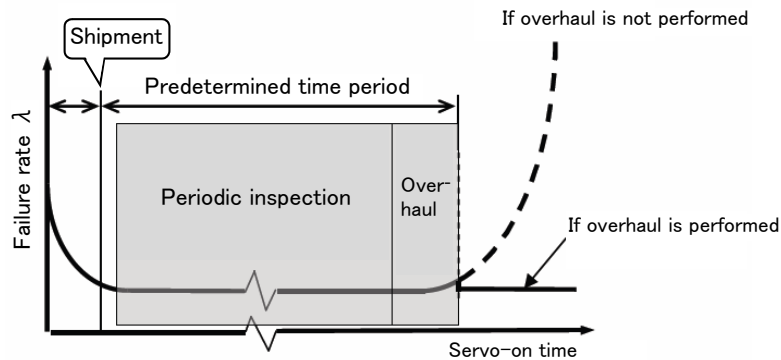

Fig.5-20 : Periodic inspection/overhaul periods

5.5 Maintenance parts

The consumable parts that must be replaced periodically are shown in Table 5-7, and spare parts that may be required during repairs are shown in Table 5-9. Purchase these parts from the dealer when required. Some Mitsubishi-designated parts differ from the maker's standard parts. Thus, confirm the part name, robot arm and controller serial No. and purchase the parts from the dealer.

Table 5-7 : Consumable part list

No.	Part name	Type ^{Note1)}	Usage place	Q'ty	Supplier
1	Grease		Reduction gears of each axis	An needed	Mitsubishi Electric
2	Lithium battery	A6BAT	In base	5	
RH-6SDH series					
3	Timing belt		J3 axis	1	Mitsubishi Electric
4			J4 axis motor side	1	
5			J4 axis shaft side	1	
RH-12SDH/18SDH/20SDH series					
6	Timing belt		J3 axis	1	Mitsubishi Electric
7			J4 axis motor side	1	
8			J4 axis shaft side	1	

Table 5-8 : Consumable part (packing) list

No.	part name	Details of configuration		Usage place		
		Packing name	Qty.	Cover name	Qty.	Sticking side
RH-6SDH standard specification						
1	PackingC (U164D339H01)	PackingC	1	J1 cover	1	Robot arm side
				No.2 arm cover U	2	Cover side
2	Solenoid valve box packing	Solenoid valve box packing	1	Solenoid valve box	1	Cover side
RH-6SDH clean or oil mist specification						
3	PackingA (U244D098H01)	PackingA	1	J1 cover	1	Robot arm side
				No.2 arm cover U	2	Cover side
				Bottom plate	1	Cover side
				CON plate G	1	Robot arm side
				No.2 arm cover L	1	Cover side
4	No.2 arm cover U packing	No.2 arm cover U packing	1	No.2 arm cover U (CBL bracket F)	1	Cover side
5	No.2 arm cover U packing B	No.2 arm cover U packing B	1	No.2 arm cover U (CON plate F)	1	Cover side
6	Base packing top	Base packing top	1	CONBOX cover	1	Robot arm side
7	Base packing bottom	Base packing bottom A	1		1	Robot arm side
		Base packing bottom B	1		1	Robot arm side
8	Battery bracket packing	Battery bracket packing	1	Battery cover	1	Cover side
9	PackingB (U244D170H01)	PackingB	1	Base cover	1	Robot arm side
10	Solenoid valve box packing	Solenoid valve box packing	1	Solenoid valve box	1	Cover side
RH-12SDH /18SDH/20SDH standard specification						
11	PackingC (U164D339H01)	PackingC	1	J1 cover	1	Robot arm side
				No.2 arm cover U	3	Cover side
12	Solenoid valve box packing	Solenoid valve box packing	1	Solenoid valve box	1	Cover side
RH-12SDH /18SDH/20SDH clean or oil mist specification						
13	PackingA (U244D098H01)	PackingA	1	J1 cover	1	Robot arm side
				No.2 arm cover U	2	Cover side
				Bottom plate	2	Cover side
				CON plate G	1	Robot arm side
				No.2 arm cover L	2	Cover side

No.	part name	Details of configuration		Usage place		
		Packing name	Qty.	Cover name	Qty.	Sticking side
14	No.2 arm cover U packing	No.2 arm cover U packing	1	No.2 arm cover U (CBL bracket F)	1	Cover side
15	No.2 arm cover U packing B	No.2 arm cover U packing B	1	No.2 arm cover U (CON plate F)	1	Cover side
16	Base packing top	Base packing top	1	CONBOX cover	1	Robot arm side
17	Base packing bottom	Base packing bottom A	1		1	Robot arm side
		Base packing bottom A	1		1	Robot arm side
18	Battery bracket packing	Battery bracket packing	1	Battery cover	1	Cover side
19	PackingB (U244D170H01)	PackingB	1	Base cover	1	Robot arm side
20	Solenoid valve box packing	Solenoid valve box packing	1	Solenoid valve box	1	Cover side

Table 5-9 : Spare parts list

No.	Names	Type ^{Note1)}	Usage place	Q'ty	Supplier
RH-6SDH series					
1	AC servo motor		J1 axis	1	Mitsubishi Electric
2			J2 axis	1	
3			J3 axis	1	
4			J4 axis	1	
5	Reduction gears		J1 axis	1	
6			J2 axis	1	
7	Ball screw spline		J3 axis (General environment and oil mist specification)	1	
8			J3 axis (clean specification)	1	
9	Top bellows		J3 axis (oil mist specification)	1	
10			J3 axis (clean specification)	1	
11	Bottom bellows		J3 axis (oil mist specification)	1	
12			J3 axis (clean specification)	1	
13	Liquid gasket		Bellows (clean and oil mist specification)	An needed	

No.	Names	Type ^{Note1)}	Usage place	Q'ty	Supplier
RH-12SDH/18SDH/20SDH series					
14	AC servo motor		J1 axis	1	Mitsubishi Electric
15			J2 axis	1	
16			J3 axis (RH-12SDH)	1	
17			J3 axis (RH-18SDH/20SDH)	1	
18			J4 axis (RH-12SDH)	1	
19			J4 axis (RH-18SDH/20SDH)	1	
20	Reduction gears		J1 axis (RH-12SDH55*, RH-12SHD75*)	1	
21			J1 axis (RH-12SDH85*, RH-18SDH, 20SDH series)	1	
22			J2 axis	1	
23	Ball screw spline		J3 axis (RH-12SDH: General environment and oil mist specification)	1	
24			J3 axis (RH-12SDH: clean specification)	1	
25			J3 axis (RH-18SDH: General environment and oil mist specification)	1	
26			J3 axis (RH-18SDH: clean specification)	1	
27			J3 axis (RH-20SDH: General environment and oil mist specification)	1	
28			J3 axis (RH-20SDH: clean specification)	1	
29	Top bellows		J3 axis (RH-12SDH/18SDH: oil mist specification)	1	
30			J3 axis (RH-12SDH/18SDH: clean specification)	1	
31			J3 axis (RH-20SDH: oil mist specification)	1	
32			J3 axis (RH-20SDH: clean specification)	1	
33	Bottom bellows		J3 axis (RH-12SDH/18SDH: oil mist specification)	1	
34			J3 axis (RH-12SDH/18SDH: clean specification)	1	
35			J3 axis (RH-20SDH: oil mist specification)	1	
36			J3 axis (RH-20SDH: clean specification)	1	
37	Liquid gasket		Bellows (clean and oil mist specification)	An needed	
38	Packing		Installation area of each cover (clean and oil mist specification) *Except the J1 cover and battery cover.	An needed	
39	J1 cover packing		J1 cover	1	
40	Battery bracket packing		Battery cover	1	

Note1) Confirm the robot arm serial No., and contact the dealer or service branch of Mitsubishi Electric Co., for the type.

5.6 Resetting the origin

The origin is set so that the robot can be used with a high accuracy. After purchasing the robot, always carry out this step before starting work. The origin must be reset if the combination of robot and controller being used is changed or if the motor is changed causing an encoder area. The types of origin setting methods are shown in [Table 5-10](#).

[Caution] If the old battery is replaced because it has been used up, it is necessary to set the origin again. Reset the origin using the jig method or mechanical stopper method or ABS origin method.

Table 5-10 : Origin setting method

No	Method	Explanation	Remarks
1	Origin data input method	The origin data set as the default is input from the T/B.	The setting method is explained in "2.3Setting the origin" on page 21 .
2	Mechanical stopper method	This origin posture is set by contacting each axis against the mechanical stopper.	The setting method is explained in "5.6.1Mechanical stopper method" on page 84 .
3	Jig method	The origin posture is set with the calibration jig installed.	The setting method is explained in "5.6.2Jig method" on page 92 .
4	User origin method	A randomly designated position is set as the origin posture.	The setting method is explained in "5.6.4User origin method" on page 100 .
5	ABS origin method	This method is used when the encoder backup data lost in the cause such as battery cutting.	Before using this method, the origin must be set with the other method with same encoder. The setting method is explained in "5.6.3ABS origin method" on page 98 .

5.6.1 Mechanical stopper method

The method for setting the origin with the transportation jig is explained below.

This operation is carried out with the T/B. Set the [MODE] switch on the front of the controller to "MANUAL", and set the T/B [ENABLE] switch to "ENABLE" to validate the T/B.

CAUTION The brakes are released here, and the J3 axis (shaft) is moved with both hands. For safety purposes, the brakes must be released by two workers.

(1) J1 axis origin setting(mechanical stopper)

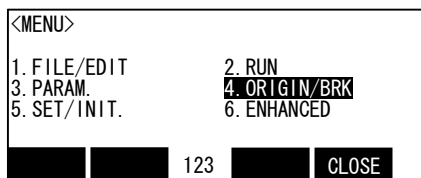

1) Press the [4] key on the menu screen, and display the Origin/Break selection screen.



2) With both hands, slowly move the J1 axis in - (minus) direction, and contact the axis against the mechanical stopper.

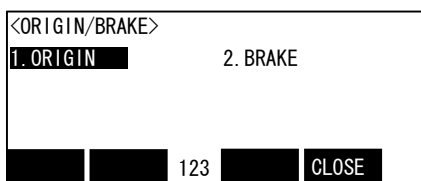

3) Press the [1] key, and display the Origin setting selection screen.

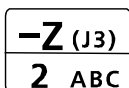
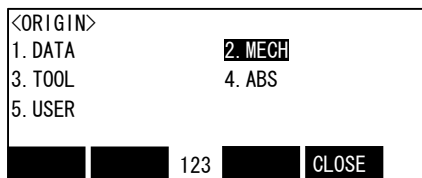

4) Press the [2] key, and display the Mechanical stopper selection screen.

<ORIGIN> MECH		
J1 (1)	J2 ()	J3 ()
J4 ()	J5 ()	J6 ()
J7 ()	J8 ()	
	123	CLOSE

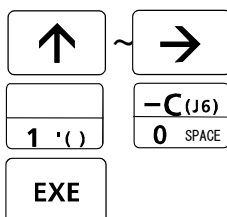

5) Input "1" into the J1 axis. Set "0" to other axes.

6) Press the [EXE] key, and display Confirmation screen.

<ORIGIN> MECH		
CHANGE TO ORIGIN. OK?		
Yes	123	No

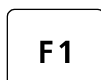

7) Press the [F1] key, and the origin position is set up.

<ORIGIN> MECH		COMPLETED
J1 (1)	J2 ()	J3 ()
J4 ()	J5 ()	J6 ()
J7 ()	J8 ()	
	123	CLOSE

8) Setting of the origin is completed.

9) Refer to "5.6.3ABS origin method" on page 98 in this manual, and record the origin data on the origin data seal.

◆◆◆ Release the brake ◆◆◆

Do cursor movement into the parenthesis of each axis by the arrow key. The brakes can be released only for the axis for which a "1" is displayed on the screen. If the brakes are not to be released, press the [0] key and display a "0". If the [F1] key on the teaching pendant or the enabling switch is detached while the brakes are released, the brakes will be work immediately.

◆◆◆ Select the axis of origin setting ◆◆◆

Do cursor movement into the parenthesis of each axis by the arrow key. The origin is set only for the axis for which a "1" is displayed on the screen. If the origin is not to be set, press the [0] key and display a "0".

(2) J2 axis origin setting(mechanical stopper)

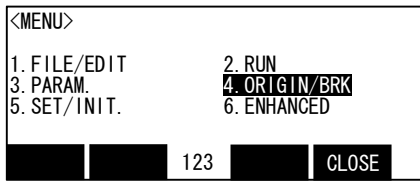

1) Press the [4] key on the menu screen, and display the Origin/Break selection screen.



2) With both hands, slowly move the J2 axis in + (plus) direction, and contact the axis against the mechanical stopper. J

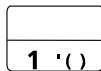
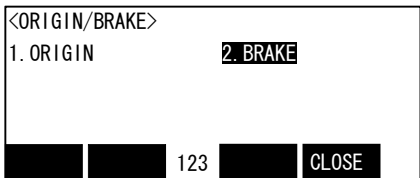

3) Press the [1] key, and display the Origin setting selection screen.

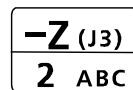
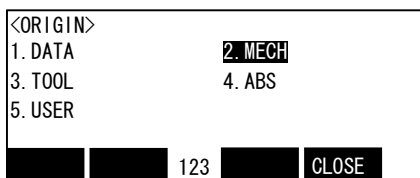

4) Press the [2] key, and display the Mechanical stopper selection screen.

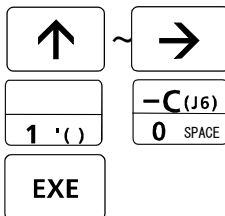
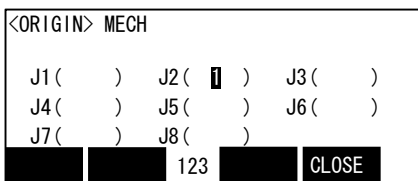

5) Input "1" into the J2 axis. Set "0" to other axes.

6) Press the [EXE] key, and display Confirmation screen.

<ORIGIN> MECH			
CHANGE TO ORIGIN. OK?			
Yes	123	No	

F1

<ORIGIN> MECH			COMPLETED
J1()	J2(1)	J3()	
J4()	J5()	J6()	
J7()	J8()		
	123	CLOSE	

7) Press the [F1] key, and the origin position is set up.

8) Setting of the origin is completed.

9) Refer to "5.6.3ABS origin method" on page 98 in this manual, and record the origin data on the origin data seal.

◆◆◆ Release the brake ◆◆◆

Do cursor movement into the parenthesis of each axis by the arrow key. The brakes can be released only for the axis for which a "1" is displayed on the screen. If the brakes are not to be released, press the [0] key and display a "0". If the [F1] key on the teaching pendant or the enabling switch is detached while the brakes are released, the brakes will be work immediately.

◆◆◆ Select the axis of origin setting ◆◆◆

Do cursor movement into the parenthesis of each axis by the arrow key. The origin is set only for the axis for which a "1" is displayed on the screen. If the origin is not to be set, press the [0] key and display a "0".

(3) J3 and J4 axis origin setting(mechanical stopper)

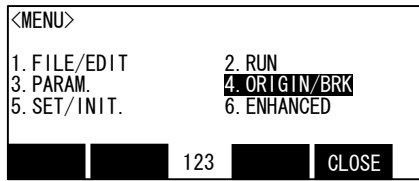

1) Press the [4] key on the menu screen, and display the Origin/Break selection screen.

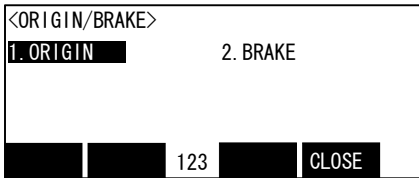

2) Press the [2] key, and display the Break release selection screen.

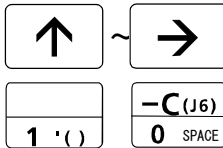
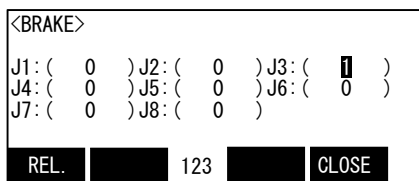

3) Release the brake of the J3 axis. Input "1" into the J3 axis. Set "0" to other axes.

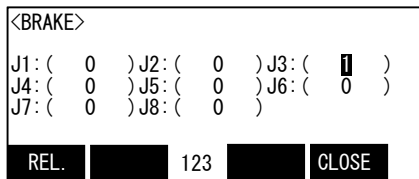

4) Confirm the axis for which the brakes are to be released.

5) Pressing the [F1] key is kept with the enabling switch of T/B pressed down. The brake is released while pressing the key.

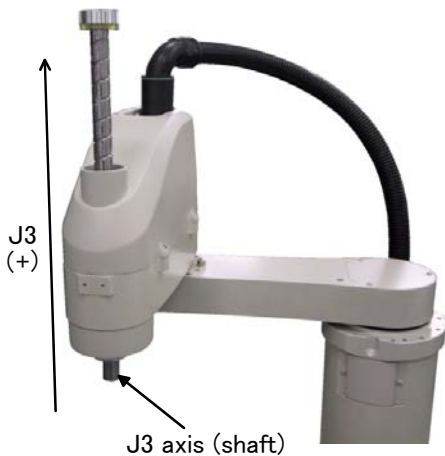

6) With both hands, slowly move the J3 axis in + (plus) direction, and contact the axis against the mechanical stopper.

CAUTION For safety purposes, the step for releasing the brakes must be carried out by two workers. One worker must operate the T/B, and the other must support the J3 axis (shaft). When the brake is released, the J3 axis could drop with its own weight.

CAUTION If [F1] key or enable switch of T/B is released, the brakes will be work immediately.

```

<BRAKE>
J1:( 0 ) J2:( 0 ) J3:( 1 )
J4:( 0 ) J5:( 0 ) J6:( 0 )
J7:( 0 ) J8:( 0 )
REL. 123 CLOSE
    
```

F4

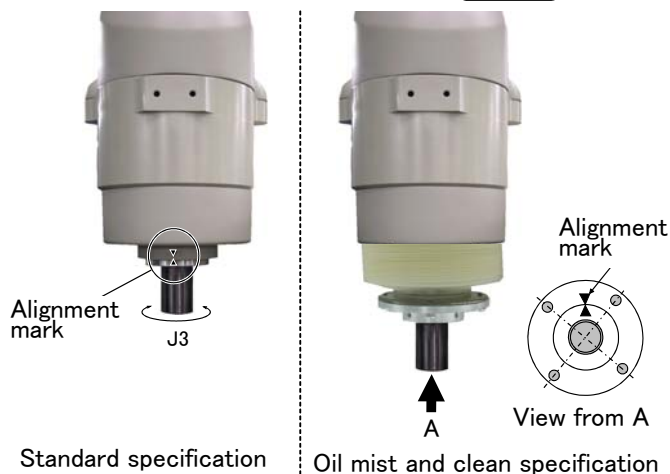

7) Detach the [F1] key and work the brake.
Press the [F4] key and return to the origin / brake screen.

8) Hold the J4 axis with your hand and rotate it slowly to match the alignment marks.

```

<ORIGIN/BRAKE>
1. ORIGIN      2. BRAKE
REL. 123 CLOSE
    
```

1 '()

9) Press the [1] key , and display the Origin setting selection screen.

```

<ORIGIN>
1. DATA      2. MECH
3. TOOL      4. ABS
5. USER
REL. 123 CLOSE
    
```

-Z (J3)
2 ABC

10) Press the [2] key , and display the Mechanical stopper selection screen.

```

<ORIGIN> MECH
J1 ( ) J2 ( ) J3 ( 1 )
J4 ( 1 ) J5 ( ) J6 ( )
J7 ( ) J8 ( )
REL. 123 CLOSE
    
```

↑ →
1 '() -C (J6)
0 SPACE
EXE

11) Input "1" into the J3 and J4 axis. Set "0" to other axes.

12) Press the [EXE] key , and display Confirmation screen.

```

<ORIGIN> MECH
CHANGE TO ORIGIN. OK?
Yes 123 No
    
```

F1

13) Press the [F1] key , and the origin position is set up.

14) Setting of the origin is completed.

```

<ORIGIN> MECH COMPLETED
J1 ( ) J2 ( ) J3 ( 1 )
J4 ( 1 ) J5 ( ) J6 ( )
J7 ( ) J8 ( )
REL. 123 CLOSE
    
```

15) Refer to "5.6.3ABS origin method" on page 98 in this manual, and record the origin data on the origin data seal.

◆◆◆ Release the brake ◆◆◆

Do cursor movement into the parenthesis of each axis by the arrow key. The brakes can be released only for the axis for which a "1" is displayed on the screen. If the brakes are not to be released, press the [0] key and display a "0". If the [F1] key on the teaching pendant or the enabling switch is detached while the brakes are released, the brakes will be work immediately.

◆◆◆ Select the axis of origin setting ◆◆◆

Do cursor movement into the parenthesis of each axis by the arrow key. The origin is set only for the axis for which a "1" is displayed on the screen. If the origin is not to be set, press the [0] key and display a "0".

(4) All axis origin setting

- 1) Refer to the paragraphs from “(1)J1 axis origin setting(mechanical stopper)” on page 84 to “(3)J3 and J4 axis origin setting(mechanical stopper)” on page 88 above for the description of how to adjust the origins of the J1 to J4 axes. Line up the ABS marks for the J4 axis and move the other axes into contact with the mechanical stoppers. At this point, the robot will have the posture shown below



<ORIGIN/BRAKE>	
1. ORIGIN	2. BRAKE
123	
CLOSE	

1 '()

- 2) Press the [1] key , and display the Origin setting selection screen.

<ORIGIN>	
1. DATA	2. MECH
3. TOOL	4. ABS
5. USER	
123	
CLOSE	

+Z (J3)
3 DEF

- 3) Press the [2] key , and display the Mechanical stopper selection screen.

<ORIGIN> MECH		
J1 (1)	J2 (1)	J3 (1)
J4 (1)	J5 ()	J6 ()
J7 ()	J8 ()	
123		
CLOSE		

↑

→

- 4) Input “1” into the J1 to J4 axis. Set “0” to other axes.

1 '()

-C (J6)
0 SPACE

- 5) Press the [EXE] key , and display Confirmation screen.

EXE

- 6) Press the [F1] key , and the origin position is set up.

<ORIGIN> MECH	
CHANGE TO ORIGIN. OK?	
Yes	No
123	

F1

- 7) Setting of the origin is completed.

<ORIGIN> MECH		COMPLETED
J1 (1)	J2 (1)	J3 (1)
J4 (1)	J5 ()	J6 ()
J7 ()	J8 ()	
123		CLOSE

- 8) Refer to “5.6.3ABS origin method” on page 98 in this manual, and record the origin data on the origin data seal.

5.6.2 Jig method

This method is using the origin setting tool. If the origin setting tool is required, please ask nearby dealer. The reference figure of the origin setting tool is shown in Fig. 5-21.

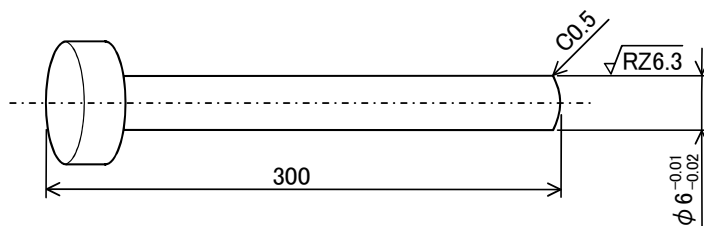

Fig.5-21 : Reference dimension of origin setting tool

The procedure of setting the origin with the origin setting tool is shown below.

Carry out this method for each axis.

First, set each axis by the origin position. There are the method of releasing the brake and adjusting with the origin position manually and the method of adjusting with the origin position by jog feed. Here, explain operation by brake release.

Then, do origin setting operation and set up the origin.

CAUTION

To ensure safety, the brake-release procedure described below should always be done by two persons.

This operation is carried out with the teaching pendant. Set the [MODE] switch on the front of the controller to "MANUAL", and set the [ENABLE] switch on the teaching pendant to "ENABLE" to enable the teaching pendant. Do the following operations, pressing down the enabling switch of T/B lightly.

(1) J1 axis origin setting

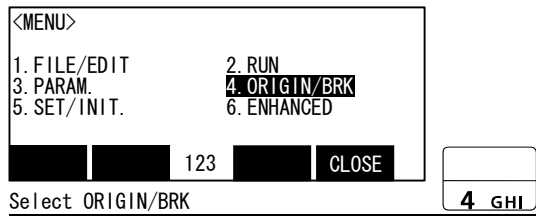

1) Press the [4] key on the menu screen, and display the Origin/Break selection screen.

RH-6SDH series

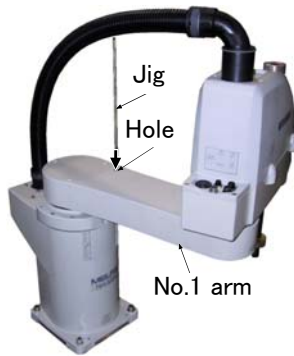

2) Move the J1 axis slowly toward the front using both hands. Align the pinhole of the No.1 arm and the pinhole at the base section, feed through the origin jig into the pinholes and fasten.

RH-12SDH/18SDH/20SDH series

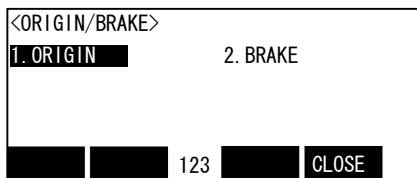
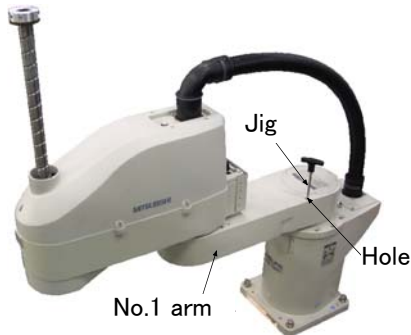

3) Press the [1] key, and display the Origin setting selection screen.

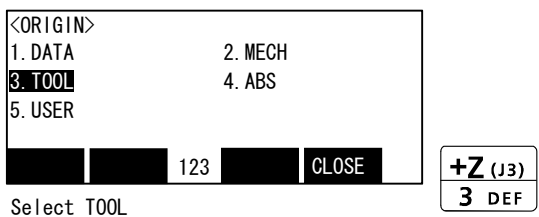

4) Press the [3] key, and display the Tool selection screen.

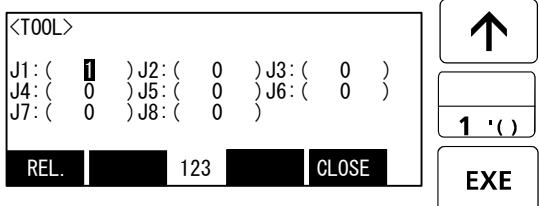

5) Input "1" into the J1 axis. Set "0" to other axes.

6) Press the [EXE] key, and display Confirmation screen.

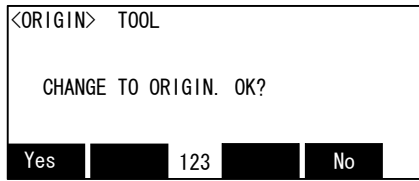

7) Press the [F1] key, and the origin position is set up.

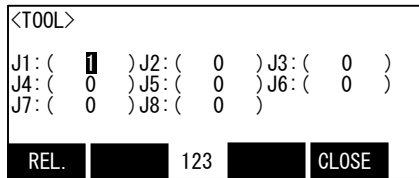

8) Setting of the origin is completed.

9) Refer to ["5.6.3ABS origin method" on page 98](#) in this manual, and record the origin data on the origin data seal.

◆◆◆ Release the brake ◆◆◆

Do cursor movement into the parenthesis of each axis by the arrow key. The brakes can be released only for the axis for which a "1" is displayed on the screen. If the brakes are not to be released, press the [0] key and display a "0". If the [F1] key on the teaching pendant or the enabling switch is detached while the brakes are released, the brakes will be work immediately.

◆◆◆ Select the axis of origin setting ◆◆◆

Do cursor movement into the parenthesis of each axis by the arrow key. The origin is set only for the axis for which a "1" is displayed on the screen. If the origin is not to be set, press the [0] key and display a "0".

(2) J2 axis origin setting

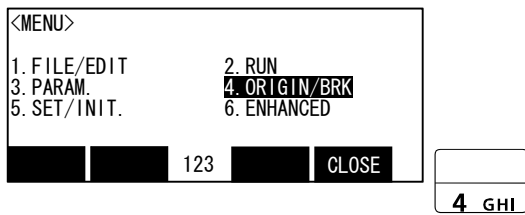

1) Press the [4] key on the menu screen, and display the Origin/Break selection screen.

RH-6SDH series

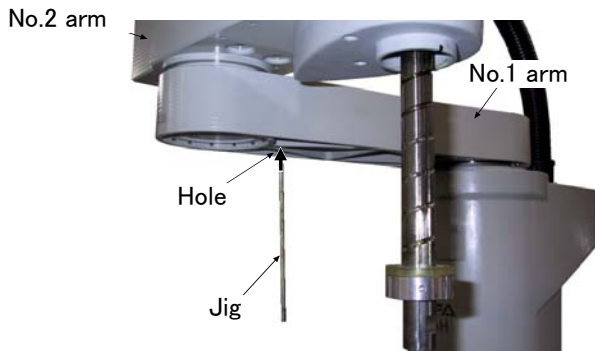

2) Slowly rotate the J2 axis 90° clockwise with both hands for RH-6SDH series. Slowly rotate the J2 axis 0° with both hands for RH-12SDH/18SDH/20SDH series. Align the pinholes of the No. 1 and No. 2 arms, feed through the origin jig into the pinholes and fasten.

RH-12SDH/18SDH/20SDH series

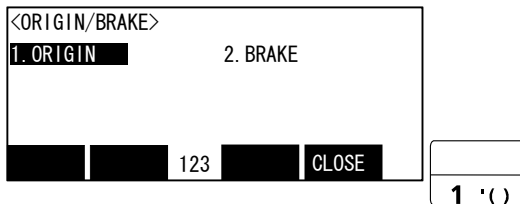
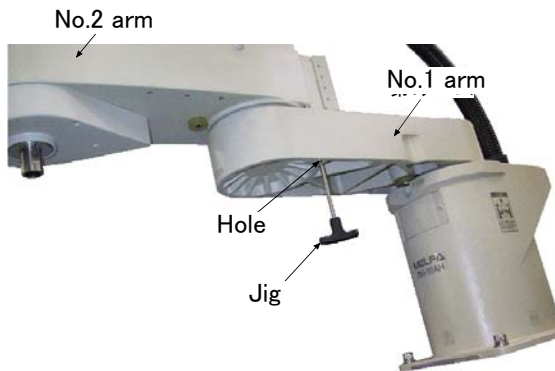

3) Press the [1] key, and display the Origin setting selection screen.

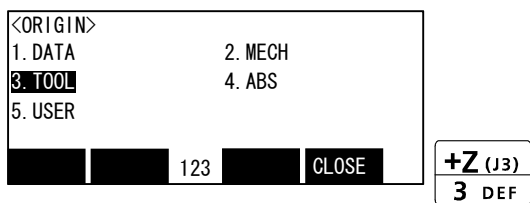

4) Press the [3] key, and display the Tool selection screen.

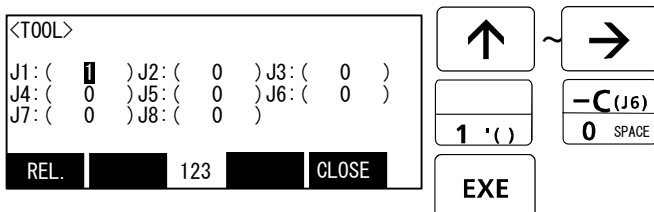

5) Input "1" into the J2 axis. Set "0" to other axes.

6) Press the [EXE] key, and display Confirmation screen.

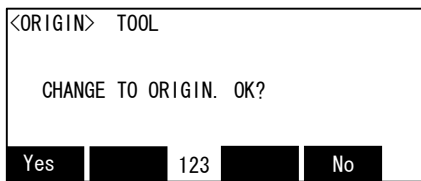

7) Press the [F1] key , and the origin position is set up.

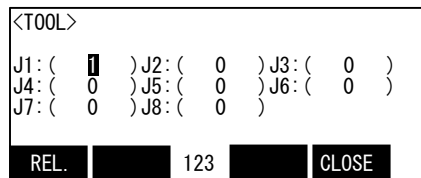

8) Setting of the origin is completed.

9) Refer to "5.6.3ABS origin method" on page 98 in this manual, and record the origin data on the origin data seal.

◆◆◆ Release the brake ◆◆◆

Do cursor movement into the parenthesis of each axis by the arrow key. The brakes can be released only for the axis for which a "1" is displayed on the screen. If the brakes are not to be released, press the [0] key and display a "0". If the [F1] key on the teaching pendant or the enabling switch is detached while the brakes are released, the brakes will be work immediately.

◆◆◆ Select the axis of origin setting ◆◆◆

Do cursor movement into the parenthesis of each axis by the arrow key. The origin is set only for the axis for which a "1" is displayed on the screen. If the origin is not to be set, press the [0] key and display a "0".

(3) J3 and J4 axis origin setting

Origin settings for the J3 and J4 axes must be performed at the same time.

The method of origin setting is the same as the mechanical stopper method. Refer to "(3)J3 and J4 axis origin setting(mechanical stopper)" on page 88, perform the required origin setting operations.

(4) All axis origin setting

- 1) Refer to the paragraphs from “(1)J1 axis origin setting” on page 93 to “(3)J3 and J4 axis origin setting” on page 96 above for the description of how to adjust the origins of the J1 to J4 axes. At this point, the robot will have the posture shown below

RH-6SDH series



RH-12SDH/18SDH/20SDH series

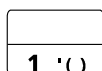
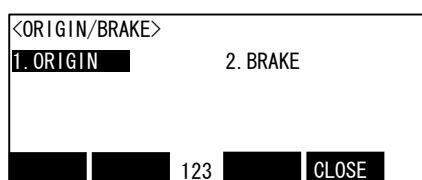

- 2) Press the [1] key , and display the Origin setting selection screen.

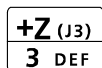
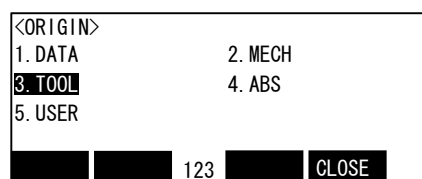

- 3) Press the [3] key , and display the Mechanical stopper selection screen.

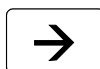
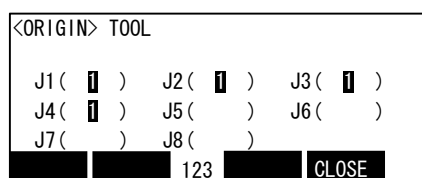

- 4) Input “1” into the J1 to J4 axis. Set “0” to other axes.

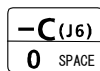

- 5) Press the [EXE] key , and display Confirmation screen.

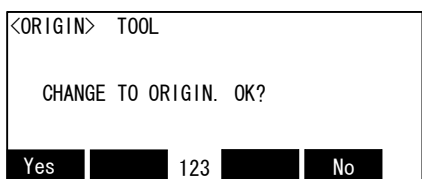

- 6) Press the [F1] key , and the origin position is set up.

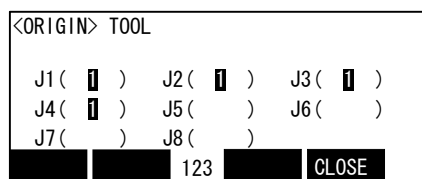

- 7) Setting of the origin is completed.

- 8) Refer to “5.6.3ABS origin method” on page 98 in this manual, and record the origin data on the origin data seal.

5.6.3 ABS origin method

When the origin setting of the robot is performed for the first time, this product records the angular position of the origin within one rotation of the encoder as the offset value. If the origin setting is performed according to the ABS origin method, this value is used to suppress variations in the origin setting operations and to reproduce the initial origin position accurately.

This operation is carried out with the teaching pendant. Set the [MODE] switch on the front of the controller to "MANUAL", and set the [ENABLE] switch on the teaching pendant to "ENABLE" to enable the teaching pendant. First, set to the ABS mark arrow of the axis for which the origin is to be set with jog operation. This can be set for all axes simultaneously or each axis independently.

When setting the ABS mark, always view the operations from the mark, and set at the end of the triangular mark. The positions where the ABS mark is attached are shown in below. Refer to "2.4 Confirming the operation" on page 27 for details on the jog operation.

Note that if the ABS marks are peeled off, the positions can be matched using the following alternative methods.
 *Match the ruling lines of the ABS mark mounting position surfaces. In this case, the installing and removing of the cover are unnecessary.

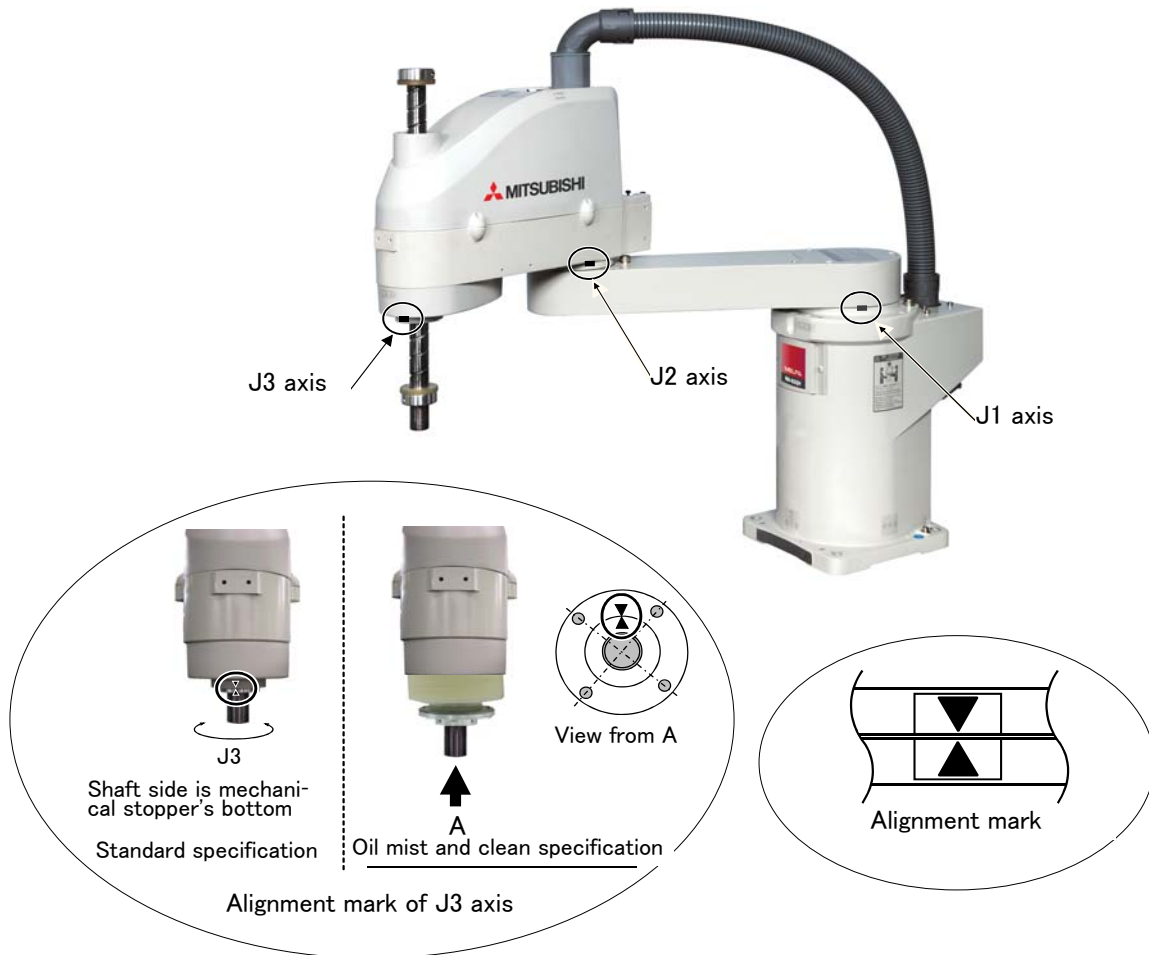

Fig.5-22 : ABS mark attachment positions

The procedures for setting the origin with the ABS method are explained below.

(1) Select the T/B

```

<MENU>
1. FILE/EDIT      2. RUN
3. PARAM.        4. ORIGIN/BRK
5. SET/INIT.     6. ENHANCED
REL. 123 CLOSE
  
```

```

  4 GHI
  
```

1) Press the [4] key on the menu screen, and display the Origin/Break selection screen.

```

<ORIGIN/BRAKE>
1. ORIGIN      2. BRAKE
REL. 123 CLOSE
  
```

```

  1 '()
  
```

2) Press the [1] key, and display the Origin setting selection screen.

```

<ORIGIN>
1. DATA      2. MECH
3. TOOL      4. ABS
5. USER
REL. 123 CLOSE
  
```

```

  4 GHI
  
```

3) Press the [4] key, and display the ABSI selection screen.

```

<ABS>
J1:( 1 ) J2:( 0 ) J3:( 0 )
J4:( 0 ) J5:( 0 ) J6:( 0 )
J7:( 0 ) J8:( 0 )
REL. 123 CLOSE
  
```

```

  ↑ ~ →
  1 '() → EXE
  
```

4) Input "1" into the axis to origin setting. Press the [EXE] key, and display Confirmation screen.

```

<ORIGIN> ABS
CHANGE TO ORIGIN. OK?
Yes 123 No
  
```

```

  F1
  
```

5) Press the [F1] key, and the origin position is set up.

```

<ABS>
J1:( 1 ) J2:( 0 ) J3:( 0 )
J4:( 0 ) J5:( 0 ) J6:( 0 )
J7:( 0 ) J8:( 0 )
REL. 123 CLOSE
  
```

This completes the setting of the origin with the ABS method.

5.6.4 User origin method

CAUTION Before using this method, the origin must be set with the other method. The setting method is explained in “Table 5-10 : Origin setting method” on page 83.

The procedure for setting the origin with the user origin method is explained below. This operation is carried out with the teaching pendant. Set the [MODE] switch on the front of the controller to “AMNUAL”, and set the [ENABLE] switch on the teaching pendant to “ENABLE” to enable the teaching pendant. The operation method is shown below.

When setting the origin for the first time using this method, carry out the operations in order from step 1). For the second and following time, move the robot arm to the user origin position with jog operation, and accurately position all axes. Then start the procedure from step 4).

- 1) Determine the user origin position
Move the robot to the position to be set as the origin with jog operation. Refer to “5.6.3ABS origin method” on page 98 for details on the jog operation.

CAUTION Choose the user origin position as the position where it doesn't move by the gravity. This position is left as a guideline to position all axes with jog operation when setting the origin again with this method.

- 2) Enter the JOINT jog mode, and display the joint coordinates on the teaching pendant screen. Record the value of the axis for which the origin is to be set.
- 3) Input the value recorded in the “user designated origin parameter (USRORG)”.
The parameter details and input methods are described in the separate “Instruction Manual/Detailed Explanation of Functions and Operations”. Refer to that manual and input the user designated origin position.

<MENU>
1. FILE/EDIT 2. RUN
3. PARAM. 4. ORIGIN/BRK
5. SET/INIT. 6. ENHANCED

123 CLOSE

4 GHI

- 4) Next, set the origin.
Display the menu screen.

- 5) Press the [4] key on the menu screen, and display the Origin/Break selection screen.

<ORIGIN/BRAKE>
1. ORIGIN 2. BRAKE

123 CLOSE

1 '()

- 6) Press the [1] key , and display the Origin setting selection screen.

<ORIGIN>
1. DATA 2. MECH
3. TOOL 4. ABS
5. USER

123 CLOSE

-A (J4)
5 JKL

- 7) Press the [5] key , and display the User selection screen.

```
<USER>
J1:( 1 )J2:( 0 )J3:( 0 )
J4:( 0 )J5:( 0 )J6:( 0 )
J7:( 0 )J8:( 0 )
REL. 123 CLOSE
```

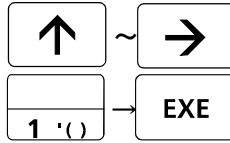

8) Input "1" into the axis to origin setting. Press the [EXE] key, and display Confirmation screen.

```
<ORIGIN> USER
CHANGE TO ORIGIN. OK?
Yes 123 No
```



9) Press the [F1] key, and the origin position is set up.

This completes the setting of the origin with the user origin method.

5.6.5 Recording the origin data

When the origin has been set with the jig method, record that origin data on the origin data label. With this, the origin can be set with the origin data input method the next time.

Confirm the origin data on the teaching pendant screen (origin data input screen). The origin data label is enclosed with the arm or attached on the back of the J1 cover.

The teaching pendant operation method and J1 cover removal method for confirming the origin data is the same as the methods for setting the origin with the origin data input method. Refer to ["2.3.2Setting the origin with the origin data input method" on page 22](#), and write the origin data displayed on the teaching pendant onto the origin label.

(1) Confirming the origin data label

Remove the J1 cover.

Refer to ["5.3.2Installing/removing the cover" on page 60](#), and remove the .

(2) Confirming the origin data

Confirm the value displayed on the teaching pendant's Origin Data Input screen.

Refer to ["2.3.2Setting the origin with the origin data input method" on page 22](#), ["\(5\)Inputting the origin data"](#) and display the Origin Data Input screen on the teaching pendant display screen.

(3) Recording the origin data

Write the origin data displayed on the teaching pendant to the origin data label attached to the back of the J1 cover. Refer to ["Fig.2-14 : Origin data label \(an example\)" on page 22](#), and ["Fig.2-15 : Correspondence of origin data label and axis" on page 25](#) for details on the origin data label.

(4) Installing the cover

Install the J1 cover removed in step ["\(1\)Confirming the origin data label"](#) above.

Refer to ["5.3.2Installing/removing the cover" on page 60](#), and replace the J1 cover.

This completes the recording of the origin data.

6 Appendix

Appendix 1 : Configuration flag

The configuration flag indicates the robot posture.

For the 6-axis type robot, the robot hand end is saved with the position data configured of X, Y, Z, A, B and C. However, even with the same position data, there are several postures that the robot can change to. The posture is expressed by this configuration flag, and the posture is saved with FL1 in the position constant (X, Y, Z, A, B, C) (FL1, FL2).

The types of configuration flags are shown below.

(1) RIGHT/LEFT

Indicates the location of the end axis relative to the line that passes through both the rotational center of the J1 axis and the rotational center of the J2 axis.



Fig.6-1 : Configuration flag (RIGHT/LEFT)

HEADQUARTERS

MITSUBISHI ELECTRIC EUROPE B.V. **EUROPE**
 German Branch
 Gothaer Straße 8
D-40880 Ratingen
 Phone: +49 (0)2102 / 486-0
 Fax: +49 (0)2102 / 486-1120

MITSUBISHI ELECTRIC EUROPE B.V. **CZECH REPUBLIC**
 Czech Branch
 Avenir Business Park, Radlická 714/113a
CZ-158 00 Praha 5
 Phone: +420 - 251 551 470
 Fax: +420 (0)251-551-471

MITSUBISHI ELECTRIC EUROPE B.V. **FRANCE**
 French Branch
 25, Boulevard des Bouvets
F-92741 Nanterre Cedex
 Phone: +33 (0)1 / 55 68 55 68
 Fax: +33 (0)1 / 55 68 57 57

MITSUBISHI ELECTRIC EUROPE B.V. **IRELAND**
 Irish Branch
 Westgate Business Park, Ballymount
IRL-Dublin 24
 Phone: +353 (0)1 4198800
 Fax: +353 (0)1 4198890

MITSUBISHI ELECTRIC EUROPE B.V. **ITALY**
 Italian Branch
 Viale Colleoni 7
I-20041 Agrate Brianza (MB)
 Phone: +39 039 / 60 53 1
 Fax: +39 039 / 60 53 312

MITSUBISHI ELECTRIC EUROPE B.V. **POLAND**
 Poland Branch
 Krakowska 50
PL-32-083 Balice
 Phone: +48 (0)12 / 630 47 00
 Fax: +48 (0)12 / 630 47 01

MITSUBISHI ELECTRIC EUROPE B.V. **SPAIN**
 Spanish Branch
 Carretera de Rubí 76-80
E-08190 Sant Cugat del Vallés (Barcelona)
 Phone: 902 131121 // +34 935653131
 Fax: +34 935891579

MITSUBISHI ELECTRIC EUROPE B.V. **UK**
 UK Branch
 Travellers Lane
UK-Hatfield, Herts. AL10 8XB
 Phone: +44 (0)1707 / 27 61 00
 Fax: +44 (0)1707 / 27 86 95

MITSUBISHI ELECTRIC CORPORATION **JAPAN**
 Office Tower "Z" 14 F
 8-12,1 chome, Harumi Chuo-Ku
Tokyo 104-6212
 Phone: +81 3 622 160 60
 Fax: +81 3 622 160 75

MITSUBISHI ELECTRIC AUTOMATION, Inc. **USA**
 500 Corporate Woods Parkway
Vernon Hills, IL 60061
 Phone: +1 847 478 21 00
 Fax: +1 847 478 22 53

EUROPEAN REPRESENTATIVES

GEVA **AUSTRIA**
 Wiener Straße 89
AT-2500 Baden
 Phone: +43 (0)2252 / 85 55 20
 Fax: +43 (0)2252 / 488 60

Koning & Hartman b.v. **BELGIUM**
 Woluwelaan 31
BE-1800 Vilvoorde
 Phone: +32 (0)2 / 257 02 40
 Fax: +32 (0)2 / 257 02 49

INEA BH d.o.o. **BOSNIA AND HERZEGOVINA**
 Aleja Lipa 56
BA-71000 Sarajevo
 Phone: +387 (0)33 / 921 164
 Fax: +387 (0)33 / 524 539

AKHNATON **BULGARIA**
 4 Andrej Ljapchev Blvd. Pb 21
BG-1756 Sofia
 Phone: +359 (0)2 / 817 6004
 Fax: +359 (0)2 / 97 44 06 1

AutoCont C.S. s.r.o. **CZECH REPUBLIC**
 Technologická 374/6
CZ-708 00 Ostrava-Pustkovec
 Phone: +420 595 691 150
 Fax: +420 595 691 199

B:ELECTRIC, s.r.o. **CZECH REPUBLIC**
 Mladoboleslavská 812
CZ-197 00 Praha 19 - Kbely
 Phone: +420 286 850 848, +420 724 317 975
 Fax: +420 286 850 850

Beijer Electronics A/S **DENMARK**
 Lykkegårdsvej 17
DK-4000 Roskilde
 Phone: +45 (0)46 / 75 76 66
 Fax: +45 (0)46 / 75 56 26

Beijer Electronics OY **FINLAND**
 Peltoie 37
FIN-28400 Ulvila
 Phone: +358 (0)207 / 463 540
 Fax: +358 (0)207 / 463 541

UTECO A.B.E.E. **GREECE**
 5, Mavrogenous Str.
GR-18542 Piraeus
 Phone: +30 211 / 1206 900
 Fax: +30 211 / 1206 999

AXICONT AUTOMATIKA KFT. **HUNGARY**
 (ROBOT CENTER) Reitter F. U. 132
HU-1131 Budapest
 Phone: +36 1 / 412-0882
 Fax: +36 1 / 412-0883

ALFATRADE Ltd. **MALTA**
 99, Paola Hill
Malta- Paola PLA 1702
 Phone: +356 (0)21 / 697 816
 Fax: +356 (0)21 / 697 817

HIFLEX AUTOM. TECHNIK B.V. **NETHERLANDS**
 Wolweverstraat 22
NL-2984 CD Ridderkerk
 Phone: +31 (0)180 - 46 60 04
 Fax: +31 (0)180 - 44 23 55

EUROPEAN REPRESENTATIVES

Koning & Hartman b.v. **NETHERLANDS**
 Haarlerbergweg 21-23
NL-1101 CH Amsterdam
 Phone: +31 (0)20 / 587 76 00
 Fax: +31 (0)20 / 587 76 05

Beijer Electronics AS **NORWAY**
 Postboks 487
NO-3002 Drammen
 Phone: +47 (0)32 / 24 30 00
 Fax: +47 (0)32 / 84 85 77

SIRIUS TRADING & SERVICES SRL **ROMANIA**
 Aleea Lacul Morii Nr. 3
RO-060841 Bucuresti, Sector 6
 Phone: +40 (0)21 / 430 40 06
 Fax: +40 (0)21 / 430 40 02

INEA SR d.o.o. **SERBIA**
 Izletnicka 10
SER-113000 Smederevo
 Phone: +381 (0)26 / 617 163
 Fax: +381 (0)26 / 617 163

CS MTrade Slovensko, s.r.o. **SLOVAKIA**
 Vajanskeho 58
SK-92101 Piestany
 Phone: +421 (0)33 / 7742 760
 Fax: +421 (0)33 / 7735 144

INEA d.o.o. **SLOVENIA**
 Stegne 11
SI-1000 Ljubljana
 Phone: +386 (0)1 / 513 8100
 Fax: +386 (0)1 / 513 8170

Beijer Electronics Automation AB **SWEDEN**
 Box 426
SE-20124 Malmö
 Phone: +46 (0)40 / 35 86 00
 Fax: +46 (0)40 / 93 23 01

Robotronic AG **SWITZERLAND**
 Schlachthofstrasse 8
CH-8406 Winterthur
 Phone: +41 (0)52 / 203 35 65
 Fax: +41 (0)52 / 203 35 66

GTS **TURKEY**
 Bayraktar Bulvari Nutuk Sok. No:5
TR-34775 Yukarı Dudullu-Ümraniye-İSTANBUL
 Phone: +90 (0)216 526 39 90
 Fax: +90 (0)216 526 3995

CSC Automation Ltd. **UKRAINE**
 4-B, M. Raskovoyi St.
UA-02660 Kiev
 Phone: +380 (0)44 / 494 33 55
 Fax: +380 (0)44 / 494-33-66

MIDDLE EAST REPRESENTATIVE

ILAN & GAVISH Ltd. **ISRAEL**
 24 Shenkar St., Kiryat Arie
IL-49001 Petah-Tiqva
 Phone: +972 (0)3 / 922 18 24
 Fax: +972 (0)3 / 924 0761

AFRICAN REPRESENTATIVE

CBI Ltd. **SOUTH AFRICA**
 Private Bag 2016
ZA-1600 Isando
 Phone: + 27 (0)11 / 977 0770
 Fax: + 27 (0)11 / 977 0761