



VARIABLE FREQUENCY DRIVES

MELTRAC-A140E

HIGH POWER

HIGH PERFORMANCE

FULLY DIGITAL

AC INVERTERS

Chassis Unit

INSTRUCTION MANUAL

NOTICE; READ ENTIRE MANUAL PRIOR TO
CONNECTING AND OPERATING
EQUIPMENT

We thank you for purchasing Mitsubishi Transistor Inverter Chassis Unit MELTRAC-A Series.

The Inverter serves to drive A. C. motor for Variable torque Application and Constant Torque general-purpose equipment. To prevent the Inverter Chassis Unit from getting an abnormality due to improper operation and handling of the Inverter Chassis Unit and to prolong the life of the Inverter Chassis Unit, we want the user to read carefully through this Manual prior to operating the Inverter Chassis Unit.

Moreover, please attach this Manual to a cubicle accommodating this Inverter Chassis Unit.

CONTENTS

| | |
|---|----|
| 1. PRECAUTIONS | 1 |
| 2. ACCEPTANCE INSPECTION | 3 |
| 3. STORAGE | 4 |
| 4. TRANSPORTATION | 4 |
| 5. INSTALLATION | 5 |
| 6. PERIPHERAL EQUIPMENT | 6 |
| 6.1 Selection guide | 6 |
| 6.2 Peripherals list | 7 |
| 7. STRUCTURE | 8 |
| 7.1 Removal/installation of front cover | 8 |
| 7.2 PARAMETER UNIT | 9 |
| 8. WIRING | 10 |
| 8.1 Wiring Instructions | 10 |
| 8.2 Main Circuit | 11 |
| 8.3 Control Circuit | 12 |
| 9. OPERATION | 14 |
| 9.1 Operation Mode | 14 |
| 9.2 Pre-Operation Checks | 14 |
| 9.3 Pre-Operation Settings | 15 |
| 9.4 Check Points during Test Run | 17 |
| 10. PARAMETER UNIT | 19 |
| 10.1 Structure of the Parameter Unit | 19 |
| 10.2 Functions of the Parameter Unit | 20 |
| 10.3 Parameters | 47 |

| | |
|--|-----|
| 11. EXPLANATION OF THE PARAMETERS | 49 |
| 11.1 Functions of the Parameters | 49 |
| 11.2 Operation using the Programmed Operation Function | 61 |
| 11.3 Five point flexible V/F Chavacteristic | 67 |
| 11.4 PU Disconnection Detection Function | 69 |
| 11.5 Auto Commission | 70 |
| 11.6 Selection of the Stall Prevention Function | 76 |
| 12. MAINTENANCE AND INSPECTION | 77 |
| 12.1 Precautions for Maintenance and Inspection | 77 |
| 12.2 Check Items | 77 |
| 12.3 Measurement of Main Circuit Voltages, Currents and Powers | 80 |
| 12.4 Checking the Inverter and Converter Modules | 82 |
| 12.5 Replacement of Parts | 83 |
| 13. TROUBLE SHOOTING | 84 |
| 13.1 Clearing Up the Cause of Fault Checking the Parameter unit display | 84 |
| 13.2 Faults and Check Points | 85 |
| 13.3 Protective Functions | 86 |
| 13.4 Alarm Code Unit | 88 |
| 14. SPECIFICATIONS | 89 |
| 14.1 MELTRAC-A140 | 89 |
| 14.2 Applicable motor capacity for Inverter power rating | 91 |
| 15. STANDARD CONNECTION DIAGRAM AND TERMINAL SPECIFICATIONS | 92 |
| 15.1 Internal Block Diagram | 92 |
| 15.2 Specifications of Input/Output Terminals | 93 |
| 16. OUTLINE DRAWINGS OF INVERTER CHASSIS UNIT AND DC REACTOR | 98 |
| 17. OPTION LIST | 101 |

1. PRECAUTIONS



Connect the accompanying DC Filter (reactor) to chassis unit (DC reactor should be cooled with forced ventilation).



Do not connect the power supply to the output terminals (U. V. W.).



Disconnect all the connector of the printed circuit boards when the insulation resistance measurement is performed.



Do not conduct the dielectric withstand voltage test.



Use the Inverter Chassis Unit by accommodating it in a suitable enclosure with the forced ventilation. (Refer to the separate panel enclosure building guidelines)
Refer to Instruction manual for important safety information regarding wiring (section 8.1).



Mount the Inverter Chassis Unit in the vertical position for use.



Remove the front panel of the Inverter Chassis Unit and make sure that the voltage across the capacitors are fully discharged (CHARGE on light is off).

Work must not be performed on the MELTRAC inverter, until the capacitors have been completely discharged.

Discharge of the capacitors will take a minimum of 15 minutes after input power is off.

Complete discharge less than 25VDC can be confirmed by checking the capacitor residual voltage using a DC voltmeter with 1188V. Scale and if no reading is obtained the scale should be changed to the next lower range, the voltage check should continue, progressively using the next lower scale until no reading is indicated on the lowest scale.

Complete discharge can also be confirmed by the CRG lamp, but as the CRG lamp cannot be illuminated without main power supply.

Charge LED is near the terminal block T2 on the center left of control PCB.



Do not insert/remove PU from inverter or dedicated extension cable socket without first removing power from inverter.



Set the acceleration time and deceleration time to the time period more than commercial acceleration time and free running deceleration time.



Make sure to ground the Inverter Chassis Unit in accordance with applicable electrical codes (grounding resistance 10 ohms or less or equivalent).



Do not use a motor which has a rated capacity in excess of that of the Inverter Chassis Unit, even if the motor load is lower.



When Walkie-Talkie radio wave equipment is used in the vicinity of the inverter, ensure that the front panel of the Inverter Chassis Unit or of the cubicle is closed, to prevent the Inverter malfunction.

● CAUTIONARY POINTS FOR INSTALLATION AND OPERATION OF THE INVERTER

1. Installation area

- (1) Make the length of a cable between the inverter and motor shortest possible (in order to reduce the impedance between the inverter and motor).
- (2) Avoid the area of high temperature and high humidity.
- (3) Don't use the inverter at any area which is exposed to much-dust, corrosive gas, oil splash or vibration.
- (4) If moisture or salinity exists near, take care to prevent it from entering the inverter unit.
 - * Since the force air cooling is used, specially keep in mind that the inverter is easily influenced by the atmosphere.

2. External wiring

- (1) Keep the main-circuit wiring and control-circuit wiring 30cm or more away from each other. If they are parallel to each other, minimize their lengths.
- (2) Ground the shields of the shield cables of the frequency commands at one point on the inverter side. (If they are grounded at two points on both sending and receiving sides, the circulating current will flow and it will sometimes become a noise source.)

Route the shield cable through another duct or steel conduit, separating it from other control cable or power cable.

3. Inverter Panel Cubicle (Enclosure) grounding

Ground the inverter box directly to the ground pole or the ground bus line (special Class 3 10Ω or less) but not through other box or equipment.
The ground cable size is 38mm² or more.

4. Noise countermeasure

Gain the operational power supply of the inverter box from the exclusive operation transformer. Provide the noise killer on the relay which is connected to the operational power supply in order to reduce noise. (As an example of the noise killer (for the circuit of 220V or lower), Okaya Denki brand CR50500BL is given.)

If the thyristor control unit is connected to the same bus line, additionally provide ACL on the thyristor control equipment side (in order to reduce the power voltage distortion).

5. Power voltage check for operation

Verify that the power voltage is within the tolerable variation range of the inverter.

(Even in case of the transient voltage drop soon after start of other load or the voltage drop due to the start current, it does not drop beyond the rated setting voltage of 300V or less.)

Moreover, in case of the 400V system, verify that the line ground is not the one-line type but the neutral point type or the isolated neutral type.

(The one-line ground of the line is not allowed in Electrical Facility Standard either.)

2. ACCEPTANCE INSPECTION

Check for shipping damage upon receiving your MELTRAC-A140E Chassis Unit.

If any damage is found, report it to the carrier immediately. Open the front panel of the Chassis Unit and check inside for any visual damage.

DO NOT ATTEMPT TO OPERATE THE MELTRAC-A140E IF ANY VISUAL DAMAGE EXISTS.

Check the installation conditions as follows.

- (1) Check whether the model of Chassis Unit is what you ordered?
- (2) Check whether all the following accompanying items are there or not?
- (3) Check the grounding conditions of the Chassis Unit.
- (4) Check all mounting and connection screws for tightness, damages of all wires and cables in the main circuit, control circuit, operation circuit and of incoming and outgoing terminal.
- (5) Check all connectors for proper seating in their sockets.
- (6) Check cooling air inlet.
- (7) Check cooling air outlet.
- (8) MELTRAC-A140E Chassis Unit require 380VAC~460VAC 3-phase 50Hz/60Hz input power.

Model and accessories Table

| | | | | | | |
|------------------------------|---|---------------|---------------|---------------|---------------|---------------|
| MODEL OF CHASSIS UNIT | MT-A140E-75K | MT-A140E-110K | MT-A140E-150K | MT-A140E-220K | MT-A140E-280K | MT-A140E-375K |
| MODEL OF DC FILTER (REACTOR) | T75MH175A | T50MH270A | T36MH350A | T25MH530A | T16MH672A | T14MH880A |
| REMARKS | Refer to this Instruction Manual and Panel building Manual. | | | | | |

3. STORAGE

When temporarily storing the Inverter Chassis Unit which has been unpacked and inspected, take care the followings:

- (1) To prevent the Inverter Chassis Unit from getting invasion of water and dust, place a desiccating agent in the Inverter Chassis Unit and seal it with vinyl sheet.
- (2) Store the Inverter Chassis Unit in a place free from direct sun shine and vibration.
- (3) Store the Inverter Chassis Unit in the rage of -10°C (14°F) to $+60^{\circ}\text{C}$ (140°F) of ambient temperature without condensation due to abrupt temperature change.
- (4) When storing the Inverter Chassis Unit for long time exceeding six months, check the storage condition of the Inverter Chassis Unit every six months.
- (5) When the Inverter Chassis Unit stored for 2 years or more is used, gradually increase both the control power supply and main circuit power voltage in the rate of approximately 40 Volts/minute to energize the capacitors. (When the rating voltage is directly applied to the Inverter Module Unit, it does not get damaged. However, its reliability may be degraded.)

When storing the Inverter Chassis Unit in a panel board, follow the conditions described above.

If it is difficult to seal the panel board with a vinyl sheet, seal the opening of the board and place a space heater inside the board to prevent occurrence of condensation.

4. TRANSPORTATION

When transporting the Inverter Module Unit, hang it using the hanging holes and transport it with care.

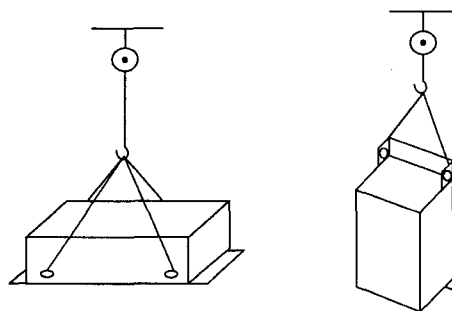

For the weight of the Inverter Chassis Unit, see "Paragraph 17. Specifications"

5. INSTALLATION

When the Inverter Chassis Unit is mounted into an force ventilated floor fixing enclosure, the reliability of the Inverter Chassis Unit just depends on the installation method and circumference of installation, so make sure the followings:

- (1) Mount the Inverter Chassis Unit in the vertical position.
- (2) Do not mount the Inverter Chassis Unit in a high-temperature and high-humidity environment (ambient temperature and relative humidity of the Inverter Module Unit should be less than 50°C (122°F) or less and 90% or less, respectively.)
- (3) Forcedly cool the accompanying DCL by air at 5 meter/sec. (0.003 miles/sec.)
- (4) Do not use the Inverter Chassis Unit in a condition where corrosive gas, splash of oil, and vibration exist.
- (5) If the Inverter Chassis Unit is used in a dusty environment, mount an air filter on to the air inlet of the accommodating board.
- (6) Since the Inverter Chassis Unit provides a forced ventilating fan, mount the Inverter Chassis Unit so that the resistance of the fan's air path becomes minimum.

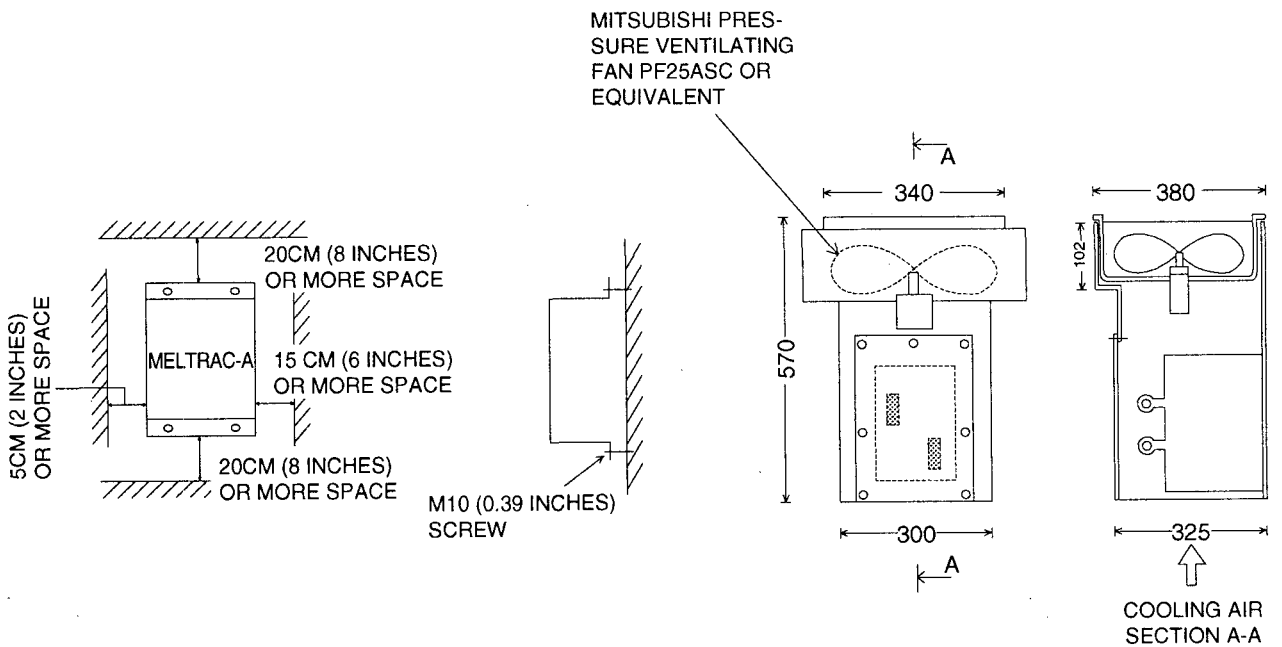

INVERTER CHASSIS UNIT INSTALLATION

**EXAMPLE OF DCL INSTALLATION
(IN CASE OF MT-A140E-75K OR MT-A140E-110K)**

6. PERIPHERAL EQUIPMENT

6.1 Selection guide

| Name (model) | Description | Installation |
|---|--|--------------|
| Power supply capacity | Capacity must exceed kVA described in "Power supply Capacity" standard specifications (p. 26). With the DC reactor installed, the power factor of power source will be approximately 95%. This value is less than or equal to the power factor when the motor is operated using commercial power. | |
| Line-side main circuit cable | Select proper cable size | |
| Circuit Breaker | Select proper input circuit breaker | |
| Cooling Fan | Install cooling fan to discharge heat (generated by inverter and DC reactor) outside of enclosure. | |
| AC contactor | Select appropriate size AC contactor | |
| AC reactor for power coordination | Install to prevent inverter malfunction if surge voltage is generated on power line from a thyristor converter or vacuum contactor on the same power system. Also install when the supply voltage imbalance is greater than 3%. | |
| Radio noise filter (FR-BIF) | Use to reduce noise in the AM radio frequency band which may be generated by the inverter. For use on inverter input side only. | |
| DC reactor for power factor improvement | Install the DC reactor specially designed for the MELTRAC-A. Power factor will be approximately 95%. | |
| Reactor connecting cable | Select proper cable size | |
| Brake unit (MT-BU) and discharge resistor (MT-BR) | This brake unit improves inverter braking capability. Use the brake unit in combination with a discharge resistor. | |
| Power regenerative converter (available soon) | Use when continuous or high braking capacity is required and when operating and stopping high inertial loads (GD^2) frequently. This unit is a high-performance brake unit that saves energy by regenerating power back to the power source. Unit advantages include no need for discharge resistors and significantly cooler operation. | |
| Sine-wave filter | This filter reduces motor noise. The next largest inverter for the motor rating should be selected | |
| Load-side main circuit cable | Select proper cable size | |

6.2 Peripherals list

This table is based on motors using Mitsubishi's standard design. (Note 1)

| Voltage | Variable torque motor rating (Note 6) | Applicable inverter type | DC reactor (accessory) | Fuseless breaker (Note 2) | Electromagnetic contactor (Note 3) | Wire (mm ²) (Note 4) | | | Exhaust fan (reference) (Note 5) |
|--------------|---------------------------------------|--------------------------|------------------------|----------------------------|------------------------------------|----------------------------------|-----------------|-----------------|---|
| | | | | | | R, S, T | U, V, W | P, P1 | |
| 400V to 460V | 75kW (100HP) | MT-A140E-75K | T75MH 175A | NF225 225A (NF225 225A) | S-K100 (S-K150) | (130A) 60 | (140A) 60 | (160A) 60 | EF-25ASB 1φ 100/110V 50/60Hz 12m ³ /min 3mmAq Suction port, 500 × 500mm or more |
| | 90kW (125HP) | MT-A140E-110K | T50MH 270A | NF225 225A (NF400 300A) | S-K150 (S-K180) | (157A) 60 | (174A) 60 | (192A) 80 | |
| | 110kW (150HP) | MT-A140E-110K | T50MH 270A | NF225 225A (NF400 350A) | S-K180 (S-K220) | (190A) 80 | (205A) 80 | (233A) 100 | |
| | 132kW | MT-A140E-150K | T36MH 350A | NF400 400A (NF400 400A) | S-K180 (S-K220) | (230A) 100 | (235A) 100 | (282A) 100 | |
| | 150kW (200HP) | MT-A140E-150K | T36MH 350A | NF400 400A (NF400 400A) | S-K300 (S-K300) | (260A) 125 | (285A) 125 | (318A) 150 | EF-30BSB 1φ 100/110V 50/60Hz 20m ³ /min 4mmAq Suction port, 500 × 500mm or more |
| | 160kW | MT-A140E-220K | T25MH 530A | NF400 400A (NF600 500A) | S-K300 (S-K400) | (278A) 125 | (305A) 150 | (340A) 2×100 | |
| | 185kW (250HP) | MT-A140E-220K | T25MH 530A | NF400 400A (NF600 500A) | S-K300 (S-K400) | (322A) 150 | (350A) 150 | (395A) 2×100 | |
| | 200kW | MT-A140E-220K | T25MH 530A | NF400 400A (NF600 600A) | S-K400 (S-K400) | (348A) 2×100 | (375A) 2×100 | (426A) 2×100 | |
| | 220kW (300HP) | MT-A140E-220K | T25MH 530A | NF600 500A (NF600 600A) | S-K400 (S-K600) | (383A) 2×100 | (410A) 2×100 | (470A) 2×100 | |
| | 250kW (350HP) | MT-A140E-280K | T16MH 672A | NF600 600A (NF600 600A) | S-K600 (S-K600) | (435A) 2×100 | (460A) 2×100 | (533A) 2×125 | |
| | 280kW (400HP) | MT-A140E-280K | T16MH 672A | NF600 600A (NF800 800A) | S-K600 (S-K600) | (487A) 2×125 | (515A) 2×125 | (596A) 2×150 | |
| | 375kW () | MT-A140E-375K | T14MH 880A | NF800 800A (NF800 800A) | S-K800 (S-K800) | (652A) 2×150 | (690A) 2×150 | (798A) 2×200 | |

Notes: 1. Motors of 75 kW or more are basically custom-made. Their characteristics depend on the number of poles, the protection form, and the manufacturer. Check the specifications of the motor actually used.

2. Types in parentheses are applied when devices are run on commercial power. Select an interruption capacity that is suitable for the short-circuit capacity of the power source. To use a leakage breaker, select one that accommodates harmonic surges and has a sensitivity current of 100 to 500 mA.

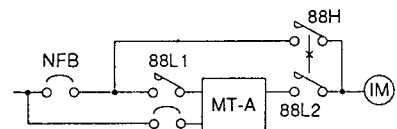

3. The model in parentheses is the contactor to be used on the motor side when run on commercial power.

4. For cables outside the panel (R, S, T, U, V, and W), a larger size may be selected than listed in this table depending on the cabling conditions and the cabling distance.

5. An exhaust fan is needed to discharge heat generated in the panel. Select a fan that can provide an adequate exhaust air flow taking into account the pressure loss caused by the filter at the inlet port.

6. HP rating is only at 460V.

7. STRUCTURE

7.1 Removal/installation of front cover

Turn the latch hook on the lower area of the cover with coin, and strongly pull the cover, and the lower area will be opened.

For removal, slightly pull up the cover to disengage the hinge hook.

* The parameter unit will remain on the body side.

For installation, reverse the above procedure.

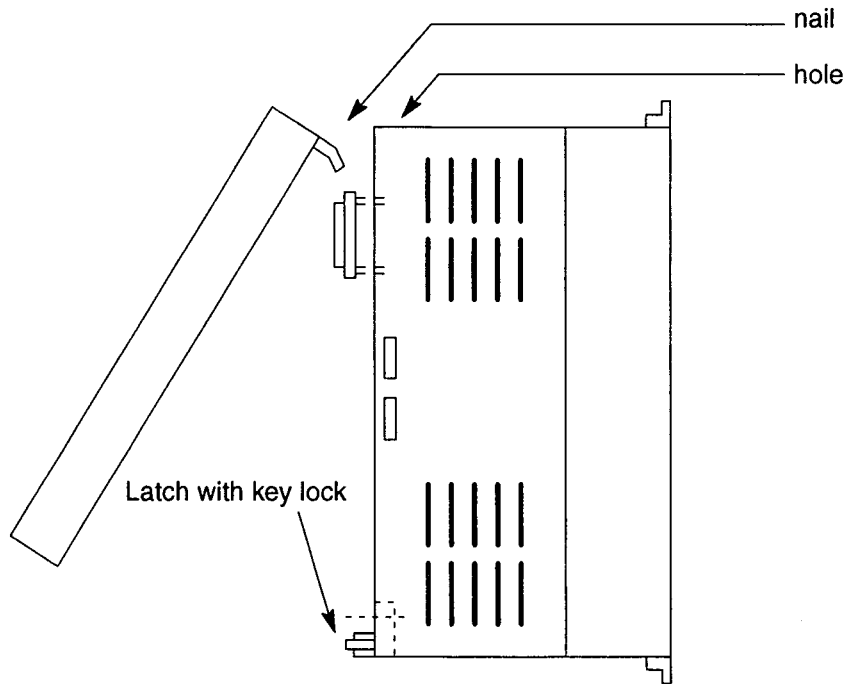

7.2 PARAMETER UNIT

Installation of the Parameter Unit

The PU may either be installed directly to the inverter or connected to the inverter by the optional cable so that it may be hand-held or installed to a panel. The PU may be installed and removed when the inverter is powered up or running.

(1) Direct Installation to the Inverter

The PU is used on the front cover of the inverter (electrically coupled by the connector). For the model not equipped with the PU, remove the accessory cover from the inverter front cover and install the PU to that position.

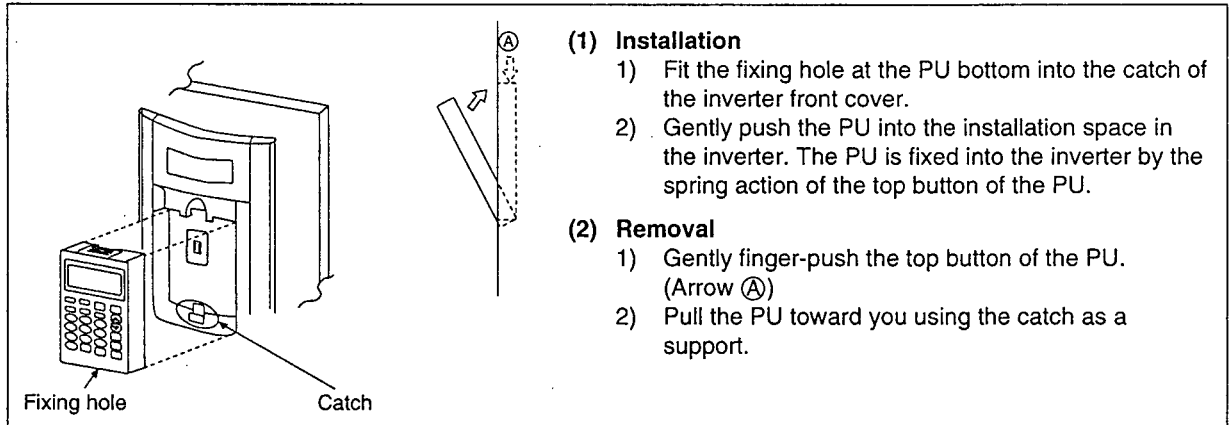

[CAUTION] The PU should only be installed on the inverter when the inverter cover is installed.

(2) Connection Using the Cable

The PU may be installed not only to the inverter but also on the surface of a panel or may be hand-held for adjustment, maintenance, inspection, etc. In this case, the dedicated cable (option) is required for connection of the PU and inverter.

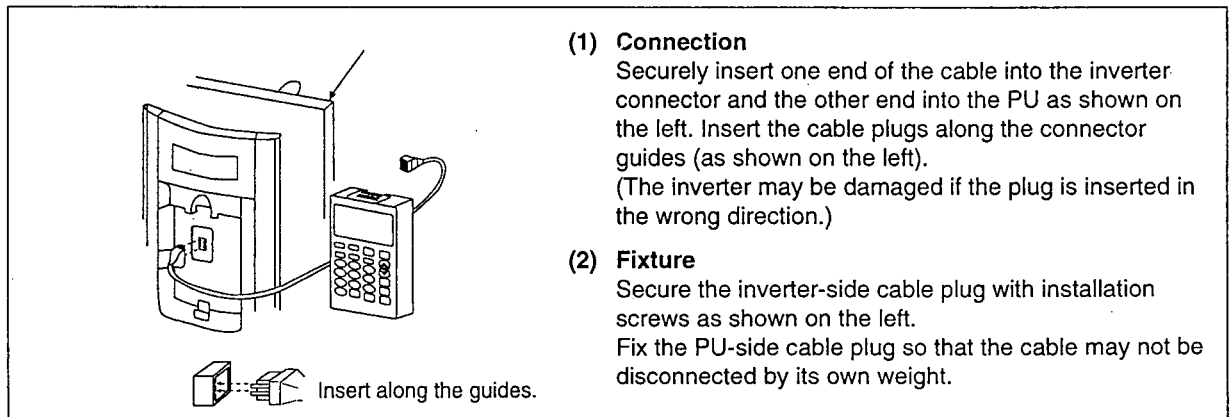

[CAUTION] The dedicated PU cable (option) may only be used to connect between the PU and inverter.

8. WIRING

8.1 Wiring Instructions

Note the following when wiring to prevent miswiring and misuse.

Notes on Wiring

- (1) The power must not be applied to the output terminals (U, V, W), otherwise the inverter will be damaged.
- (2) Connect only the recommended optional brake resistor between the terminals P and N. In addition, these terminals must not be shorted.
- (3) Use sleeved solderless terminals for the power supply and motor cables.
- (4) The common terminals SD, 5 and SE of the control circuit (isolated from each other) must not be grounded.
- (5) Use shielded or twisted cables for connection to the control circuit terminals and run them away from the main and power circuits (such as 200V relay sequence circuit).
- (6) When rewiring after operation, make sure that the inverter LED has gone off and that the charge lamp on the printed circuit board or beside the terminal block has gone off.
- (7) The cable size for connection to the control circuit terminals should be 0.75mm². Run the cables so that they do not occupy much of the control box terminal block space.
- (8) When the power supply voltage is special (Over 440V), remove the jumper between terminals X-X1 on the control PCB.

Design Information to Be Checked

- (1) The inverter will be damaged not only by miswiring but also by a sneak current from the power supply if there is a commercial power supply switch-over circuit shown on the right. To prevent this, provide electrical and mechanical interlocks for MC1 and MC2.

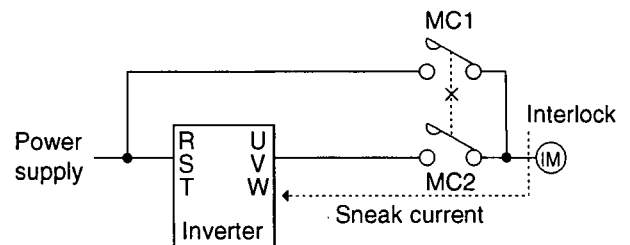

- (2) If the start signal (start switch) remains on after a power failure, the inverter will automatically restart as soon as the power is restored. When a machine restart is to be prevented at power restoration, provide a magnetic contactor MC in the primary circuit of the inverter and also make up a sequence which will not switch on the start signal.
- (3) Since input signals to the control circuit are at a low level, use two parallel micro signal contacts or a twin contact for contact inputs to prevent a contact fault.
- (4) Do not apply a voltage to the contact input terminals (e.g. STF) of the control circuit.
- (5) Do not apply a voltage directly to the alarm output signal terminals (A, B, C). Apply a voltage via a relay coil, lamp, etc. to these terminals.
- (6) Since the wiring for the frequency setter and frequency indicator is a weak-current circuit, prevent the wiring from being induced by other power cable, control cable or equipment. Use the shield cable for the setter and the twist cable for the indicator, and pass the cables through the exclusive duct.

(7) When parallelly routing the control cable, the main-circuit and other 200V or higher power cable, keep them 30cm or more away from each other but don't run them near each other. If any control cable, main-circuit power cable and other 200V or higher cable are inevitably crossed each other, cross them at a right angle to each other and keep them 5cm or more away from each other.

8.2 Main Circuit

(1) Connection of the power supply and motor

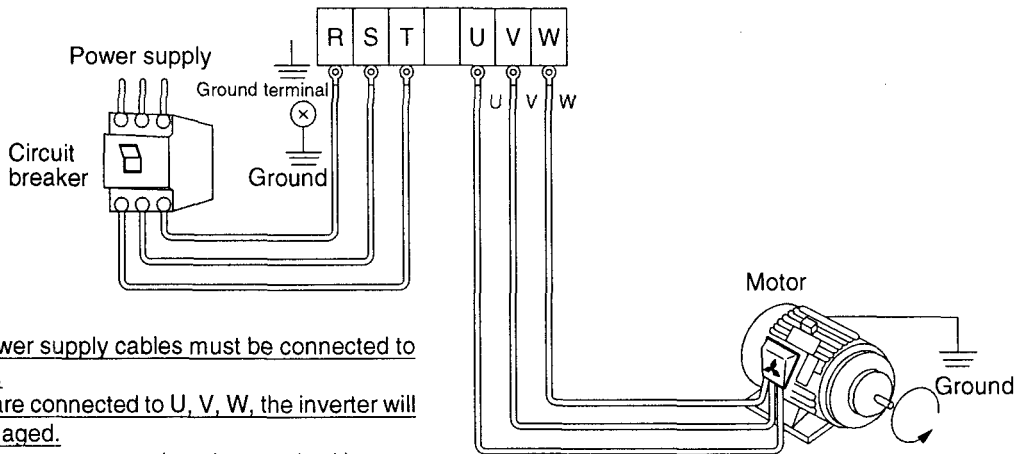

The power supply cables must be connected to R, S, T.
 If they are connected to U, V, W, the inverter will be damaged.
 (Phase sequence need not be matched.)

Fig. 8.1

Connect the motor to U, V, W.

In the above connection, turning on the forward rotation switch (signal) rotates the motor in the counterclockwise (arrow) direction when viewed from the load shaft.

Note

Motore overlord protection must be provided in accordance with National Electrical Code.

8.3 Control Circuit

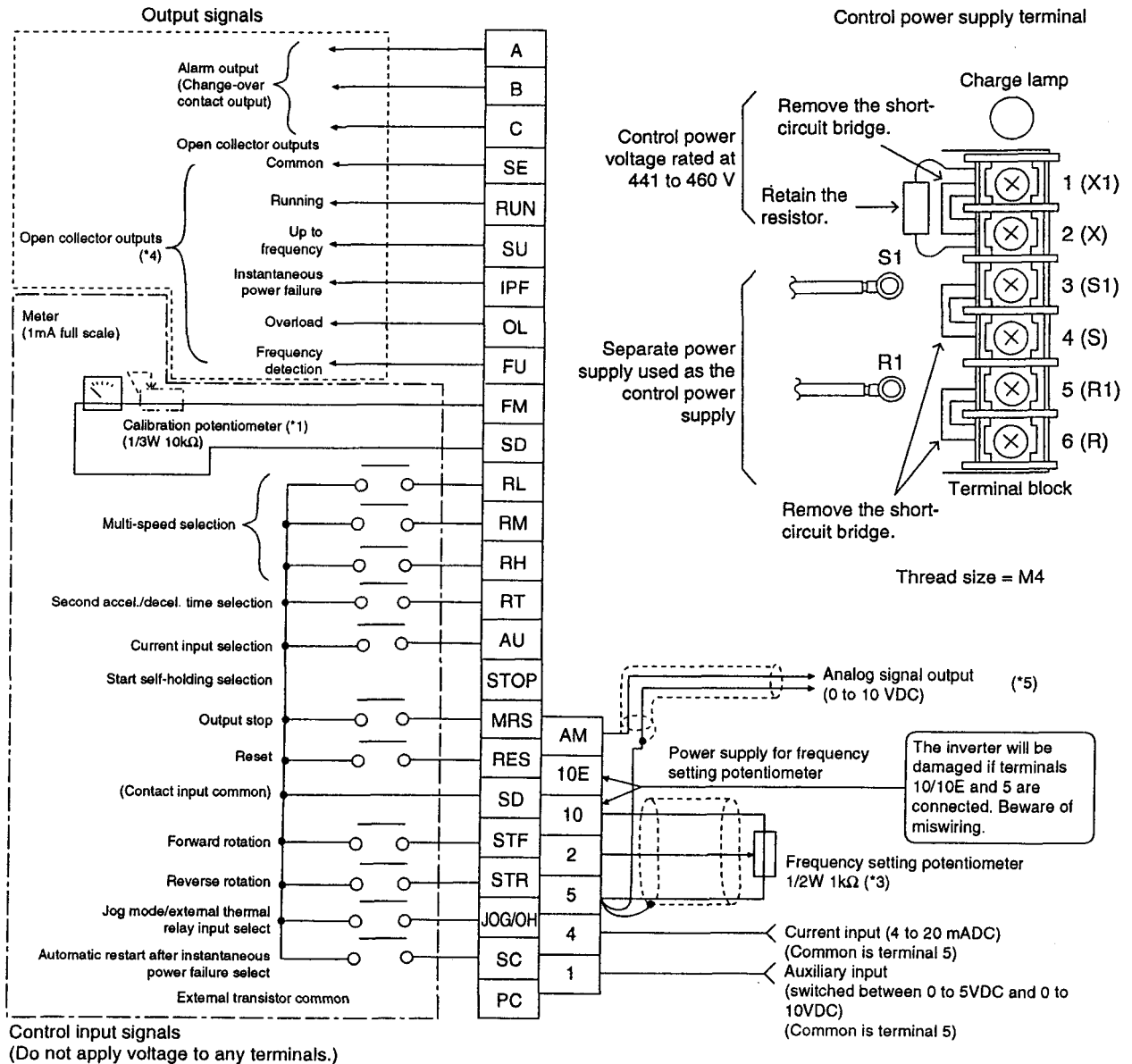

CAUTION

1. Terminals SD and 5, which are the common terminals of the I/O signals. Must not be grounded at the terminals.
2. Use shielded or twisted cables for connection to the control circuit terminals and run them away from the main and power circuits (including the 200V relay sequence circuit).
3. Since the frequency setting signals are micro currents, use two parallel micro signal contacts or a twin contact to prevent a contact fault.

(*1) 4. This calibration potentiometer is not required when making calibration from the parameter unit.

(*2) 5. Input signal switching can be done from the parameter unit.

(*3) 6. 2W 1K is recommended when the frequency setting is changed frequently.

(*4) 7. The output terminals other than the running (RUN) terminal allow alarm definition to be output in alarm codes and nine functions to be assigned individually.

- **Using the STOP terminal**

Connect as shown below to self-hold the start signal (forward rotation, reverse rotation).

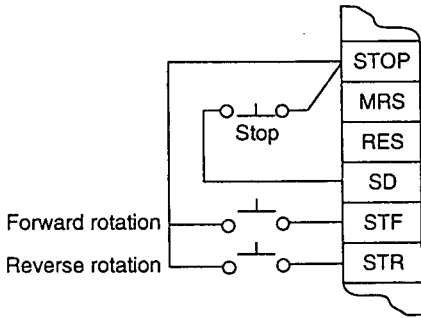

- **Using the CS terminal**

Used to perform automatic restart after instantaneous power failure and switch-over between commercial power supply and inverter.

Example: Automatic restart after instantaneous power failure

- (1) Connect CS and SD.
- (2) Set 0 in parameter 57.

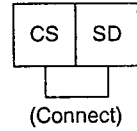

- **Using the PC terminal**

Used to connect transistor output (open collector output) such as a programmable logic controller (PC). Connecting the external power supply common for transistor output to the PC terminal prevents a faulty operation caused by a sneak current.

Note: AY40 requires DC24V power supply

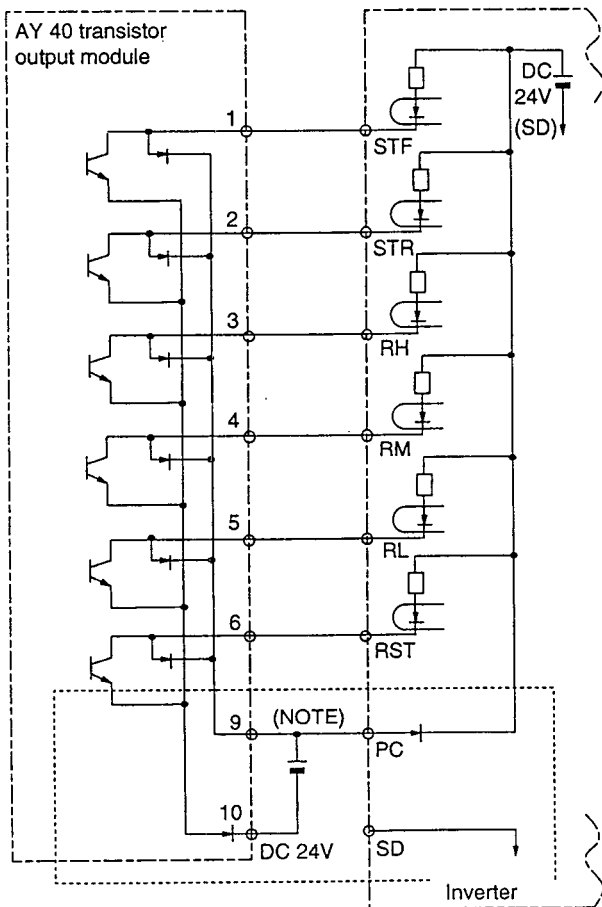

Correct Connection

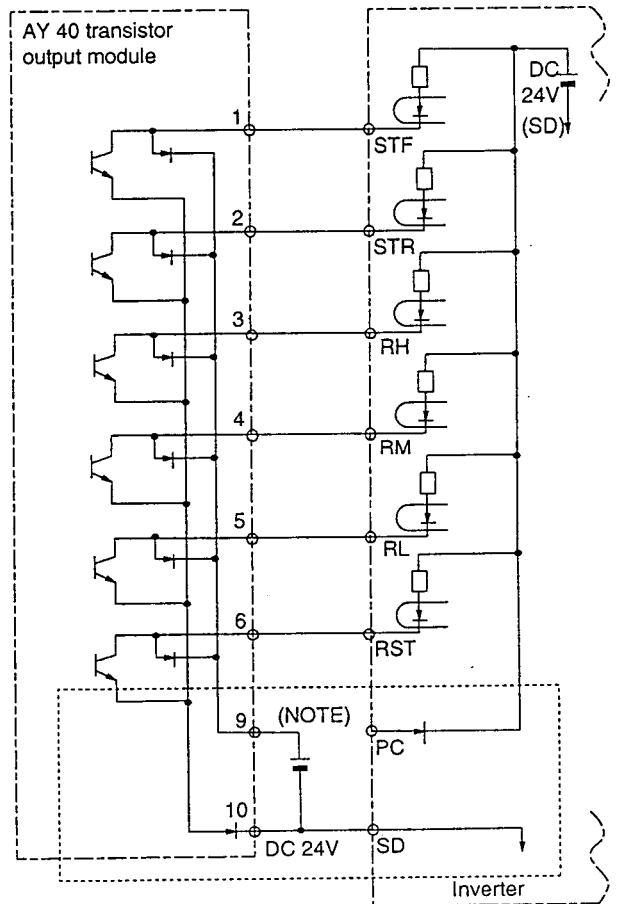

Wrong Connection

9. OPERATION

9.1 Operation Mode

Select any of the following operation modes according to the application and operating specifications:

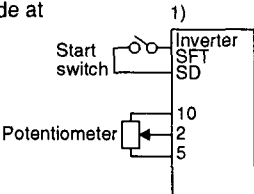
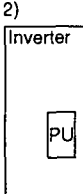
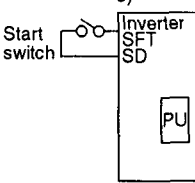
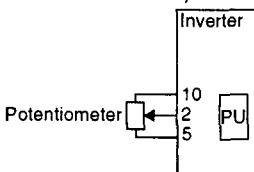
| Operation Mode | Description | Remarks |
|--|---|--|
| Operation using the external input signals | The inverter is operated with the start switch, frequency setting potentiometer, etc. connected to the control terminals of the inverter. | Factory-set to select this operation mode at power on.*  |
| Operation using the parameter unit | The inverter is started, set in frequency, and operated at variable speed from the parameter unit. | Prepare the parameter unit if it is not provided for the inverter. (See page 17 for the operating procedure.)  |
| Combined operation using the external input signals and parameter unit | Start is made by the external input signal, and the running frequency is set from the parameter unit. | The external frequency setting potentiometer and the forward rotation, reverse rotation and stop keys of the parameter unit are invalid.  |
| | The running frequency is set by the external input signal, and start and stop are effected from the parameter unit. | The external input signal start switch is invalid.  |

*Parameter unit operation mode may be selected at power on.

9.2 Pre-Operation Checks

After the installation and wiring procedures are complete, make the following checks before starting operation:

- (1) Check that the wiring is correct. Especially check that the power supply is not connected to terminals U, V and W.
- (2) Check that there are no faults such as short circuit due to wire off-cuts, etc.
- (3) Check that the screws, terminals, etc. are securely tightened.
- (4) Check that the motor and inverter are grounded.

Insulation resistance test using megger

- Perform the insulation resistance test using a megger in accordance with the procedure on page 74.
- Do not conduct the insulation resistance test on the inverter terminals and control circuit terminals.

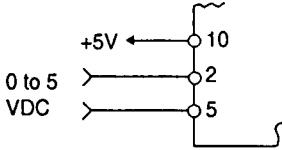
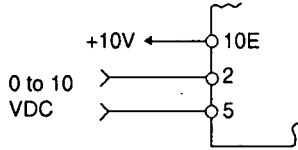
| Item | Description | Ref. Page |
|--|---|-----------|
| <p>Frequency setting input signal setting (for operation with analog signal)</p> | <p>Set the specifications of the frequency setting voltage signal entered across terminals 2-5.</p> <ul style="list-style-type: none"> • Operation at 0 to 5VDC Set 1 in function number 73. • Operation at 0 to 10VDC Set 0 in function number 73. <div style="display: flex; justify-content: space-around; align-items: center;"> <div style="text-align: center;">  </div> <div style="text-align: center;">  </div> </div> <ul style="list-style-type: none"> • Operation at 4 to 20mADC 4 to 20mADC input is only selected when terminals AU-SD are connected. Hence, AU and SD must be connected to perform operation with this signal. | p.61 |
| <p>Maximum frequency Minimum frequency</p> | <p><u>To be only used to restrict the upper and lower limits of the output frequency.</u> Through setting may be made at less than the maximum output frequency, proper operation cannot be performed if it is set to an unreasonable value.</p> | p.49 |
| <p>Meter calibration</p> | <p>Allows the meter to be calibrated from the parameter unit without using the calibration resistor.</p> | p.43 |

9.4 Check Points during Test Run

After checking that the inverter start signal is off (in the external signal operation mode), switch on the no-fuse breaker (NFB) and magnetic contactor (MC) in the inverter input circuit.

Perform a test run and check the operating status in the following procedure:

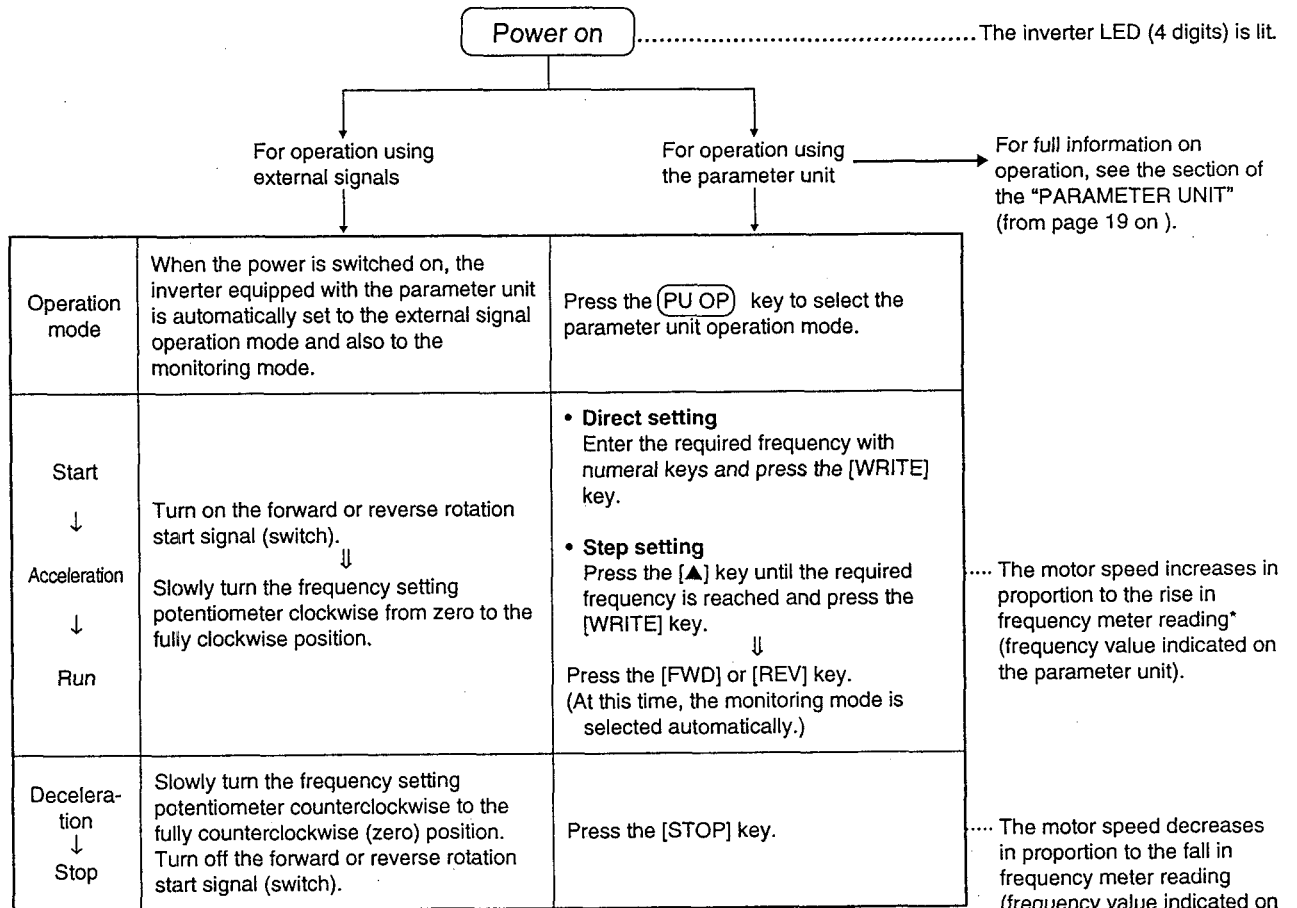

*Note: If the parameter unit is not in the monitoring mode, a frequency increase or decrease is not displayed.

Check Points

- (1) Check that the direction of motor rotation is correct. (See page 11 for the wiring and rotation direction.)
- (2) Check that the motor is free from unusual noise or vibration.
- (3) Check that the frequency meter deflects smoothly.
- (4) Check that the "OL" code is not displayed on the parameter unit during acceleration or deceleration. If the "OL" code is displayed:
 - Check that the load is not too large.
 - Increase the acceleration/deceleration time.
 - Reduce the boost value.

Note

- (1) The inverter is not started up if the forward rotation (STF) and reverse rotation (STR) start signals are turned on at the same time.
The motor is decelerated to a stop if the above signals are switched on at the same time during operation.
- (2) When ALARM is displayed on the inverter LED and the motor is coasted to a stop, make sure that the motor has stopped, then reset the inverter by switching the power off or using the reset terminal.

10. PARAMETER UNIT

10.1 Structure of the Parameter Unit (Option)

The FR-PU02E parameter unit is installed to the MT-A series inverter or connected to it by a cable (option) and allows operation to be performed, functions to be selected (set values to be read/written), the operating status to be monitored, and alarm definition to be displayed. In addition, the FR-PU02E has a troubleshooting function, help function and parameter graphic display function.

The FR-PU02E parameter unit is hereinafter referred to as the PU.

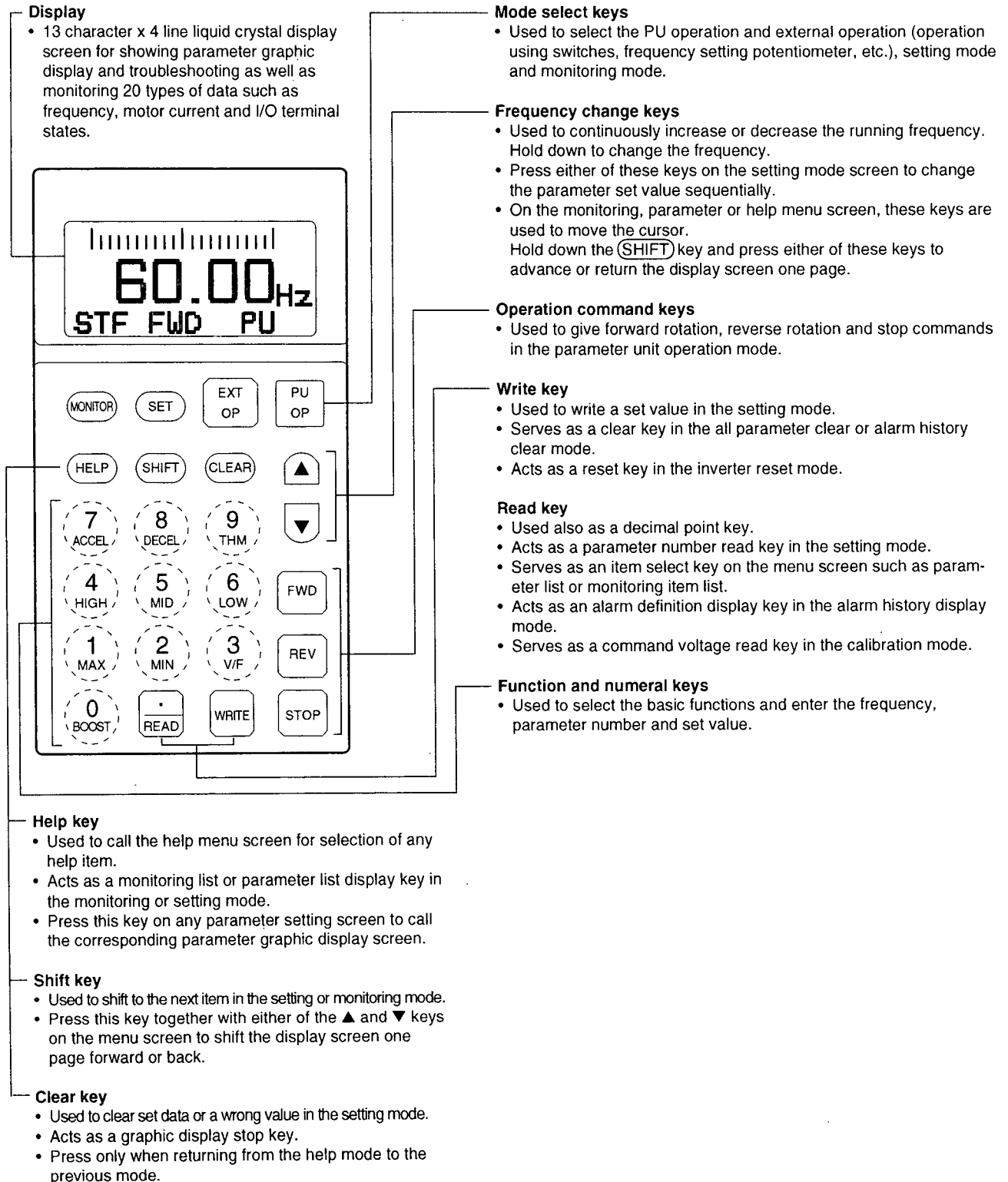

10.2 Functions of the Parameter Unit

The PU may be used in a wide variety of applications ranging from motor operation to monitoring as described below:

Note: A parameter will be referred to as Pr.

| | |
|--|---|
| <p>Selecting the operation mode</p> | <p>External operation and/or PU operation mode can be selected.</p> <p>External operation The inverter is operated using the start switch and frequency setting potentiometer connected to the inverter terminal block.</p> <p>PU operation The inverter is started/stopped and running frequency is set from the PU keys.</p> <p>PU/external combined operation The inverter is operated using the PU and external switch and potentiometer.</p> <p>The combined operation may be performed in either of the following methods:</p> <ol style="list-style-type: none"> 1) The PU keys are used for start and stop, and the external potentiometer is used for frequency setting. 2) The external switches are used for start and stop, and the PU keys used for frequency setting. |
| <p>Operating the motor</p> | <p>The frequency may either be entered directly from the ten-key pad or by holding down the [▲] (or [▼]) key.</p> |
| <p>Changing the function set value</p> | <p>The required function can be read directly or rewritten.....p.30</p> <p>Convenient functions</p> <ul style="list-style-type: none"> • All set value clear (initialization) p.36 • Rewrite disable p.62 • Frequency meter calibration p.43 • Reset selection p.61 |
| <p>Monitoring</p> | <p>The operating status (e. g. output frequency, motor current, input power) can be checked, and I/O terminal states and up to eight past alarm definitions can be monitored. The inverter is monitored by either the inverter LED display, PU main display or PU level display.</p> |

10.2.1 Operation Mode

The inverter has four operation modes; operation by external input signals, operation by PU, PU/external input signal combined operation and programmed operation. The operation mode can be selected (switched) between the external input signal operation mode and PU operation mode by the mode select keys of the PU. The other modes are selected by setting in Pr. 79. Pr. 79 also allows the operation mode to be limited (fixed). The PU operation mode may be output as a signal (see Pr. 40).

Factory-Set Operation Mode

When the input power is switched on (or reset is made), the operation mode is set to the external input signal operation mode. Hence, powering the inverter up makes it ready to operate with external input signals. In this state, turn on the start signal (across STF/STR-SD) to start operation.

Limiting (Fixing) the Operation Mode

The operation mode at power on may be limited, e.g. operation from the PU is enabled at power on without switching the operation mode with the PU's mode select key. For full information on setting the operation mode, see page 69.

Selecting the Operation Mode in the Factory-Set State (Pr. 79 setting is 0)

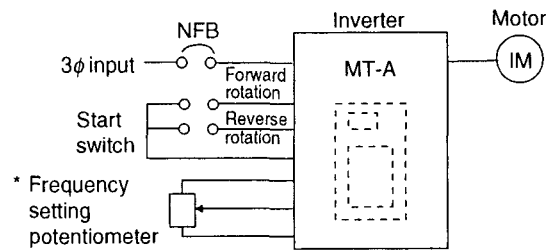
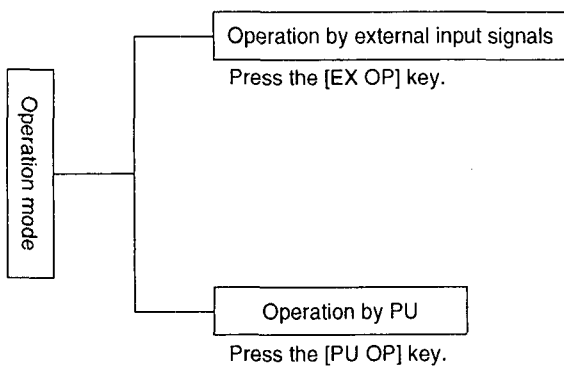

* The inverter is inoperative if the frequency setting potentiometer (setting signal) is not connected (input).

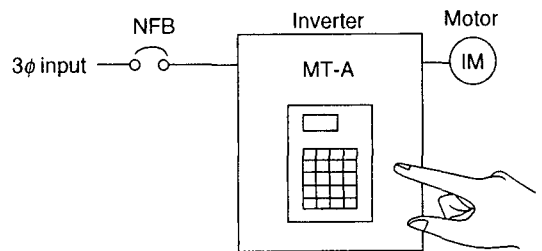

[CAUTION]

Switching between the PU operation and external signal operation must be performed after the forward (or reverse) rotation signal of the PU or external input signal has been turned off.

This switching cannot be performed if this signal is on.

10.2.2 Operation

The motor can be started and stopped from the PU without using the external frequency setting potentiometer or start switch.

The PU also allows jog operation.

Operating Procedure



(1) Directly entering (setting) the required frequency (Direct setting)

[PU OP] [Required frequency value] [WRITE] [FWD] (or [REV]) [STOP]

Setting the running frequency Repeating this procedure during operation allows the speed to be varied.

Setting example To run the motor in the forward direction at 30Hz.

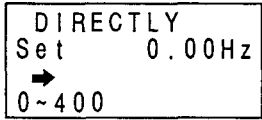
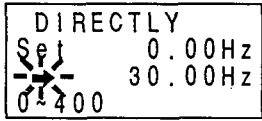
Note: The parameters, etc. are as factory-set.

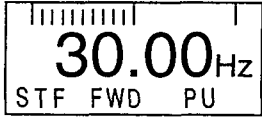
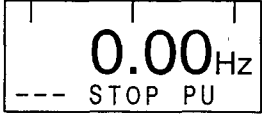
| Operation and keying Procedure | PU Screen Display | Remarks |
|--------------------------------|--|--|
| Power on |  <p>(1)</p> | |
| [PU OP] |  <p>(2)</p> | ← Displays the latest (previous) set value. (0Hz in the factory set state) |
| ③ ① |  <p>(3)</p> | |
| [WRITE] |  <p>(4)</p> | |
| [FWD] |  <p>(5)</p> | The motor starts. (900r/min for the 4-pole motor) |
| [STOP] |  <p>(6)</p> | The motor stops. |

(2) Directly entering (setting) the required frequency (Direct setting)

[PU OP] [Required frequency value] [WRITE] [FWD] (or [REV]) [STOP]

Setting the running frequency Repeating this procedure during operation allows the speed to be varied.

Setting example

After running the motor at 30Hz again as set on the preceding page, change the set value to 60Hz

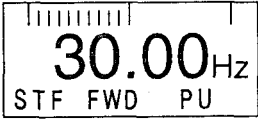
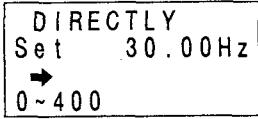
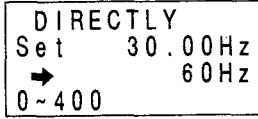
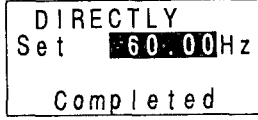
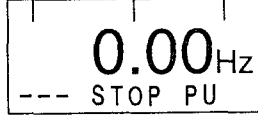
| Operation and keying Procedure | PU Screen Display | Remarks |
|--------------------------------|--|---|
| |  (7) | |
| [FWD] |  (8) | The motor runs at the preceding set value. |
| [PU OP] |  (9) | |
| ⑥ ① |  (10) | |
| [WRITE] |  (11) | The motor speed changes. (1800r/min for the 4-pole motor) |
| [STOP] |  (12) | The motor stops. |

**(3) Setting the required frequency by continuous speed change using the [▲] or [▼] key
(Step setting)**

[PU OP] [▲] (or [▼]) [WRITE] [FWD] (or [REV]) [STOP]

Setting example Change the preceding setting (60Hz) to 40Hz and run the motor in the forward direction.

| Operation and keying Procedure | PU Screen Display | Remarks |
|--------------------------------|-------------------|---|
| [PU OP] | <p>(14)</p> | The previous set value is displayed |
| [▼] ^{Note 1:} | <p>(15)</p> | This value changes (reduces) continuously while the [▼] key is pressed. |
| | <p>(16)</p> | |
| [FWD] | <p>(17)</p> | The motor starts. (1200r/min for the 4-pole motor) |
| [STOP] | <p>(18)</p> | The motor stops. |
| [WRITE] ^{Note 2:} | <p>(19)</p> | The set value is stored into the inverter memory. (Valid any time after the [▲] or [▼] key is pressed.) |

Note 1: Holding down the [▲] or [▼] key gradually increases the rate of change of the set frequency. Set to the target value by pressing and releasing the key as required.

Note 2: When the frequency has been set to the required value, the [WRITE] key must be pressed to store the set frequency. (When the power is switched off or when the PU operation mode is switched to the external operation mode and then switched back, the frequency returns to the set value as it had been before the change (60Hz in this example).)

(4) Jog operation

[PU OP] [SHIFT] [FWD] (or [REV])

Hold down the [FWD] (or [REV]) key to operate, and release to stop.

The jog operation frequency is the value set in the parameter (Pr. 15).

Operation example

1) Perform jog operation in the forward direction at 5Hz.

(5Hz is the factory-set value in Pr. 15)

2) Change the jog operation frequency to 7Hz and perform jog operation.

| Operation and keying Procedure | PU Screen Display | Remarks |
|--------------------------------|-------------------|--|
| [PU OP] | <p>(20)</p> | The previous set value is displayed. |
| [SHIFT] | <p>(21)</p> | Factory-set value |
| [FWD] | <p>(22)</p> | The motor starts. (150r/min for the 4-pole motor) |
| – (release the key) | <p>(23)</p> | Monitoring screen display in the jog operation mode. |
| [PU OP] [SHIFT] | <p>(24)</p> | |
| ⑦ [WRITE] | <p>(25)</p> | The jog operation frequency is set to 7Hz. |
| [FWD] | <p>(26)</p> | The motor starts. (210r/min for the 4-pole motor) |
| – (release the key) | <p>(27)</p> | |
| [PU OP] | <p>(28)</p> | Returns to the normal PU operation mode. |

10. 2.3 Changing the Monitor Screen

The inverter can be monitored by either the LED (red light emitting diode) display on the inverter, the 5-digit liquid crystal display on the PU (PU main monitor) or the PU level meter. These displays are selected by the following method:

1. Inverter LED display

Setting Pr. 51 on the PU allows selection from 16 types of data.

For full information on the setting method, see the explanation of Pr. 51.

Pr. 51 is factory-set to the output frequency display (Pr. 51 =1).

2. PU level meter

Setting Pr. 53 on the PU allows selection from 15 types of data.

For full information on the setting method, see the explanation of Pr. 53.

Pr. 53 is factory-set to the output frequency display (Pr. 53 =1).

3. PU main monitor

- 5 types of data can be selected in sequence by the SHIFT key as shown below.
- Among the five monitor screens, the fifth monitor screen (selective monitoring) allows selection from 12 types of data such as the frequency set value and running speed.
- Additionally, Pr. 52 allows selection from four types of data such as the load meter and cumulative operation time.
- For full information on the select items, see the explanation of Pr. 52.

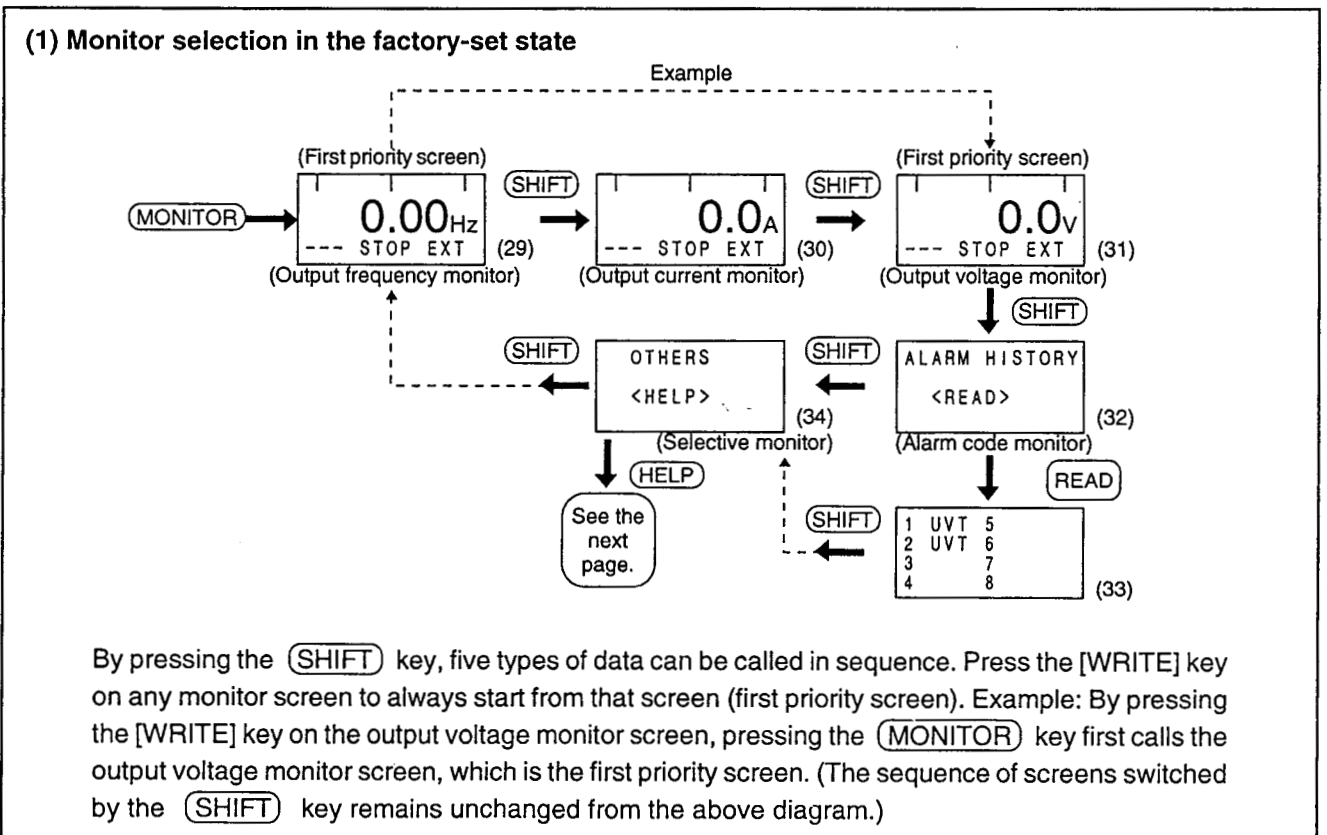

(2) Selecting a new monitor item in the selective monitoring mode

OTHERS
<HELP> (35)

(HELP) [▼] [READ] [WRITE]

Monitor select screen (for the way of calling this screen, refer to the preceding page)

★ For the items selectable, see page 56.

Setting example Select the input terminal state screen in the selective monitoring mode.

| Operation and keying Procedure | PU Screen Display | Remarks |
|--|-------------------|--|
| [PU OP] | <p>(36)</p> | The following operation can also be carried out in the external operation mode. |
| (MONITOR) | <p>(37)</p> | |
| (SHIFT) (SHIFT) (SHIFT) (SHIFT) | <p>(38)</p> | Hold down (SHIFT) and press [▼] or [▲] to advance or return the screen one page. |
| (HELP) | <p>(39)</p> | |
| Hold down (SHIFT) [▼][▼][▼] Without pressing (SHIFT) Key [▼][▼] | <p>(40)</p> | |
| [READ] [WRITE] | <p>(41)</p> | |
| | <p>(42)</p> | By pressing the (SHIFT) key, the other monitor screens can be called. |

Note 1: In this state, the I/O terminal states selected here are first displayed with priority when the other operation mode is switched to the monitoring mode. (Refer to the preceding page.) When first priority has been given to other data, press the [WRITE] key with that monitor screen being displayed. The first priority screen then switches to that monitor screen.

Note 2: When the selective monitor screen is not the first priority screen as in the above operation, the selected data is erased from the memory as soon as the power is shut off or the other operation mode (such as external operation) is selected.

In this case, the selective monitoring mode must be selected again by the above procedure.

When the selective monitor screen remains as the first priority screen, the selected data remains intact in the memory.

(3) Selecting any of the monitoring items “load meter”, “motor exciting current”, “position pulse”, and “cumulative operation time”

When the “load meter” or “motor exciting current” has been selected, the output current monitor screen is switched to a corresponding screen.

When the “position pulse” or “cumulative operation time” has been selected, the output voltage monitor screen is switched to a corresponding screen. When any of these four items has been selected, therefore, the output current or output voltage monitor screen cannot be used.

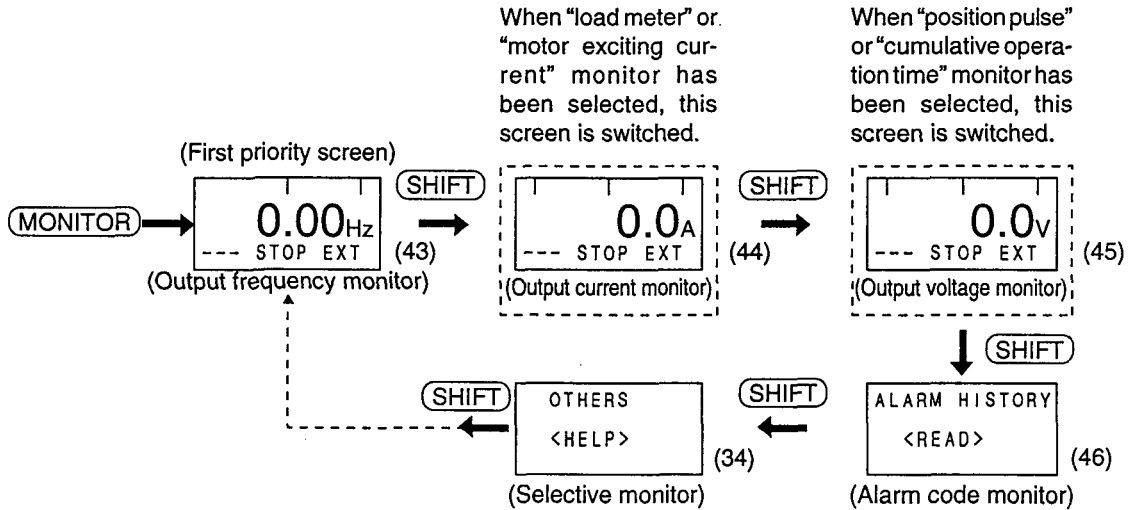

Screen Display in the Frequency Monitoring Mode

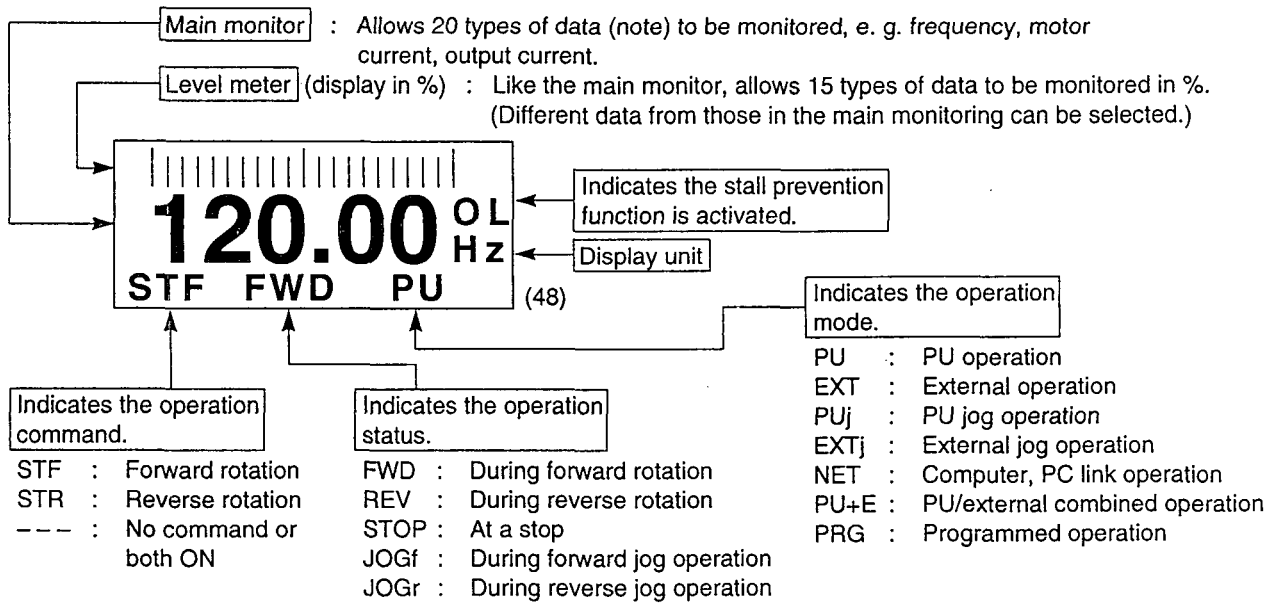

Note: For more information on the 20 monitor screens available, refer to page 59 (monitor/output signal selection).

- The following modes are displayed on the parameter unit:

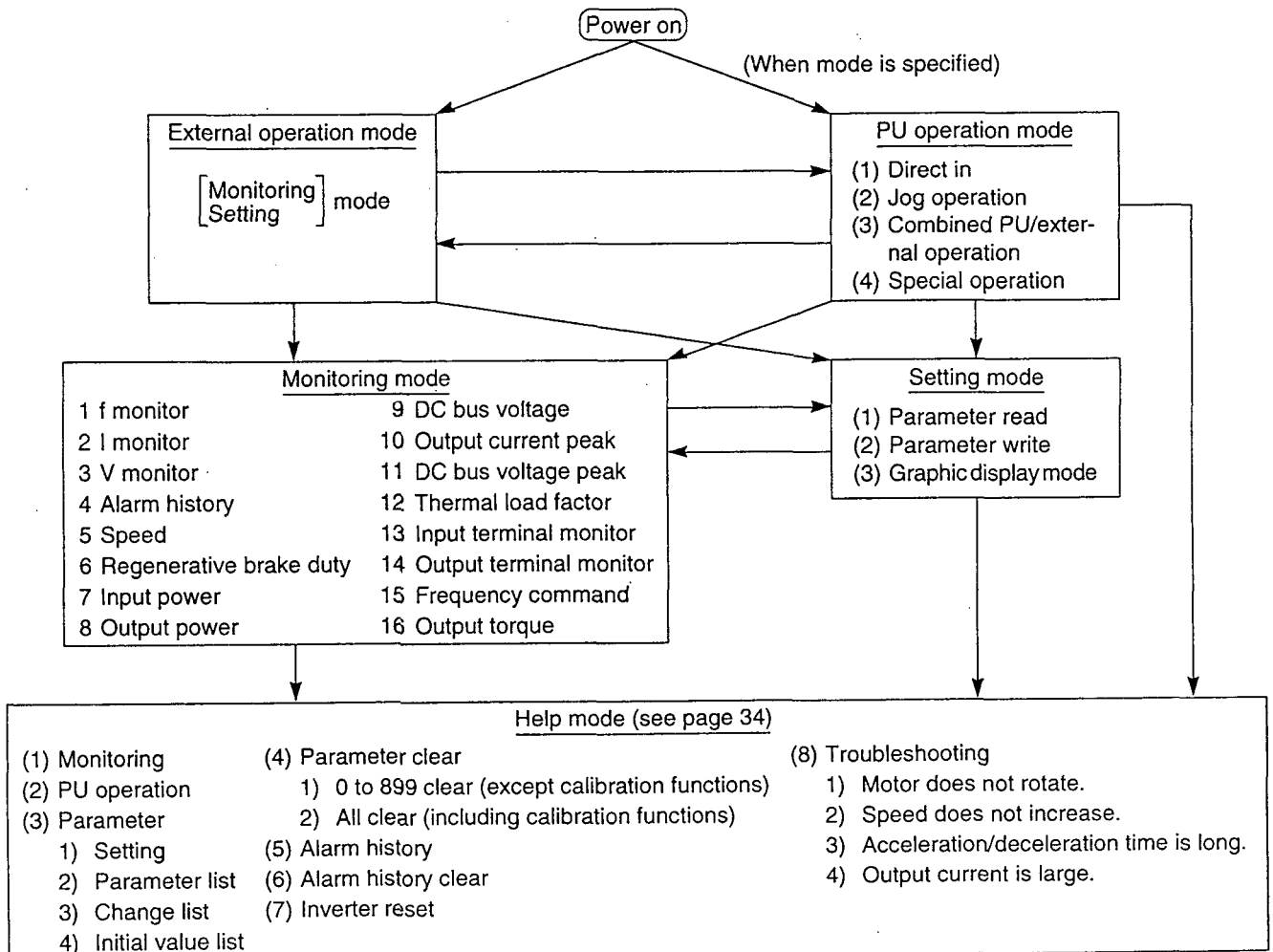

10. 2.4 Changing or Checking the Function (Parameter) Set Values

By changing the parameters of the inverter, the function and performance of the inverter and motor can be matched to the application. The factory-set values need not be changed when they are appropriate. The parameter numbers are represented Pr.

Operating Procedures

(1) Directly entering the Pr. number, calling and setting the parameter

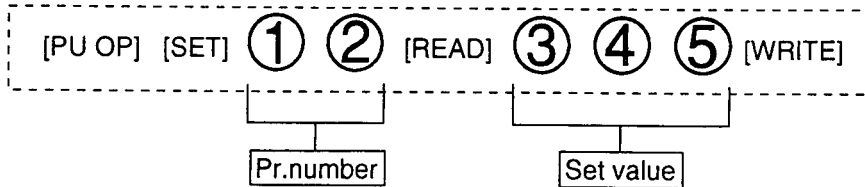

* The function names (abbreviation) of parameters Pr. 0 to Pr. 9, which are most often used, are given below the numerals on the numeral keys (0 to 9).

Setting example Setting Pr. 7 (acceleration time) to 3.5 seconds.

| Operation and Keying Procedure | PU Screen Display | Remarks |
|--------------------------------|-------------------|---|
| [PU OP] [SET] | (49) | |
| ⑦ | (50) | |
| [READ] | (51) | Current set value Setting range To call the parameter function graphically |
| * ③ [READ] ⑤ [WRITE] | (52) | (55) |
| [MONITOR] | (53) | Press the [MONITOR] key to move to the [MONITOR] screen. |
| or [SHIFT] | (54) | After the setting is complete, press the [SHIFT] key to move to the next parameter. |

(2) Calling the parameter list and setting the parameter

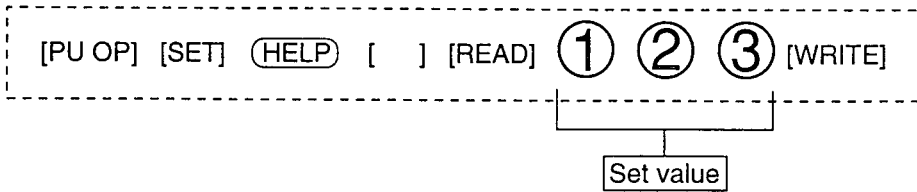

Setting example Setting Pr. 13 (starting frequency) to 1Hz.

| Operation and Keying Procedure | PU Screen Display | Remarks |
|--------------------------------|-------------------|--|
| [PU OP] [SET] [READ] | <p>(56)</p> | |
| [HELP] | <p>(57)</p> | |
| Note [SHIFT] [▼] [▼] [▼] | <p>(58)</p> | |
| [READ] | <p>(59)</p> | To call the parameter function graphically <p>(63)</p> (Returns to the previous screen) |
| ① [WRITE] | <p>(60)</p> | |
| [MONITOR] | <p>(61)</p> | |
| or [SHIFT] | <p>(62)</p> | After the setting is complete, press the [SHIFT] key to move to the next parameter. |

Note: Hold down the [SHIFT] key and press the [▼] key.

10. 2.5. Applying the Help Function

By pressing HELP in any PU operation mode, the inverter gives the operation guide.

- | | | | | |
|-----|-----------------------------|--------|--------|---------------------------|
| (1) | Monitoring mode | (HELP) | → | Monitoring (item) list |
| (2) | Setting mode | (HELP) | → | Parameter (item) list |
| | (before Pr. number setting) | | | |
| (3) | Setting mode | (HELP) | → | Graphic display |
| | (after Pr. number setting) | | | |
| (4) | PU operation mode | (HELP) | → | Key operation explanation |
| (5) | General operation mode | (HELP) | (HELP) | → Help (item) list |

(1) Help function in the monitoring mode

| Operating and Keying Procedure | PU Screen Display | Remarks |
|---|--|---|
| <p>(PU OP) (MONITOR)</p> <p>(HELP)</p> | <div style="border: 1px solid black; padding: 5px; text-align: center; margin-bottom: 10px;"> </div> <div style="border: 1px solid black; padding: 5px; text-align: center;"> </div> | <p>This operation may be performed on any monitor screen. Also this operation may be performed during inverter operation.</p> |

- ★ Move the cursor (indicated by →) using the [▲] (or [▼]) key, then press the [READ] Key to select the corresponding monitor item.
- ★ Furthermore, press the [WRITE] key to store the data so that this screen is displayed first in the monitoring mode after the monitor screen has been switched to another display screen.

(2) Help function in the setting mode (Part 1)

| Operating and Keying Procedure | PU Screen Display | Remarks |
|--------------------------------|--|---------|
| (PU OP) (SET) | <pre> SETTING MODE Set Pr.NO. FOR Pr.List <HELP> (66) </pre> | |
| (HELP) | <pre> 0 Trq.Bst1 1 Max.F1 2 Min.F1 3 VFbaseF1 (67) </pre> | |

Move the cursor (→) and press the [READ] key to select any parameter.

(3) Help function in the setting mode (Part 2) Operation example Pr. 0 (torque boost)

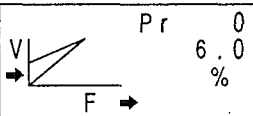
| Operating and Keying Procedure | PU Screen Display | Remarks |
|--------------------------------|--|---|
| (PU OP) (SET) | <pre> SETTING MODE Set Pr.NO. FOR Pr.List <HELP> (68) </pre> | |
| 0 (READ) | <pre> 0 Trq.Bst1 6.0% → 0~30 (69) </pre> | |
| (HELP) |  <pre> Pr 0 6.0 % (70) </pre> | The function of the corresponding parameter is displayed graphically. |

★ On this screen, press the SHIFT key to graphically display the parameter of the next number.

(4) Help function in the PU operation mode (before frequency setting)

| Operating and Keying Procedure | PU Screen Display | Remarks |
|--------------------------------|--|---|
| (PU OP) | <pre> DIRECTLY Set 50.00Hz → 0~400 (71) </pre> | |
| (HELP) | <pre> KEY OPERATION Fset: 0-9 Then: WRITE Then: FWD, REV (72) </pre> | <p>Key operation explanation screen</p> <ul style="list-style-type: none"> ● To set the frequency (f), use the 0 to 9 numeral keys. ● Then press the [WRITE] key. ● Furthermore press the [FWD] or [REV] key to start. |

(5) Calling the help menu

Press the **HELP** key twice in any operation mode to call the help menu, with which various functions can be executed.

Help Menu

| Function Name | Description |
|------------------------|---|
| 1. MONITOR | Displays the monitoring list (items). |
| 2. PU OPERATION | Informs how to perform PU operation and PU-assisted jog operation via direct input (direct setting from the ten-key pad). |
| 3. PARAMETER | Allows any of the following item executing methods to be selected: 1) Parameter setting 2) Parameter list calling 3) Parameter change list (list of parameters which have been changed from the factory-set values) 4) Initial value list (list of parameters set at the factory) |
| 4. PARAMETER CLEAR | Either of the following two items can be selected: 1) Parameter clear (returns all parameters to the factory-set values with the exception of calibration parameters Pr. 900 to 905) 2) All parameter clear (returns all parameters to the factory-set values) |
| 5. ALARM HISTORY | Displays past eight alarms. |
| 6. ALARM HISTORY CLEAR | Clears the above alarms. |
| 7. INVERTER RESET | Resets the inverter. |
| 8. TROUBLESHOOTING | The inverter displays the most likely cause of mismatch in inverter operation with operation/setting or the cause of inverter fault. |

Operations in the help menu not previously described will now be described.

(5) -1) Parameter change list

Displays only the set values of the parameters which have been changed from the factory-set values.

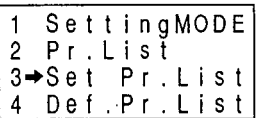
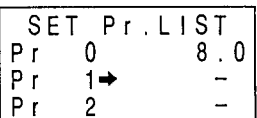
| Operating and Keying Procedure | PU Screen Display | Remarks |
|--------------------------------|--|---|
| (PU OP) (HELP) (HELP) |  (73) | Help menu screen |
| [▼][▼][READ] |  (74) | Help menu screen regarding the parameters |
| [▼][▼][READ] |  (75) | Only the parameters which have been changed in setting are displayed on part of the screen. (The screen shown on the left indicates an example of Pr. 0 whose value has been changed to 8%.) |



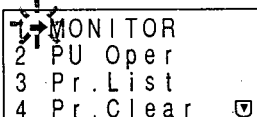
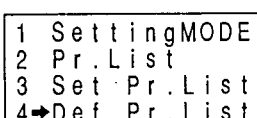
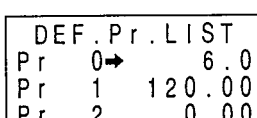
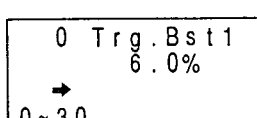

(5) -2) Initial value list

Displays a list of the factory-set values of the parameters. This function is convenient when a typical set value is lost.

| Operating and Keying Procedure | PU Screen Display | Remarks |
|--------------------------------|--|--|
| (PU OP) (HELP) (HELP) |  (76) | |
| [▼][▼][READ] |  (77) | |
| [▼][▼][▼][READ] |  (78) | |
| [READ] |  (79) | Enters the setting mode of the parameter at the cursor position. |

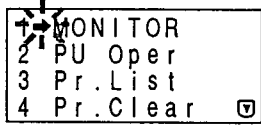
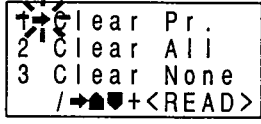
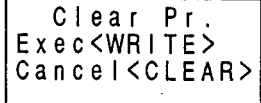
(5) -3) Parameter clear and all parameter clear

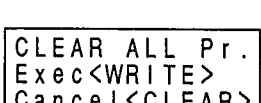
Parameter clear and all parameter clear differ as follows: The parameter clear operation does not clear the calibration parameters of Pr. 900 to Pr. 905, but the all parameter clear operation clears all parameters. Clear indicates that the parameters are set to the factory-set values.

| Operating and Keying Procedure | PU Screen Display | Remarks |
|--------------------------------|---|---|
| <p>(PU OP) (HELP) (HELP)</p> |  <p>(80)</p> | |
| <p>[▼] [▼] [▼] [READ]</p> |  <p>(81)</p> | |
| <p>[READ]</p> |  <p>(82)</p> | |
| <p>[WRITE]</p> |  <p>(83)</p> | <p>Press the [PU OP], [CLEAR] or other key to return to another mode.</p> |
| <p>[▼] [READ]</p> |  <p>(84)</p> | |
| <p>[WRITE]</p> |  <p>(85)</p> | <p>Press the [PU OP], [CLEAR] or other key to return to another mode.</p> |

(5) -4) Alarm history and alarm history clear

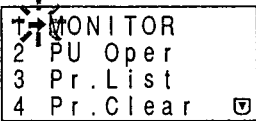
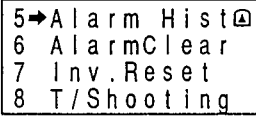
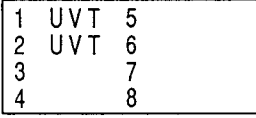
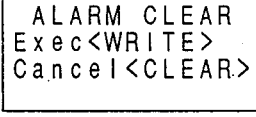
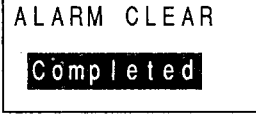
| Operating and Keying Procedure | PU Screen Display | Remarks |
|--|--|--|
| <p>(PU OP) (HELP) (HELP)</p> |  (86) | |
| <p>Hold down (SHIFT) and press [▼]</p> |  (87) | |
| <p>[READ]</p> |  (88) | * Alarm history screen |
| <p>[▼] [READ]</p> |  (89) | |
| <p>[WRITE]</p> |  (90) | Press the [PU OP], or [SHIFT] key to return to another mode. |

* The alarm history can also be displayed by pressing the SHIFT key in the monitoring mode.
(See page 26)

(5) -5) Inverter reset

If any protective function of the inverter has tripped the inverter, the following operation allows the inverter to be reset via the keypad.

The inverter can also be reset by switching the power off or connecting the terminals RES-SD.

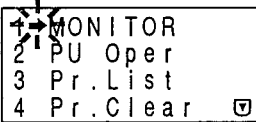
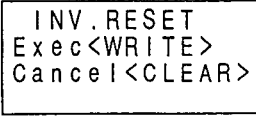
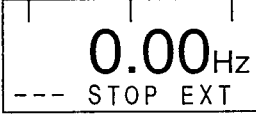
| Operating and Keying Procedure | PU Screen Display | Remarks |
|---|--|--|
| <p>(PU OP) (HELP) (HELP)</p> |  (91) | |
| <p>Hold down [SHIFT] and press [▼] further [▼] [▼] [READ]</p> |  (92) | |
| <p>[WRITE]</p> |  (93) | When another monitor item has been selected on the monitoring first-priority screen, that monitor screen is displayed. |

10.2.6 Troubleshooting

Select this mode when the inverter operation appears faulty. The most likely cause of the fault is displayed. This operation mode can be selected during the inverter operation (PU operation, external operation), alarm trip (protection activated), etc.

| Operating and Keying Procedure | PU Screen Display | Remarks |
|---|---|---|
| <p>(HELP) (HELP)</p> <p>Hold down (SHIFT) and press [▼] further [▼][▼][▼]</p> <p>(READ)</p> | <div style="border: 1px solid black; padding: 5px; margin-bottom: 5px;"> <p>MONITOR</p> <p>2 PU Oper</p> <p>3 Pr. List</p> <p>4 Pr. Clear (94)</p> </div> <div style="border: 1px solid black; padding: 5px; margin-bottom: 5px;"> <p>5 Alarm Hist (95)</p> <p>6 Alarm Clear</p> <p>7 Inv. Reset</p> <p>8 T/Shooting</p> </div> <div style="border: 1px solid black; padding: 5px;"> <p>1 M. Not Run</p> <p>2 M. Spd Error</p> <p>3 M. A/Dec Err</p> <p>4 M. Curr. High (96)</p> </div> | <p>Symptom menu. Move the cursor to the item matching the fault and press the (READ) key.</p> |

The fault on each display screen are described below.

■ M. NOT RUNNING (Motor does not rotate)

M. NOT RUNNING
ALARM
Indicated
<SHIFT>

(97)

The inverter has alarm-tripped (protection activated), resulting in output shut-off. Press the [SHIFT] key to display the cause of protection activated.

M. NOT RUNNING
NO I/P Power
or Phase Loss

(98)

The main circuit power of the inverter is lost, or open phase has occurred in the power supply. Check the power supply.

M. NOT RUNNING
STF, STR
both are OFF
or ON

(99)

Both start signals STF and STR are ON or OFF.

M. NOT RUNNING
MRS is ON

(100)

The output shut-off input terminal MRS is ON.

M. NOT RUNNING
SetF < StartF
Pr. 13

(101)

The inverter starting frequency (Pr. 13) set value is higher than the current set frequency.

M.NOT RUNNING
AU is OFF

(102)

The current input select terminal AU remains OFF. (Not ON)

M.NOT RUNNING
NO Command
From PU

(103)

Neither of the FWD and REV keys are ON in the PU operation mode.

M.NOT RUNNING
Max.F1<StartF
Pr.1 Pr.13

(104)

The inverter cannot be started because the inverter starting frequency (Pr. 13) value is higher than the maximum frequency (Pr. 1).

M.NOT RUNNING
EnableFR Set
See Pr.78

(105)

The inverter cannot be started because the forward or reverse rotation has been inhibited by the value set in Pr. 78.

M.NOT RUNNING
Current Limit
Activated
<SHIFT>

(106)

The inverter cannot be started since the current limit function is operating. Press the SHIFT key to display the assumed cause of activating the current limit function.

M.NOT RUNNING
TS Control
Standby Mode

(107)

The inverter cannot be started because it is the stop period in the programmed operation mode.

M.NOT RUNNING
Under
PI Control

(108)

The inverter is not started because the operation of PI control has resulted in a condition under which the inverter need not be started.

M.NOT RUNNING
CS is OFF
See Pr.57

(109)

Restart cannot be made since the automatic restart after instantaneous power failure select terminal CS is OFF.

Currently it is assumed to be after instantaneous power failure or in the commercial power supply switch-over operation mode.

■ M.SPEED ERROR (Speed does not match the running frequency set value)

```
M. SPEED ERROR
SetF>MaxF1/F2
60.00 Pr1/18
Hz
```

(110)

Since the running frequency set value is higher than the maximum frequency (Pr. 1) set value, the running frequency remains at the maximum frequency.

```
M. SPEED ERROR
SetF<Min.F1
60.00 Pr.2
Hz
```

(111)

Since the running frequency set value is lower than the minimum frequency (Pr. 2) set value, the running frequency has been risen to the minimum frequency.

```
M. SPEED ERROR
Fjump Working
See Pr.31→36
SetF= 60.00Hz
```

(112)

Since the running frequency set value is within the frequency jump setting range, the running frequency has jumped.

```
M. SPEED ERROR
Current Limit
Activated
<SHIFT>
```

(113)

The current limit function has been activated and forced the running frequency to reduce. Press the SHIFT key to display the cause of activating the current limit function.

```
M. SPEED ERROR
Under
PI Control
```

(114)

The operation of PI control has caused the running frequency to be offset from the set value.

■ M.A/Dec Err

(Acceleration/deceleration time is longer than the value set in Pr.7/Pr.8)

```
Set 5.0S
0→ 60.00HZ
Set 5.0S
60.00HZ→0
```

(115)

Acceleration time set value (Pr.7) is displayed.

Frequency reached in the above set time (acceleration/deceleration reference frequency, Pr.20) is displayed.

Deceleration time set value (Pr.8) is displayed.

Frequency from which deceleration is made in the above set time (acceleration/deceleration reference frequency, Pr.20) is displayed.

```
Still Pv.ON? □
Set Too Low?
Load Too Big?
Pr.22 Error?
```

(116)

Assumed cause of longer acceleration/deceleration time than the set value is displayed.

- Stall prevention function (current limit function) is implemented.
- Set time is too short.
- Motor load is heavy.
- Pr. 22(stall prevention operation level) setting error.

■ M.Curr.High (Inverter output current value is larger than normal)

Inv. Output
60.00HZ
10A 230V
<SHIFT>

(117)

First, the running frequency, output current and output voltage of the inverter are displayed.

Press the **(SHIFT)** key to display the assumed cause of large output current.

(SHIFT)

Low Impedance
Motor?
Reduce TrgBst
Pr. 0, 38, 46

(118)

Is the motor a special motor other than the general-purpose 3-phase induction motor?

If so, reduce the torque boost set value.

Related parameters : Pr. 0, 38, 46



Low Trq
Motor?
Reduce TrgBst
Pr. 0, 38, 46

(119)

Is the motor a constant-torque motor (motor for inverter)?

If so, reduce the torque boost set value.

Related parameters : Pr. 0, 38, 46



Trq. Bst
Setting Err?
See Pr. 0, 38,
46

(120)

Since the torque boost set value may be inappropriate, check the following relevant parameters:

Related parameters : Pr. 0, 38, 46



V/F Setting
Error?
See Pr. 3, 14,
19, 47

(121)

Since the V/F pattern setting may be inappropriate, check the following relevant parameters:

Related parameters : Pr. 3, 14, 19, 47



Load Too Big?
Output
Phase Loss?

(122)

The load may be too heavy.

An open phase may have occurred between the inverter and motor.

■ If the fault could not be identified by the above operation.

Inv. Output
60.00HZ
10A 230V
<SHIFT>

(123)

If the cause of the fault could not be found in the inverter, the current running frequency, output current and output voltage are displayed on the screen.

Press **(SHIFT)** to display the relevant assumed cause.

10.2.7 Setting of special parameters

The MT-A Series inverter provides the parameters required to control the inverter of the large-capacity motor.

(1) Hold time for starting (Pr.65)

If GD2 is large when blower or large-inertia load is started, some time is required from the start at the start frequency to the stable operation. Since the acceleration (frequency rise) is started from the stable state, the start frequency is held for the time (0 to 10.0 seconds) set at Pr.65 soon after the start.

(2) Optimal V/F pattern setting (Pr.140)

On the fan, pump and other load in which the necessary load varies in proportion to the square of the revolution speed, it is thought to select the voltage which is lower than that for constant V/F, reduce the iron loss and increase the efficiency accordingly as the revolution speed drops.

(Effective for the motor of 8 or more poles.)

For this purpose, the parameter Pr.140 is used to optimize the V/F pattern. (Refer to P51.)

Sometimes effective for noise reduction.

(3) PWW mode change (Pr.72)

In order to reduce the keen noise offensive to the ear from the motor noise, set 1 at Pr.72.

In order to further reduce the noise at the low speed by the sine wave filter (optional), set 2 at Pr.72.

(When the sine wave filter is not provided, don't set 2 at Pr.72.)

10. 2.8 Calibrating the Frequency Meter

The PU allows the calibration (adjustment) of a meter connected across the meter connection terminal FM-SD or AM-5 of the inverter.

When a digital meter is used, the PU allows the frequency of the pulse train output signal to be adjusted (across terminals FM-SD).

(1) Calibration of the FM-SD output

- Preparation**
- (1) Connect a meter across inverter terminals FM-SD. (Note polarity. FM is the positive terminal.)
 - (2) When a calibration resistor has already been connected, adjust the resistance value to zero or remove the resistor.
 - (3) When 1 or 2 has been set in Pr. 54 to select the running frequency or inverter output current as the output signal, preset in Pr. 55 or Pr.56 the running frequency or current value at which the output signal is 1440Hz. This 1440Hz normally makes the meter full-scale.
- * The motor need not be connected.

Operating Procedure (The following example indicates that the meter is calibrated to the running frequency of 60Hz.)

| Operating and Keying Procedure | PU Screen Display | Remarks |
|--|-------------------|--|
| (PU OP) (SET) ⑨ ① ① (READ) | | ← The current PU set frequency is displayed. |
| Set the running frequency. ⑥ ① (WRITE) | | |
| (FWD) | | Forward operation is performed at 60Hz. |
| Adjust the frequency meter reading to a predetermined position using the [▲] or [▼] key. | | The frequency meter reading moves. |
| (WRITE) | | Calibration is complete. |
| (MONITOR) | | |

Note: This calibration (Pr. 900) is only valid when any of 1 to 3, 5 to 14, 17, 18 and 21 has been set in Pr. 54 to output a signal to terminal FM. When any other value has been set (signal output to terminal AM has been selected in Pr. 54), the absence of Pr. 900 is displayed on the screen as soon as this parameter is selected by the above operation.

(2) Calibration of the AM-5 output

- Preparation**
- (1) Connect a meter of 0-10VDC across inverter terminals AM-5. (Note the polarity. AM is the positive terminal.)
 - (2) When 101 or 102 has been set in Pr. 54 to select the running frequency or inverter output current as the output signal, preset in Pr. 55 or Pr. 56 the running frequency or current value at which the output signal is 10V.

Operating Procedure (The following example indicates that the meter is calibrated to the running frequency of 60Hz.)

| Operating and Keying Procedure | PU Screen Display | Remarks |
|---|---|---|
| <p>(PU OP) (SET) ⑨ ⑩ ① READ</p> | <pre>901 AM Tune Run Inverter Set → 0.00Hz PU (130)</pre> | <p>The current PU set frequency is displayed.</p> |
| <p>Set the running frequency. ⑥ ⑦ WRITE</p> | <pre>901 AM Tune Run Inverter Set 60.00Hz PU (131)</pre> | |
| <p>(FWD)</p> | <pre>901 AM Tune MntrF 60.00Hz →◀◀WRITE>PU (132)</pre> | <p>Forward operation is performed at 60Hz.</p> |
| <p>Adjust the frequency meter reading to a predetermined position using the [▲] or [▼] key.</p> | <pre>901 AM Tune MntrF 60.00Hz →◀◀WRITE>PU (133)</pre> | <p>The frequency meter reading moves.</p> |
| <p>(WRITE)</p> | <pre>901 AM Tune Completed <MONITOR> (134)</pre> | <p>Calibration is complete.</p> |
| <p>(MONITOR)</p> | <pre> 60.00Hz STF FWD PU (135)</pre> | |

Note: This calibration (Pr. 901) is only valid when any of 101 to 103, 105 to 114, 117, 118 and 121 has been set in Pr. 54 to output a signal to terminal AM. When any other value has been set (signal output to terminal FM has been selected in Pr. 54), the absence of Pr. 901 is displayed on the screen as soon as this parameter is selected by the above operation.

10. 2.9 Adjusting the Bias and Gain of the Frequency Setting Signal

The bias and gain functions are used to adjust the relationship between the input signal entered from outside the inverter to set the output frequency, e.g. 0 to 5VDC, 0 to 10VDC or 4 to 20mADC, and the output frequency. Parameters Pr. 902 to Pr. 905 are used for this adjustment.

Adjustment examples

- Frequency setting voltage bias setting
Set the output frequency to 10Hz at the set voltage of 0V.
- Frequency setting voltage gain setting
Set the output frequency to 60Hz at the set voltage of 5V.

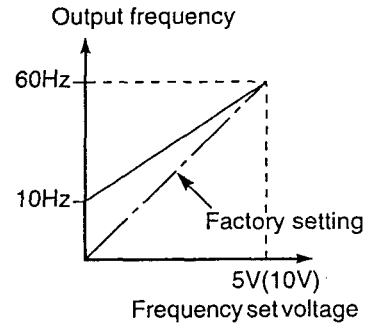

Preparation: Set 1 (factory-set value) in Pr. 73 to select input 0-5V for terminal 2.

| Operating and Keying Procedure | PU Screen Display | Remarks |
|---|---|---|
| <p>(PU OP) (SET)</p> <p>⑨ ① ② (READ) (note)</p> <p>① ① (WRITE)</p> | <pre>902 EXTvbias → 0.00Hz Set → <WRITE> EXT → <READ> (136)</pre> <pre>902 EXTvbias 10.00Hz Completed (137)</pre> | <p>A voltage does not need to be applied across terminals 2-5.</p> <p>The bias setting is 10Hz.</p> <p>If a voltage is being applied, the bias setting is as shown above.</p> |
| <p>If you want to set the bias against the set voltage across terminals 2-5.</p> <p>(READ)</p> <p>(WRITE)</p> | <pre>902 EXTvbias → 10.00Hz - 0.5% EXT - 0.5% (138)</pre> <pre>902 EXTvbias → 10.00Hz - 0.5% EXT - 0.5% (139)</pre> | <p>The bias setting with the set voltage should be made in the following procedure.</p> <p>← Preceding set value is displayed.</p> <p>← Current set voltage across terminals 2-5 is displayed in %. The displayed value is changed according as the set voltage.</p> <p>(Value selected in Pr. 73 (5V in this) example) is 100%.</p> <p>If 1V has been set, the bias setting is as follows:</p> |

(Continued)

10.3 Parameters

Parameter List

| Function | Parameter Number | Name | Screen Display | Setting Range | Minimum setting Increment | Factory-setting Increment | Refer Page | |
|--|---|--|-------------------------|-------------------------------|---------------------------|---------------------------|------------|----|
| Basic functions | 0 | Torque boost (manual) | Trq. Bst1 | 0 to 30% | 0.1% | 1% | 49 | |
| | 1 | Maximum frequency limit | Max. F1 | 0 to 60Hz | 0.01Hz | 60Hz | | |
| | 2 | Minimum frequency limit | Min. F1 | 0 to 120Hz | | 0Hz | | |
| | 3 | Base frequency | VFbase F1 | 0 to 400Hz | | 60Hz | | |
| | 4 | Multi-speed setting (high speed) | Preset F1 | 0 to 400Hz | | 60Hz | | |
| | 5 | Multi-speed setting (middle speed) | Preset F2 | 0 to 400Hz | | 30Hz | | |
| | 6 | Multi-speed setting (low speed) | Preset F3 | 0 to 400Hz | | 10Hz | | |
| | 7 | Acceleration time | Acc. T1 | 0 to 3600/0 to 360 sec. | 0.1/0.01 sec. | 15 sec. | | 50 |
| | 8 | Deceleration time | Dec. T1 | 0 to 3600/0 to 360 sec. | 0.1/0.01 sec. | 15 sec. | | |
| 9 | Electronic thermal O/L relay | Set THM | 0 to 3600A | 0.1A | Rated output current | | | |
| 10 | DC injection brake operation frequency | DC Br. F | 0 to 120Hz, 9999 | 0.01Hz | 0Hz | | | |
| 11 | DC injection brake operation time | DC Br. T | 0 to 10 sec, 8888 | 0.1 sec. | 0.5 sec. | | | |
| 12 | DC injection brake voltage | DC Br. V | 0 to 30% | 0.1% | 1% | | | |
| 13 | Starting frequency | Start F | 0 to 60Hz | 0.01Hz | 0.5Hz | | | |
| 14 | Applied load selection | Load VF | 0, 1, 2, 3, 4, 5 | 1 | 0 | | | |
| 15 | Jog frequency | JOG F | 0 to 400Hz | 0.01Hz | 5Hz | 51 | | |
| 16 | Jog acceleration/deceleration time | JOG T | 0 to 3600/0 to 360 sec. | 0.1/0.01 sec. | 15 sec. | | | |
| 17 | External thermal O/L relay input | JOG/OH | 0, 1, 2, 3 | 1 | 0 | | | |
| 18 | High-speed maximum frequency limit | Max. F2 | 0 to 400Hz | 0.01Hz | 60Hz | | | |
| 19 | Base frequency voltage | VFbase V | 0 to 1000V, 9999, 8888 | 0.1V | 9999 | | | |
| 20 | Acceleration/deceleration reference frequency | Acc/Dec F | 0 to 400Hz | 0.01Hz | 60Hz | | | |
| 21 | Acceleration/deceleration time increments | Incr. T | 0, 1 | 1 | 0 | | | |
| 22 | Stall prevention operation level | Stll Pv1 | 0 to 120%, 9999 | 0.1% | 120% | | | |
| 23 | High speed stall prevention operation level | Stll Pv2 | 0 to 120%, 9999 | 0.1% | 9999 | | 52 | |
| 24 | Multi-speed setting (Speed 4) | Preset F4 | 0 to 400Hz, 9999 | 0.01Hz | 9999 | | | |
| 25 | Multi-speed setting (Speed 5) | Preset F5 | | | | | | |
| 26 | Multi-speed setting (Speed 6) | Preset F6 | | | | | | |
| 27 | Multi-speed setting (Speed 7) | Preset F7 | | | | | | |
| 28 | Multi-speed input compensation | Pre. Comp | 0, 1 | 1 | 0 | | | |
| 29 | Acceleration/deceleration pattern | Acc/Dec P | 0, 1, 2, 3 | 1 | 0 | | | |
| 30 | External brake resistor selection | Br. Set | 0, 1 | 1 | 0 | | | |
| 31 | Frequency jump 1A | F jump 1A | 0 to 400Hz, 9999 | 0.01Hz | 9999 | | | |
| 32 | Frequency jump 1B | F jump 1B | | | | | | |
| 33 | Frequency jump 2A | F jump 2A | | | | | | |
| 34 | Frequency jump 2B | F jump 2B | | | | | | |
| 35 | Frequency jump 3A | F jump 3A | | | | | | |
| 36 | Frequency jump 3B | F jump 3B | | | | | | |
| 37 | Speed display | Dispunit | 2 to 10, 11 to 9998 | 1 | 4 | 53 | | |
| 38 | Automatic torque boost | A. TrqBst | 0 to 200% | 0.1% | 0 | | | |
| 39 | Automatic torque boost operation starting current | No Load I | 0 to 3600A | 0.1A | 0 | | | |
| Multi-function output terminal functions | 40 | Output terminal assignment | Selectop | 0 to 9999 | 1 | 1234 | 54 | |
| | 41 | Up-to-frequency sensitivity | SU Range | 0 to 100% | 0.1% | 10% | | |
| | 42 | Output frequency detection | Set FU FW | 0 to 400Hz | 0.01Hz | 6Hz | | |
| Alternate functions | 43 | Output frequency detection at reverse rotation | Set FU RV | 0 to 400Hz, 9999 | 0.01Hz | 9999 | 54 | |
| | 44 | Alternate acceleration/deceleration time | Ac/Dec T2 | 0 to 3600/0 to 360 sec. | 0.1/0.01 sec. | 15 sec. | | |
| | 45 | Alternate deceleration time | Dec T2 | 0 to 3600/0 to 360 sec., 9999 | | 9999 | | |
| | 46 | Alternate torque boost | Trq. Bst2 | 0 to 30%, 9999 | 0.1% | | | |
| | 47 | Alternate V/F (base frequency) | VF base F2 | 0 to 400Hz, 9999 | 0.01Hz | | | |
| | 48 | Alternate stall prevention operation level (current) | Stall 2 I | 0 to 120% | 0.1% | 120% | | |
| | 49 | Alternate stall prevention operation level (frequency) | Stall 2 F | 0 to 400Hz | 0.01Hz | 0 | | |
| | 50 | Alternate output frequency detection | Set FU 2 | 0 to 400Hz | 0.01Hz | 30Hz | | |

Note 1: In the Screen Display section, f indicates a frequency. V a voltage, and I a current.

| Function | Parameter Number | Name | Screen Display | Setting Range | Minimum setting Increment | Factory-setting Increment | Refer Page | | |
|--|--|--|--------------------------|--|---------------------------|---------------------------|------------|------|----|
| Display functions | 51 | Inverter LED display data selection | Set LED | 1 to 14, 17, 18 | 1 | 1 | 55 | | |
| | 52 | PU main display data selection | Set Main | 0, 17, 18, 20, 23, 24 | 1 | 0 | | | |
| | 53 | PU level display data selection | Set Lvl. | 0 to 3, 5 to 14, 17, 18 | 1 | 1 | | | |
| | 54 | FM terminal function selection | Set FM | 1 to 3, 5 to 14, 17, 18, 21, 101 to 103, 105 to 114, 117, 118, 121 | 1 | 1 | | | |
| | 55 | Frequency monitoring reference | Calb FM F | 0 to 400Hz | 0.01Hz | 60Hz | | | |
| | 56 | Current monitoring reference | Calb FM I | 0 to 3600A | 0.1A | Rated output current | | | |
| Automatic restart functions | 57 | Restart coasting time | Restart1 | 0 to 30 sec., 9999 | 0.1 sec. | 9999 | 56 | | |
| | 58 | Restart cushion time | Restrt T2 | 0 to 5 sec. | 0.1 sec. | 0.5 seconds | | | |
| Additional functions | 59 | Remote setting function selection | Rmt Set | 0, 1, 2 | 1 | 0 | 57 | | |
| Operation selection functions | 60 | Intelligent mode selection | Int. Mode | 0, 4 | 1 | 0 | | | |
| | 65 | Hold time at starting freq. | Hold t | 0 to 10 sec. | 0.1 sec. | 0 | | | |
| | 66 | Frequency at which stall prevention level begins to be reduced | Still coF | 0 to 400Hz | 0.01Hz | 60Hz | | | |
| | 67 | Number of retries at alarm occurrence | Retry No | 0 to 10 | 1 | 0 | | | |
| | 68 | Retry waiting time | Retry t | 0 to 10 sec., 9999 | 0.1 sec. | 1 sec. | | | |
| | 69 | Retry count display erase | Retry N | 0 | - | 0 | | | |
| | 70 | Regenerative brake duty | Br. Duty | 0% to 100% (Note 2) | 0.1% | 0% | | | |
| | 71 | Applied motor | Set Motor | 0, 2, 21 to 26, 33 to 36 | 1 | 0 | | | |
| | 72 | PWM mode selection | PWM Mode | 0, 1, 2 | 1 | 0 | | | |
| | 73 | 0 to 5V, 0 to 10V selection | Extf/10V | 0 to 5, 10 to 15 | 1 | 1 | | | |
| | 74 | Response time for analog signal | IP filter | 0 to 8 | 1 | 1 | | | |
| | 75 | Reset selection | RES Mode | 0, 1, 2, 3 | 1 | 0 | | | |
| | 76 | Alarm code output selection | Alarm OP | 0, 1, 2, 3 (Note 4) | 1 | 0 | | | |
| | 77 | Parameter write disable selection | Enable Wr | 0, 1, 2 | 1 | 0 | | | |
| | 78 | Reverse rotation prevention selection | Enable FR | 0, 1, 2 | 1 | 0 | | | |
| | Auto-tuning | 79 | Operation mode selection | Cont Mode | 0 to 5, 7, 8 | 1 | | 0 | 58 |
| | | *80 | Motor capacity | Motor KW | 75 to 1000kW, 9999 | 0.1kW | | 9999 | |
| | | *81 | Number of motor poles | Mpole No | 2, 4, 6, 12, 14, 16, 9999 | 2 | 9999 | | |
| *83 | | Motor rated voltage | Motor rated V | 0 to 1000V | 0.1V | 460V | | | |
| *84 | | Motor rated frequency | Motor rated f | 50 to 120Hz | 0.01Hz | 60Hz | | | |
| *85 to 95 | | Parameters set at factory. Do not reset or adjust. | | | | | | | |
| Auto-tuning | *96 | Auto-tuning setting/status | Tuning | 0,1,101 | 1 | 0 | 59 | | |
| | 97 | Retry selection | Retry select | 0 to 5 | 1 | 0 | | | |
| Auxiliary function | 61 to 64 107 to 116 138,139,141,142 | Parameters for setting auxiliary function. For details, refer to instruction manual. | | | | | | 60 | |
| | 140 | Reduced torque load reduction rate | Load reduction rate | 1 to 2 | 0.01 | 1.75 | | | |
| | 145 | Parameter language change | Language change | 0,1,2,3 | 1 | 0 | | | |
| | 155 | RT terminal activated timing selection | RT activation | 0,1,10,11 | 1 | 0 | | | |
| | 156 | Stall prevention operation selection | Stall select | 0 to 31,100 | 1 | 0 | | | |
| | 157 | OL signal output timer | OL timer | 0 to 25 sec. | 0.1sec. | 0 | | | |
| | 158 | AM terminal function selection | AM function | 1 to 3,5 to 14,17,18,21,9999 | 1 | 9999 | | | |
| | 82,98,99, 117,143,144, 146 to 154, 159 | Parameters set at factory. Do not reset or adjust. | | | | | | | |
| 100 to 106 118 to 127 134 to 137 | Parameters for built-in options. For details, refer to instruction manual. | | | | | | | | |
| 200 to 231 | Parameters to set Program Run. For details, refer to instruction manual. | | | | | | | | |
| Calibration functions | 900 | FM terminal calibration | FM Tune | - | - | - | 60 | | |
| | 901 | AM terminal calibration | AM Tune | - | - | - | | | |
| | 902 | Frequency setting voltage bias | Ext Vbias | 0 to 10V : 0 to 60Hz | 0.1V : 0.01Hz | 0V : 0Hz | | | |
| | 903 | Frequency setting voltage gain | Ext Vgain | 0 to 10V : 1 to 400Hz | 0.1V : 0.01Hz | 5V : 60Hz | | | |
| | 904 | Frequency setting current bias | Ext I bias | 0 to 20mA : 0 to 60Hz | 0.1mA : 0.01Hz | 4mA : 0Hz | | | |
| | 905 | Frequency setting current gain | Ext I gain | 0 to 20mA : 1 to 400Hz | 0.1mA : 0.01Hz | 20mA : 60Hz | | | |

Note 2: The operation factor indicates %ED of the built-in brake transistor operation.

Note 3: parameters allow their set values to be changed during operation if 0 (factory setting) has been set in Pr. 77 (parameter write disable).

Note 4: When the optional T-OPT20 is installed, 2 digit number is to be set. (Refer to T-OPT20 manual.)

Note 5: A140: factory setting value is 460V.

A160: factory setting value is 575V.

11. EXPLANATION OF THE PARAMETERS

11.1 Functions of the Parameters

Pr. 0-Pr. 8 Note: Parameter is abbreviated as Pr.

Pr. 0 Setting torque boost (manual)

- Voltage at 0 Hz can be adjusted (biased) as necessary to provide additional starting torque at low frequencies.

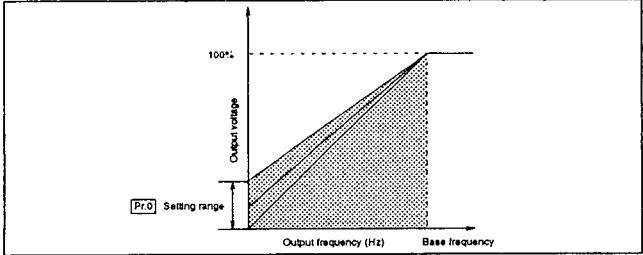

Note 1: 1% of factory-setting (manual torque boost).
 Note 2: When Pr. 80 and Pr. 81 have been set to select Primary Magnetic Flux Control mode, there is no need to set this parameter.

Pr. 1 Pr. 2

Setting Maximum and Minimum frequency limit

Pr. 1 Maximum frequency limit **Pr. 2** Minimum frequency limit
 Maximum and minimum frequency output limit can be clamped.

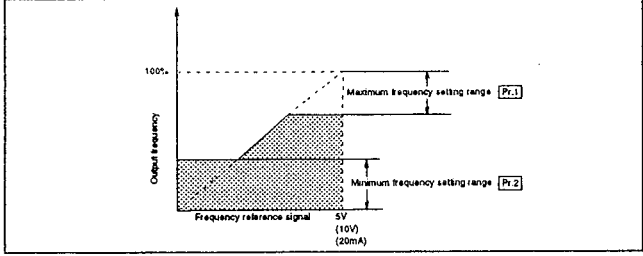

Note: To set a frequency of 60Hz or more, use Pr. 18.

Pr. 3 Setting base frequency

Pr. 3 Base frequency **Pr. 19** Base frequency voltage

- Check motor nameplate for base frequency and voltage data. Enter frequency in Pr.3, and voltage in Pr.19. This will establish the correct volts/Hz ramp. Example: Pr.3 = 60 (Hz), Pr.19 = 460 (volts).
- Pr.19 can be set to any motor nameplate voltage provided it is not higher than the voltage supplied to the inverter. Example: a typical high speed spindle motor nameplated 330V, at 300Hz; set Pr.3 = 300(Hz) and Pr.19 = 330(volts).
- An incorrect setting of either Pr.3 or Pr.19 will apply the wrong V/Hz ramp to the motor resulting in motor heating, and overvoltage trips on overhauling loads.
- Setting 8888 in Pr. 19 results in voltage output equivalent to 95 percent of power supply voltage.

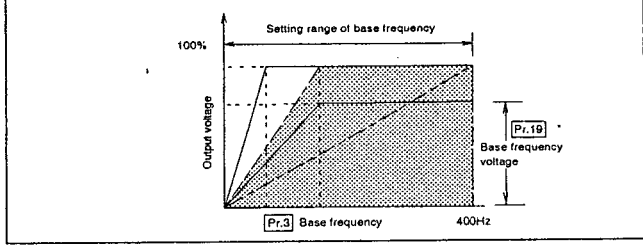

- In general, it is important to set Pr.3 and Pr.19 to rated motor values.
- When Pr. 19 is set to 9999 (factory set value), the maximum output voltage is as the same as the inverter input supply voltage.

Pr. 4 Pr. 5 Pr. 6

Setting multi-speed settings

| | | | |
|-------|----------------------------------|--------|-------------------------|
| Pr. 4 | 1st Multi-speed setting (high) | Pr. 24 | 4th Multi-speed setting |
| Pr. 5 | 2nd Multi-speed setting (medium) | Pr. 25 | 5th Multi-speed setting |
| Pr. 6 | 3rd Multi-speed setting (low) | Pr. 26 | 6th Multi-speed setting |
| | | Pr. 27 | 7th Multi-speed setting |

- Input terminals RH, RM, and RL alone or in combination are used to select each speed.
- Each preset speed can be set to any value between 0-400 Hz during operation of the inverter. The speed can also be set by using the "[▲] [▼]" keys.
- Up to 10 speeds can be set by combining these parameters with JOG frequency (Pr. 15), upper limit frequency (Pr. 1), or lower limit frequency (Pr. 2).

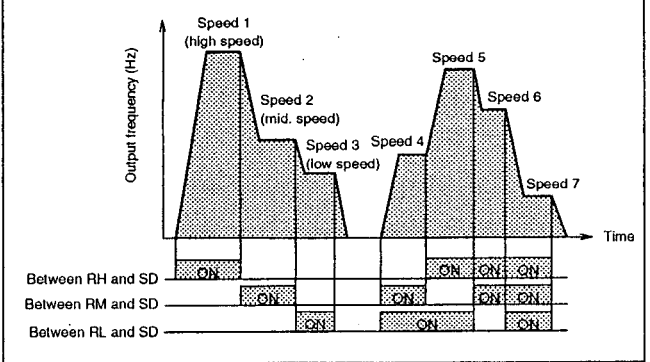

- Notes:
1. When Pr. 24-Pr. 27 are set to 9999 (factory-set value), Speeds 4-7 cannot be selected.
 2. Multi-speed selections take priority over the main speed (between terminals 2/5 or 4/5).
 3. Multi-speeds can also be set during PU operation and external operation.

Pr. 7 Pr. 8

Setting acceleration/deceleration time

| | | | |
|-------|-------------------|--------|--|
| Pr. 7 | Acceleration time | Pr. 20 | Acceleration/deceleration base frequency |
| Pr. 8 | Deceleration time | Pr. 21 | Acceleration/deceleration time unit |

- Set Pr. 7 to the time needed to reach the set value for the Pr. 20. Set Pr. 8 to the time needed to reach the set value for 0Hz.
- For Pr. 21 acceleration/deceleration time unit, the setting range and the minimum setting unit can be set as follows:
 Set value 0: 0-3600 seconds (The minimum setting unit is 0.1 seconds.)
 Set value 1: 0-360 seconds (The minimum setting unit is 0.01 seconds.)

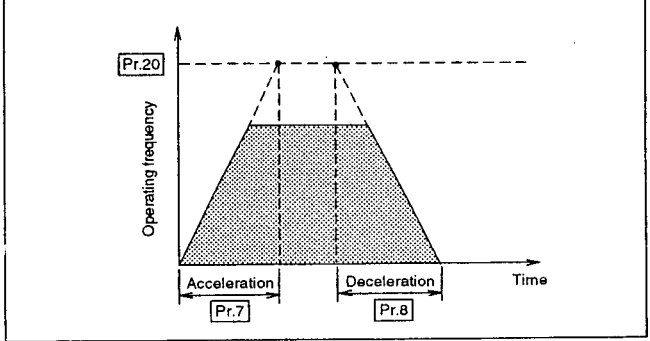

Note: For a S-shaped acceleration/deceleration pattern A (see Pr. 29) only, the value must be the time needed to reach the base frequency (Pr. 3).
 The output wavelength for the wavelength setting signal (analog) is set by the gain (Pr. 903 or Pr. 905).

Pr. 9 Setting value for electronic thermal O/L

- The current value (A) can be directly used as the set value to protect the motor from overheating. Generally, this Pr. is set to the motor rated current. This Pr. allows for the reduction in motor cooling capability during low-speed operation.
- When this parameter is set to "0A", the motor protection function does not operate.
- To use an inverter duty constant torque motor, set Pr. 71 (Applicable Motor) to "21" to select the 100% continuous torque characteristic in the low-speed range. Then set the rated current of the motor for Pr. 9 (Electronic thermal O/L).
- The current value is factory set to the rated output current of the inverter. **Change rated motor current setting.**

Pr. 10 Pr. 11 Pr. 12

Adjusting the DC brake

- Pr. 10 DC injection brake operation frequency
- Pr. 11 DC injection brake operation time Pr. 12 DC injection brake voltage

- Setting DC injection brake torque (* voltage), time, and starting frequency allows the user to adjust the stopping accuracy according to the load.
- Setting 9999 in Pr. 10 causes the brake operation to slow to the starting frequency set in Pr. 13.
- Setting 8888 in Pr. 11 causes the DC brake to begin at MRS-SD short circuiting.

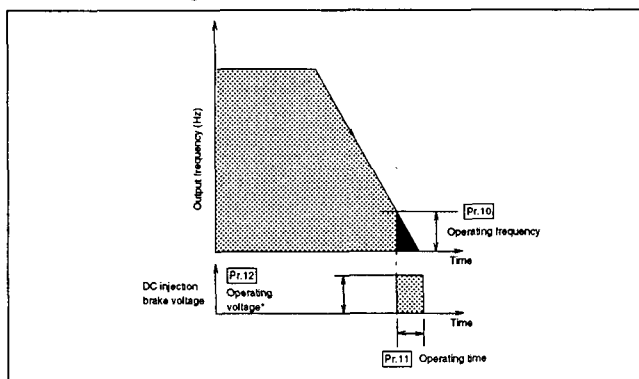

* Factory-set value (for DC injection brake voltage): 1%

Pr. 13 Pr. 65 Setting starting frequency

- Pr. 13 Starting frequency Pr. 65 Hold time at starting freq.

- The starting frequency can be set to any value between 0 to 60 Hz.
- At the start time, the start frequency can be held for a certain time. Therefore, overcurrent can be prevented when a large inertia (GD²) load such as the blower is started.
- Pr. 65 has a setting range of 0 to 10.0 seconds. It was set at 0 second at shipment from the factory.

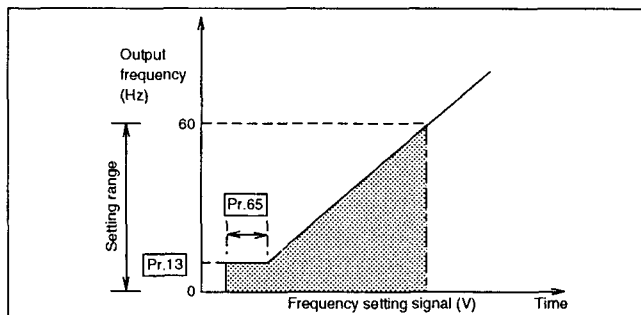

Pr. 14 Pr. 140 Selecting applied load

- The user can select the optimum output characteristics (V/F characteristics) for specific applications or the load characteristic.
- The reduction ratio for reduction torque loads can be set by Pr. 140. k=1 to 2 setting possible. (As standard setting, it should be set to be 1.75)

| Pr. 14 set value | Output characteristics | |
|------------------|------------------------|---|
| 0 | Constant torque load | |
| 1 | Reduced torque load | |
| 2 | Constant torque | Reverse boost 0% |
| 3 | lift/lowering | Forward boost 0% |
| 4 | Terminal RT-SD signal | ON Constant torque load (Pr. 14 = 0 or the same) |
| | OFF | Constant torque lift/lowering reverse boost 0% (Pr. 14 = 2 or the same) |
| 5 | Terminal RT-SD signal | ON Constant torque load (Pr. 14 = 0 or the same) |
| | OFF | Constant torque lift/lowering forward boost 0% (Pr. 14 = 3 or the same) |

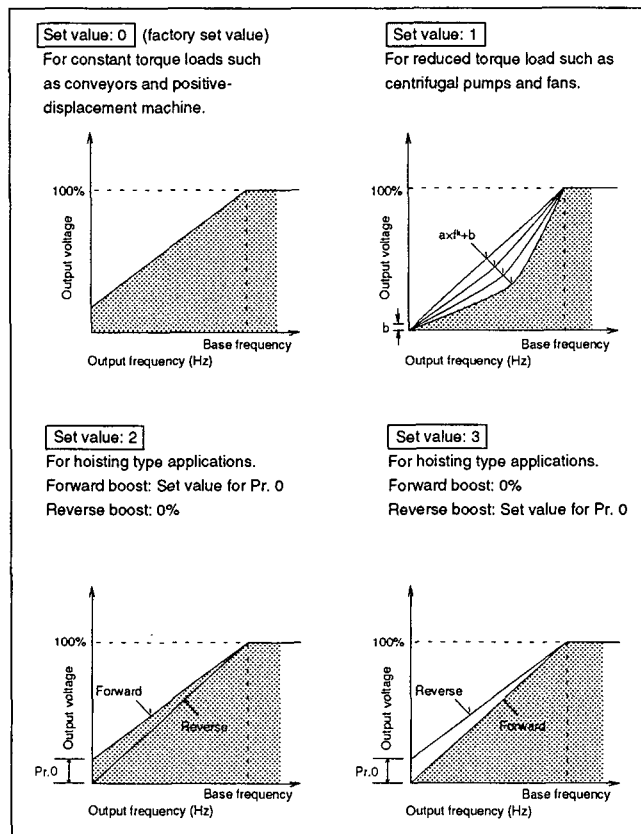

Note: When Pr. 80 and Pr. 81 have been set to select Primary Magnetic Flux Control mode, setting for this parameter is ignored.

Pr. 15-Pr. 66

Pr. 15 Pr. 16 Setting JOG operation

Pr. 15 JOG frequency Pr. 16 JOG acceleration/deceleration time

- For JOG operation, select JOG mode (short between the terminals JOG and SD). JOG operation is started and stopped by a start signal (input at the STF and STR terminals).
- JOG operation can also be performed by using the parameter unit. (Refer to the Instruction Manual.)

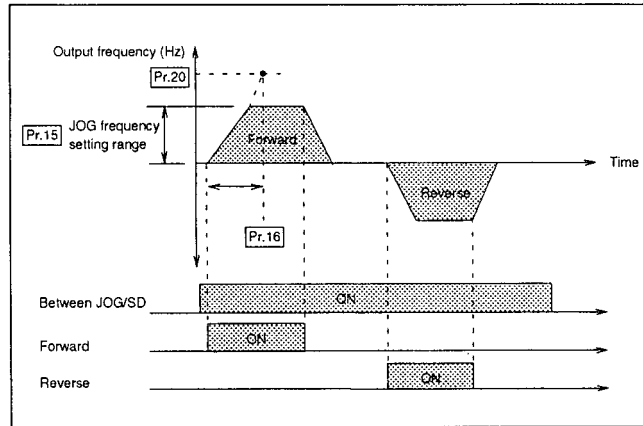

Pr. 17 Selecting external thermal O/L relay input

- The set values 0 and 1 switch the functions of the input terminal JOG/OH. The JOG function inputs the signal contact of the JOG operation select signal. When a thermal O/L relay is installed between the motor and the inverter, or a motor containing a temperature sensor is used, select the OH function which will allow an input from the relay or sensor.
- The set values 2 and 3 switch the function of the MRS terminal to the b-contact input specification (normally closed input).

| Pr.17 set value | Terminals JOG/OH functions | | Terminal MRS function | |
|-----------------|----------------------------|---------------------------------------|-----------------------|-----------------------|
| | JOG mode | OH (External Thermal O/L Relay input) | Normally open input | Normally closed input |
| 0 | ✓ | | ✓ | |
| 1 | | ✓ | ✓ | |
| 2 | ✓ | | | ✓ |
| 3 | | ✓ | | ✓ |

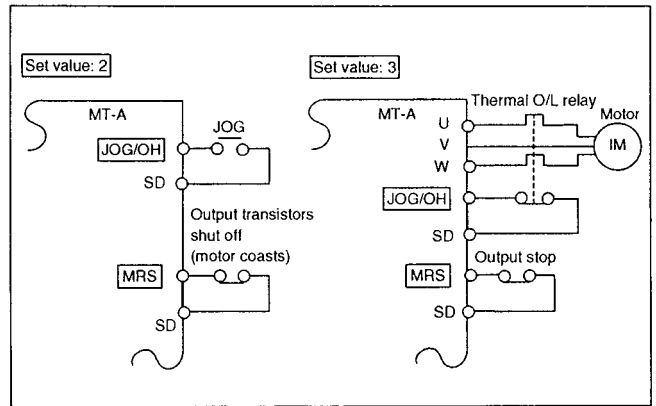
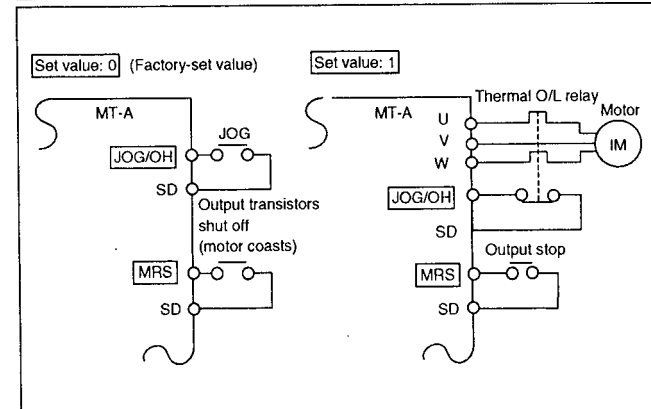

Pr. 18 Setting high-speed maximum frequency limit

- Use this parameter for operation at 60Hz or more.
- When this parameter is set, the maximum frequency parameter, Pr. 1, is automatically changed to this set value.
- Before setting this parameter, confirm that the motor and machine can withstand high-speed operations.

Pr. 19 See description of Pr. 3

Pr. 20 Pr. 21 See description of Pr. 7, Pr. 8

Pr. 22 Pr. 23 Pr. 66

Setting stall prevention operation level

Pr. 22 Stall prevention operation level (current limiting operation level)

Pr. 23 High speed stall prevention operation level (current limiting level reduction rate at 400Hz)

Pr. 66 Frequency at which stall prevention level reduction begins

- Set Pr. 22 for the stall prevention operation level (current limiting level). Normally, set this parameter to 120% (equal to the factory-set value).
- Setting 9999 in Pr. 22 enables stall prevention operation level to be set through the signal to the auxiliary input terminal (Terminal 1).
- To improve the acceleration characteristic of the motor for high speed operation at 60Hz or more, the current limiting level in the high frequency band can be reduced. Pr. 66 sets the frequency at which reduction begins, and Pr. 23 sets the reduction rate.
- When Pr. 23 is set to 9999 (factory-set value), the current limit of the set value for Pr. 22 remains constant at 400Hz.

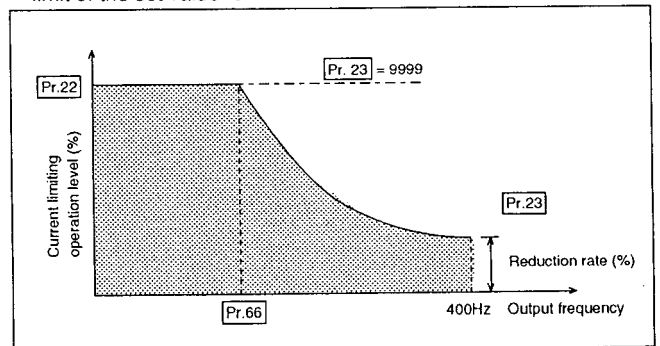

Pr. 28 Selecting multi-speed input compensator

A compensator signal input at terminal "1" enables speed (frequency) compensator to be made to multi-speed settings.

| Set value | Compensator by auxiliary input |
|-----------|-------------------------------------|
| 0 | Not compensated (factory-set value) |
| 1 | Can be compensated |

Pr. 29 Selecting acceleration/deceleration patterns

Different acceleration/deceleration patterns are provided. The selection will depend on the application.

- **Set value "0"** (linear acceleration/deceleration) is effective for most applications.
- **Set value "1"** (S-shaped acceleration/deceleration A) is used to accelerate or decelerate to high-speeds, 60Hz or more, in a short time. This set value selects an acceleration/deceleration pattern with the turning point of the S-shaped curve at fb (base frequency). This pattern is suited for use with machine tools applications.
- **Set value "2"** (S-shaped acceleration/deceleration B) is used to set constant, S-shaped acceleration or deceleration at a frequency between f2 (current frequency) and f1 (target frequency). This function can reduce shocks arising at acceleration or deceleration.

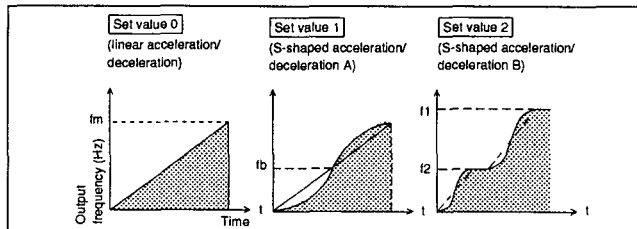

- **Set value "3"** activates the backlash-reduction function for use when the motor is connected to a high backlash load. This function temporarily changes the output frequency at acceleration/deceleration to reduce shocks (or backlash). Use Pr. 33 to Pr. 36 to set the parameters for backlash reduction.

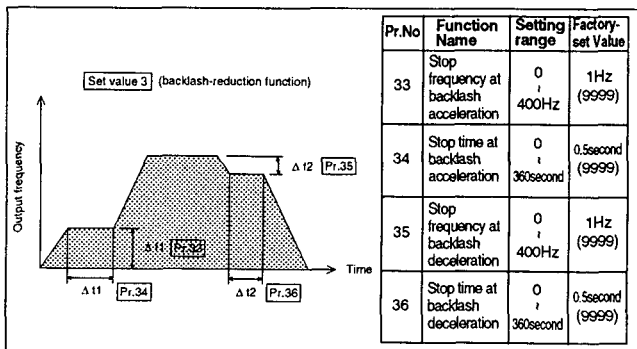

* Using Pr. 31 and Pr. 32 ensures that the frequency jump function will remain valid.

Pr. 30 Pr. 70 Setting regenerative brake

Pr. 30 External brake resistor selection Pr. 70 Maximum regenerative brake duty

- To use optional brake unit and brake resistor, set Pr. 30 to 1 and Pr. 70 for %ED. For standard brake unit and brake resistor, %ED is 5% (30 sec/10 min).
- Pr. 70 setting must match the allowable brake usage factor of the transistor in the brake unit.
- When Pr. 30 is set to be 0, Pr. 70 is not displayed.

Pr. 31 Pr. 32 Pr. 33 Pr. 34 Pr. 35 Pr. 36

Frequency jump

- To avoid resonance during operation due to natural vibration of mechanical system, the resonant frequency can be jumped. Three jump points can be set, and the jump frequency can be set above or below each jump point.
- A frequency reference command within the frequency jump range will result in operation at 1A, 2A, or 3A (below the jump frequency range).

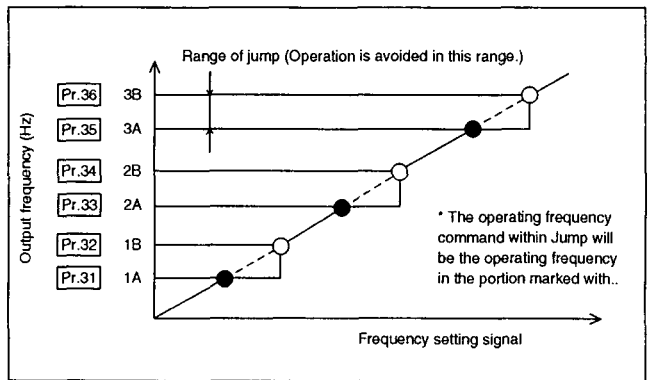

- Notes:
1. When the value "9999" is set (factory-set value), frequency jump is not executed.
 2. When Pr. 29 is set to "3", Pr. 33-Pr. 36 are switched to the backlash correction setting function. (Pr. 31 and Pr. 32 remain valid as the frequency jump function.)
 3. The operating frequency within the setting range is applied to Jump during acceleration/deceleration.

Pr. 37-Pr. 41

Pr. 37 Setting speed indication unit

- The operating speed of a machine can be displayed on the panel as the machine is operating. The speed can be displayed on the LED's of the inverter as well as the main monitor of the parameter unit (PU).
- Set the speed indication unit according to the number motor poles or any linear process variable. For a linear process variable, the value set will be the value displayed at 60Hz output.
- This setting is valid only when the Inverter LED Display or PU Main Display has been selected for operation speed indication (see Pr. 51 and Pr. 52).

| Pr.37 set value | Operation speed indication |
|-----------------|---|
| 2 ~ 10 | <ul style="list-style-type: none"> •The set value is the number of poles of the motor. •The rotation speed of the motor is displayed. Example: For the set value of "2", "3600" rpm is displayed at 60 Hz output. |
| 11 ~ 9998 | <ul style="list-style-type: none"> •The set value is the machine speed for 60Hz operation. Example: For the set value of "950" (meters/min), "950" (without the indication unit) is displayed at 60 Hz output. |

- Notes: 1. Only this Pr. can be set in linear process variable units. Use the frequency unit (Hz) to set other frequency related parameters.
2. In V/F Control mode, the motor rotation speed is output frequency and does not indicate the real rotation speed. When Pr. 80 and Pr. 81 have been set to select Primary Magnetic Flux Control mode, the rotation speed is calculated based on an estimate of the motor slip value.
3. The factory-set value is "4". (1800 r/min is indicated at the 60Hz operation)

Pr. 38 Pr. 39 Setting automatic torque boost

Pr. 38 Automatic torque boost Pr. 39 Automatic torque boost activation level

- This function detects load current and automatically adjusts the output voltage of the inverter in order to increase the motor's torque output.

| Function No. | Set value |
|--------------|---|
| 38 | Boost compensation value (%) 0: automatic torque boost disable (factory setting) Normally set 100% to operate the automatic torque boost. |
| 39 | Current level at which the automatic torque boost is activated (A) (Normally, set 0A for this parameter.) |

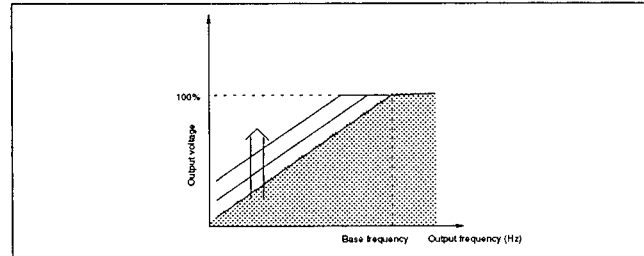

Pr. 40 Setting multi-function output terminal assignment

- This function individually changes and assigns the function of each of the output terminals SU, IPF, OL, and FU to ten different functions. Set values are assigned to Pr. 40 as a four-digit integer. Each digit indicates the function of each terminal.

Pr. 40: 1st digit, 2nd digit, 3rd digit, and 4th digit (Factory-set values: 1 2 3 4)

Example: The set value of Pr. 40 is 3249.

Terminal SU: OL (overload alarm) signal

Terminal IPF: IPF/UVT (instantaneous power failure/under voltage alarm) signal

Terminal OL: FU1 (frequency detection) signal

Terminal FU: PU (in PU operation) signal

| Set value | Function abbreviation | Function name | Description of operation | Related Pr |
|-----------|-----------------------|--|--|------------|
| 0 | RUN | Under Inverter Operation | Output when the inverter is operating at a frequency higher than the start frequency. | - |
| 1 | SU | Up-to-set frequency | Output when output frequency reaches the set frequency. | Pr.41 |
| 2 | IPF/UVT | Instantaneous power failure or under voltage | Output when an instantaneous power failure or under voltage occurs. | - |
| 3 | OL | Overload alarm | Output when current limiting function is activated. | Pr.22,23 |
| 4 | FU1 | Frequency detection | Output when frequency is higher than the specified detection frequency. | Pr.42,43 |
| 5 | FU2 | Alternate frequency detection | Output when frequency is higher than the specified detection frequency. | Pr.50 |
| 6 | RBP | Regenerative brake pre-alarm | Output for pre-alarm when regenerative brake utilization reaches 85% of the utilization rate set for Pr.70.13. | Pr.70 |
| 7 | THP | Electronic thermal O/L alarm | Output when the electronic thermal O/L value reaches 85% of the set level. | Pr.9 |
| 8 | PRG | In Program mode operation | Output when the inverter is operating in Program mode. | Pr.79 |
| 9 | PU | PU operation mode | Output when PU Operation mode is selected. | - |

Note: The function of the RUN terminal (output during invert operation) is fixed and cannot be changed by Pr. 40.

Note: "Output" means that the internal transistor for open collector output is turned on (the circuit is connected).

Pr. 41 Adjusting up-to-frequency sensitivity

- The sensitivity can be adjusted within 0 to ±100% of the operation frequency.

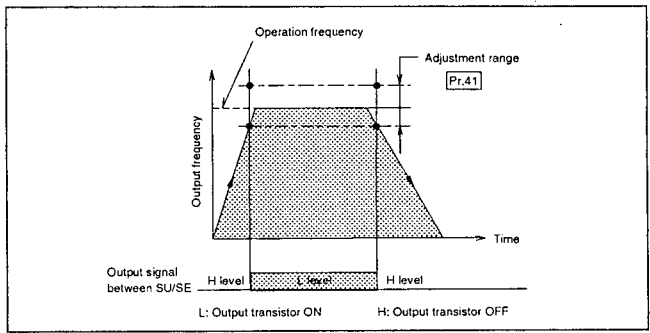

Pr. 42 Pr. 43 Setting output frequency detection

Pr.42 Output frequency detection

Pr.43 Output frequency detection for reverse operations

- The signal level is L when output frequency reaches or exceeds any set detection frequency (the value set for Pr.42 output frequency detection.) The signal is H when output frequency is lower than this detection frequency. This function is useful for the operation or the open signal of an electromagnetic brake.

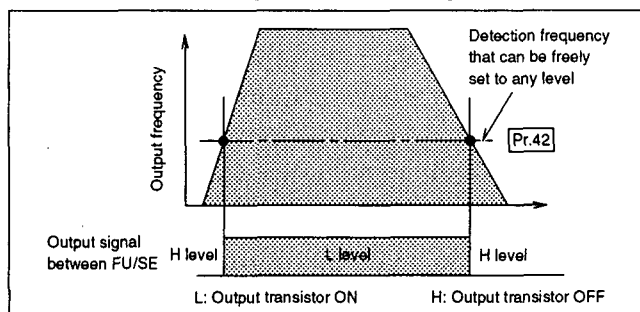

- Setting Pr.43 enables activation of frequency detection specifically for reverse operation. (In this case, the set value of Pr.42 is valid only for forward operation.) This function is effective, for example, in changing the timing of electro-magnetic brake operation between forward (lifting) and reverse (lowering) vertical movement. The factory-set value is "9999", which will be the set value for Pr.42 for both for ward and reverse.

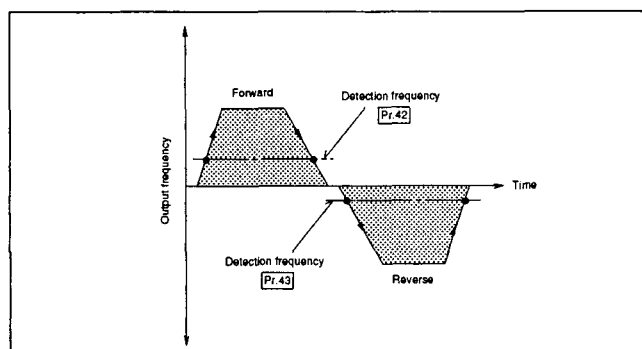
**Pr. 44 Pr. 45 Pr. 46 Pr. 47****Setting secondary control functions**

Pr.44 Alternate acceleration/deceleration time

Pr.45 Alternate deceleration time

Pr.46 Alternate torque boost (manual)

Pr.47 Alternate V/F (base frequency)

- The acceleration/deceleration time and the boost setting can be changed at the same time through the external contact signal (input between the terminals RT and SD).
- This function is effective in switching two motors that have different parameters, such as lifting and traverse.

| Setting function | Parameter No. | Signal between RT and SD terminals | |
|-----------------------|---------------|------------------------------------|----|
| | | OFF | ON |
| Acceleration time | Pr.7 | √ | |
| | Pr.44 | | √ |
| Deceleration time | Pr.8 | √ | |
| | Pr.45 | | √ |
| Torque boost (manual) | Pr.0 | √ | |
| | Pr.46 | | √ |
| Base frequency | Pr.3 | √ | |
| | Pr.47 | | √ |

Note: When "9999" (factory-set value) is set for Pr.45, the set value of Pr.44 is used for both alternate acceleration and deceleration times.

Pr. 48 Pr. 49**Setting the alternate stall prevention operation function**

Pr.48 Alternate stall prevention (current limiting) operating current

Pr.49 Alternate stall prevention (current limiting) operating frequency

- This function can change the stall prevention (current limiting) operation level within a range between 0 Hz to the frequency set for Pr.49. This function is effective when applying low torque and speed against a stationary object (holding a load in position).
- This function does not operate at acceleration, and is valid only at deceleration or at a constant speed.
- When Pr.49 is set to "0" (the factory-set value), the Alternate stall prevention function does not operate.

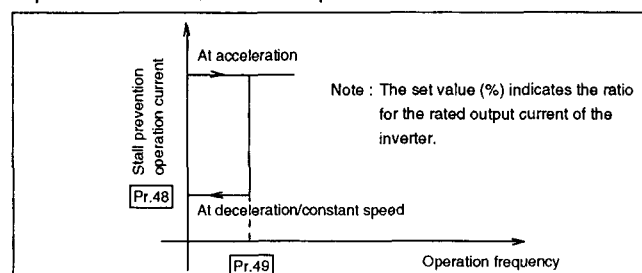
**Pr.50 Setting alternate output frequency detection**

- In addition to the output frequency detection set for Pr.42 and Pr.43, output frequency detection can be set for Pr.50.
- This function can be output at any of the SU, IPF, OL, and FU terminals by setting "5" (FU2) for any of the four digits (from the 1st to 4th digits) of Pr.40. The output signal is turned on at a frequencies higher than or equal to the set frequency (See the description of Pr.42 and Pr.43.).

Pr. 51-Pr. 56

Pr. 51 **Pr. 52** **Pr. 53** **Pr. 54** **Pr. 158**

Selecting monitor and output signal

- Pr.51** Inverter LED display data selection **Pr.53** PU level display data selection
- Pr.52** PU main display data selection **Pr.54** FM/AM terminal function selection
- Pr.158** AM terminal function selection

- Set the monitor and output signal to the appropriate number selecting from the 22 signal types listed below.
- There are two types of output signals: the FM terminal which is a pulse train output and the AM terminal which is an analog output. Different signals can be output at the same time. Select the signals using Pr.54 and Pr.158.
- Factory-set values Pr.51:1 (The Alarm code is automatically displayed when a failure has occurred.), Pr.52:0, Pr.53:1, Pr.54:1, Pr.158:9999.

| Signal type | Indication unit | Parameter sel value | | | | | | Full-scale value of FM, AM, and level meter |
|-------------------------------------|-----------------|-----------------------|--------------------------|-------------------------|----------------------|----------------------|-----------------------|---|
| | | Pr.51 Inverter LED | Pr.52 PU main monitor | Pr.53 PU level meter | Pr.54 FM terminal | Pr.54 AM terminal | Pr.158 AM terminal | |
| No indication | - | N | N | 0 | N | N | N | - |
| Output frequency | Hz | 1 | 0 | 1 | 1 | 101 | 1 | Pr.55 |
| Output current | A | 2 | 0 | 2 | 2 | 102 | 2 | Pr.56 |
| Output voltage | V | 3 | 0 | 3 | 3 | 103 | 3 | 400 V or 800 V |
| Defect | - | 4 | 0 | N | N | N | N | - |
| Frequency set value | Hz | 5 | * | 5 | 5 | 105 | 5 | Pr.55 |
| Operation speed | (r/min) | 6 | * | 6 | 6 | 106 | 6 | Value of Pr.55 converted by the value of Pr.37 |
| Motor torque** | % | 7 | * | 7 | 7 | 107 | 7 | Rated torque of applied motor x 2 |
| Converter output voltage | V | 8 | * | 8 | 8 | 108 | 8 | 400 V or 800 V |
| Regenerative brake utilization rate | % | 9 | * | 9 | 9 | 109 | 9 | Pr.70 |
| Electronic thermal O/L load ratio | % | 10 | * | 10 | 10 | 110 | 10 | Thermal operation level |
| Output current peak value | A | 11 | * | 11 | 11 | 111 | 11 | Pr.56 |
| Converter output voltage peak value | V | 12 | * | 12 | 12 | 112 | 12 | 400 V or 800 |
| Input power*** | kW | 13 | * | 13 | 13 | 113 | 13 | Rated power of applied motor x 2 |
| Output power*** | kW | 14 | * | 14 | 14 | 114 | 14 | Rated power of applied motor x 2 |
| Input terminal status | - | N | * | N | N | N | N | - |
| Output terminal status | - | N | N | N | N | N | N | - |
| Load meter | % | 17 | 17 | 17 | 17 | 117 | 17 | Pr.56 |
| Motor exciting current | A | 18 | 18 | 18 | 18 | 118 | 18 | Pr.56 |
| Aggregate operation time | hr | N | 20 | N | N | N | N | - |
| Reference voltage output | - | N | N | N | 21 | 121 | 21 | 1440Hz is output to the FM terminal. The full-scale voltage is output to the AM terminal. |
| Actual operating time | hr | N | 23 | N | N | N | N | - |
| Motor load rate | % | N | 24 | N | N | N | N | - |

- Note: A monitoring function marked "N" cannot be selected.
- Note: After setting "0" for Pr.52 (PU main monitor), the monitor signals can be selected. To display sequentially, use the SHIFT key. ("0" is the factory-set value.)
- Note: The load meter value is indicated in %, with the current value set for Pr.56 representing 100%.
- * Select signals from the frequency set value to the output terminal status of the PU main monitor by selecting "other monitor" of PU Operation.
 - ** Motor torque display is valid only when in the primary magnetic flux control mode.
 - *** Full-scale value indication is based on variable torque inverter rating.

Note: Relationship between Pr.54 (FM, AM terminal function selection) and Pr.158 is as follows.

| Pr.158 set value | Pr.54 set value | FM, AM terminal output status | Remarks |
|------------------|-----------------|---|--|
| 9999 | 1-21 | Both FM and AM terminal output signal set in Pr.54. | Cray coad soon Pr.900 may be read and written. |
| | 101-121 | | Cray coad soon Pr.901 may be read and written. |
| 1-21 | 1-21 | FM terminal output signal set in Pr.54. | Calibration Pr.900 and Pr.901 may be read and written. |
| | 101-121 | AM terminal output signal set in Pr.158. | |

- * Even when setting Pr.54 as 101-102, the same signal as when setting at 22 will be output from the FM terminal.
- Note: Pr.51 setting as 22 should be avoided, as this is a special setting per formed exclusively by the manufacturer.

Pr. 55 **Pr. 56** **Setting monitor reference**

Pr.55 Frequency monitor reference **Pr.56** Current monitor reference

- Set the frequency or current value to be used as a refer ence to indicate when frequency or current is selected to indicate the FM terminal, AM terminal, and PU level meter.

| Monitor reference set parameter | Monitor contents selection. Setting unit in (.) | PU level display selection (set value of Pr.53) | FM/AM terminal function selection (set value of Pr.54) | |
|--------------------------------------|---|---|--|--|
| Pr.55 Frequency monitor reference | Output frequency (Hz) | 1 | 1 | 101 |
| | Frequency set value (Hz) | 5 | 5 | 105 |
| | Operation speed (Pr.37) | 6 | 6 | 106 |
| Pr.56 Current monitor reference | Output current (A) | 2 | 2 | 102 |
| | Output current peak value (Hz) | 11 | 11 | 111 |
| | Load meter (%) | 17 | 17 | 117 |
| | Motor excitation current (A) | 18 | 18 | 118 |
| Method of setting by Pr.55 and Pr.56 | | Set the value such that the indication on the PU level meter is 100%. | Set the value so that output pulse train output at the FM terminal is 1440 Hz. | Set the value so that output voltage at the AM terminal is 10 V. |

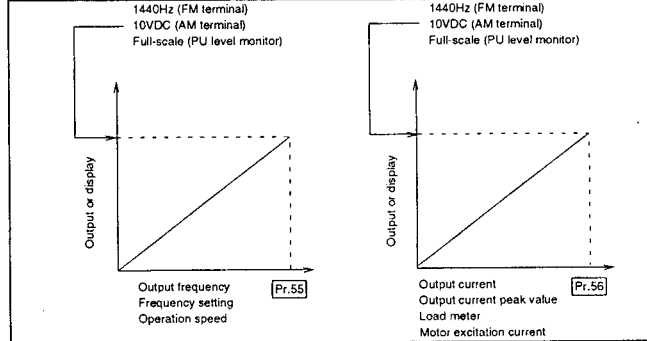

- Notes:1 The maximum pulse train output at the FM terminal is 2400 Hz.
2 The maximum voltage at the AM terminal is 10 VDC.

Pr. 57 Pr. 58

Restart operation after instantaneous power failure or commercial switching

Pr.57 Restart coasting time after an instantaneous power failure or switching across the line operation.

Pr.58 Rise cushion time for automatic restart.

- This function allows the inverter to start into a spinning motor.
- Pr.57 (free running time)

| Set value | Instantaneous power failure restart enabled/disabled | Restart operation enabled/disabled |
|------------------------|--|------------------------------------|
| 9999 (factory-setting) | disabled | enabled (5 seconds free run time) |
| 0, 0.1 to 30* | enabled | enabled |

Free run time meaning time taken until the control restarts after reset.

- When Pr.57 is set to "0", the free running time is set to 5 seconds. This setting is appropriate for general operation. However, the time can be adjusted within a range, of 0.1 to 30 seconds according to the inertia of the load (GD^2 (WK²)) and the magnitude of torque. (The system starts at this time if the load quickly decelerates to 2 Hz within the time set with Pr.57.)
- If this setting is applied to a load with a high rate of deceleration, overcurrent may occur. The unit must then be restarted after it has stopped.
- Pr.58 Setting of output voltage (rise time)
In general, setting this parameter to 0.5 seconds (the factory-set value) is enough for operation. However, the output voltage rise time at restart control can be adjusted in the range of 0.1 to 5 seconds according to the value of the load requirements/specifications (inertia or torque).

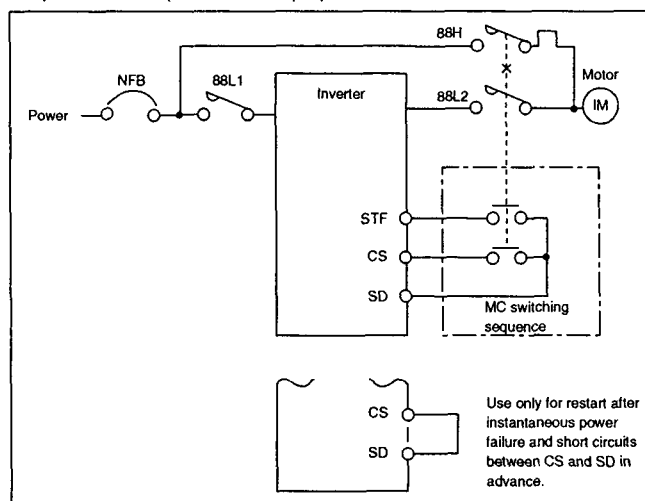

Pr. 59 Selecting remote setting function

- Setting "1" or "2" for Pr.59 enables changing of the RH and RM terminal functions to the remotely set input functions.
- The functions equivalent to those of the remote setting box FR-FK of the FR series setting box (optional) can only be obtained by setting the parameters.

| Pr. 59 set value | Operation | |
|------------------|-------------------------|---|
| | Remote setting function | Frequency set value storage function(*) |
| 0 | X | - |
| 1 | ○ | ○ |
| 2 | ○ | X |

X: Not available ○: Available

- If the circuit between the RH and SD terminals or between the RM and SD terminals has been opened for one minute or more, the set value of operation frequency at that time is stored in memory. After the power is turned off and then turned on again, operation is resumed at this set value.

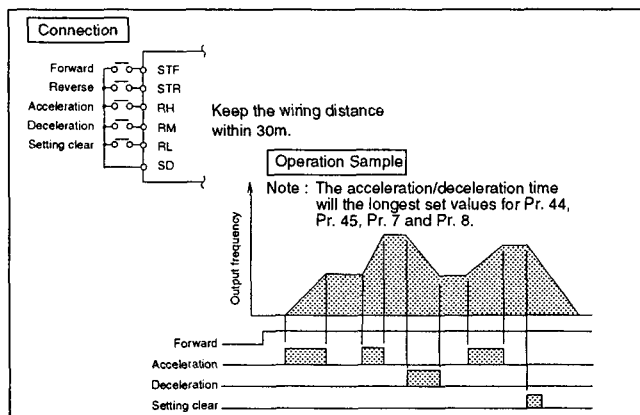

Pr. 60 Intelligent mode selection

| Pr.60 set value | Set function | Operation | Automatically set parameter |
|---------------------|-------------------------|---|-----------------------------|
| 0 (factory setting) | Ordinary operation mode | - | - |
| 4 | Energy-saving mode | Tunes the inverter output voltage on line so that the inverter output voltage is minimized during constant-speed operation. Appropriate for energy-saving application such as fan and pump. | Output voltage |

Pr. 65-Pr. 72

Pr. 65 See description of Pr.13.

Pr. 66 See description of Pr.22.

Pr. 67 **Pr. 68** **Pr. 69** **Pr. 97** **Retry function**

Pr.67 No. of retries after alarm occurrence

Pr.68 Retry execution wait time

Pr.69 Erase display of No. of retry executions

Pr.97 Retry select

- Retry is a function that makes the inverter automatically reset the inverter alarm, restart and continue operations.

- Alarm details made by retry may be selected in Pr.97.

| Pr.97 set value | Alarm details made in retry |
|-----------------|--|
| 0 | Retry times exceeded, all retry other than CPU error (excludes inverter breakdown). |
| 1 | Overcurrent cutoff (OC1-3) |
| 2 | Regenerative overcurrent cutoff (OV1-3) |
| 3 | Overcurrent cutoff (OC1-3), regenerative overcurrent cutoff (OV1-3). |
| 4 | Overcurrent cutoff (OC1-3), regenerative overcurrent cutoff (OV1-3), Instant service interruption protection (IPF), inadequate voltage protection (UVT), Brake transistor malfunction inspection (BE), ground overcurrent protection (GF), parameter error (PE), shutdown through stall prevention operation (OLT), built-in option malfunction. |
| | Overcurrent cutoff during acceleration (OC1), overcurrent cutoff during deceleration (OC3). |
| | |
| | |
| 5 | Overcurrent cutoff during acceleration (OC1), overcurrent cutoff during deceleration (OC3). |

- You can set Pr.67 to the number of retries to be made after an alarm has occurred.

| Pr.67 set value | No. of retries |
|-----------------------|--------------------|
| 0 (Factory-set value) | Retry is not made. |
| 1 to 10 | 1 to 10 retries |

- You can set Pr.68 to the wait time needed after the inverter alarm is issued and before restart is executed. When "9999" is used as the set value, the inverter will not execute a retry function.

- You can see the accumulated number of restarts made by retry by reading Pr.69. The set value of "0" erases this aggregate number.

Notes: 1 The inverter automatically starts operation when the retry wait time set for Pr.68 has elapsed. When this function is active, the operator should be aware that the motor may start unexpectedly!

- 2 When the reset function is activated before restart, accumulated data, such as data of the electronic thermal and the utilization rate of regenerative brake, is not reset (in the different manner as by power-on reset).

Pr. 70 See description of Pr.30.

Pr. 71 Selecting applicable motor

| Pr.71 setting | | Motor type | Details | |
|---------------|------|-----------------|----------------------|--|
| V.T. | C.T. | | Control method | Constant setting |
| 0 | - | Standard | V/F | |
| - | 21 | Constant torque | V/F | |
| 2 | 22 | Standard | V/F 5-point adjust | |
| - | 23 | Standard | Magnetic flux vector | Auto-tuning setting. |
| - | 33 | Constant torque | Magnetic flux vector | Auto-tuning setting. |
| - | 24 | Standard | Magnetic flux vector | Divert auto-tuning data, change setting. |
| - | 34 | Constant torque | Magnetic flux vector | Divert auto-tuning data, change setting. |
| - | 25 | Standard | Magnetic flux vector | Motor constant input directly, motor wiring is Star wiring. |
| - | 35 | Constant torque | Magnetic flux vector | Motor constant input directly, motor wiring is Star wiring. |
| - | 26 | Standard | Magnetic flux vector | Motor constant input directly, motor wiring is Delta wiring. |
| - | 36 | Constant torque | Magnetic flux vector | Motor constant input directly, motor wiring is Delta wiring. |

Pr.71 = 0, 2 Electronic thermal setting equivalent to V.T. capacity.

Pr.71 = 21 to 26, 33 to 36 . Electronic thermal setting equivalent to C.T. capacity.

Pr. 72 Changing of PWM mode

- The MT-A series PWM mode can be changed by using Pr.72 when trying to reduce the audible sound from motor.

| Pr.72 set value | PWM mode |
|-----------------|------------------------------|
| 0 | No acoustic noise tuning |
| 1 | Acoustic noise tuning |
| 2 (Note 1) | Sine-wave filter application |

Note 1: When the optional sine-wave filter is used, set 2 at Pr.72. Here, operation is impossible at 60Hz or more when 2 is set at Pr.72.

Note 2: With the optional sine-wave filter, next largest inverter for the motor rating should be selected.

Pr. 73 Frequency command voltage range selection

- Set the input specifications for terminals 1 and 2 and use the override function.

| Pr.73 set value | Terminal AU signal | Terminal 2 input voltage | Terminal 1 input voltage *1 | Terminal 4 input (4 to 20 mA) | Override function *2 | Reversible polarity | | | |
|-----------------|--------------------|--------------------------|-----------------------------|-------------------------------|----------------------|---------------------|--------|----------|----|
| 0 | OFF | 0 to 10V | 0 to±10V | Inactive | Inactive | *3 | | | |
| 1 | | 0 to 5V | 0 to±10V | | | | | | |
| 2 | | 0 to 10V | 0 to±5V | | | | | | |
| 3 | | 0 to 5V | 0 to±5V | | | | | | |
| 4 | | 0 to 10V | 0 to±10V | | | | | | |
| 5 | | 0 to 5V | 0 to±5V | | Active | | | | |
| 10 | | 0 to 10V | 0 to±10V | | | | | | |
| 11 | | 0 to 5V | 0 to±10V | | | | | | |
| 12 | | 0 to 10V | 0 to±5V | | | | | | |
| 13 | | 0 to 5V | 0 to±5V | | | | | | |
| 14 | | 0 to 10V | 0 to±10V | | Active | | | | |
| 15 | | 0 to 5V | 0 to±5V | | | | | | |
| 0 | | ON | Inactive | | | 0 to±10V | Active | Inactive | *3 |
| 1 | | | | | | 0 to±10V | | | |
| 2 | | | | | | 0 to±5V | | | |
| 3 | 0 to±5V | | | | | | | | |
| 4 | 0 to 10V | | | Inactive | | | | | |
| 5 | 0 to 5V | | Active | | | | | | |
| 10 | 0 to±10V | | | | | | | | |
| 11 | 0 to±10V | | | | | | | | |
| 12 | 0 to±5V | | | | | | | | |
| 13 | 0 to±5V | | | | | | | | |
| 14 | 0 to 10V | | Inactive | Active | | | | | |
| 15 | 0 to 5V | | | | | | | | |

*1:Terminal 1 (auxiliary frequency setting input) is added to the main speed-setting signal at terminal 2 or 4.

*2:When override is selected, terminal 1 or 4 will be the main speed-setting signal, and terminal 2 will be the override signal (50 to 150% at 0 to 5V or 0 to 10V).

*3:Frequency command signals with a negative polarity cannot be accepted.

Notes: 1. When "the maximum output frequency at the maximum frequency voltage (or current) input signal" is changed/calibrated, set Pr.903 (Pr.905 for current signal). In this case, it is not necessary to give the voltage (or current) signal to the inverter. Just setting Pr.s works. Setting of Accel/Decel time is not affected by the setting of Pr.73 because the accel/decel time is defined by the slope from zero Hz to the setting of Pr.20, accel/decel base frequency.

2. shows factory setting.
3. When the set value of Pr.22 is "9999", the value of terminal 1 is for stall prevention level setting.

Pr. 74 Input filter time constant

- You can set the built-in filter constant of the input section of the external voltage or current frequency setting signal. This function is effective in removing noise from the frequency-setting circuit.
- If stable operation cannot be obtained due to the influence of noise, use a higher filter time constant. The higher the set value, the lower the response.

Pr. 75 Reset selection/PU disconnection detection

- The Reset function (terminal RES) can be set to allow for reset anytime or only at alarm occurrence. This Pr. can also be set to cause an inverter alarm stop when the PU is disconnected.

| Set value | Reset input is always enabled (the factory-set value).* | After the parameter unit is removed, operation continues. |
|-------------|--|--|
| Set value 0 | Reset input is always enabled (the factory-set value).* | After the parameter unit is removed, operation continues. |
| Set value 1 | Reset input is enabled only when the protective function is activated. | When the parameter unit is disconnected, the inverter LED display shows the error display and the inverter output is shut off. |
| Set value 2 | Reset input is always enabled. | |
| Set value 3 | Reset input is enabled only when the protective function is activated. | |

* When the circuit between the RES and SD terminals is turned on during operation, the inverter output is shut off, the contents of the electronic thermal O/L and regenerative brake utilization rate are reset, and the motor coasts.

Pr. 76 Alarm code output selection

- When an alarm arises, the details of the alarm can be output through the 4 bit digital signal at the open collector output terminal. When programmed operation has been selected, this function displays the operation block selection.

| Set value | Output terminal | | | |
|------------------------------|--|---------------------------|----------------------------|---------------------------|
| | SU | IPU | OL | FU |
| 0 (factory-set value) | By output terminal assignment (Pr.40) | | | |
| 1 | Alarm code bit 3 | Alarm code bit 2 | Alarm code bit 1 | Alarm code bit 0 |
| 2 | Normal operation Same as setting 0 When an alarm arises Alarm code signal | | | |
| 3 (Program operation output) | Output at time up | Operating the third group | Operating the second group | Operating the first group |

Note 1: For the contents of the alarm code, see page 26.

Pr. 77 Parameter write inhibit selection

- You can inhibit the parameter write function to prevent accidental or unauthorized tampering.

| Set value | Write inhibit function |
|-----------|--|
| 0 | Write function is enabled only when run command is off and inverter is in the PU OP mode. Exception: Pr.4 - 6, Pr.24 - 27, Pr.51 - 56, and Pr.900 - 901 can be changed in any mode. |
| 1 | Write function is disabled in any mode. Exception: Pr.77 and Pr.79 can be set when inverter is in the PU OP mode. |
| 2 | Write function is enabled in any mode. Exception: Pr.22, Pr.23, Pr.48, Pr.49, Pr.60, Pr.66, Pr.71, Pr.79 to Pr.81 can only be set when run command is off and inverter is in the PU OP mode. |

Pr. 78 Reverse run prevention selection

- Set this parameter to prevent problems with reverse operation due to incorrect start signal inputs.

| Set value | Direction of rotation |
|-----------|---|
| 0 | Both forward and reverse rotations are enabled (factory-set value). |
| 1 | Reverse rotation is disabled. |
| 2 | Forward rotation is disabled. |

Note: This setting is valid for both parameter unit operation and external operation.

Pr. 79-Pr. 145

Pr. 79 Operation mode selection

- The inverter operation mode may be operated by external signal or by the parameter unit. You may limit the operation mode to one of these two modes, or you may use both modes.

| | |
|------------------|--|
| Set value 0 | Operation is enabled by switching between the parameter unit and the external operation source (the factory-set value). |
| Set value 1 | Operation is enabled only by the parameter unit. |
| Set value 2 | Operation is enabled only by the external operation source. |
| Set value 3 (*1) | Operation frequency: Set by the parameter unit. Start signal: External signal is input. |
| Set value 4 (*1) | Operation frequency: External signal is input. Start signal: Input by the parameter unit. |
| Set value 5 | Program operation Operation start: STF; Timer reset: STR Group selection: RH, RM, RL |
| Set value 7 | Parameter unit operation mode is prohibited. |
| Set value 8 | Switchover between the parameter unit and external operation mode is possible. <ul style="list-style-type: none"> With open-circuiting across terminals RH and SD, the parameter operation mode is selected. With short-circuiting across terminals RH and SD, the external operation mode is selected. Switchover operation is not available during the inverter operating. |

Note : 1. In the parameter unit/external signal combined operation mode, the following signals are made valid:

| Set Value | Operation Frequency | Start Signal |
|-----------|---|--|
| 3 | Parameter unit • Direct setting and [▲]/[▼] key setting | Terminal symbol • STF • STR |
| 4 | Terminal signal • Across 2-5 0 to 5VDC • Across 2-5 0 to 10VDC • Across 4-5 4 to 20mADC • Across 1-5 0 to ±5VDC 0 to ±10VDC • Jog frequency (Pr. 15) (JOG/OH) • Multi-speed selection (Pr. 4 to 6, 24 to 27) | Parameter unit • Forward rotation key • Reverse rotation key |

- The program operation function can set operation events determining start time, rotation direction, and operation frequency for each of the three selected groups. This function enables automatic operation in accordance with the preset schedule and pattern.

This function number can also be rewritten in the external operation mode.

- With Pr. 79 set to 7, the parameter unit operation mode is prohibited as described below, depending on terminal MRS signal.

| Across terminal MRS and SD | External operation mode | Parameter operation mode |
|----------------------------|--------------------------------------|--|
| ON (close) | Output stop | Parameter unit operation mode is possible. Setting parameter is possible. |
| OFF (open) | External operation mode is possible. | Parameter unit operation mode and setting parameter are impossible. Switchover to external operation mode is forced. |

Setting Pr.11 to 8888 at external operation mode starts dc injection brake operation

Pr. 80 Pr. 81

Selecting Primary Magnetic Flux Control

Pr.80 Motor KW rating
 $HP \times .746 = KW$

Pr.81 No. of motor poles
 $Poles = \frac{120 \times F}{rpm}$

F = motor nameplate frequency
 rpm = motor nameplate base speed

- Select magnetic flux control mode operation by entering the motor KW rating in parameter 80. Enter number of motor poles in parameter 81. (factory settings of 9999 in Pr.80 and 81 selects V/Hz mode).

- Pr.71 must be set to either 20, 21, 22.
- The following conditions are required for satisfactory operation under magnetic flux control:
 - motor KW rating equal to or one size smaller than inverter constant torque KW rating.
 - number of poles equal to 2, 4, or 6.
 - one motor per inverter (will not work with multiple motors)
 - wire length between inverter and motor not to exceed 100 Ft. (30m).
 - load characteristic requires high torque with some tolerance for deviations from set frequency.

Pr. 83 Motor Rated Voltage

- Set the rated voltage for the motor in use.

Settings may be made between 0 and 1000V.

Note: Set these parameters when tuning upon selection of the auto-tuning function.

Pr. 84 Motor Rated Frequency

- Set the rated frequency for the motor in use.

Settings may be made between 50 and 1000Hz.

(Factory-set value is 60Hz)

Note: Set these parameters when tuning upon selection of the auto-tuning function.

Pr. 96 Auto-Tuning Setting/Status

- In order to operate the motor at optimum characteristics under magnetic flux vector control, the auto-tuning method may be used to measure motor constancy.

- During tuning, the Pr. 96 value will be displayed on the main monitor and level meter sections ("3" or "103" will be displayed upon normal completion, and "9" upon faulty completion).

See pg. 17 for auto-tuning operation method.

| Set value | Details |
|-----------|---------------------------------------|
| 0 | No auto-tuning (factory setting). |
| 1 | Auto-tuning when not operating motor. |
| 101 | Auto-tuning when operating motor. |

(Notes)

- When motor is connected. However, turn off motor when beginning to tune.
- Auto-tuning is possible even when load (friction, normal load, etc.) is connected to the motor.
- When selecting Pr.96 = "101" (auto-tuning when operating motor), be careful because the motor is operating.
- Tuning cannot be performed on high slip motors, high-speed motors or other special type motors.

Pr. 97 Refer to Pr.67.

Pr. 140 Refer to Pr.14.

Pr. 145 Parameter Unit Language Selection

- Allows selection of the language displayed on the FR-PU02ER/FR-ARWER four-language parameter (copy) unit (option).

| Set Value | Language Displayed |
|-----------|---------------------------|
| 0 | English (factory setting) |
| 1 | German |
| 2 | French |
| 3 | Spanish |

Note : This function is invalid when the FR-PU02, FR-PU02E or FR-ARW parameter (copy) unit used.

Pr. 155 RT Terminal Activation Timing Selection

- The operation activated timing of the second control function selection (terminal RT) may be selected.

| Pr.155 set value | Second control function operation timing |
|------------------|--|
| 0 | Activated immediately according to terminal RT ON/OFF (factory setting). |
| 10 | Activated only with terminal RT at "ON" and at constant speed. (Even with terminal RT at "ON", function not activated during acceleration/deceleration.) |

Note: "1" and "11" settings should be avoided, as they are special settings performed exclusively by the manufacturer.

Pr. 156 Stall Prevention Operation Selection

- The operation details of the stall prevention function are selected.

| Pr.156 set value | Stall prevention operation |
|------------------|--|
| 0 | Operates (factory setting). |
| 100 | Stall prevention does not operate during regenerative operation. |

- Besides the above, various setting values may be selected. For further details, refer to the operation instruction manual.

Pr. 157 Overload Alarm Signal Output Timer Setting

- The overload alarm signal may be output when the time set in Pr.157 is exceeded.

| Pr.157 set value | Output signal operation |
|------------------|--|
| 0 sec. | 0: Output according to overload (OL) operation (factory setting) |
| 0.1~25 sec. | 0.1-25: Output following set time. |
| 9999 | 9999: No overload alarm signal output. |

Pr. 158 Refer to Pr.54.

Pr. 900 Terminal FM output calibration

- The parameter unit can be used to calibrate the meter connected to the FM terminal. This calibration function is common to all monitors selected for Pr.54.
- Terminal FM has a pulse output as illustrated below. When Pr.900 is set, the parameter unit can be used to calibrate the scale of the meter connected to the inverter, eliminating the use of a calibration resistor. (For details of the calibration method, refer to the instruction manual.)

Meter type: (1 mA full-scale analog meter).

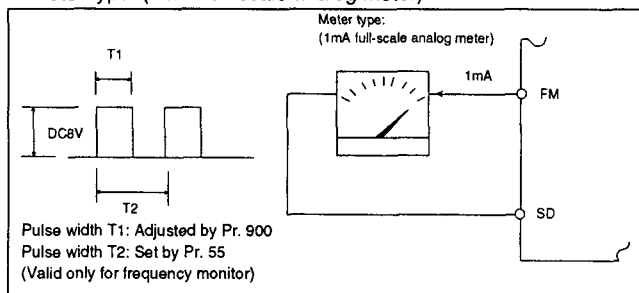

- Monitor by using the digital indicator

Pulse train output at the FM terminal can be used for digital display by the digital counter. The full-scale value described at Pr.54 provides 1440 Hz output. When you select the operation frequency from monitor items, the rate of output frequency at this FM terminal can be set for Pr.55.(Digital indicator)

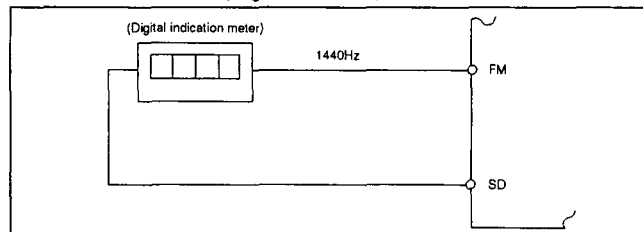

Note: The factory-set value provides the full-scale value and 1440 Hz of FM output frequency at 60 Hz and 1mA.

Pr. 901 Terminal AM output calibration

- This function is used for calibration when Pr.54 has been set to 101 - 118 (or Pr.158 has been set to 1-18) to select analog output to AM terminal. As described at Pr.54, the value has been factory-set so that 10 VDC output is obtained with each monitor item in the full-scale state. With this parameter, you can adjust the output voltage rate (gain) to graduations of the meter. Note that the maximum output voltage is 10 VDC. (For details on the calibration method, refer to the instruction manual.)

Pr.902 Pr.903 Pr.904 Pr.905

Adjusting frequency setting signal gain and bias

- Pr.902 Bias for frequency reference voltage signal
- Pr.903 Gain for frequency reference voltage signal
- Pr.904 Bias for frequency reference current signal
- Pr.905 Gain for frequency reference current signal

- You can set any value for the level of output frequency to the frequency setting signal (0 to 5 VDC, or 0 to 10 VDC, or 4 to 20 mA).

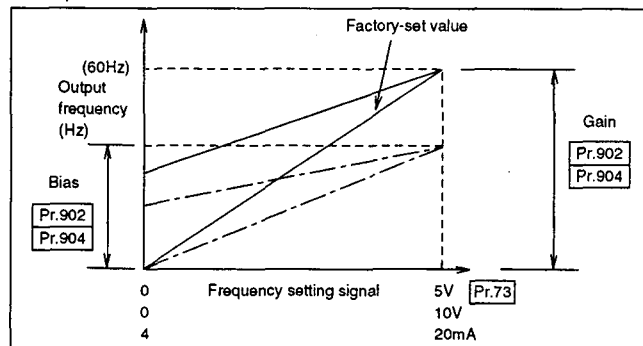

11. 2 Operation Using the Programmed Operation Function

In programmed operation, automatic operation is performed under the control of the internal timer in accordance with the desired time of day, frequency and direction of rotation set in advance.

11. 2.1. Specifications

(1) Wiring

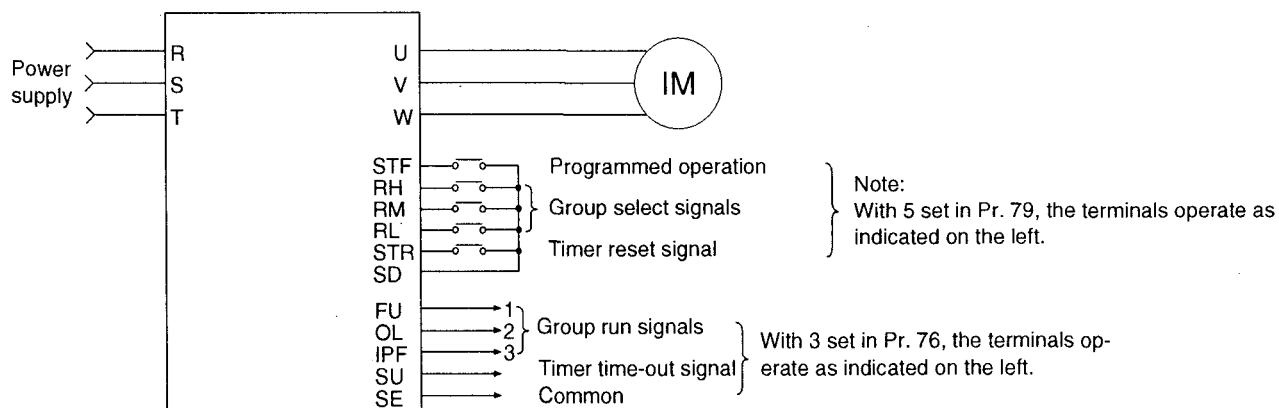

(2) Setting of the desired time of day, frequency and rotation direction

The above three items are defined as one point and every 10 points are grouped. Parameters Pr. 200 to Pr. 231 are used for this setting.

| | Setting Point | Rotation Direction, Frequency, Start Time of Day |
|---------|---------------|--|
| Group 1 | No 1 | Pr. 201 |
| | 2 | Pr. 202 |
| | 3 | Pr. 203 |
| | 4 | Pr. 204 |
| | 10 | Pr. 210 |
| Group 2 | No 11 | Pr. 211 |
| | 20 | Pr. 220 |
| Group 3 | No 21 | Pr. 221 |
| | 30 | Pr. 230 |

1) Setting the frequency and rotation direction

PU screen display

```
201 SetPRG 1
Direction 1
Set 30.00Hz
Time
```

Rotation direction—1: forward rotation, 2: reverse rotation, 3 and up: error
0: stop

Frequency—0.1Hz increments
(0 to 400Hz)

- To make a stop, write 0 in the rotation direction and frequency.
 - When no setting is made, set 9999.
- To select the time of day unit, use parameter Pr. 200 (programmed operation minute/second selection).

2) Setting the time of day

PU screen display

```
201 SetPRG 1
Direction 1
Set 30.00Hz
Time 4:30S
```

Hour Minute —in units of minutes Pr. 200 = 1, 3
Minute Second —in units of seconds Pr. 200 = 0, 2

- An error results if 1:80 is input (in excess of 59 minutes or 59 seconds).
- When no setting is made, set 9999.

3) Setting example

Operation pattern

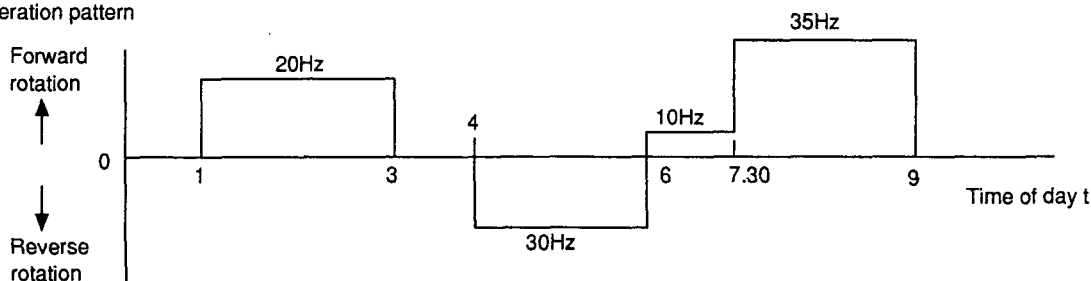

- No. 1 Forward rotation • 20Hz 1 o'clock 0 minutes → Pr. 201 1, 20, 1:00
- 2 Stop 3 o'clock 0 minutes → Pr. 202 0, 0, 3:00
- 3 Reverse rotation • 30Hz 4 o'clock 0 minutes → Pr. 203 2, 30, 4:00
- 4 Forward rotation • 10Hz 6 o'clock 0 minutes → Pr. 204 1, 10, 6:00
- 5 Forward rotation • 35Hz 7 o'clock 30 minutes → Pr. 205 1, 35, 7:30
- 6 Stop 9 o'clock 0 minutes → Pr. 206 0, 0, 9:00

- The time of day is 0 when both the start signal and group select signal are entered.
- No setting is made when either the setting or time of day is 9999.

4) Reference time of day

Programmed operation is performed under the control of the internal timer (RAM).

i) The timer range is 0 to 99.59.

When Pr. 200 = 0, max. 99 minutes 59 seconds

When Pr. 200 = 1, max. 99 hours 59 minutes

ii) Resetting the reference time of day

Cleared by the timer reset terminal, inverter reset terminal or power-off.

iii) The reference time of day can be set in PR. 231 if required.

Can be used for synchronising] to the time of day.

iv) When Pr. 200 = 2 or 3, the reference time of day is displayed instead of voltage monitor.

v) Timer accuracy

Instantaneous error $\pm 0.16s$

Accumulative error (50ppm according to the accuracy of the crystal oscillator)

MT-A independent Error of max. 4.5s per day (24Hr X 60 X 60 X 50ppm 4.32s)

(3) Input terminals

- The following terminals are made valid and invalid when programmed operation is being performed with Pr. 79 = 5 (programmed operation):

| Valid Terminals | Invalid Terminals | Terminals Used |
|-----------------|-------------------|----------------|
| RES | AU | STF |
| MRS | STOP | STR |
| RT | No. 2 | RH |
| OH | No. 4 | RM |
| | No. 1 | RL |
| | JOG | |

(4) Mode switching

When the programmed operation start signal (STF) or timer reset signal (STR) is on, switching between the PU operation mode and external operation mode cannot be made.

11. 2. 2. Detailed Description of the Functions

1) Parameters used

| No. | Name | Range | Unit | Factory Setting | Remarks |
|-------------------|---|------------------------------------|-----------------------------------|-----------------|--|
| Pr. 200 | Programmed operation Minute/second selection | 0 to 3 | 1 | 0 | 0 - minute/second unit/voltage monitor 1 - o'clock/minute unit/voltage monitor 2 - minute/second unit/reference time of day monitor 3 - o'clock/minute unit/reference time of day monitor |
| Pr. 201 to 230 | Programmed operation Program setting | 0 to 2 0 to 400Hz 0 to 99:59 | 1 0.1Hz Minute or second | 9999 | Rotation direction 0 - stop, 1 - forward rotation, 2 - reverse rotation Set frequency Time of day 9999 : no setting |
| Pr. 231 | Timer setting | 0 to 99:59 | | 0 | Current timer time-of-day setting (RAM) |

- * When the setting of Pr. 200 has been changed independently, the units of Pr. 231 and Pr. 201 to 230 change.

The numerals do not change.

- * When 2 or 3 is set in Pr. 200, the reference time-of-day monitor screen is displayed instead of the voltage monitor screen.

2) Input signals

| Name | Description | Signal Level | Remarks |
|--|--|-----------------------|--|
| Group select signal RH, RM, RL | Used to select the group for programmed operation. | Photocoupler isolated | May also be driven by transistor. When $i_c = 10\text{mA}$, $V_{ec} < 0.5\text{V}$ should be satisfied. |
| Timer reset signal STR | Input to zero the reference time of day. | Photocoupler isolated | |
| Programmed operation start signal STF | Input to start programmed operation. | Photocoupler isolated | |

3) Output signals

| Name | Description | Signal Level | Remarks |
|---|---|-------------------------------------|---------------------------------|
| Time-out signal Inverter terminal (SU) | Output on completion of the operation of the selected group and cleared on timer reset. | Open collector output (isolated) | Permissible load 24VDC, 0.1A |
| Group select signal Inverter terminal (FU, OL, IPF) | Output during operation of corresponding group's program and cleared on timer reset. | Open collector output (isolated) | Permissible load 24VDC, 0.1A |

Only when
Pr. 76 = 3

11. 2. 3. Operation Procedure

- (1) After completion of the settings in accordance with 1, turn on the desired group select signal (for example, connect RH-SD for group 1) and then turn on the start signal (STF). This causes the internal timer (reference time of day) to be reset automatically and the operation of that group to be performed in sequence in accordance with the settings. When the operation of the group ends, a signal is output from the time-out output terminal. (The open collector signal of SU is turned on.)

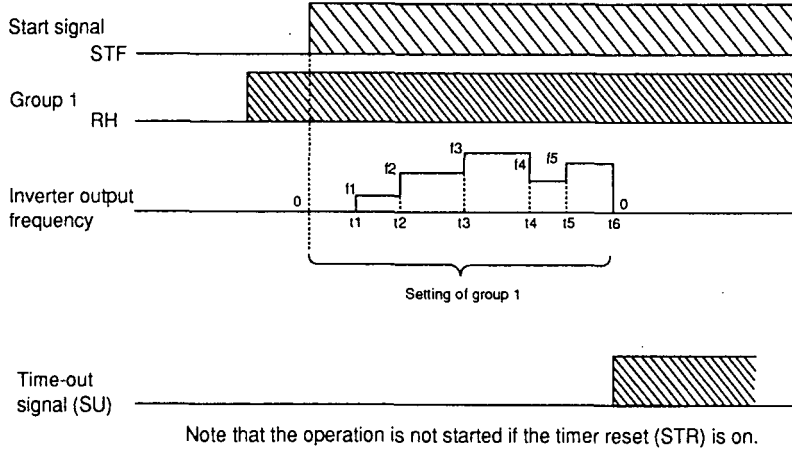

- (2) Use the programmed operation function with 5 set in Pr. 79. If any of the group select signals is turned on during PU operation or data link operation, time scheduled operation is not carried out.
- (3) If two groups are selected at the same time, the operations of the selected groups are executed in sequence of group 1, group 2 and group 3. For example, if group 1 and group 2 have been selected, the operation of group 1 is first carried out, and after that operation ends, the reference time of day is reset, the operation of group 2 is started, and the time-out signal (SU) is output after the operation of group 2 ends.

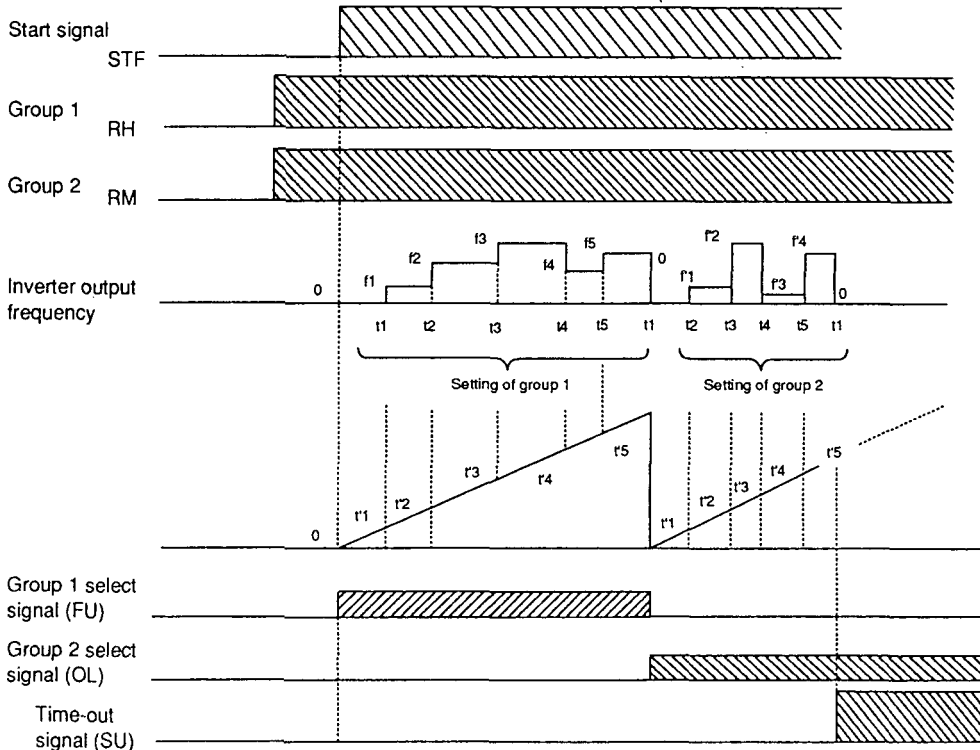

(4) To repeat the operation of the same group, reset the timer using the time-out signal as shown below.

- 1) To repeat the operation of only group 1 2) To repeat the operation of groups 1 and 2

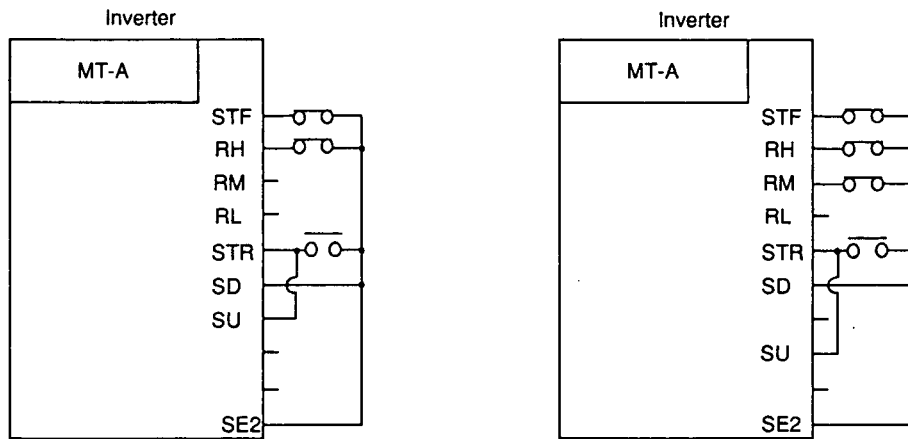

Note: If the inverter is powered down, then up (including instantaneous power failure) during the execution of the programmed operation, the inverter is brought to a stop after the power is restored. To resume the operation, turn the start signal off, then on again.

11. 3 5-Point Flexible V/F Characteristic

The V/F characteristic can be changed by linear interpolation made between five points set from V/F1 to V/F5.

■ Operation

An optional V/F characteristic can be set by setting V/F1 (first frequency) (first frequency voltage), V/F2, V/F3, V/F4 and V/F5 from the parameter unit in advance.

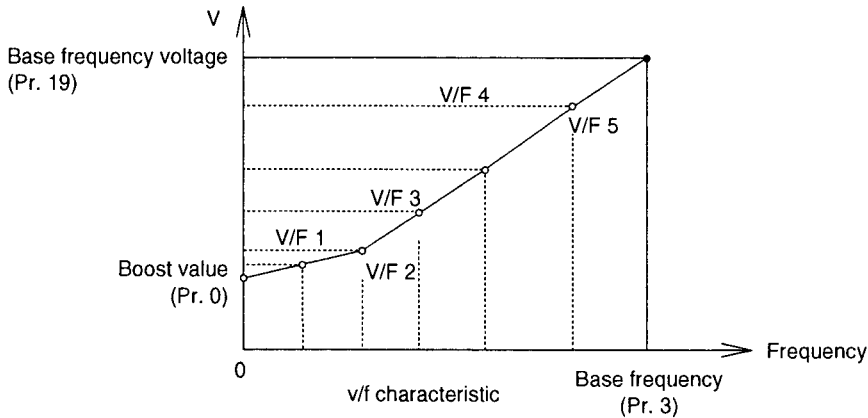

■ Adjustment

- Set 2 in Pr. 71 from the parameter unit. (When Pr. 71 = 0 or 1, the standard V/F characteristic is provided.)
- Set the desired frequencies and voltages in Pr. 100 to Pr. 109.

The setting must satisfy the following relationship: $F1 \neq F2 \neq F3 \neq F4 \neq F5 \neq \text{base frequency}$ if the set frequencies are the same, a write error occurs.

- If "9999" is set in any frequency, it is ignored.

■ Notes

- (1) The V/F 5-point flexible characteristic functions for V/F control only.
- (2) The V/F 5-point flexible characteristic does not function when Pr. 60 (intelligent mode selection) is selected.
- (3) The base frequency voltage may be set optionally between 0 and 1000V, but output voltage is clamped at the base frequency voltage if output frequency is beyond the base frequency.
- (4) Pr. 19 (base frequency voltage) must be set. (When Pr. 19 = 9999, Pr. 71 cannot be set to 2.)
- (5) If "2" is set in Pr. 71, Pr. 47 (second V/F (base frequency)) does not function.
- (6) When "2" is set in Pr. 71, the electronic overcurrent protection is calculated as a general-purpose motor.

■ V/F1 to 5 adjustment (setting) range

| Parameter No. | Applicable Motor Selection (Pr. 71) ≠ 2 | | Applicable Motor Selection (Pr. 71) = 2 | | | |
|---------------|---|------------------|---|------------------------|--------------------|-----------------|
| | Function Name | Setting range | Function Name | Setting range (Note 2) | Minimum Increments | Factory setting |
| Pr. 107 | BCD input (offset) | 0 to 400Hz | V/F1 (first frequency) | 0 to 400Hz, 9999 | 0.01 | 9999 |
| 108 | BCD input (gain) | 0 to 400Hz, 9999 | V/F1 (first frequency voltage) | 0 to 1000V | 0.1 | 0 |
| 109 | Binary input (offset) | 0 to 400Hz | V/F2 (second frequency) | 0 to 400Hz, 9999 | 0.01 | 9999 |
| 110 | Binary input (gain) | 0 to 400Hz, 9999 | V/F2 (second frequency voltage) | 0 to 1000V | 0.1 | 0 |
| 111 | BCD/binary selection | 0, 1, 2, 3, 9999 | V/F3 (third frequency) | 0 to 400Hz, 9999 | 0.01 | 9999 |
| 112 | Speed feedback range | 0 to 400Hz, 9999 | V/F3 (third frequency voltage) | 0 to 1000V | 0.1 | 0 |
| 113 | Feedback gain | 0 to 100 | V/F4 (fourth frequency) | 0 to 400Hz, 9999 | 0.01 | 9999 |
| 114 | Stop position command selection | 0, 1, 9999 | V/F4 (fourth frequency voltage) | 0 to 1000V | 0.1 | 0 |
| 115 | Orientation speed | 0 to 30Hz | V/F5 (fifth frequency) | 0 to 400Hz, 9999 | 0.01 | 9999 |
| 116 | Creep speed | 0 to 10Hz | V/F5 (fifth frequency voltage) | 0 to 1000V | 0.1 | 0 |

11. 4 PU Disconnection Detection Function

This function detects that the parameter unit (PU) has been disconnected from the inverter and brings the inverter to an alarm stop.

■ Operation

When the PU disconnection detection function is selected from the parameter unit, this function detects that the PU has been disconnected from the inverter and brings the inverter to an alarm stop.

| Function Number | Function Name | Setting Range | Factory Setting | Description |
|-----------------|-----------------|---------------|-----------------|--|
| 75 | Reset selection | 0, 1, 2, 3 | 0 | 0 : Reset input normally enabled. PU disconnection is not detected. 1 : Reset input enabled only when protective function is activated. PU disconnection is not detected. 2 : Reset input normally enabled. PU disconnection is detected. 3 : Reset input enabled only when protective function is activated. PU disconnection is detected. |

* When the inverter comes to an alarm stop, the alarm messages displayed are PU DISCONNECTED (PU) and E.PUE (inverter LED).

■ Notes

1. Alarm does not occur if the PU has been disconnected from initial start.
2. This disconnection detection function judges that the PU is disconnected when the PU is removed for more than 1 second.
3. When the FR-PU01 is used, this function can also be used but its alarm display is E. PE.
4. To resume operation, reset the inverter after checking that the PU is connected securely.

11. 5 Auto Commission

If the motor used is not Mitsubishi's standard motor or Mitsubishi's constant-torque motor, the auto tuning function allows the motor to be run with optimum operation characteristics under magnetic flux vector control.

Also, commission data (motor constants) can be copied to the other inverter by the FR-ARWE parameter copy unit.

Note that a special motor, e.g. a high-slip motor or a high-speed motor, cannot be tuned. Also, the maximum speed is up to 120Hz.

<Operation procedure>

1. Checking the wiring and load

Before performing auto commission, check the following:

- (1) The motor is connected. However, the motor must be at a stop at the start of tuning.
- (2) Auto tuning can be performed if the motor is connected with a load (e.g. friction, steady load). Note that as the load is smaller, commission accuracy is higher. Also note that if inertia is large, commission accuracy remains unchanged.
- (3) When "101" (auto commission is performed with the motor rotated) has been set in Pr.96 (auto tuning setting/state), note the following:
 - 1) Enough torque is not provided during commission.
 - 2) There should be no problem if the motor is run at about the rated motor frequency (set value of Pr.84).
 - 3) The brake is released.
 - 4) No force is applied to rotate the motor.
- (4) If "1" (tuning without motor rotating) is set in Pr.96, the motor may run slightly.

Therefore, make tuning after fixing the motor securely with a mechanical brake or ensuring that motor rotation will not compromise safety.

Note that slight rotation of the motor will not affect the tuning performance.

- (5) Auto tuning is not performed properly when the optional sine wave filter (MT-BSC/BSC) is connected between the inverter and the motor. Disconnect it before starting auto tuning.

2. Selection of magnetic flux vector control

Select the magnetic flux vector control in accordance with page 59.

3. Setting of parameters

Set the following parameters in accordance with the parameter settings on this page.

- (1) Pr.96 "auto tuning setting/state" Set "1" or "101".
 - Set value"1" Commissioned without the motor rotated.
 - Set value"101" Commissioned with the motor rotated.
- (2) Pr.83 "rated motor voltage" Set the rated motor voltage (V).
- (3) Pr.84 "rated motor frequency" Set the rated motor frequency (Hz).

(4) Pr.71 “applied motor” Select the set value in accordance with the following table:

- Standard motor Set “3”.
- Constant-torque motor .. Set “13”.

Note: Pr.83 and Pr.84 are displayed only when magnetic flux vector control has been selected (Pr.80, Pr.81). Set these parameters according to the rating plate of the motor. When there are two or more rated values for a standard motor, etc., set 200V/60Hz of 400V/60Hz.

■ Parameter settings

| Parameter Number | Name | Setting Range | Set Value | Description | Factory Setting | | |
|------------------|---------------------------|----------------------|-----------------------|---|---|---|--|
| 71 | Applied motor *1 | 0 to 6, 13 to 16, 20 | 0 | Standard motor (more than 1.5kW) | - | | |
| | | | 1 | Constant-torque motor | | | |
| | | | 2 | Standard motor (5-point flexible V/F characteristic) | | | |
| | | | 20 | Standard motor (1.5kW or less) | | | |
| | | | 3 | Standard motor | | “Auto tuning setting” is selected | |
| | | | 13 | Constant-torque motor | | | |
| | | | 4 | Standard motor | | Auto tuning data read/change setting is enabled | |
| | | | 14 | Constant-torque motor | | | |
| | | | 5 | Standard motor | | Star connection | Direct input of motor constants is enabled |
| | | | 15 | Constant-torque motor | | | |
| 6 | Standard motor | Delta connection | | | | | |
| 16 | Constant-torque motor | | | | | | |
| 83 | Rated motor voltage | 0 to 1000V | 0 to 1000V | “No auto commission” is selected. Rated motor voltage (V) is set. | 200 | | |
| 84 | Rated motor frequency | 50 to 120Hz | 50 to 120Hz | Rated motor frequency (Hz) is set. | 60 | | |
| 90 | Motor constant R1 | 9999, 0 to 10,000Ω | 9999 0 to 10,000Ω | Tuning data *2 | 0 - | | |
| 91 | Motor constant R2 | 9999, 0 to 10,000Ω | 9999 0 to 10,000Ω | | 0 - | | |
| 92 | Motor constant L1 | 9999, 0 to 1000.0mH | 9999 0 to 1000.0mH | | 0 - | | |
| 93 | Motor constant L2 | 9999, 0 to 1000.0mH | 9999 0 to 1000.0mH | | 0 - | | |
| 94 | Motor constant χ | 9999, 0 to 1000% | 9999 0 to 1000% | | 0 - | | |
| 96 | Auto tuning setting/state | 0, 1, 101 *3 | 0 | | “No auto commission” is selected. | 0 | |
| | | | 1 | | Auto commission is performed without the motor rotated. | - | |
| | | | 101*3 | Auto commission is performed with the motor rotated. | - | | |

*1: The electronic overcurrent protection characteristic is selected at the same time.

*2: The values measured by auto tuning are set automatically.

*3: Select “101” to increase tuning accuracy.

4. Switching the auto commission command ON

In the PU operation mode, press the [FWD] or [REV] key.
 In the external operation mode, turn on the start switch (connect terminals across STF or STR-P24).

Note: 1. When "101" is set in Pr.96, be careful to avoid hazard because the motor rotates.
 2. During auto commission, the input terminals are made valid/invalid as indicated below:

| Valid Terminals | Invalid Terminals |
|--|---------------------------|
| STOP OH MRS RT, JOG, CS RES STF/STR | RH/RM/RL 2, 1, 4 AU |

●To force the motor to stop during tuning
 Terminate commission using any of the MRS terminal, RES terminal and [STOP] key.

5. Commission state monitoring

During commissioning, the value of Pr.96 is displayed on the main monitor and level meter of the PU as indicated below. As on the PU, 1, 2, 3, 8, 9, 102 or 103 is shown on the inverter LED.
 (When Pr.51 = "1" (factory setting))

●PU main monitor

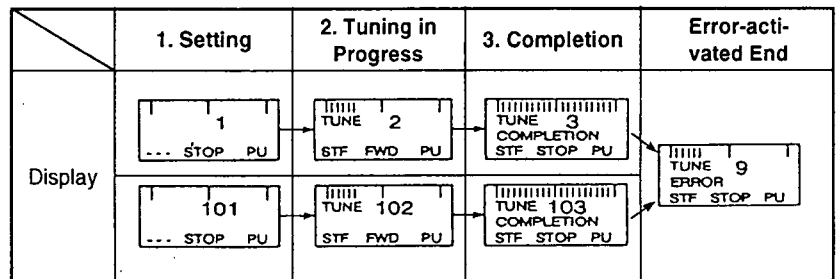

●PU level meter

Indicates tuning progress with 0% (start) to full-scale 100% (end).

●Inverter LED

| | 1. Setting | 2. Tuning in Progress | 3. Completion | Error-activated End |
|-----------------|------------|-----------------------|---------------|---------------------|
| Displayed value | 0 | 2 | 3 | 9 |
| | 101 | 102 | 103 | |

6. Auto commission end

Check the value of Pr.96.

- Normal end "3" or "103" is displayed.
- Forced end "8" is displayed.
- Error-activated end "9" is displayed.

When commission came to a normal end in the PU operation mode, press the [STOP] key. When in the external operation mode, turn off the start switch (disconnect terminals STF or STR-P24). This operation resets auto commission and returns the PU monitor to an ordinary display.

Note that if this operation is not performed, next operation cannot be started.
 When tuning resulted in an error-activated end (Pr.96 value = 9) or a forced end (Pr.96 value = 8), auto tuning did not come to a normal end and the motor constant was not set. In this case, reset the inverter (see page 69) and restart from operation step 1.

[Optional Setting of Motor Constants]

The motor constants (Pr.90 to 94) may either be set as appropriate by reading and changing the data measured by auto commission, or without using the auto commission data:

■ Setting the motor constants by reading and changing the auto commission data

<Operation procedure>

1. Change the set value of Pr.77 "parameter write disable selection" to "801". Only when the settings of Pr.80 and Pr.81 are other than "9999", the parameters of the motor constants (Pr.90 to 94) can be displayed. Though the parameters (Pr.82 to 99) other than the motor constants (Pr.90 to 94) may also be displayed, they are to be set by the manufacturer and must therefore be set carefully without misoperation.
2. Set Pr.71 "applied motor" as indicated below:
Standard motor: Set "4". Constant-torque motor: Set "14".
3. In the parameter setting mode, read the following parameters and set the required values (Note 1):

| Parameter Number | Name | Setting Range (Note 4) | Minimum Setting Increment | Factory Setting |
|------------------|-------------------------|------------------------|---------------------------|-----------------|
| Pr.90 | Motor constant R1 | 0 to ****, 9999 | 1 | 9999 |
| Pr.91 | Motor constant R2 | 0 to ****, 9999 | 1 | 9999 |
| Pr.92 | Motor constant L1 | 0 to ****, 9999 | 1 | 9999 |
| Pr.93 | Motor constant L2 | 0 to ****, 9999 | 1 | 9999 |
| Pr.94 | Motor constant δ | 0 to ****, 9999 | 1 | 9999 |

4. Return the setting of Pr.77 to the original value.

Note: 1. Only when the settings of Pr.80 and Pr.81 are other than "9999" (magnetic flux vector control is selected), Pr.90 to 94 can be read.
2. Set "9999" in Pr.90 to 94 to use the standard motor constants (including the constant-torque motor).
3. Set "3" (standard motor) or "13" (constant-torque motor) in Pr.71 to use the motor constants measured by auto tuning. If "4" or "14" has been set in Pr.71 and the motor constants changed, the original data measured by auto commission remain changed.
4. The motor constants measured by auto tuning have been converted into internal data (****).
When setting the motor constants, see the following setting example:
Setting example: When the Pr.90 "motor constant R1" value displayed is 2516 and it is desired to increase the Pr.90 value slightly (5%), set 2642 (i.e. $2516 \times 1.05 = 2641.8$) in Pr.90. (The value displayed has been converted into internal data for internal use. Hence, there is no significance if an optional value is simply added to the displayed value.)

■ **Setting the motor constants without using the auto commission data**

The motor constants of Pr.92 and 93 may either be entered in [Ω] or [mH]. Check the unit of the motor constants before starting the setting operation.

● **Entering the motor constants of Pr.92 and 93 in [Ω]**

<Operation procedure>

1. Change the set value of Pr.77 "parameter write disable selection" to "801". Only when the settings of Pr.80 and Pr.81 are other than "9999", the parameters of the motor constants (Pr.90 to 94) can be displayed. Though the parameters (Pr.82 to 99) other than the motor constants (Pr.90 to 94) may also be displayed, they are to be set by the manufacturer and must therefore be set carefully without misoperation.
2. Set Pr.71 "applied motor" as indicated below:

| | | Star Connection Motor | Delta Connection Motor |
|-----------|-----------------------|-----------------------|------------------------|
| Set value | Standard motor | 5 | 6 |
| | Constant-torque motor | 15 | 16 |

3. In the parameter setting mode, read the following parameters and set the required values:

| Pr.No. | Name | Setting Range | Minimum Setting Increment | Factory Setting |
|--------|-------------------|--------------------------|---------------------------|-----------------|
| Pr.90 | Motor constant r1 | 0 to 10 Ω , 9999 | 0.001 Ω | 9999 |
| Pr.91 | Motor constant r2 | 0 to 10 Ω , 9999 | 0.001 Ω | 9999 |
| Pr.92 | Motor constant x1 | 0 to 10 Ω , 9999 | 0.001 Ω | 9999 |
| Pr.93 | Motor constant x2 | 0 to 10 Ω , 9999 | 0.001 Ω | 9999 |
| Pr.94 | Motor constant xm | 0 to 500 Ω , 9999 | 0.01 Ω | 9999 |

4. Set Pr.84 "rated motor frequency" with reference to the following table:

| Pr.No. | Name | Range | Increment | Factory Setting |
|--------|-----------------------|-------------------|-----------|-----------------|
| Pr.84 | Rated motor frequency | 50 to 120Hz, 9999 | 0.01Hz | 9999 |

5. Return the setting of Pr.77 to the original value.

Note: 1. Only when the settings of Pr.80 and Pr.81 are other than "9999" (magnetic flux vector control is selected), Pr.90 to 94 can be read.
 2. Set "9999" in Pr.90 to 94 to use the standard motor constants (including the constant-torque motor).
 3. If the "star connection" or "delta connection" selected in Pr.71 does not match the actual motor, proper magnetic flux vector control will not be carried out.

● **Entering the motor constants of Pr.92 and 93 in [mH]**

<Operation procedure>

1. Change the set value of Pr.77 "parameter write disable selection" to "801". Only when the settings of Pr.80 and Pr.81 are other than "9999", the parameters of the motor constants (Pr.90 to 94) can be displayed. Though the parameters (Pr.82 to 99) other than the motor constants (Pr.90 to 94) may also be displayed, they are to be set by the manufacturer and must therefore be set carefully without misoperation.
2. Set Pr.71 "applied motor" as indicated below:
Standard motor: Set "0".
Constant-torque motor: Set "1".
3. In the parameter setting mode, read the following parameters and set the required values:

| Pr.No. | Name | Setting Range | Minimum Setting Increment | Factory Setting |
|--------|-------------------------|-------------------|---------------------------|-----------------|
| Pr.90 | Motor constant R1 | 0 to 10Ω, 9999 | 0.001Ω | 9999 |
| Pr.91 | Motor constant R2 | 0 to 10Ω, 9999 | 0.001Ω | 9999 |
| Pr.92 | Motor constant L1 | 0 to 1000mH, 9999 | 0.1mH | 9999 |
| Pr.93 | Motor constant L2 | 0 to 1000mH, 9999 | 0.1mH | 9999 |
| Pr.94 | Motor constant γ | 0 to 100%, 9999 | 0.1% | 9999 |

4. Set Pr.84 "rated motor frequency" with reference to the following table:

| Pr.No. | Name | Range | Increment | Factory Setting |
|--------|-----------------------|-------------------|-----------|-----------------|
| Pr.84 | Rated motor frequency | 50 to 120Hz, 9999 | 0.01Hz | 9999 |

5. Return the setting of Pr.77 to the original value.

Note: 1. Only when the settings of Pr.80 and Pr.81 are other than "9999" (magnetic flux vector control is selected), Pr.90 to 94 can be read.
2. Set "9999" in Pr.90 to 94 to use the standard motor constants or constant-torque motor constants.

11. 6 Selection of the Stall Prevention Function

By setting Pr.156, stall prevention (overcurrent stall prevention) can be disabled and the OL signal output delayed.



| Pr.156 Set Value | While stall prevention output voltage is reduced. <input type="radio"/> ... output voltage is reduced. <input type="radio"/> ... output voltage is not reduced <input checked="" type="radio"/> ... output voltage is reduced. | Stall Prevention Selection | | | OL Signal Output <input type="radio"/> ... Operation continued <input checked="" type="radio"/> ... Operation not continued * | Factory Setting |
|---------------------|---|--|----------------------------------|----------------------------------|---|-----------------|
| | | ○ ... Activated ● ... Not activated | | | | |
| | | During acceleration | During constant speed | During deceleration | | |
| 0 | <input type="radio"/> | <input type="radio"/> | <input type="radio"/> | <input type="radio"/> | <input type="radio"/> | 0 |
| 1 | <input checked="" type="radio"/> | <input type="radio"/> | <input type="radio"/> | <input type="radio"/> | <input type="radio"/> | |
| 2 | <input type="radio"/> | <input checked="" type="radio"/> | <input type="radio"/> | <input type="radio"/> | <input type="radio"/> | |
| 3 | <input checked="" type="radio"/> | <input checked="" type="radio"/> | <input type="radio"/> | <input type="radio"/> | <input type="radio"/> | |
| 4 | <input type="radio"/> | <input type="radio"/> | <input checked="" type="radio"/> | <input type="radio"/> | <input type="radio"/> | |
| 5 | <input checked="" type="radio"/> | <input type="radio"/> | <input checked="" type="radio"/> | <input type="radio"/> | <input type="radio"/> | |
| 6 | <input type="radio"/> | <input checked="" type="radio"/> | <input checked="" type="radio"/> | <input type="radio"/> | <input type="radio"/> | |
| 7 | <input checked="" type="radio"/> | <input checked="" type="radio"/> | <input checked="" type="radio"/> | <input type="radio"/> | <input type="radio"/> | |
| 8 | <input type="radio"/> | <input type="radio"/> | <input type="radio"/> | <input checked="" type="radio"/> | <input type="radio"/> | |
| 9 | <input checked="" type="radio"/> | <input type="radio"/> | <input type="radio"/> | <input checked="" type="radio"/> | <input type="radio"/> | |
| 10 | <input type="radio"/> | <input checked="" type="radio"/> | <input type="radio"/> | <input checked="" type="radio"/> | <input type="radio"/> | |
| 11 | <input checked="" type="radio"/> | <input checked="" type="radio"/> | <input type="radio"/> | <input checked="" type="radio"/> | <input type="radio"/> | |
| 12 | <input type="radio"/> | <input type="radio"/> | <input checked="" type="radio"/> | <input checked="" type="radio"/> | <input type="radio"/> | |
| 13 | <input checked="" type="radio"/> | <input type="radio"/> | <input checked="" type="radio"/> | <input checked="" type="radio"/> | <input type="radio"/> | |
| 14 | <input type="radio"/> | <input checked="" type="radio"/> | <input checked="" type="radio"/> | <input checked="" type="radio"/> | <input type="radio"/> | |
| 15 | <input checked="" type="radio"/> | <input checked="" type="radio"/> | <input checked="" type="radio"/> | <input checked="" type="radio"/> | <input type="radio"/> | |
| 16 | <input type="radio"/> | <input type="radio"/> | <input type="radio"/> | <input type="radio"/> | <input checked="" type="radio"/> | |
| 17 | <input checked="" type="radio"/> | <input type="radio"/> | <input type="radio"/> | <input type="radio"/> | <input checked="" type="radio"/> | |
| 18 | <input type="radio"/> | <input checked="" type="radio"/> | <input type="radio"/> | <input type="radio"/> | <input checked="" type="radio"/> | |
| 19 | <input checked="" type="radio"/> | <input checked="" type="radio"/> | <input type="radio"/> | <input type="radio"/> | <input checked="" type="radio"/> | |
| 20 | <input type="radio"/> | <input type="radio"/> | <input checked="" type="radio"/> | <input type="radio"/> | <input checked="" type="radio"/> | |
| 21 | <input checked="" type="radio"/> | <input type="radio"/> | <input checked="" type="radio"/> | <input type="radio"/> | <input checked="" type="radio"/> | |
| 22 | <input type="radio"/> | <input checked="" type="radio"/> | <input checked="" type="radio"/> | <input type="radio"/> | <input checked="" type="radio"/> | |
| 23 | <input checked="" type="radio"/> | <input checked="" type="radio"/> | <input checked="" type="radio"/> | <input type="radio"/> | <input checked="" type="radio"/> | |
| 24 | <input type="radio"/> | <input type="radio"/> | <input type="radio"/> | <input checked="" type="radio"/> | <input checked="" type="radio"/> | |
| 25 | <input checked="" type="radio"/> | <input type="radio"/> | <input type="radio"/> | <input checked="" type="radio"/> | <input checked="" type="radio"/> | |
| 26 | <input type="radio"/> | <input checked="" type="radio"/> | <input type="radio"/> | <input checked="" type="radio"/> | <input checked="" type="radio"/> | |
| 27 | <input checked="" type="radio"/> | <input checked="" type="radio"/> | <input type="radio"/> | <input checked="" type="radio"/> | <input checked="" type="radio"/> | |
| 28 | <input type="radio"/> | <input type="radio"/> | <input checked="" type="radio"/> | <input checked="" type="radio"/> | <input checked="" type="radio"/> | |
| 29 | <input checked="" type="radio"/> | <input type="radio"/> | <input checked="" type="radio"/> | <input checked="" type="radio"/> | <input checked="" type="radio"/> | |
| 30 | <input type="radio"/> | <input checked="" type="radio"/> | <input checked="" type="radio"/> | <input checked="" type="radio"/> | <input checked="" type="radio"/> | |
| 31 | <input checked="" type="radio"/> | <input checked="" type="radio"/> | <input checked="" type="radio"/> | <input checked="" type="radio"/> | <input checked="" type="radio"/> | |
| 100 | D | <input type="radio"/> | <input type="radio"/> | <input type="radio"/> | <input type="radio"/> | |
| | R | <input checked="" type="radio"/> | <input checked="" type="radio"/> | <input checked="" type="radio"/> | <input type="radio"/> | |

D: Driving R: Regenerative

Note: 1. When "Operation not continued at the time of OL signal output" has been selected, the "E.OLT" alarm code (stop by stall prevention) is displayed and operation stopped.

12. MAINTENANCE AND INSPECTION

The transistorized inverter is a static unit consisting mainly of semiconductor devices. Daily inspection must be performed to prevent any fault from occurring due to adverse influence by the installation environment, such as temperature, humidity, dust, dirt and vibration, changes in the parts with time, service life, and other factors.

12.1 Precautions for Maintenance and Inspection

- (1) The operator must check power on/off by himself to prevent any person not in charge from misoperating the inverter.
- (2) For some short time after the power is switched off, the capacitor remains charged at a high voltage. Before performing any inspection, make sure that the charge lamp on the printed circuit is off and check that the voltage across the main circuit terminals P and N of the inverter is 30VDC or less using a tester, etc. (For the location of the charge lamp, see the terminal block arrangement on page 115.)

12.2 Check Items

Have a proper understanding of the definitions of power and alarm indications provided for the inverter. Also, have a proper understanding of the settings of electronic overcurrent protection, etc.

(1) Daily inspection

Check for the following:

- (a) Motor operation fault
- (b) Improper installation environment
- (c) Cooling system fault
- (d) Unusual vibration and noise
- (e) Unusual overheat and discoloration

During operation, check the inverter I/O voltages using a tester.

(2) Periodic maintenance and inspection

Check the areas inaccessible during operation and requiring periodic inspection.

- (a) Cooling system: Clean the air filter, etc.
- (b) Screws and bolts: Check that they are securely tightened and retighten as necessary.
- (c) Conductors and insulating materials: Check for corrosion and damage.
- (d) Insulation resistance: Measure.
- (e) Cooling fan, smoothing capacitor, relay: Check and change if necessary.

(3) Insulation resistance test using megger

- (a) Before performing the insulation resistance test using a megger on the external circuit, disconnect the cables from all terminals of the inverter so that the test voltage is not applied to the inverter.
- (b) For the inverter, conduct the insulation resistance test on the main circuit only as shown in Fig. 12.1 and do not perform the test on the control circuit. (Use a 500VDC megger.)
- (c) For the continuity test of the control circuit, use a tester (high resistance range) and do not use the megger or buzzer.

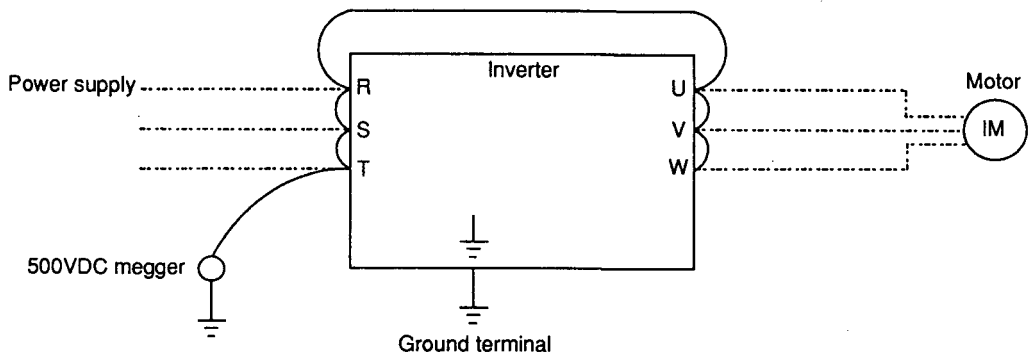

Fig. 12.1 Insulation Resistance Test Using Megger

Table 1 Daily and Periodic Inspection

| Area of inspection | Inspection Item | Description | Interval | | | Method | Criterion | Instrument |
|--------------------|---------------------------------------|--|---|----------|--------|--|---|---|
| | | | Daily | Periodic | | | | |
| | | | | 1-year | 2-year | | | |
| General | Surrounding environment | Check ambient temperature, humidity, dust, dirt, etc. | ○ | | | See note on p. 7. | Ambient temperature: -10°C to +50°C, non-freezing. Ambient humidity: 90% or less, non-condensing. | Thermometer, hygrometer, recorder |
| | Overall unit | Check for unusual vibration and noise. | ○ | | | Visual and auditory check | No fault. | |
| | Power supply voltage | Check that main circuit voltage is normal. | ○ | | | Measure voltage across inverter terminals R-S-T. | 170 to 253V (323 to 506V) 50Hz 170 to 242V (323 to 506V) 60Hz | Tester, digital multimeter |
| Main circuit | General | (1) Check with megger (across main circuit terminals and ground terminal). (2) Check for loose screws and bolts. (3) Check for overheat on each part. (4) Clean | | ○ | ○ | (1) Disconnect all cables from inverter and measure across terminals R, S, T, U, V, W and ground terminal with megger. (2) Retighten. (3) Visual check. | (1) 5M or more (2), (3) No fault | DC 500V class megger |
| | Conductors, cables | (1) Check conductors for distortion. (2) Check cable sheaths for breakage. | | ○ | | (1), (2) Visual check | (1), (2) No fault. | |
| | Terminal block | Check for damage. | | ○ | | Visual check | No fault | |
| | Inverter module Converter module | Check resistance across terminals. | | | ○ | Disconnect cables from inverter and measure across terminals R, S, T and P, N, and across U, V, W and P, N with tester x 1 range. | (See p. 81.) | Analog tester |
| | Smoothing capacitor | (1) Check for liquid leakage. (2) Check for safety valve projection and bulge. (3) Measure electrostatic capacity. | ○ | | ○ | (1), (2) Visual check (3) Measure with capacity meter. | (1), (2) No fault (3) 85% or more of rated capacity. | Capacity meter |
| | Relay | (1) Check for chatter during operation. (2) Check timer operation time. (3) Check for rough surface on contacts. | | ○ | | (1) Auditory check (2) Length of time from power on to relay on. (3) Visual check | (1) No fault (2) Relay should be switched on in 0.1 to 0.15 seconds. (3) No fault. | Universal counter |
| | Resistor | (1) Check for crack in resistor insulation. (2) Check for open cable. | | ○ | | (1) Visual check. Cement resistor, wire-wound resistor. (2) Disconnect one end and measure with tester. | (1) No fault. (2) Error should be within 10% of indicated resistance value. | Tester, digital multimeter |
| | Control circuit Protective circuit | Operation check | (1) Check balance of output voltages across phases with inverter operated independently. (2) Perform sequence protective operation test to make sure of no fault in protective and display circuits. | | ○ | | (1) Measure voltage across inverter output terminals U-V-W. (2) Simultaneously connect inverter protective circuit output terminals. | (1) Phase-to phase voltage balance within 4V for 200V (8V for 400V). (2) Fault must occur because of sequence. |
| Cooling system | Cooling fan | (1) Check for unusual vibration and noise. (2) Check for loose connection. | ○ | | | (1) Turn by hand with power off. (2) Retighten. | (1) Smooth rotation. (2) No fault. | |
| Display | Display | (1) Check for LED lamp blown. (2) Clean. | ○ | | | (1) Lamps indicate indicator lamps on panel. (2) Clean with rag. | (1) Check that lamps are lit. | |
| | Meter | Check that reading is normal. | ○ | | | (1) Check reading of meters on panel. | (1) Must satisfy specified and management values. | Voltmeter, ammeter, etc. |
| Motor | General | (1) Check for unusual vibration and noise (2) Check for unusual odor. | ○ | | | (1) Auditory, sensory, visual checks. (2) Check for unusual odor due to overheat, damage, etc. | (1), (2) No fault | |
| | Insulation resistance | (1) Check with megger (across terminals and ground terminal) | | | ○ | (1) Disconnect cables from U, V, W, including motor cables. | (1) 5M or more. | 500V megger |

12.3 Measurement of Main Circuit Voltages, Currents and Powers

(1) Measurement of voltages and currents

Since the voltages and currents on the inverter power supply and output sides include harmonics, accurate measurement depends on the instruments used and circuits measured.

When instruments for commercial frequency are used for measurement, measure the circuits in Fig. 12.2 using the instruments in Table 2.

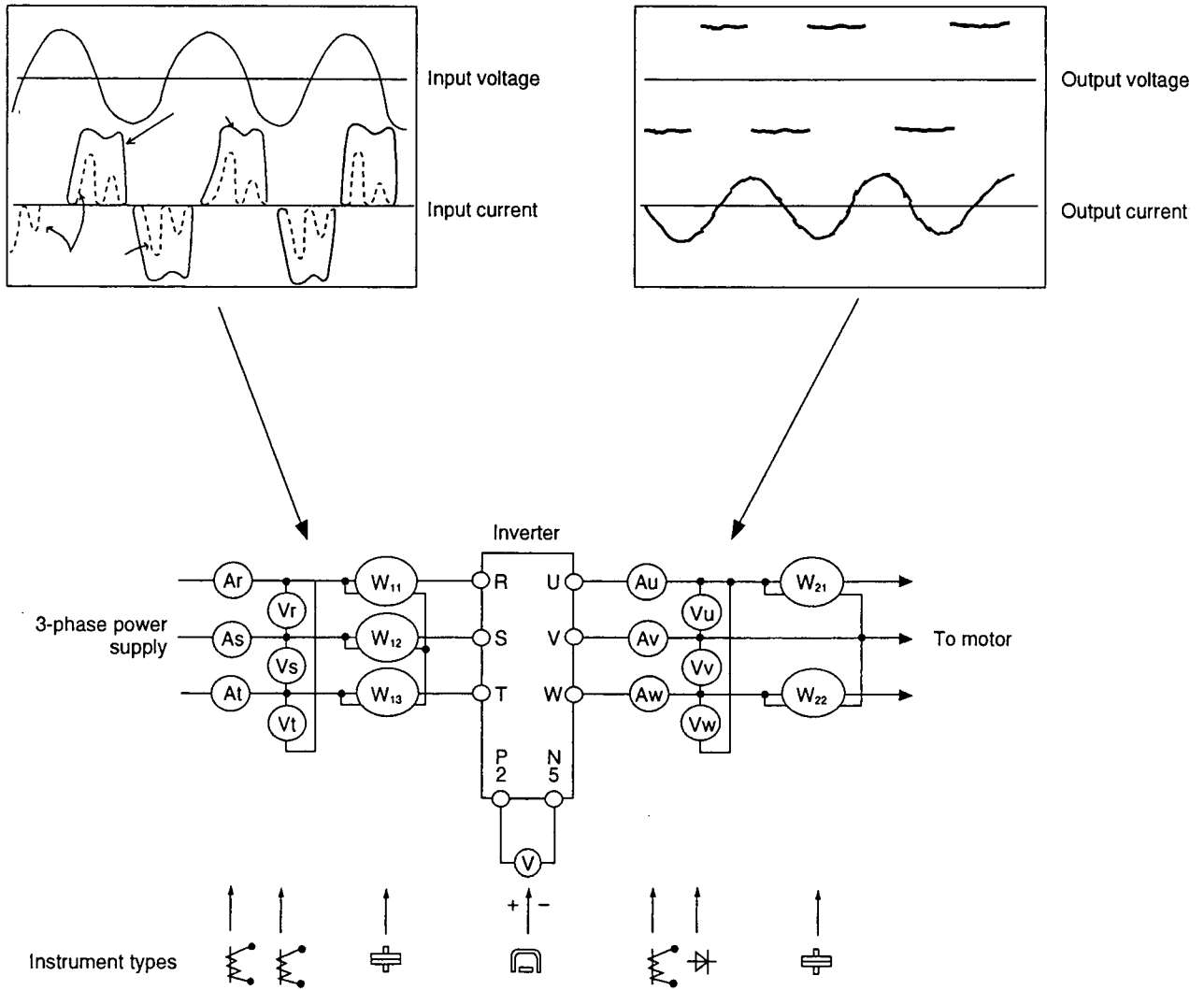

Fig. 12.2 Typical Measuring Points and Instruments

Table 2 Measuring Points and Instruments

| Item | Measuring Point | Measuring Instrument | Remarks (Reference Measured Value)* | |
|--|--|--|--|----------------|
| Power supply voltage V_1 | Across R-S, S-T and T-R | Moving-iron type | 170 to 242V (342 to 506V) 50Hz 170 to 253V (342 to 506V) 60Hz | |
| Power supply side current I_1 | R, S, and T line currents | Moving-iron type | | |
| Power supply side power P_1 | At R, S and T, and across R-S, S-T and T-R | Electrodynamic type | $P_1 = W_{11} + W_{12} + W_{13}$ | |
| Power supply side power factor Pf_1 | Calculate after measuring power supply voltage, power supply side current and power supply side power. $Pf_1 = \frac{P_1}{\sqrt{3} V_1 \cdot I_1} \times 100\%$ | | | |
| Output side voltage V_2 | Across U-V, V-W and W-U | Rectifier type (not moving-iron type) (note 1) | Difference between phases is within 1% of maximum output voltage. | |
| Output side current I_2 | U, V and W line currents | Moving-iron type | Current should be equal to or less than rated inverter current. Difference between phases is 10% or lower. | |
| Output side power P_2 | At U, V and W, and across U-V and V-W | Electrodynamic type | $P_2 = W_{21} + W_{22}$ | |
| Output side power factor Pf_2 | Calculate in similar manner to power supply side power factor. $Pf_2 = \frac{P_2}{\sqrt{3} V_2 \cdot I_2} \times 100\%$ | | | |
| Converter output | Across P-N | Moving-coil type (such as tester) | Inverter LED display is lit. $1.35 \times V_1$ Maximum 380V (760V) during regenerative operation | |
| Frequency setting signal | Across 2-5 | Moving-coil type (Tester, etc. may be used) (Internal resistance: 50k or larger) | 0 to 5V/ 0 to 10VDC | "5" is common. |
| | Across 1-5 | | 0 to \pm 5V/0 to \pm 10VDC | |
| | Across 4-5 | | 4 to 20mADC | |
| Frequency setting power supply | Across 10-5 | | 5VDC | SD is common. |
| | Across 10E-5 | | 10VDC | |
| Frequency meter signal | Across FM-SD | | Approx. 3.5VDC at maximum frequency (without frequency meter) | |
| Start signal Select signal | Across STF, STR, RH, RM, RL, JOG/OH, RT, AU-SD | | 20 to 30VDC when open ON voltage 1V or less | |
| Reset | Across RES-SD | | | |
| Output stop | Across MRS-SD | | | |
| Alarm signal | Across A-C Across B-C | Moving-coil type (such as tester) | Continuity check <Normal> <Fault> Across A-C: Discontinuity Continuity Across B-C: Continuity Discontinuity | |

* Values in brackets indicate those for 400V series.

Note 1 : Do not use a tester because an accurate data will not be obtained.

12.4 Checking the Inverter and Converter Modules

- (1) **Preparation**
- Disconnect the external power supply cables (R, S, T), motor cables (U, V, W).
 - Prepare a tester. (Use 1Ω range.)

(2) Checking

Change the polarity of the tester alternately at the inverter terminals R, S, T, U, V, W, P and N, and check for continuity.

Note 1 : Before measurement, check that the smoothing capacitor is discharged.

Note 2 : At the time of discontinuity, the measured value indicated is a nearly infinite value. Due to the influence of the smoothing capacitor, continuity may instantaneously be established and infinite not indicated. At the time of continuity, the measured value is several to several ten ohms depending on the number of modules, number of parallel modules, circuit tester type, etc. If all measured values are almost the same, the modules are without fault.

| | | Tester Polarity | | Measured Value | | | Tester Polarity | | Measured Value |
|------------------|-----|-----------------|---|----------------|-----|---|-----------------|---------------|----------------|
| | | + | - | | | | + | - | |
| Converter module | D1 | R | P | Discontinuity | D4 | R | N | Continuity | |
| | | P | R | Continuity | | N | R | Discontinuity | |
| | D2 | S | P | Discontinuity | D5 | S | N | Continuity | |
| | | P | S | Continuity | | N | S | Discontinuity | |
| | D3 | T | P | Discontinuity | D6 | T | N | Continuity | |
| | | P | T | Continuity | | N | T | Discontinuity | |
| Inverter module | TR1 | U | P | Discontinuity | TR4 | U | N | Continuity | |
| | | P | U | Continuity | | N | U | Discontinuity | |
| | TR3 | V | P | Discontinuity | TR6 | V | N | Continuity | |
| | | P | V | Continuity | | N | V | Discontinuity | |
| | TR5 | W | P | Discontinuity | TR2 | W | N | Continuity | |
| | | P | W | Continuity | | N | W | Discontinuity | |

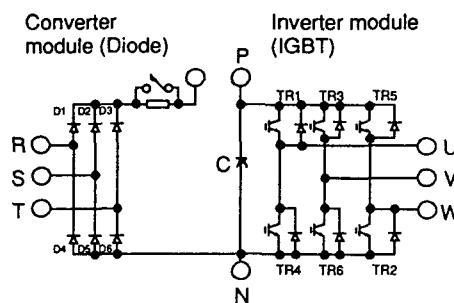

Fig. 12.3 Module Device Numbers and Terminals to Be Checked

12.5 Replacement of Parts

The inverter consists of many electronic parts such as semiconductor devices. The following parts may deteriorate with age because of their structures or physical characteristics, leading to reduced performance or failure of the inverter. For preventive maintenance, the parts must be changed periodically.

(1) Cooling fan

The cooling fan cools heat-generating parts such as the main circuit semiconductor devices. The life of the cooling fan bearing is usually 10,000 to 35,000 hours. Hence, the cooling fan must be changed every 2 to 3 years if the inverter is run continuously. When unusual noise and/or vibration is noticed during inspection, the cooling fan must be changed immediately.

(2) Smoothing capacitor

A large-capacity aluminum electrolytic capacitor is used for smoothing the DC in the main circuit, and an aluminum electrolytic capacitor is also used for stabilizing the control power supply in the control circuit. Its characteristics are adversely affected by ripple current, etc. When the inverter is operated in ordinary, air-conditioned environment, change the capacitor about every 5 years. When 5 years have elapsed, the capacitor deteriorates more rapidly. Check the capacitor at least every year (less than six months if the life will be expired soon). Check the following:

- 1) Case (side faces and bottom face for expansion)
- 2) Sealing plate (for remarkable warp and extreme crack)
- 3) Explosion-proof valve (for excessive valve expansion and operation)
- 4) Appearance, external crack, discoloration, leakage.

When the measured capacitance of the capacitor has reduced below 85% of the rating, change the capacitor. For capacitance measurement, a handy device is available on the market.

(3) Relays

To prevent contact fault, relays must be changed according to the number of accumulative switching times (switching life). See Table 4 for the inverter parts replacement guide. Lamps and other short-life parts must also be changed during periodic inspection.

Table 4 Replacement Parts of the Inverter

| Part Name | Standard Replacement Interval | Description |
|--------------------------------------|-------------------------------|----------------------|
| Cooling fan | 2 to 3 years | Change (as required) |
| Smoothing capacitor in main circuit | 5 years | Change (as required) |
| Smoothing capacitor on circuit board | 5 years | Same as above |
| Relays | ————— | Change as required. |

13. TROUBLESHOOTING

If any function of the inverter is lost due to occurrence of a fault, establish the cause and make correction in accordance with the following inspection procedure. Contact your sales representative if the corresponding fault is not found below, the inverter has failed, the part has been damaged, or any other fault has occurred.

13.1 Clearing Up the Cause of Fault

Checking the parameter unit display

The display of the parameter unit is switched as follows to indicate the cause of a faulty operation.

| Parameter Unit | Cause of Fault | Check Point | Remedy |
|--|--|--|--|
| OC During Acc | Main circuit device overheat | Acceleration too fast? Check for output short circuit or ground fault. Check for cooling fan stop. | Increase acceleration time. Change fan. Remove obstacle to cooling fan. (Note) |
| Stedy Spd Oc | | Sudden load change? Check for output short circuit or ground fault. Check for cooling fan stop. | Keep load stable. Change fan. Remove obstacle to cooling fan. (Note) |
| OC During Dec | | Deceleration too fast? Check for output short circuit or ground fault. Check for cooling fan stop. | Increase deceleration time. Change fan. Remove obstacle to cooling fan. (Note) |
| Ov During Acc | Overvoltage on DC bus (terminals P-N) | Acceleration too fast? | Increase acceleration time. |
| Stedy Spd Ov | | Sudden load change? | Keep load stable. |
| Ov During Dec | | Deceleration too fast? | Increase deceleration time. (Set deceleration time which matches load GD ² .) |
| Motor Overload | Thermal relay for motor | Motor used under overload? | Reduce load. Increase motor and inverter capacities. |
| Inv. Overload | Thermal relay for inverter | | |
| Inst. Pwr. Loss | Instantaneous power failure | Check the cause of instantaneous power failure occurrence. | |
| Under Voltage | Drop of power supply voltage | Large-capacity motor started? | Check power system equipment such as power supply capacity. |
| Br. Cct. Fault | Brake transistor fault | Braking duty correct? | Reduce load GD ² . Reduce braking duty. |
| Ground Fault | Ground fault occurred in output circuit. | Check motor and cables for ground fault. | Remedy ground fault area. |
| OH Fault | External thermal relay operated. | Check motor for overheat. | Reduce load and frequency of operation. |
| Still Prev STP | Stall prevention or current limit function activated too long. | Motor used under overload? | Reduce load. Increase motor and inverter capacities. |
| Option Fault | Option and inverter connected improperly. | Check for loose connector. | Securely connect. |
| Corrupt Memry | Storage device (EEPROM) capacity exceeded, faulty | Number of parameter write times too many? | Change inverter. |
| Retry No. Over | Operation could not be resumed within the number of retry times set. | Check cause of alarm occurrence. | |
| CPU Fault | CPU malfunction | | Change inverter. |
| PU Leave Out | The PU has been disconnected from the connector. | Check that the PU is connected securely. | Securely install the PU. |
| PU to Inverter comms. Error Inv. Reset ON | <ul style="list-style-type: none"> • Reset signal ON • Loose connection between PU and inverter • Communication circuit fault | <ul style="list-style-type: none"> • Check for miswiring to reset terminal • Check for loose connector | <ul style="list-style-type: none"> • Turn the reset signal off • Securely connect • Change inverter |

Note: This alarm does not occur due to the cooling fan stop, but it will occur to prevent the power devices from overheating by the fan failure.

13. 2 Faults and Check Points

| Fault | Typical Check Point |
|--|---|
| Motor does not rotate. | (1) Checking the main circuit <ul style="list-style-type: none"> • Check that the power is applied (inverter LED display is lit). • Check that the motor is connected properly. (2) Checking the input signals <ul style="list-style-type: none"> • Check that the start signal is present. • Check that both the forward and reverse start signals are not present simultaneously. • Check that the frequency setting signal is not at zero. • Check that the signal across terminals AU and SD is on when the frequency setting signal is 4 to 20mA. • Check that the output stop signal (across terminals MRS-SD) or reset signal (across RES-SD) is not on. (3) Checking the function (parameter) set values <ul style="list-style-type: none"> • Check that the reverse rotation prevention (Pr. 78) is not set. • Check that the operation mode (Pr. 79) setting is correct. • Check that the bias and gain (Pr. 902 to Pr. 905) settings are correct. • Check that the starting frequency (Pr. 13) set value is not greater than the running frequency. • Check that various operational functions (such as three-speed operation), especially the maximum frequency, are not zero. (4) Checking the load <ul style="list-style-type: none"> • Check that the load is not too heavy and the shaft is not locked. (5) Others <ul style="list-style-type: none"> • Check that the inverter LED display (ALARM) is not lit. |
| The motor rotates in opposite direction. | <ul style="list-style-type: none"> • Check that the phase sequence of the output terminals U, V and W is correct. • Check that the start signals (forward, reverse) are connected properly. |
| Speed greatly differs from the pre-determined value. | <ul style="list-style-type: none"> • Check that the frequency setting signal is proper. (Measure the input signal level.) • Check that the following function (parameter) set values are proper: Maximum frequency (Pr. 1), acceleration/deceleration reference frequency (Pr. 20), acceleration/deceleration time increment (Pr. 21), bias, gain (Pr. 902 to Pr. 905), base frequency voltage (Pr. 19) • Check that the input signal lines are not affected by external noise. (Use of shielded cables) |
| Acceleration/deceleration is not smooth. | <ul style="list-style-type: none"> • Check that the acceleration/deceleration time set value is not too short. • Check that the load is not too heavy. • Check that the torque boost set value is not too large to activate the current limit function. |
| Speed varies during operation. | <ul style="list-style-type: none"> • Check that the load is not varying. • Check that the frequency setting signal is not varying. • Check that the settings of the applied motor capacity (Pr. 80) and number of applied motor poles (Pr. 81) are correct for the inverter capacity and motor capacity in magnetic flux vector control. • Check that the wiring length is within 30m in magnetic flux vector control. • Check that the wiring length is proper in V/F control. <p>Remedy: Change the setting of special parameter 97 (Td compensation) to 0. This parameter is displayed only when 801 is set in Pr. 77.</p> <p>Note: Parameters Pr. 82 to 99, which are also displayed simultaneously when 801 is set in Pr. 77, must not be set to protect the inverter from damage.</p> |
| Motor current is large. | <ul style="list-style-type: none"> • Check that the load is not too heavy. • Check that the torque boost (manual) set value is not too large. |
| Speed does not increase. | <ul style="list-style-type: none"> • Check that the maximum frequency set value is proper, i.e. it is not too small. • Check that the load is not too heavy. • Check that the torque boost set value is not too large to activate the current limit function. |
| "PU to inverter comms. error" is displayed on the PU screen. | <ul style="list-style-type: none"> • Check that the reset signal (terminals RES-SD) is not ON. • Check that the PU is connected securely. |

Note: Pr. indicates a function number (parameter).

13.3 Protective Functions

When any of the protective functions has been activated, switch the power off, then on, or reset the inverter with the reset terminal (RES). (Inverter reset can also be executed in the PU help menu.)

| Function | Description | Display | | Alarm Code | Alarm Output | |
|--|---|--------------------------------------|---|--------------|---|----------|
| | | Parameter unit | Inverter LED | | | |
| Acceleration/constant-speed stall prevention Current limit | If a current not less than 120%* of the rated inverter current flows in the motor during acceleration, this function stops the increase in frequency until the load current reduces to prevent the inverter from resulting in overcurrent trip. If a current not less than 120% of the rated current flows during steady (constant-speed) operation, this function also lowers the frequency until the load current reduces to prevent the inverter from resulting in overcurrent trip. When the load current has reduced below 120%, this function increases the frequency again and accelerates up to the set speed or continues operation. | OL is shown (during motor rotation). | EOL_F (EOLT) Indicates a stop due to the activation of the function for a long time during constant-speed operation. | D | Not provided. Provided by EDLT display. | |
| Deceleration stall prevention | If the brake operating amount has exceeded the specified value due to excessive regenerative energy during motor deceleration, this function stops the decrease in frequency to prevent the inverter from resulting in overvoltage trip. As soon as the regenerative energy has reduced, this function reduces the frequency again and continues deceleration. | Stll Prew STP (at a motor stop) | | | | |
| Overcurrent shut-off | When the inverter output current has reached or exceeded 135% of the rated current, the protective circuit is activated to stop the inverter. | During acceleration | OC During Acc | EOL 1 | 1 | Provided |
| | | During constant-speed operation | Stedy Spd Oc | EOL 2 | 2 | |
| | | During deceleration | Oc During Dec | EOL 3 | 3 | |
| Regenerative overvoltage shut-off | When a. d. c. bus overvoltage is caused by regenerative energy from the motor or power line single voltage, the protective circuit is activated to stop the transistor output and keep it stopped. | During acceleration | Ov During Acc | EOV 1 | 4 | Provided |
| | | During constant-speed operation | Stedy Spd Ov | EOV 2 | | |
| | | During deceleration | Ov During Dec | EOV 3 | | |
| Instantaneous power failure protection | If instantaneous power failure has occurred in excess of 15 msec (this applies also to inverter input power shut-off), this function is activated to stop the inverter output and keep it stopped. At this time, the alarm output contacts are open (across B-C). (If the power failure is within 15msec, the control circuit operates without fault. If the power failure continues for more than about 100msec, the protective circuit is reset.) | Inst. Pwr. Loss | EIPF (EIPF) | 7 | Provided | |
| Undervoltage protection | If the inverter power supply voltage has reduced, the control circuit cannot operate properly, resulting in the decrease in motor torque and/or the increase in heat generation. To prevent this, if the power supply voltage reduces below about 300V, this function stops the inverter output. | Under Voltage | EUUV (EUVT) | 8 | Provided | |
| Brake transistor fault detection | If the brake transistor fault has occurred due to extremely large regenerative brake duty, etc., this function detects that fault and stops the inverter output. | Br. Cct. Fault | EBE (EBE) | A | Provided | |
| Overload shut-off (electronic thermal O/L) | The electronic overcurrent protection in the inverter detects motor overload during rated operation or motor overheat during low-speed operation, activates the protective circuit, and stops the inverter output and keeps it stopped. When, for example, a multi-pole motor or more than one motor is driven, the motor(s) cannot be protected by the electronic overcurrent protection. Provide a thermal relay in the inverter output circuit. In this case, setting the electronic overcurrent protection value to 0A activates the inverter protection only. (Activated at a current 120% or more of the rated current.) | Motor Overload | Motor protection ETHM (ETHM) | 5 | Provided | |
| | | Inv. Overload | Inverter protection ETHI (ETHI) | 6 | Provided | |

Note:

*Indicates factory-set value when current level for stall prevention operation is set at 120%. When changed, stall prevention function operates at the new set value.

| Function | Description | Display | | Alarm Code | Alarm Output |
|---|---|--|-------------------------|------------|--------------|
| | | Parameter unit | Inverter LED | | |
| Load side ground fault overcurrent protection | If a ground fault current has flown due to a ground fault occurring in the output (load) side of the inverter, this function stops the inverter output. A ground fault occurring at low ground resistance may activate the overcurrent protection (OC 1 to OC3.) | Ground Fault | E GE (EGF) | B | Provided |
| External thermal O/L operation ** | If the external thermal relay for motor overheat protection or the internally mounted temperature relay in the motor has been switched on (relay contacts open), this function stops the inverter output and keeps it stopped. This protection is only provided when the external thermal relay input function has been selected. | OH Fault | E OHT (EOHT) | C | Provided |
| Built-in option error | Stops the inverter output if the dedicated option used in the inverter results in connection (connector) fault during operation. | Option Fault | E OPT (EOPT) | E | Provided |
| Parameter Error | Stops the output if the specified number of write times (100,000 times) to EEPROM, which stores the function set values, has been exceeded or a device fault has occurred. | Corrupt Memory | E PE (EPE) | F | Provided |
| Retry count over | If operation cannot be resumed within the number of retry times set, this function stops the inverter output. | Retry No. Over | E r ET (ERET) | F | Provided |
| CPU error | If the operation of the built-in CPU does not end within a predetermined period of time, the inverter self-determines it as alarm and stops the output. | CPU Fault | E CPU (ECPU) | F | Provided |
| Parameter unit disconnection error | Stops the inverter output if the parameter unit is disconnected. This protective function is activated only when the PU disconnection detection function has been selected. | PU Leave Out | E PUE (EPUE) | F | Provided |
| DC fuse Blown | Indicates that the DC fuse has blown. This function stops the inverter output. | Either OC1, OC2, and OC3 will be displayed depending on whether "under acceleration", "under constant speed", or "under deceleration." | E FUE (ECPU) | 9 | Provided |
| P-N transistor short-circuited | Indicates that the arm across P and N internal the transistor is short-circuited. This function stops the inverter output. | | E r FT (EPUE) | 9 | Provided |
| Heat sink overheat protection | If the cooling fins overheat because the cooling fan has stopped due to some problem or because the fins are clogged, the inverter output will be stopped to protect the transistor. | Fin overheat | E FOT (FOT) | 9 | Provided |
| Cooling fan stop | Indicates that the cooling fan has stopped due to an abnormality. This function stops the inverter output. | Fan stop | E FAn (FAN) | 9 | Provided |
| Over frequency shut-off | Stops the inverter output if the output frequency exceeds the set value by 105% or higher due to a CPU abnormality. | CPU error | E OFT (OFT) | 9 | Provided |

Note:
**External thermal O/L: operation is active only when external thermal O/L input select function is set.

13.4 Alarm Code Output

With Pr. 76 (alarm code output selection), fault contents can be output as a four-bit digital signal. This signal is output from the inverter using the open collector output terminals provided as standard. Fault contents and corresponding alarm code are shown in the table below.

| Alarm Definition (Protective Function) | | Inverter LED Display | Output Terminal Signal On/Off* | | | | (Alarm Code) |
|---|---------------------------------|-------------------------|--------------------------------|-----|----|----|--------------|
| | | | SU | IPF | OL | FU | |
| Normal operation | | — | 0 | 0 | 0 | 0 | 0 |
| Overcurrent shut-off | During acceleration | E. OC1 | 0 | 0 | 0 | 1 | 1 |
| | During constant-speed operation | E. OC2 | 0 | 0 | 1 | 0 | 2 |
| | During deceleration | E. OC3 | 0 | 0 | 1 | 1 | 3 |
| Regenerative overvoltage shut-off | | E. OV1 to 3 | 0 | 1 | 0 | 0 | 4 |
| Electronic thermal O/L | Motor protection | E. THM | 0 | 1 | 0 | 1 | 5 |
| | Inverter protection | E. THT | 0 | 1 | 1 | 0 | 6 |
| Instantaneous power failure | | E. IPF | 0 | 1 | 1 | 1 | 7 |
| Undervoltage | | E. UVT | 1 | 0 | 0 | 0 | 8 |
| Brake transistor fault | | E. BE | 1 | 0 | 1 | 0 | A |
| Load-side ground fault/overcurrent | | E. GF | 1 | 0 | 1 | 1 | B |
| External thermal O/L operation | | E. OHT | 1 | 1 | 0 | 0 | C |
| Stop due to stall operation | | E. OLT | 1 | 1 | 0 | 1 | D |
| Built-in option error | | E. OPT | 1 | 1 | 1 | 0 | E |
| Parameter memory fault | | E. PE | 1 | 1 | 1 | 1 | F |
| Retry count over | | E. RET | | | | | |
| CPU error | | E. CPU | | | | | |
| Parameter unit disconnection | | E. PUE | | | | | |
| DC Fuse Blown | | E. FUT | 1 | 0 | 0 | 1 | 9 |
| P-N Transistor short-circuited | | E. ATT/E. OC1~3 | 1 | 0 | 0 | 1 | 9 |
| Heat sink overheating | | E. FINE/E. OC1~3 | 1 | 0 | 0 | 1 | 9 |
| Cooling fan stop | | E. FAN | 1 | 0 | 0 | 1 | 9 |
| Over frequency shutoff | | E. OFT | 1 | 1 | 1 | 1 | F |

*0: output transistor off, 1: output transistor on (common terminal: SE)

14. SPECIFICATIONS

14.1 MELTRAC-A140E Standard Specification

| Model | | MT- <input type="text"/> - <input type="text"/> | MT-A140E-75K | MT-A140E-110K | MT-A140E-150K | MT-A140E-220K | MT-A140E-280K | MT-A140E-375K | |
|--------------------------------------|---|---|---|---------------------|---------------|---------------|---------------|---------------|--|
| Output rating | Rated capacity (kVA) *1 | Variable Torque | 110 | 165 | 220 | 330 | 420 | 550 | |
| | | Constant Torque | 80 | 110 | 165 | 220 | 330 | 420 | |
| | Rated current | Variable Torque | 144 | 216 | 288 | 432 | 547 | 722 | |
| | | Constant Torque | 106 | 144 | 216 | 325 | 432 | 547 | |
| | Voltage | | 3-phase, 380V to 460V (max.), 50/60Hz | | | | | | |
| | Applicable Motor *2 kW (HP at 460V) | Variable Torque | 75 (100) | 110 (150) | 150 (200) | 220 (300) | 280 (400) | 375 (500) | |
| | | Constant Torque | 55 (75) | 75 (100) | 110 (150) | 160 (210) | 220 (300) | 280 (400) | |
| Overload current rating | | *3 | 120%, 60 seconds | | | | | | |
| Output voltage | | *4 | 3-phase, 380V to 460V 50/60Hz | | | | | | |
| Input rating | Voltage/frequency | | 3-phase, 380V to 460V 50/60Hz | | | | | | |
| | Allowable voltage fluctuation | | *5 | 323 to 506V 50/60Hz | | | | | |
| | Allowable frequency fluctuation | | ±5% | | | | | | |
| | Power supply capacity | | Same as output capacity | | | | | | |
| Control specifications | Control system | | PWM control (V/F control or Primary Magnetic Flux Control can be selected) | | | | | | |
| | Frequency control range | | 0.5 to 400Hz | | | | | | |
| | Frequency setting resolution | Analog input | 0.06Hz/60Hz (Input terminal No. 2: 10bit/0 to 10V, 9bit/0 to 5V, Input terminal No. 1: 10bit/-10 to +10V, 9bit/-5V to +5V) | | | | | | |
| | | Digital input | 0.015Hz/60Hz (when optional T-OPT20 is mounted) 0.01Hz/60Hz (when parameter unit is used) | | | | | | |
| | Frequency accuracy | | Within ±0.2% of the maximum output frequency (at 25°C ±10°C)/at analog input Within 0.02% of the set output frequency/at digital input | | | | | | |
| | Voltage/frequency characteristic | | Base frequency can be set between 0 to 400Hz. Constant torque or Variable torque pattern can be selected. | | | | | | |
| | Torque boost | | Manual and automatic torque boost | | | | | | |
| | Acceleration/deceleration time setting | | 0 to 3600 sec. (acceleration and deceleration can be set individually) Linear or S-shaped acceleration/deceleration mode can be selected. | | | | | | |
| | DC braking | | Operating frequency (0 to 120Hz), time (0 to 10 sec.), and voltage (0 to 30%) are adjustable. | | | | | | |
| | Stall prevention operation level | | Operating current can be set (0 to 120%), presence or absence can be selected. | | | | | | |
| | Current limit control | | Current limit can be set (0 to 120%) presence or absence can be selected. | | | | | | |
| Protection structure, cooling system | | Open type (IP00), forced air cooling | | | | | | | |
| Approximate weight kg (lb.) | | 40 (88) | 66 (146) | 67 (148) | 115 (254) | 155 (342) | 235 (519) | | |
| Operation specifications | Frequency setting signal | Analog | DC0 to 5V, 0 to 10V, 0 to ±5V, 0 to ±10V, 4 to 20mA | | | | | | |
| | | Digital | Use of parameter units. 4-Digit+BCD or 16-bit binary (when the optional T-OPT20 is used) | | | | | | |
| | Input signal | Start signal | 3-wire input for forward and reverse rotation can be selected. | | | | | | |
| | | Multi-speed selection | Up to 7 speeds can be selected (each speed can be set between 0 to 400Hz, Run speed can be changed during operation from the parameter unit). | | | | | | |
| | | Alternate acceleration/deceleration time select | 0 to 3600 seconds (acceleration and deceleration can be set individually.) | | | | | | |
| | | Jogging operation select | A (JOG) mode select terminal is provided. *6 | | | | | | |
| | | Current input selection | Input of 4 to 20mA DC frequency setting signal (terminal No. 4) is selected. | | | | | | |
| | | Output stop | Instantaneous shut-off of inverter output (frequency and voltage) | | | | | | |
| Alarm reset | Alarm retained at the activation of protective function is reset. | | | | | | | | |

| | | | |
|-----------------------|---|---|--|
| Output rating | Operation functions | | Maximum/minimum frequency settings, frequency jump operation, external thermal O/L relay input selection, Polarity reverse operation, auto-restart after instantaneous power failure, commercial power - inverter switch-over operation, forward/reverse rotation prevention, slip compensation, operation mode selection and unmode are selected. |
| | Output signals | Operating status | Up to four can be selected among: inverter running, up to frequency, instantaneous power failure (undervoltage), frequency detection, second frequency detection, program mode operation, during PU operation, overload alarm, regeneration brake pre-alarm, and electronic thermal O/L pre-alarm. Open collector output |
| | | Alarm (inverter trip) | Contact output ... 1C contact (230VAC, 0.3A, 30VDC, 0.3A) Open collector ... Alarm code output (4 bits) |
| | | For indicating meter | Select one from: output frequency, motor current (steady or peak value), output voltage, frequency set value, running speed, motor torque, converter output voltage (steady or peak value), regenerative brake usage rate, electronic thermal O/L load factor, input power, output power, load meter, motor excitation current. Pulse train output (1440Hz/full scale) or analog output (0-10VDC). |
| Display | On parameter unit or inverter LED | Operating status | Select from: output frequency, motor current (steady or peak value), output voltage, frequency set value, running speed, motor torque, overload, converter output voltage (steady or peak value), electronic thermal O/L load factor, input power, output power, load meter, motor excitation current, integration operating time, and regenerative brake use rate. |
| | | Alarm definition | Alarm definition is displayed when protective function is activated. 8 alarm definitions are stored. |
| | Additional display to parameter unit only | Operating status | Presence or absence of input terminal signals, and output terminal signals |
| | | Alarm definition | Output voltage, current, frequency, I/O terminal state immediately before protective function is activated |
| | | Interactive guidance | Operation guide, troubleshooting, graphic display and HELP function |
| | Protective/alarm functions | | Overcurrent shutoff (during acceleration, deceleration, and constant speed), regenerative overvoltage shutoff, undervoltage, instantaneous power failure, overload shutoff (electronic thermal O/L), heat sink temp., ground-fault overcurrent, output short circuit, stall prevention, overload alarm, brake transistor protection (with MT-BU), fuse off, overfrequency, and cooling fan stopped |
| Standard accessory *7 | | DC reactor to improve power factor (installed separately) | |
| Environment | Ambient temperature | | -10°C to +50°C (14 to 122°F), -10°C to +40°C (14 to 104°F) when the totally enclosed structure is used. |
| | Ambient humidity | | 90% RH or less (Noncondensing) |
| | Storage temperature *8 | | -20°C to +65°C (-4 to 149°F) |
| | Ambience | | For indoor use; no corrosive gases, inflammable gas, oil mist, dust or dirt present. |
| | Altitude, vibration | | Below 1000m, 5.9m/S ² {0.6G} or less |

Notes: *1. Indicated for rated capacity of 440V.

*2. Indicates maximum capacity when four-pole standard squirrel cage motor is used.

*3. % value indicates ratio of inverter rated output current. For repeated use, allow inverter and motor temperature value to cool to less than that at 100% load.

*4. Maximum output voltage can be set to any value below input supply voltage.

*5. 400V series inverter: If the supply voltage changes by +10% or -15% or 380 - 440V, 50/60Hz, keep the short-bar attached between terminals X and XI on the control card (T-CNT20). If the change is +10% or -15% of 440 - 460V, 50/60Hz, remove that short-bar. Refer to the instruction manual for details.

*6. Jog operation can also be performed using parameter unit.

*7. This reactor is supplied together with the inverter. Attach the reactor whenever the inverter is operated.

*8. Indicates temperatures that can be applied for short periods during transportation, etc.

14.2 Applicable motor capacity for Inverter power rating

Software to control either the variable torque applications or constant torque applications has been incorporated into MELTRAC-A series inverter.

The user is able to select either the normal variable torque rating with 120% overload capability or a next smaller motor rating for use on constant torque applications which unit has 150% overload capability.

| Applicable motor capacity (kW) | Supply voltage 380 to 460V class | |
|--------------------------------|---|----------------|
| | Rated output current (A) Variable Torque/ Constant Torque | Inverter Model |
| 75kW (100HP)/55kW (75HP) | 144A/106A | MT-A140E-75K |
| 110kW (150HP)/75kW (100HP) | 216A/144A | MT-A140E-110K |
| 150kW (200HP)/110kW (150HP) | 288A/216A | MT-A140E-150K |
| 220kW (300HP)/160kW (210HP) | 432A/325A | MT-A140E-220K |
| 280kW (400HP)/220kW (300HP) | 547A/432A | MT-A140E-280K |
| 375kW (500HP)/280kW (400HP) | 722A/547A | MT-A140E-375K |

Note 1: When selecting an applicable motor, make sure that motor full load current multiplied by 1.1 must NOT exceed inverter rated output current.

Note 2: Motor horse power rating is only at 460V.

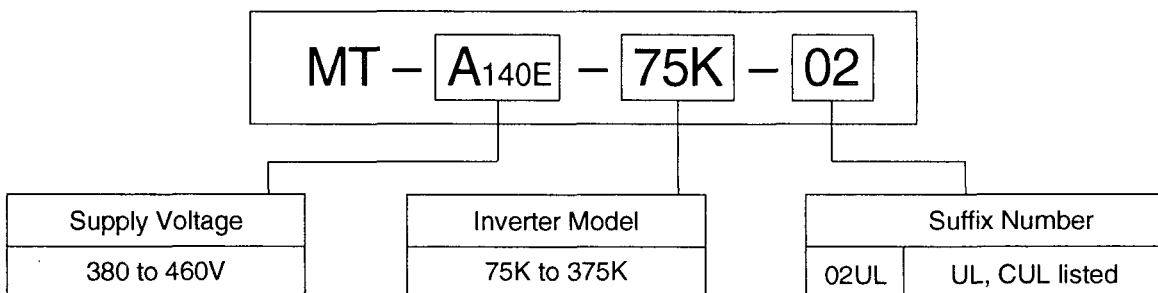

15. Standard connection diagram and terminal specifications

15.1 Internal block diagram

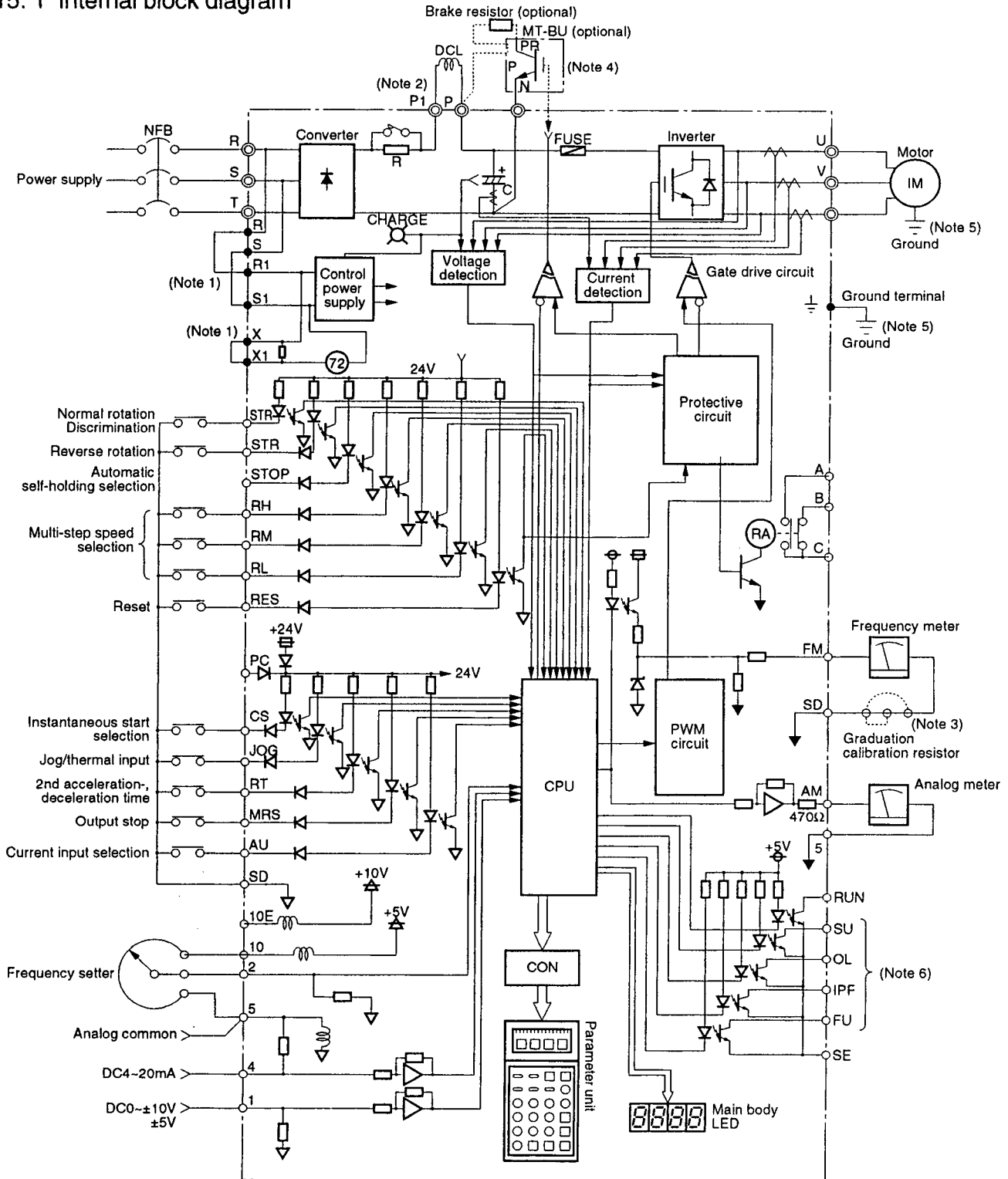

- Note: 1. If the control power is supplied from another power source, remove the short-circuit pieces from R-R1 and S-S1, and input the same power as the main circuit. If the power of the main circuit is 440 to 460V, remove the short-circuit piece from X - X1.
2. Connect the power factor improving DC reactor across the terminals P and P1.
3. The parameter unit is unnecessary for scale calibration.
4. If torque control is necessary, connect the optional brake unit (MT-BU) and brake resistor across P and N.
5. Be sure to ground the inverter and the motor.
6. It is possible to output the abnormality content as an alarm code and individually allocate ten kinds of function.

15. 2 Specifications of input/output terminals

| Terminal code | Terminal name | Rating and others | Application | Reference page | |
|--------------------------------|---|---|---|--|---|
| Main circuit and power circuit | R, S, T | AC power input terminal | 3-phase 200~230V 50/60Hz 3-phase 380~460V 50/60Hz | Install the power coordinative AC reactor if the inverter uses an especially large capacity power supply of specially, the voltage phase imbalance is 3% or more and a thyristor converter is provided in the same system. | P10-11 |
| | U, V, W | Inverter output terminal | — | Connect the 3-phase induction motor. The output voltage should not exceed the input voltage. | P10-11 |
| | P N | Converter output terminal | — | The terminal is used a regenerative motor brake by connecting the optional power regenerative converter (MT-RC) and Model regenerative unit. Never attempt to connect anything other than the power regenerative converter (MT-RC) and brake unit (MT-BU). If P and P1 are short-circuited, the inverter will be damaged. | — |
| | P, P1 | Power factor improving DC reactor connection terminal | — | Connector the power factor improving DC reactor which is provided as an accessory. | — |
| | R1, S1 | Control circuit power terminal | AC power terminals R, S and T and the same rated power consumption 50 VA (provided on the printed-circuit board) | The power terminals R and S are connected by the short-circuit bridge. Even if the inverter power is turned off, the fault display and fault output signal will be maintained since the power is supplied from the other system. In this case, be sure to remove the short-circuit bridge. | P12 |
| |  | Ground terminal | — | Be sure to ground the circuit. | — |
| | Control circuit (input signal) | STF | Normal rotation start input signal terminal | Input resistor 4.7 kΩ Opened voltage DC 21 to 27 V Shorted current DC 4~6 mA Photo-coupler insulation | Normal rotation is commanded by a short circuit across STF and SD, and stop is commanded by a open circuit. In case of the program operation mode, the program operation start signal is commanded across STF and SD. If the circuits are simultaneously shorted across STF and SD and across STR and SC, stop is commanded. In case of operation, it is decelerated and stopped. |
| STR | | Reverse rotation start input signal terminal | Controllable with open collector output or non-voltage contact point signal | | |
| STOP | | Start self-holding selective terminal | Input resistor 4.7 kΩ Opened voltage DC 21 to 27 V Shorted current DC 4~6 mA Photo-coupler insulation Controllable with open collector output or non-voltage contact point signal | If the circuit across STOP and SD is shorted, the self- holding start system is selected. After the circuit across the start signal terminals STF and STR-SD has been shorted once, the start signal will be maintained to continuously operate the inverter even if it is opened. In order to stop the motor or change the rotation direction, open and close the circuit across the terminals STOP and SD, and close and open the circuit across the start signal terminals STR (STF) and SD. The self-holding start system prevents the inverter from automatically restarting when power failure has been rectified. | P13 |

| Terminal code | Terminal name | Rating and others | Application | Reference page | |
|--------------------------------|-------------------------------|--|---|---|-----|
| Control circuit (input signal) | RH, RM, RL | 3-speed selective terminal | Input resistor 4.7 k Ω Opened voltage 21 to 27 V DC Shorted current 4~6 mA DC Photo-coupler insulation | When the circuit across RH and SD is shorted, operation is possible at the set frequency 4 (0 to 400 Hz) with the parameter unit. Operation is possible at the set frequency 5 (0 to 400 Hz) for a short circuit across RM and SD and at the set frequency 6 (0 to 400 Hz) for a short circuit across RL and SD. If any plural circuits across RH, RM and RL to SD are simultaneously shorted, the low-speed side terminal has the priority. | P49 |
| | | Multi-step speed selective terminal | Controllable with open collector output or non-voltage contact point signal | In case of multi-speed selection, a maximum of 7 speeds can be selected with the combination of short-circuits across RH, RM and RL to SD when the multi-step speed frequencies (0 to 400 Hz) are at 24 thru 27 with the parameter unit. | |
| | JOG/OH | JOG mode selection and external thermal input terminal | Input resistor 4.7 k Ω Opened voltage 21 to 27 V DC Shorted current 4~6 mA DC Photo-coupler insulation Controllable with open collector output or non-voltage contact point signal | When the JOG mode is selected, select 17 (setting value 0) with the parameter unit, short the circuit across JOG and SD, and use the circuits across the start signal terminals STF (STR) and S in order to start and stop the operation. Moreover, when the external thermal input terminal is selected, select 17 (setting value 1) and connect the contact point of the thermal relay across JOG/OH and SD. If the thermal relay is activated, the inverter is stopped and held and the abnormality is output. Even if the contact point of the thermal relay is automatically reset, the inverter is not restarted. To reset, short the circuit across RES and SD, and reset the power. | P51 |
| | RT | 2nd acceleration-, deceleration time selective terminal | Input resistor 4.7 k Ω Opened voltage 21 to 27 V DC Shorted current 4~6 mA DC Photo-coupler insulation Controllable with open collector output or non-voltage contact point signal | When the circuit across RT and SD is shorted, the 2nd acceleration-, deceleration time 44 or 45 (0 to 3,600 seconds) and the 2nd torque boost 46 and 2nd V/F 47 are selected. Set the acceleration-, deceleration time with the parameter unit. When the circuit across RT and SD is opened, it is operated with 7 and 8 acceleration-, deceleration time (0 to 3,600 seconds) and the torque boost 0 and V/F 3. | P54 |
| MRS | Inverter output stop terminal | Input resistor 4.7 k Ω Opened voltage 21 to 27 V DC Shorted current 4~6 mA DC Photo-coupler insulation Controllable with open collector output or non-voltage contact point signal | The inverter output is shut down to stop the motor in the free run mode. It is used to shut down output of the inverter in order to stop the motor with the mechanical type brake or similar. Make the interval between the terminals MRS-SD short-circuited for 20 msec or longer. | — | |

| Terminal code | Terminal name | Rating and others | Application | Reference page | |
|--------------------------------|---------------|--|---|---|-----|
| Control circuit (input signal) | RES | Reset terminal | Input resistor 4.7 k Ω Opened voltage 21 to 27 V DC Shorted current 4~6 mA DC Photo-coupler insulation Controllable with open collector output or non-voltage contact point signal | This is provided to reset and cancel a stop condition of the inverter resulting from activation of the protective circuit in case of an abnormality. Each section of the control circuit is immediately brought into the initial state, and the output of the inverter is simultaneously shut down. Open the reset input after the circuit across the terminals REC and SD is shorted for 0.1 second or more. Though the initial reset is automatically executed in the inverter when power is supplied, 0.1 to 0.2 seconds are required after power is supplied. During resetting, the inverter does not output. | — |
| | AU | Current input selective terminal | Input resistor 4.7 k Ω Opened voltage 21 to 27 V DC Shorted current 4~6 mA DC Photo-coupler insulation Controllable with open collector output or non-voltage contact point signal | When the circuit across AU and SD only is shorted, operation is possible with the 4~20 mA DC frequency setting signal which is input across terminals 4 and 5. When the circuit across AU and SD is open, the input signal across terminals 4 and 5 is invalid. If the multi-step speed terminal is input the multi-step speed has the priority. | — |
| | PC | External transistor common positive terminal | Power voltage range 22 to 26 V DC Current consumption 100 mA | The common terminal on the positive side of the external power is connected to prevent a malfunction resulting from the back-flow current when the output (open collector) of the sequencer (PC) or the transistor which has the external power supply is input to the inverter. | — |
| | CS | Instantaneous restart selective terminal | Input resistor 4.7 k Ω Opened voltage 21 to 27 V DC Shorted current 4~6 mA DC Photo-coupler insulation Controllable with open collector output or non-voltage contact point signal | When the circuit across CS and SD is shorted, the automatic restart control is possible with the instantaneous power failure and recovery (recovery time is not limited). If it is undesirable that operation is automatically restarted after the instantaneous power failure and recovery, open the circuit across the terminals CS and SD. | P56 |
| | SD | Contact point input common terminal | — | Common terminal for contact point input signal and frequency meter. Insulated from the common terminal of the control circuit. | — |
| | 10 10E | Power terminal for frequency setting | 5 V \pm 0.2 V DC Tolerable load current 10 mA 10 V \pm 0.4 V DC Tolerable load current 10 mA | Used as the power supply when the frequency setting (speed setting) volume is externally connected. (Terminal 5 is common.) | P58 |
| | 2 | Frequency setting (voltage signal) terminal | Input resistance 10 \pm 1 k Ω Max. tolerable voltage 20 V DC | When the input voltage of the terminal 2 is selected to be 5 V DC with 73, the maximum output frequency is gained at 5 V by inputting 0 - 5 V DC to terminal 2. Here, input is proportional to output. (An input voltage of 5 V or higher is regarded as 5 V.) When the input voltage of terminal 2 is selected to be 10 V DC with 73, the maximum output frequency is gained at 10 V by inputting 0 - 10 V DC to terminal 2. Here, input is proportional to output. | |

| Terminal code | Terminal name | Rating and others | Application | Reference page | |
|---------------------------------|---------------|---|--|---|-----|
| Control circuit (input signal) | 5 | Frequency setting input common terminal | — | The common terminal and control circuit of the frequency setting signal are 0 V. Ground the terminal. | — |
| | 1 | Frequency setting sub-input terminal | Input resistance 10 ± 1 k Ω Maximum tolerable voltage ± 20 V DC | When 0 to ± 10 V (± 5 V) DC is input, the maximum output frequency is gained at +10 V (+5 V) and -10 V (-5 V) in case of 73 (setting value 10~15). Here, input is proportional to output. In case of 73 (setting value 0~5), the maximum output frequency is gained at +10 V (+5 V), and the inverter is not output at 0 to -10 V (-5 V). It is added to the signal at the terminal 2. ± 10 V or ± 5 V is also switched with 73. | P61 |
| | 4 | Frequency setting (current signal) terminal | Input resistance 250 Ω $\pm 2\%$ Maximum tolerable current 30 mA | 4~20 mA DC is input. The maximum output frequency is gained at 20 mA DC. 0 Hz command is gained at 4 mA DC. | P16 |
| Control circuit (output signal) | B-C | Abnormal output terminal | Contact point output Contact point capacity | This contact point output indicates that the output of the inverter is shut down since the protective function of the inverter operates. Normally the circuit across B and C is closed, and the circuit across A and C is opened. In an abnormal situation the internal relay is activated to open the circuit across terminals B and C and close the circuit across terminals A and C. When this signal is output, the motor is brought into the free run state. | P88 |
| | A-C | | | | |
| | RUN | Inverter operation terminal | Open collector output Tolerable load 24 V DC 0.1 A | This open collector output is at the L level for the start frequency or more and at the H level for halt or DC brake. When the protective function is activated, it is at the H level. Use a power loading of 24 V DC with a ripple of $\pm 10\%$ or less (equivalent to 3-phase full wave rectification). | P88 |
| | SU* | Frequency arrival terminal | Open collector output Tolerable load 24 V DC 0.1 A | This open collector output is at the L level when the output frequency is within $\pm 10\%$ of the set frequency (factory-set at delivery. Variable with 40), and at the H level for acceleration-, deceleration and halt. Use a power loading of 24 V DC with a ripple of $\pm 10\%$ or less (equivalent to 3-phase full wave rectification). | P55 |
| | IPF* | Instantaneous power failure terminal | Open collector output Tolerable load 24 V DC 0.1 A | This open collector output is at the L level when the protective circuit is activated due to the instantaneous power failure or insufficient voltage. Use a power loading of 24 V DC with a ripple of $\pm 10\%$ or less (equivalent to 3-phase full wave rectification). | P55 |

* The function can be changed by setting the output terminal allocation function 40. (Page 11)

| Terminal code | Terminal name | Rating and others | Application | Reference page | |
|---------------------------------|-------------------------------|--|---|--|-----|
| Control circuit (output signal) | OL※ | Overload alarm terminal | Open collector output Tolerable load 24 V DC 0.1 A | This open collector output is at the L level when the current limit function or stall preventor is activated and at the H level when it is reset. The function of each terminal can be changed by setting the output terminal allocation setting function 40. Use a power loading of 24 V DC with a ripple of $\pm 10\%$ or less (equivalent to 3-phase full wave rectification). | P55 |
| | FU※ | Frequency detection terminal | Open collector output Tolerable load 24 V DC 0.1 A | This open collector output is at the L level when the output frequency is more than the detection frequency which is set with 42 (setting value: 0 to 400 Hz) and 43 (setting value: 0 to 400 Hz) and at the H level when it is less than the detection frequency. Use a power loading of 24 V DC with a ripple of $\pm 10\%$ or less (equivalent to 3-phase full wave rectification). | P55 |
| | SE | Open collector output common terminal | — | Common terminals of open collector outputs RUN, SU, OL, IPF and FU Insulated from the common terminal of the control circuit. | — |
| | FM | Terminal for indicator (frequency meter) | Photo-coupler insulation Tolerable load current 1 mA | Factory-set to become approx. 3.5 V DC (when circuit across FM and SD is opened) at 60 Hz, and is proportional to the output frequency. Connect to a 1 mA movable coil type DC ammeter. | P63 |
| | | | | The output pulse frequency becomes 1,440 pulses/sect for the frequency set by 55 (setting value 0 to 400 Hz) or the current set by 56 (setting value 0~3600 A). | |
| AM, 5 | Analog signal output terminal | Non-insulation 0 to 10 V DC Tolerable load current 1 mA (Load impedance 10 k Ω or more) Resolution power 8 bits | Factory-set to 10 V DC for the full scale value of each monitor, and is proportional to each monitor value. | P63 | |
| | | | The output voltage is set to be 10 V DC for the frequency set by 55 (setting value: 0 to 400 Hz) or the current set by 56 (setting value: 0 to 3600 A). | | |

16. OUTLINE DRAWINGS OF INVERTER CHASSIS UNIT AND DC REACTOR

MT-A140E-75K

Unit: mm (inches)

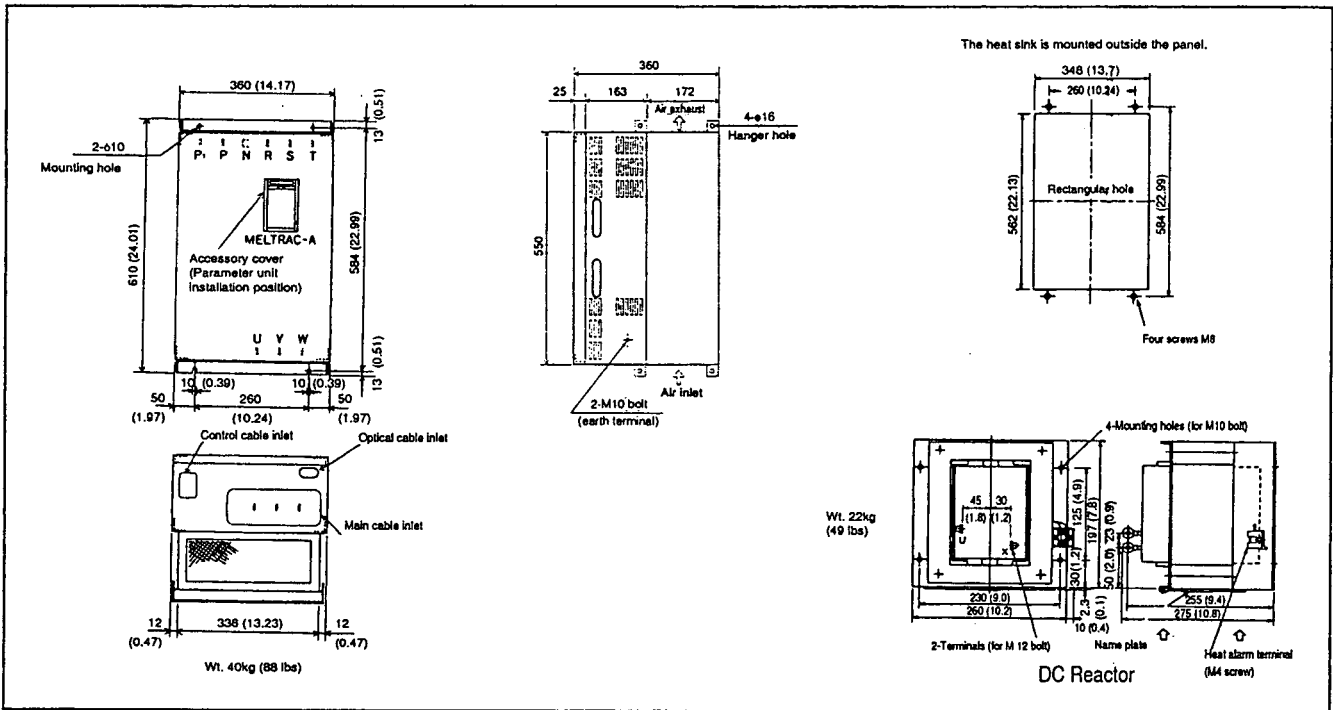

MT-A140E-110K • MT-A140E-150K

Unit: mm (inches)

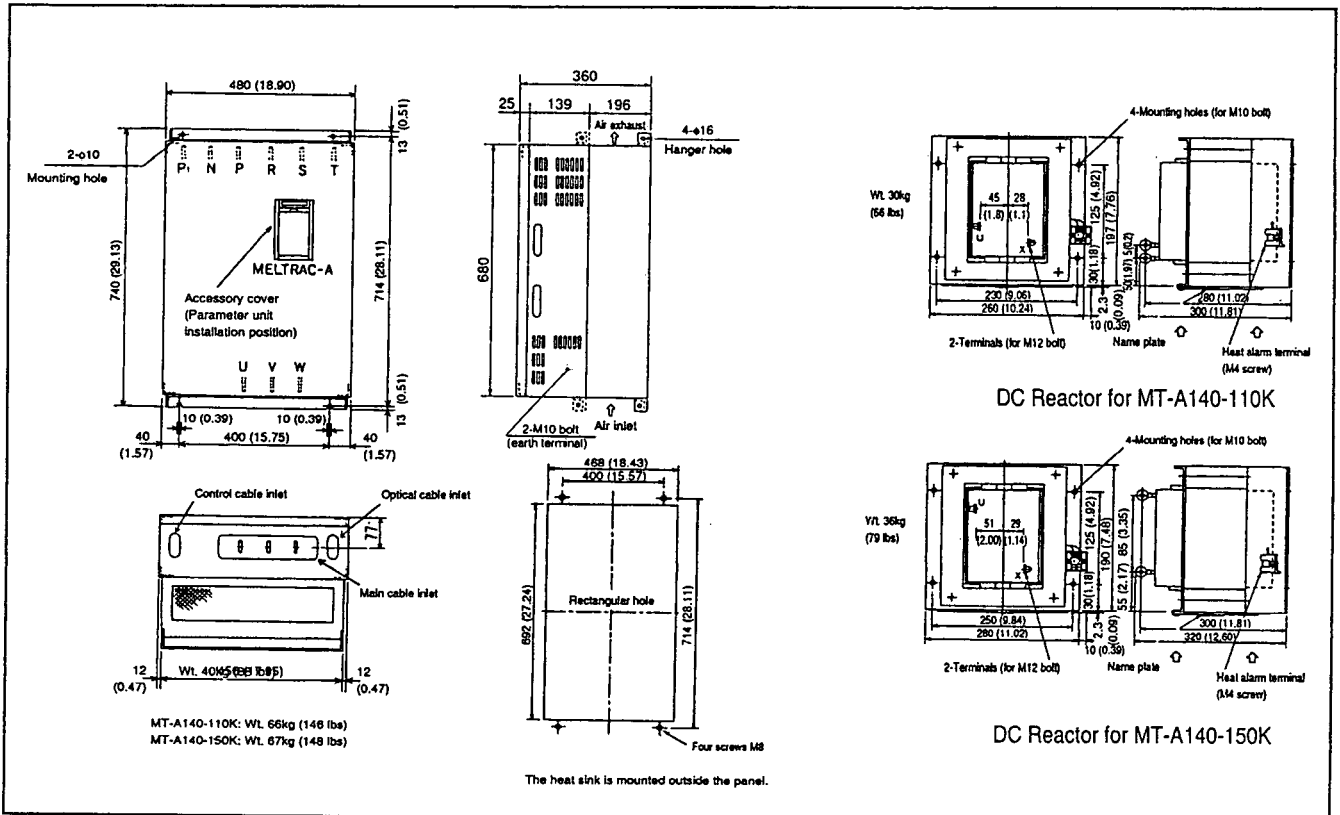

1. The R, S, and T on the source input and the DC reactor are connected on the top; and U, V, and W on the source output are connected on the bottom.
2. When the inverter heat sink is mounted outside the panel, less heat is generated internally. Thus, the overall unit size can be effectively reduced.
3. All units include a DC reactor to improve system power factor (DCL).

MT-A140E-220K

Unit: mm (inches)

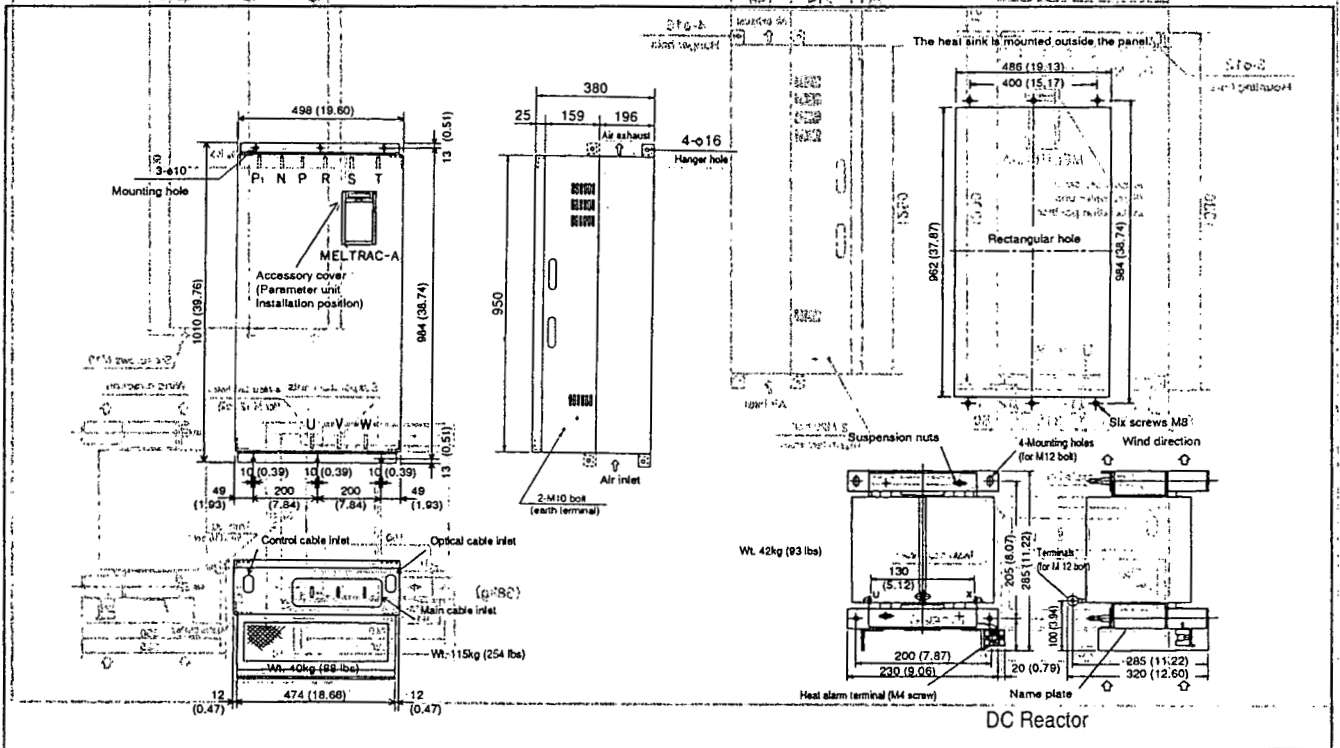

MT-A140E-280K

Unit: mm (inches)

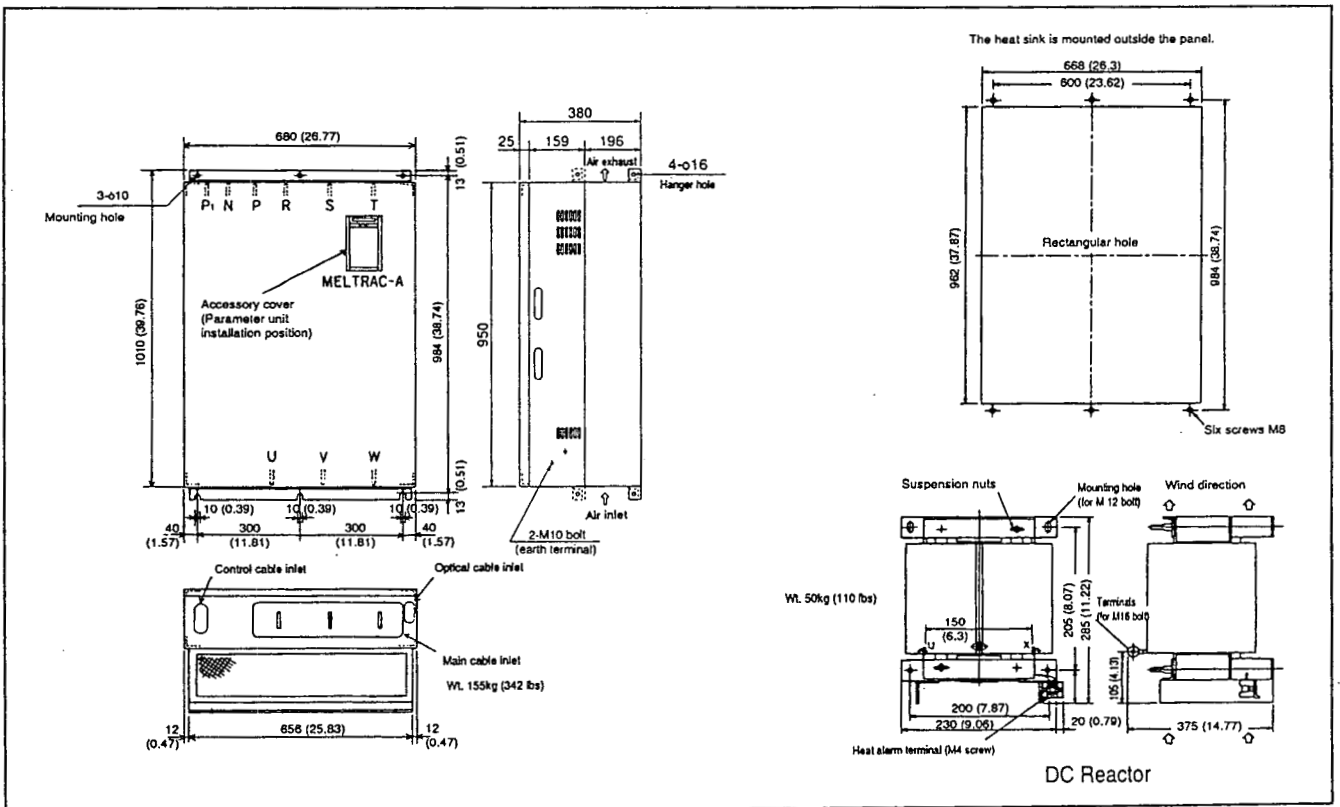

- Cool the DCL with forced air cooling at an minimum air velocity of 5m/sec (16ft/sec).
- DC reactor is equipped with temperature sensor. Please connect it to the auxiliary signal input terminal with normally open (NO) contact 0.6A, 125V. Temperature sensor for overtemperature alarm normally open contact. (0.6A, 125V)

MT-A140E-375K

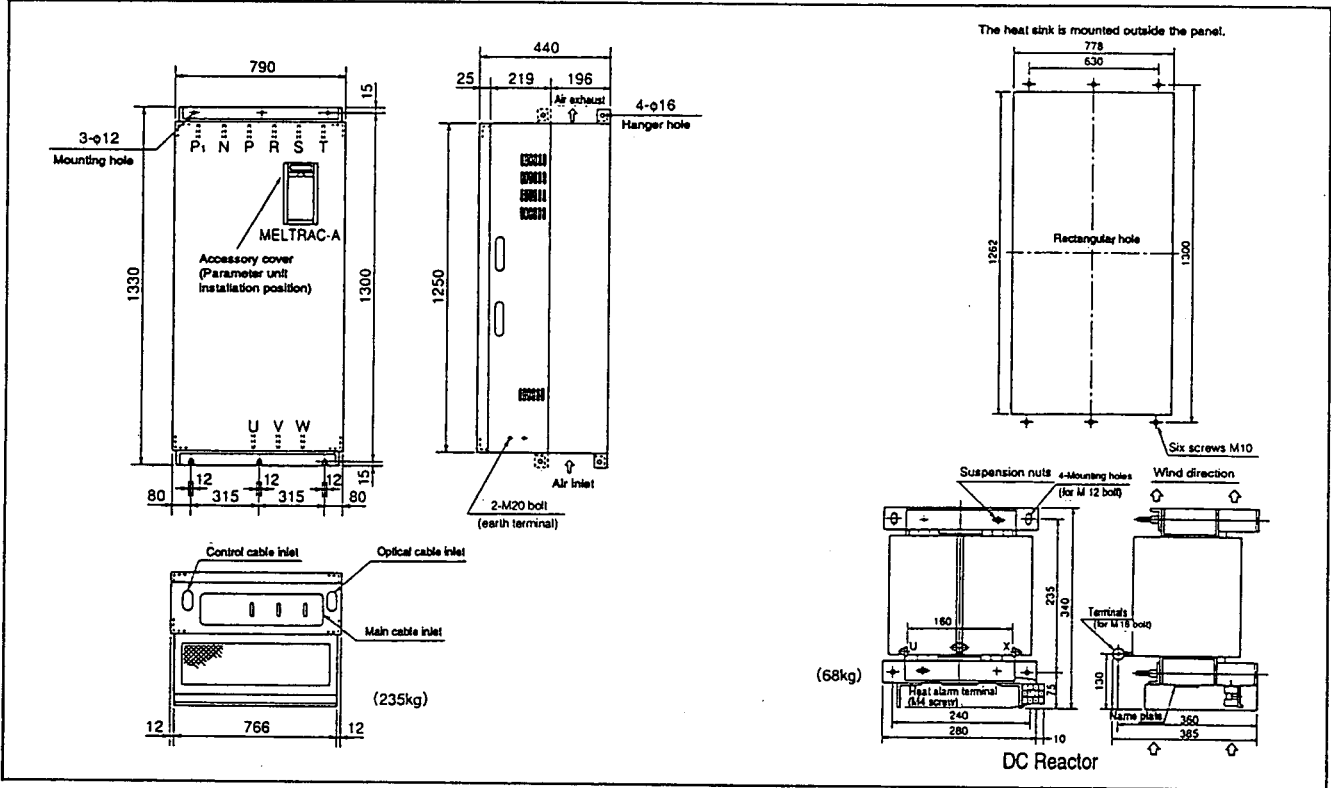

17. OPTION LIST

Main options

| Name | | Model | Application, specifications and others | Applicable inverter |
|--------------------------|------------------------------------|--|--|------------------------------|
| Built-in type | Input/output function | T-OPT20 | <ul style="list-style-type: none"> ● 16-bit digital input ● Relay output (4 points) ● Extended analog output (1 point) ● PLG feed-back control ● 12-bit A/D converter built-in for frequency command conversion | Common for all models |
| | Computer link | T-OPT21 | <ul style="list-style-type: none"> ● RS422 and RS485 interface for calculation link (serial communication) ● PLG feed-back control | |
| | PLC link | T-OPT22 | <ul style="list-style-type: none"> ● MELSCNET/MINI-S3 (fiber optic interface) ● PLG feedback control | |
| Detachable type | Parameter unit (in Japanese) | FR-PU02 | Interactive type parameter unit with LCD display Option necessary for inverter operation. | |
| | Parameter unit (in English) | FR-PU02E | LCD and numeric key pad of FR-PU02 are indicated in English Option necessary for inverter operation. | |
| Separate installing type | AC reactor for power coordination | | <ul style="list-style-type: none"> ● Necessary if the ratio of the power capacity to inverter capacity is 10 times or more and in the following cases <ul style="list-style-type: none"> ○ Thyristor converter load is applied to the same power supply. ○ The power factor adjusting capacitor is controlled to be on and off on the power side. ○ An imbalance of 3% or more exists in the power voltage. | Depends on inverter capacity |
| | Radio noise filter | FR-BIF | For radio noise reduction | Common for all models |
| | Line noise filter | FR-BLF | For radio noise reduction | |
| | Connection cable of parameter unit | FR-CBL | Parameter unit connection cable | |
| | Brake unit | MT-BU | Brake capacity increase of inverter | |
| | Resistor unit | MT-BR | A combination of the brake unit and the resistor unit is used. | |
| | Power regenerative converter | MT-RC | Energy-saving type high-performance brake unit in which the brake energy generated by the motor can be regenerated into the power supply | |
| Sine wave filter | MT-BSL/-BSC | Motor noise is reduced during inverter drive | Refer to Pr.72 | |

Functions of built-in options

Among the following option cards, one card can be stored in the inverter. Each card has multiple functions as shown below.

| Option name | Functions | | | | | | |
|---------------------------------|----------------------|----------------------|----------------------|-------------------------|----------------------------------|--------------------------------------|--|
| | PLG feedback control | 16-bit digital input | 12-bit A/D converter | Relay output (4 points) | Extended analog output (1 point) | Computer link (serial communication) | MELSECNET/ MINIS3 interface (PLC Link) |
| T-OPT20 (Input/output function) | √ | √ | √ | √ | √ | | |
| T-OPT21 (Computer link) | √ | | | | | √ | |
| (T-OPT22 PLC link) | √ | | | | | | √ |

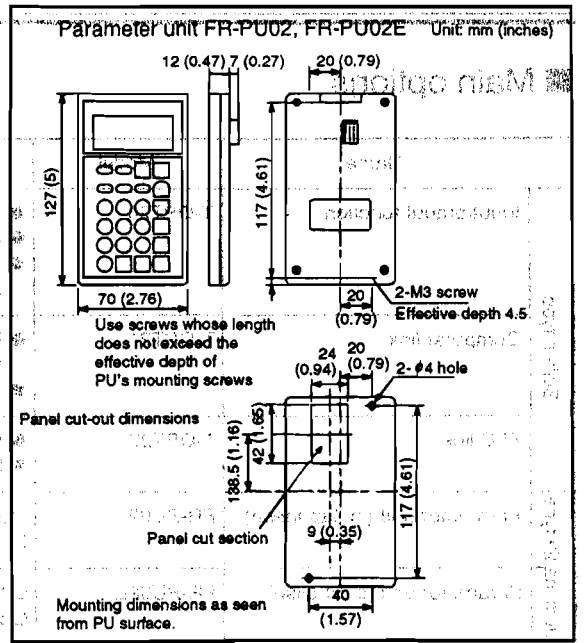
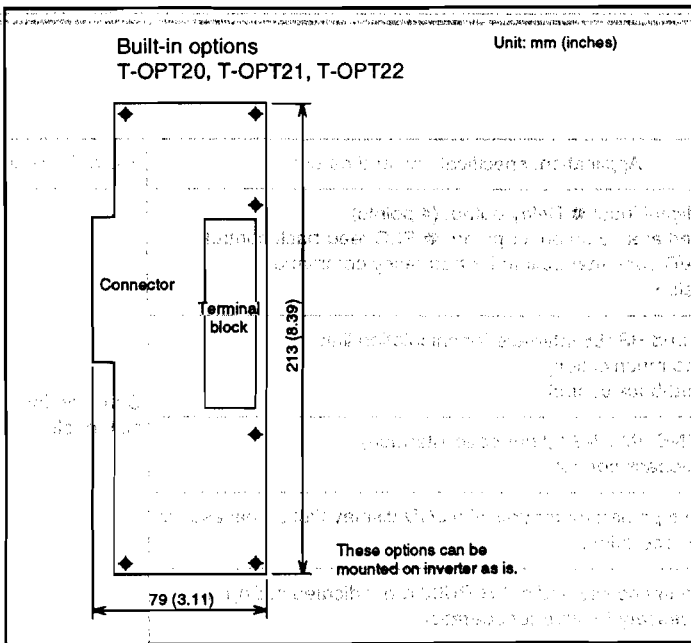

| Option | Description | Parameter | Value |
|---------|----------------------|-----------|----------|
| T-OPT20 | PLC feedback control | FR-PU02 | FR-PU02 |
| T-OPT21 | PLC digital input | FR-PU02 | FR-PU02 |
| T-OPT22 | PLC feedback control | FR-PU02E | FR-PU02E |
| T-OPT23 | PLC digital input | FR-PU02E | FR-PU02E |
| T-OPT24 | PLC feedback control | FR-PU02E | FR-PU02E |
| T-OPT25 | PLC digital input | FR-PU02E | FR-PU02E |
| T-OPT26 | PLC feedback control | FR-PU02E | FR-PU02E |
| T-OPT27 | PLC digital input | FR-PU02E | FR-PU02E |
| T-OPT28 | PLC feedback control | FR-PU02E | FR-PU02E |
| T-OPT29 | PLC digital input | FR-PU02E | FR-PU02E |
| T-OPT30 | PLC feedback control | FR-PU02E | FR-PU02E |
| T-OPT31 | PLC digital input | FR-PU02E | FR-PU02E |
| T-OPT32 | PLC feedback control | FR-PU02E | FR-PU02E |
| T-OPT33 | PLC digital input | FR-PU02E | FR-PU02E |
| T-OPT34 | PLC feedback control | FR-PU02E | FR-PU02E |
| T-OPT35 | PLC digital input | FR-PU02E | FR-PU02E |
| T-OPT36 | PLC feedback control | FR-PU02E | FR-PU02E |
| T-OPT37 | PLC digital input | FR-PU02E | FR-PU02E |
| T-OPT38 | PLC feedback control | FR-PU02E | FR-PU02E |
| T-OPT39 | PLC digital input | FR-PU02E | FR-PU02E |
| T-OPT40 | PLC feedback control | FR-PU02E | FR-PU02E |
| T-OPT41 | PLC digital input | FR-PU02E | FR-PU02E |
| T-OPT42 | PLC feedback control | FR-PU02E | FR-PU02E |
| T-OPT43 | PLC digital input | FR-PU02E | FR-PU02E |
| T-OPT44 | PLC feedback control | FR-PU02E | FR-PU02E |
| T-OPT45 | PLC digital input | FR-PU02E | FR-PU02E |
| T-OPT46 | PLC feedback control | FR-PU02E | FR-PU02E |
| T-OPT47 | PLC digital input | FR-PU02E | FR-PU02E |
| T-OPT48 | PLC feedback control | FR-PU02E | FR-PU02E |
| T-OPT49 | PLC digital input | FR-PU02E | FR-PU02E |
| T-OPT50 | PLC feedback control | FR-PU02E | FR-PU02E |

Factors of built-in options

Among the following options, you can select the needed built-in options as shown below.

| Option | PLC feedback control | PLC digital input | PLC A/D converter | PLC analog output (4 bits) | PLC analog output (12 bits) | PLC digital output (16 bits) | PLC digital output (16 bits) |
|----------|----------------------|-------------------|-------------------|----------------------------|-----------------------------|------------------------------|------------------------------|
| FR-PU02 | ✓ | ✓ | ✓ | ✓ | ✓ | ✓ | ✓ |
| FR-PU02E | ✓ | ✓ | ✓ | ✓ | ✓ | ✓ | ✓ |
| FR-PU02E | ✓ | ✓ | ✓ | ✓ | ✓ | ✓ | ✓ |
| FR-PU02E | ✓ | ✓ | ✓ | ✓ | ✓ | ✓ | ✓ |

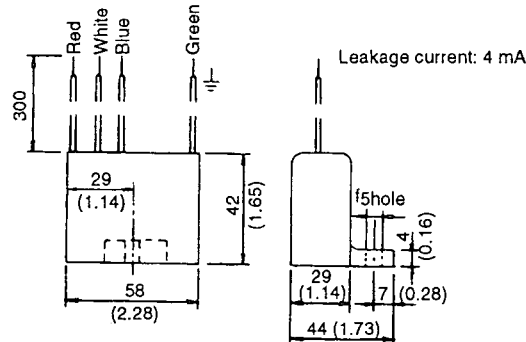
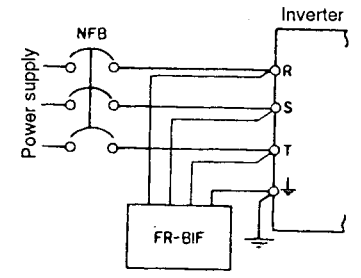
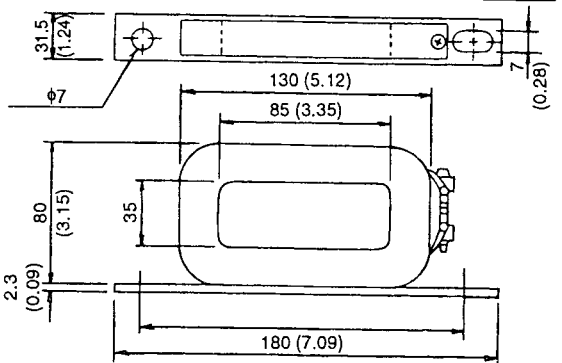
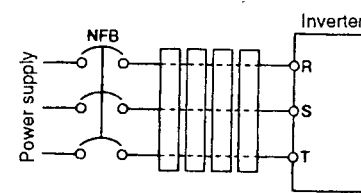
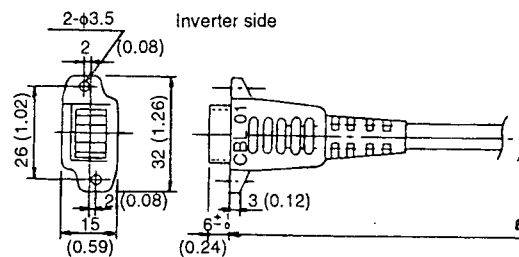
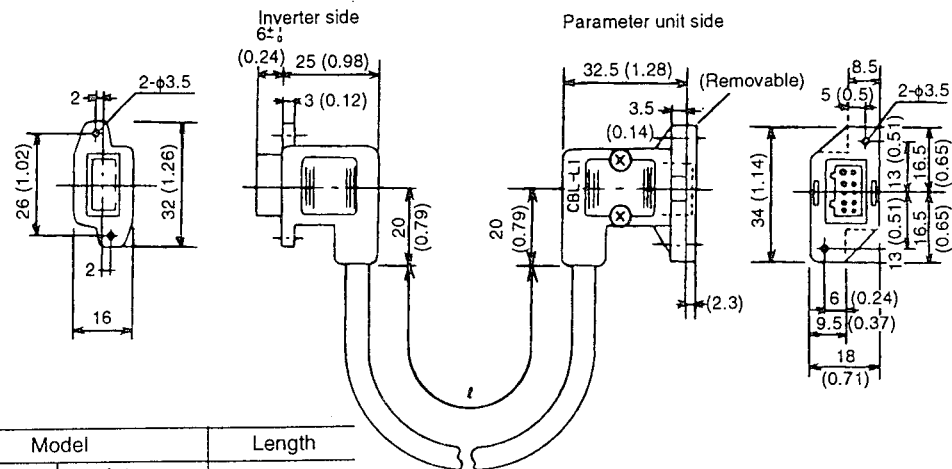
| Name (model name) | Specifications, structure and others | Remarks | | | | | | | | | | | | | | | |
|--|--|---|--|--------|---------------|--------|--|----------|-----------|---------|----------|-----------|---------|----------|-----------|--------|---|
| Radio noise filter FR-BIF...200V series FR-BIF-H...400V series |  <p>Leakage current: 4 mA</p> |  <p>Note: 1. It can not be connected to the output side of the inverter. 2. Cut the lead wires to the shortest possible length, and connect them to the terminal block of the inverter.</p> | | | | | | | | | | | | | | | |
| Line noise filter (FR-BLF) |  |  <p>Note: Pass the wires through four filters or more.</p> | | | | | | | | | | | | | | | |
| Cable for parameter unit (FR-CBL□) | <p>Straight type</p>  <p>L type</p>  <table border="1" data-bbox="285 1744 728 1915"> <thead> <tr> <th colspan="2">Model</th> <th>Length</th> </tr> </thead> <tbody> <tr> <td>Straight type</td> <td>L type</td> <td></td> </tr> <tr> <td>FR-CBL01</td> <td>FR-CBL-L1</td> <td>1 (3.2)</td> </tr> <tr> <td>FR-CBL03</td> <td>FR-CBL-L3</td> <td>3 (9.6)</td> </tr> <tr> <td>FR-CBL05</td> <td>FR-CBL-L5</td> <td>5 (16)</td> </tr> </tbody> </table> <p>Unit m (ft)</p> | Model | | Length | Straight type | L type | | FR-CBL01 | FR-CBL-L1 | 1 (3.2) | FR-CBL03 | FR-CBL-L3 | 3 (9.6) | FR-CBL05 | FR-CBL-L5 | 5 (16) | <p>The L type cable can be also fastened on the connector on the parameter unit side.</p> |
| Model | | Length | | | | | | | | | | | | | | | |
| Straight type | L type | | | | | | | | | | | | | | | | |
| FR-CBL01 | FR-CBL-L1 | 1 (3.2) | | | | | | | | | | | | | | | |
| FR-CBL03 | FR-CBL-L3 | 3 (9.6) | | | | | | | | | | | | | | | |
| FR-CBL05 | FR-CBL-L5 | 5 (16) | | | | | | | | | | | | | | | |



MITSUBISHI ELECTRIC CORPORATION

HEAD OFFICE : MITSUBISHI DENKI BLDG., MARUNOUCHI, TOKYO 100. TELEX : J24532 CABLE : MELCO TOKYO
NAGASAKI WORKS : 6-14 MARUO-MACHI, NAGASAKI, JAPAN TEL (095) 864-2580 TELEX : 7523-97 MELCO J