

Mitsubishi Electric SSCNET III/H compatible  
Motion Controller Q173DSCPU/Q172DSCPU  
Simple Motion Module QD77MS16/QD77MS4/QD77MS2

# SERVO SYSTEM CONTROLLER





Motion control in harmony with man, machine and





Most-advanced

SSCNET III/H compatible Motion controller  
**Q173DSCPU/Q172DSCPU**

Pursue Easy to use

SSCNET III/H compatible Simple Motion module  
**QD77MS16/QD77MS4/QD77MS2**

the environment

### **New-generation Motion Controller Debut**

Servo system controller have advanced to be safer for man, more flexible for various applications with our reliable technology. Now, Motion controller “Q17nDSCPU” and Simple Motion module “QD77MS” are released. We are confident with our new products in harmony with machine, man and the environment. With a safety-compliant system, with various functions for energy conservation, with high functionality, our Motion controller leads the future of Motion control.

# Harmony with machine, man, and the environment.

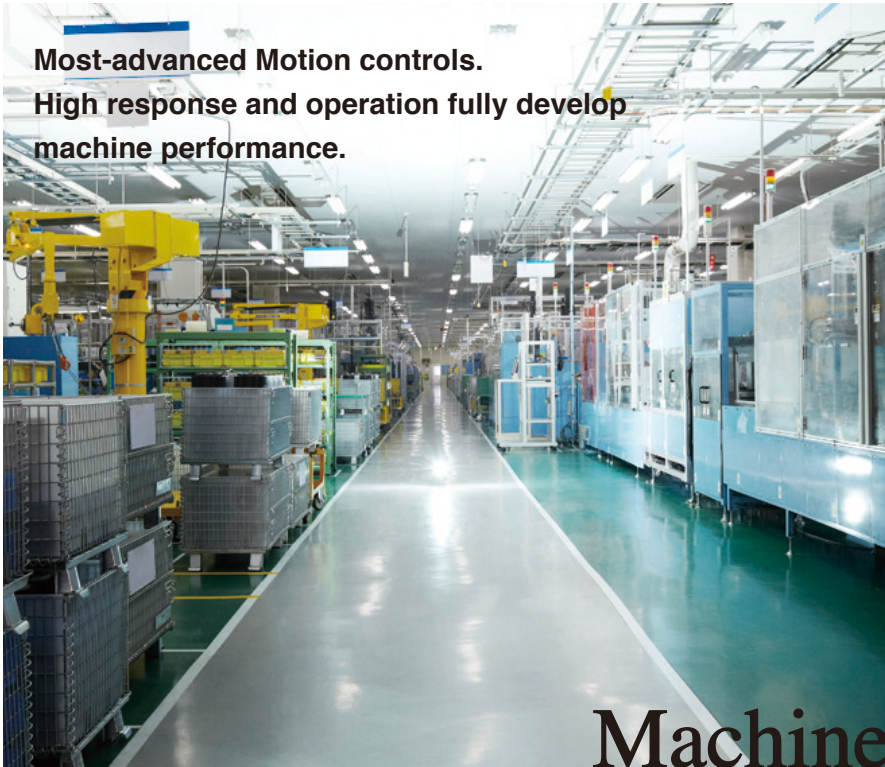

**Most-advanced Motion controls.  
High response and operation fully develop  
machine performance.**

## Machine

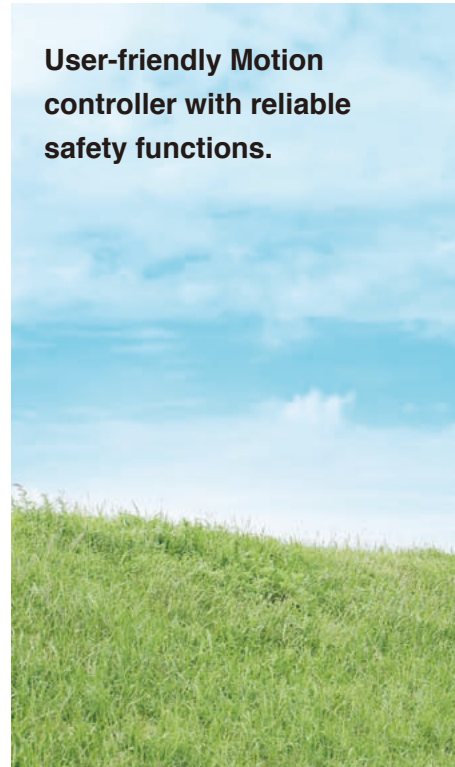

**User-friendly Motion controller with reliable safety functions.**

## Expand the applications

Now that high-mix low-volume production is a big trend in the market, Motion controller is expected to be used in various applications. "Q17nDSCPU" and "QD77MS" are capable of various controls such as positioning control, speed control, torque control, tightening & Press-fit control, synchronous control and cam control. They are applied to various machines such as X-Y tables, unwinding machines, packing machines and filling machines.

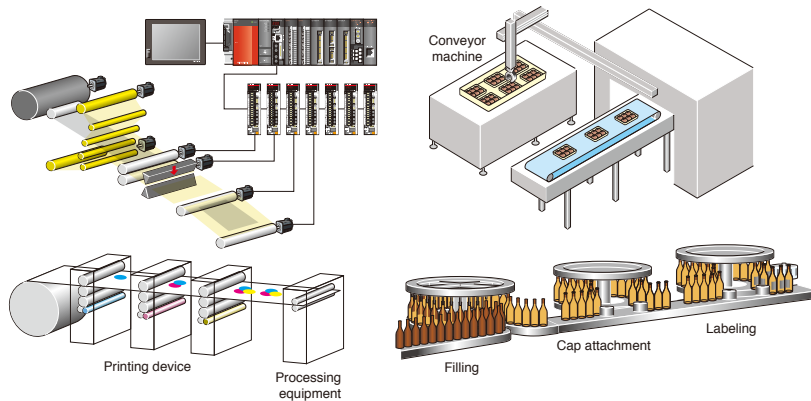

## Reliable Safety monitoring function

As ensuring safety in the production site is an absolute requirement, devices must comply with international safety standards. "Q17nDSCPU" has safety functions as standard which achieve the safety level PLd.

## User-friendly engineering environment

Pursuing Easy to Use. The powerful functions are aimed at creating user-friendly engineering environment such as design efficiency enhancement, debugging efficiency enhancement, reduced downtime, and data protection, etc.



## Heritage

### Highly compatible Motion controller with the conventional products

Motion Controller "Q17nDSCPU" and Simple Motion module "QD77MS" are highly compatible with the conventional servo amplifiers and Motion Controllers, so you can continue to use them.

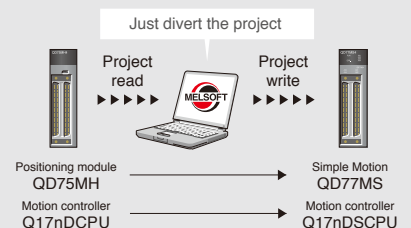



# New approach for future Motion controls.

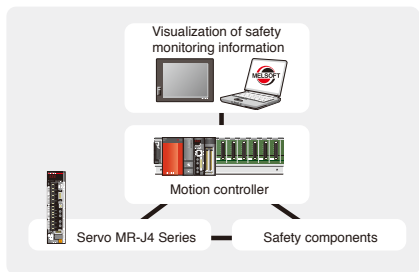

Safety components : Safety relay, CC-Link Safety compatible products, Contactor SD-Q Series

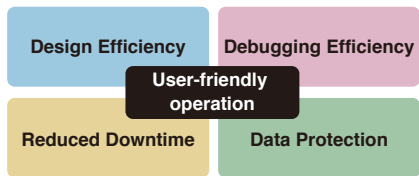

## Visualization of servo

For energy conservation, understanding the consumption of electric power is vital. "Q17nDSCPU" and "QD77MS" have the "optional data monitor function". Information such as motor current value, power consumption and total power consumption of the servo amplifier and servo motor are available via the SSCNET III/H. You can check those information on the screen to save the energy.

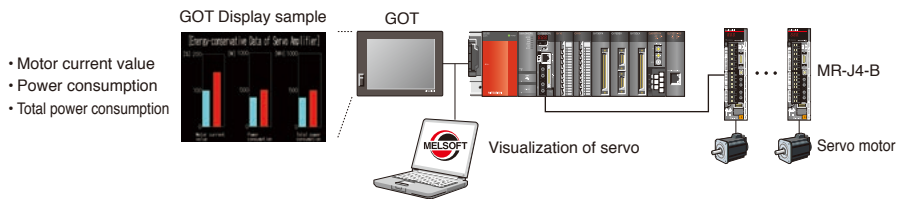

## Reduced wiring and space saving

Servo system controller with MR-J4 series dramatically reduce wiring and save space. With SSCNET III/H compatible servo amplifier, the number of wires is greatly reduced compared to the pulse train type. With the 3-axis servo amplifier, the installation space is reduced by approximately 30% compared to MR-J3-B.

## High compatibility with the conventional controllers

The Motion controller "Q17nDSCPU" and Simple Motion "QD77MS" are able to divert the projects from Motion controller "Q17nDCPU" and positioning module "QD75MH". There's no need to create new projects when replacing the modules.

## High compatibility with the conventional amplifiers

The SSCNET III/H compatible Motion controller and Simple Motion module are able to be connected to the SSCNET III compatible servo amplifier "MR-J3-B". Just place the new module into where the Motion controller "Q17nDCPU" and positioning module "QD75MH" was placed. The SSCNET III/H compatible servo amplifier "MR-J4-B" is also used with the SSCNET III compatible servo amplifier "MR-J3-B". You can continue to use the conventional servo amplifier.

# A complete system lineup to meet your production and manufacturing

Responding to expanding applications such as semiconductor and LCD manufacturing, packing machine, and cap tightening machine, collaborates with Mitsubishi Electric's product lines such as servo amplifiers, servo motors, servo system networks as well as displays Mitsubishi allows you to freely create an advanced servo system.

## HUMAN MACHINE I/F

### GOT1000



### Personal computer



## SOFTWARE



## CONTROLLER

### Q17nDSCPU



### iQ Platform Compatible Programmable Controllers



SSCNET III/H compatible Motion controller

**Q173DSCPU**  
**Q172DSCPU**

## NETWORK

### SSCNET III/H serial bus

## SERVO AMPLIFIER

### MR-J4 -B



SSCNET III/H compatible servo amplifier  
**MR-J4-B**



SSCNET III/H compatible 2-axis servo amplifier  
**MR-J4W2-B**



SSCNET III/H compatible 3-axis servo amplifier  
**MR-J4W3-B**

## SERVO MOTOR

### Rotary servo motor



Small capacity, low inertia  
**HG-KR series**  
Capacity: 50 to 750 W



Small capacity, ultra-low inertia  
**HG-MR series**  
Capacity: 50 to 750 W



Medium capacity, medium inertia  
**HG-SR series**  
Capacity: 0.5 to 7 kW

### Linear servo motor



Core type  
**LM-H3 series**  
Rating: 70 to 960 N



Core type with magnetic attraction counter-force  
**LM-K2 series**  
Rating: 120 to 2400 N

## SOLUTION



Mitsubishi Electric's integrated FA solution for achieving seamless information collaboration between information systems and control systems, and enabling lateral integration of production sites.







Motion controller and Simple Motion modules flexibly and programmable controllers via SSCNET III/H.

Motion controller engineering environment — MELSOFT **MT Works2**

PLC engineering software — MELSOFT **GX Works2**

Servo setup software — MELSOFT **MR Configurator2**

**Capacity selection software**

**QD77MS**

MELSEC-Q Series



SSCNET III/H compatible  
Simple Motion module

**QD77MS16**  
**QD77MS4**  
**QD77MS2**

**Direct drive motor**

Core type  
(natural/liquid cooling)  
**LM-F series**  
Rating: 300 to 1200 N  
(natural cooling)  
Rating: 600 to 2400 N  
(liquid cooling)

Coreless type  
**LM-U2 series**  
Rating: 50 to 800 N



**TM-RFM series**  
Rating: 2 to 240 N·m

Mitsubishi Electric's integrated FA platform for achieving lateral integration of controllers & HMI, engineering environments and networks at production sites.

**I N D E X**

■ Concept	.....	P03																	
■ System Configuration	.....	P05																	
■ SSCNETIII/H	.....	P07																	
■ Solution	.....	P09																	
■ Line up	.....	P11																	
■ Motion controller	<table border="1"> <tr> <td>Features</td> <td>.....</td> <td>P13</td> </tr> <tr> <td>System Configuration</td> <td>.....</td> <td>P15</td> </tr> <tr> <td>Main functions</td> <td>.....</td> <td>P17</td> </tr> <tr> <td>Programming</td> <td>.....</td> <td>P19</td> </tr> <tr> <td>Safety system</td> <td>.....</td> <td>P21</td> </tr> <tr> <td>Engineering environment</td> <td>.....</td> <td>P23</td> </tr> </table>	Features	.....	P13	System Configuration	.....	P15	Main functions	.....	P17	Programming	.....	P19	Safety system	.....	P21	Engineering environment	.....	P23
Features	.....	P13																	
System Configuration	.....	P15																	
Main functions	.....	P17																	
Programming	.....	P19																	
Safety system	.....	P21																	
Engineering environment	.....	P23																	
■ Simple Motion module	<table border="1"> <tr> <td>System Configuration</td> <td>.....</td> <td>P25</td> </tr> <tr> <td>Main functions</td> <td>.....</td> <td>P26</td> </tr> </table>	System Configuration	.....	P25	Main functions	.....	P26												
System Configuration	.....	P25																	
Main functions	.....	P26																	
■ MELSERVO-J4 series	.....	P31																	
■ Motion controller specifications	<table border="1"> <tr> <td>Control specification</td> <td>.....</td> <td>P35</td> </tr> <tr> <td>Motion CPU module</td> <td>.....</td> <td>P37</td> </tr> <tr> <td>Exterior Dimensions</td> <td>.....</td> <td>P39</td> </tr> <tr> <td>Configuration equipment</td> <td>.....</td> <td>P41</td> </tr> </table>	Control specification	.....	P35	Motion CPU module	.....	P37	Exterior Dimensions	.....	P39	Configuration equipment	.....	P41						
Control specification	.....	P35																	
Motion CPU module	.....	P37																	
Exterior Dimensions	.....	P39																	
Configuration equipment	.....	P41																	
■ Simple Motion module specifications	<table border="1"> <tr> <td>Control specification</td> <td>.....</td> <td>P43</td> </tr> <tr> <td>Exterior Dimensions</td> <td>.....</td> <td>P45</td> </tr> <tr> <td>Configuration equipment</td> <td>.....</td> <td>P46</td> </tr> </table>	Control specification	.....	P43	Exterior Dimensions	.....	P45	Configuration equipment	.....	P46									
Control specification	.....	P43																	
Exterior Dimensions	.....	P45																	
Configuration equipment	.....	P46																	
■ Global support system	.....	P47																	
■ Development/ production and SSCNET Partner Association	.....	P49																	
■ About warrantee	.....	P50																	

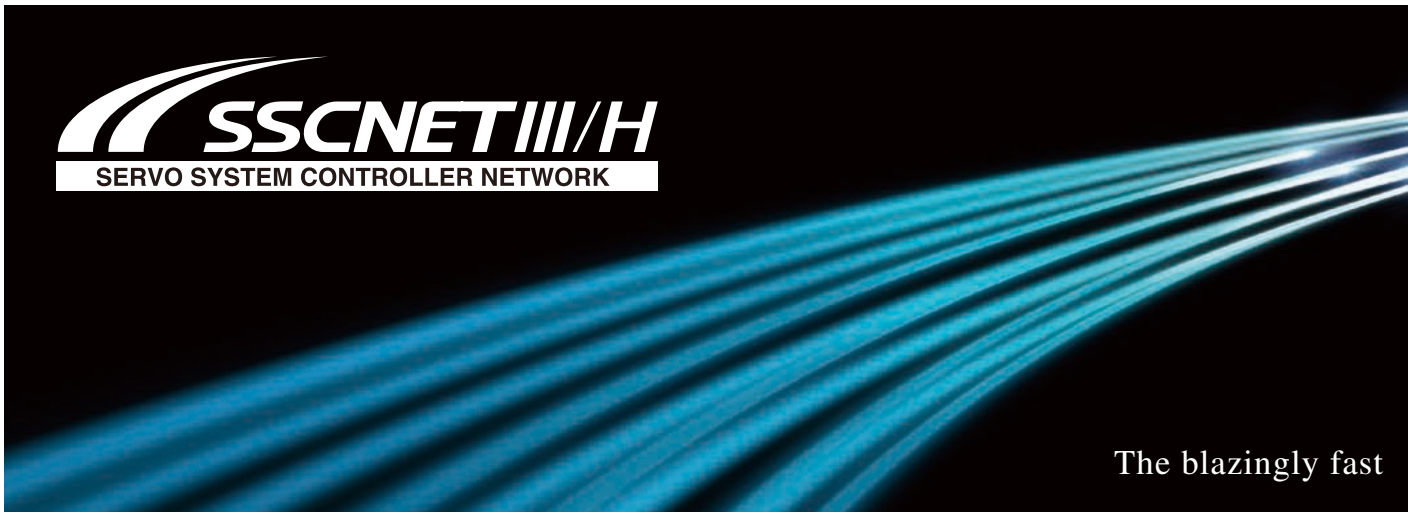

The blazingly fast

**MELSERIO-J4** | High-response system achieved with SSCNET III/H

**Three times faster communication speed** Industry-leading levels

Communication speed is increased to 150 Mbps full duplex (equivalent to 300 Mbps half duplex), three times faster than the conventional speed. System response is dramatically improved.

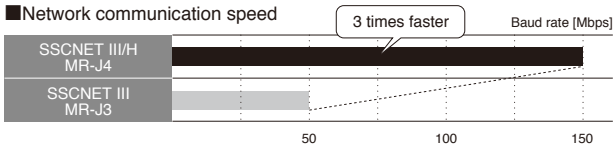

**High performance of machine achieved with synchronized communication**

Complete synchronized communication is achieved with SSCNET III/H, offering technical advantages in machines such as printing and food processing machines that require synchronous accuracy.

■ Timing of servo amplifier processing

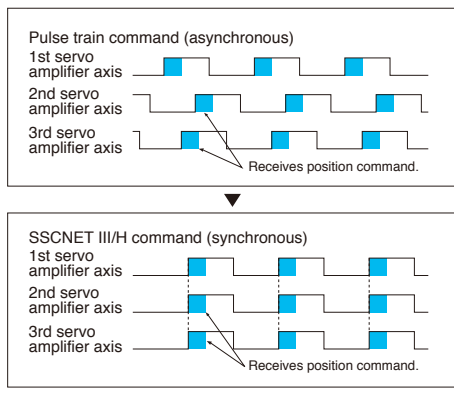

**Cycle times as fast as 0.22 ms** Industry-leading levels

Smooth control of machine is possible using high-speed serial communication with cycle times of 0.22 ms.

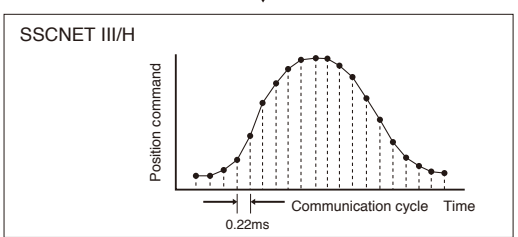
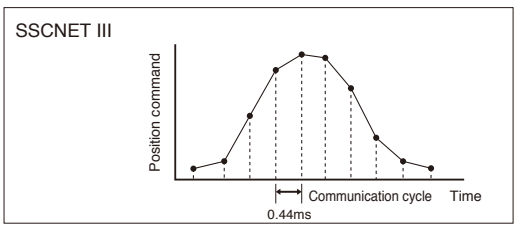

**Improved noise immunity with the optical communication**

The fiber-optic cables thoroughly shut out noise that enters from the power cable or external devices. Noise immunity is dramatically improved as compared to metal cables.

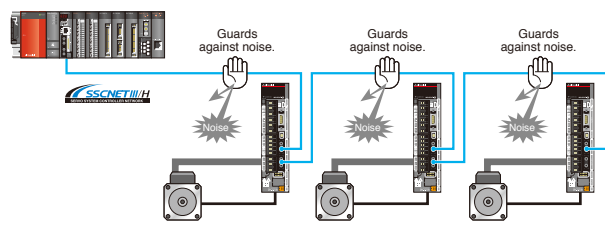



# speed and response of 150 Mbps full-duplex baud rate SSCNET III/H optical networking

## Dramatically reduced wiring

Simple connections with dedicated cables reduce both wiring time and chances of wiring errors. No more complicated wiring.

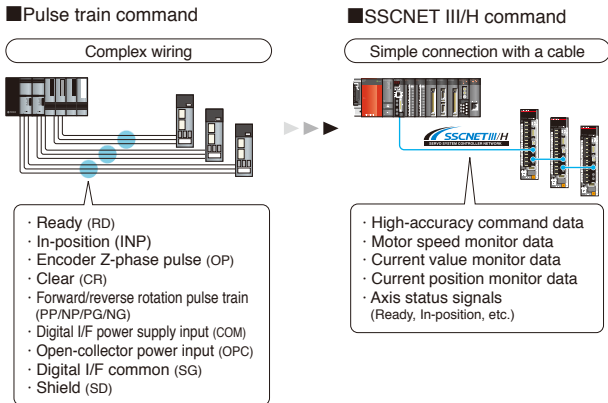

## Central control with network

Large amounts of servo data are exchanged in real-time between the controller and the servo amplifier. MR Configurator2 is used on a personal computer that is connected to Q17nDSCPU or QD77MS. Information for multiple servo amplifiers is consolidated.

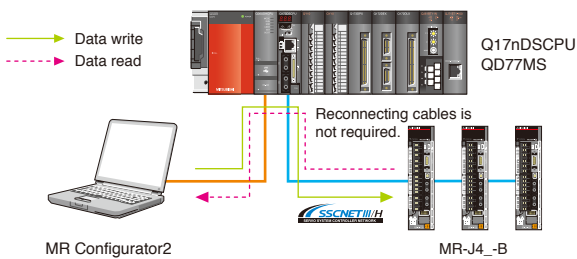

## Long distance wiring up to 1600 m (5249.28 ft.)

Enhanced functions

Long distance wiring is possible up to 1600 m (5249.28 ft.) per system (maximum of 100 m (328.08 ft.) between stations x 16 axes). Thus, it is suitable for large-scale systems.

\* This is when all axes are connected via SSCNET III/H.

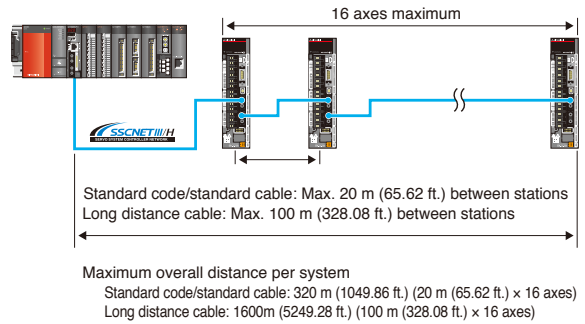

## SSCNET III/H compatible and SSCNET III compatible products connected in a same system

SSCNET III/H compatible and SSCNET III compatible servo amplifiers are connected in a same system.

\* When using SSCNET III/H compatible and SSCNET III compatible products together, the communication speed is 50 Mbps, and the function and performance are equivalent to when using MR-J3.

■ Communication speed: 150Mbps

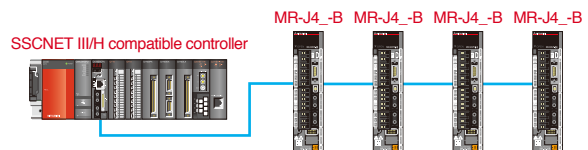

■ Communication speed: 50 Mbps

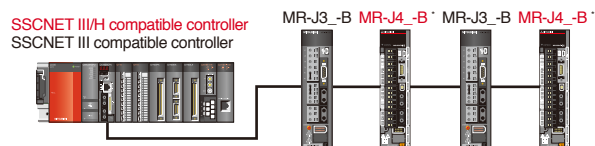



## Q17nDSCPU & QD77MS solutions for advanced Motion control

### Solution

#### CASE1 | Packing machine (synchronous control, cam control, mark detection function)

**Q17nDSCPU** **QD77MS**

When packing foods, etc., each process is synchronized by using synchronous control and cam control. Materials is cut using the register mark as a reference with mark detection function.

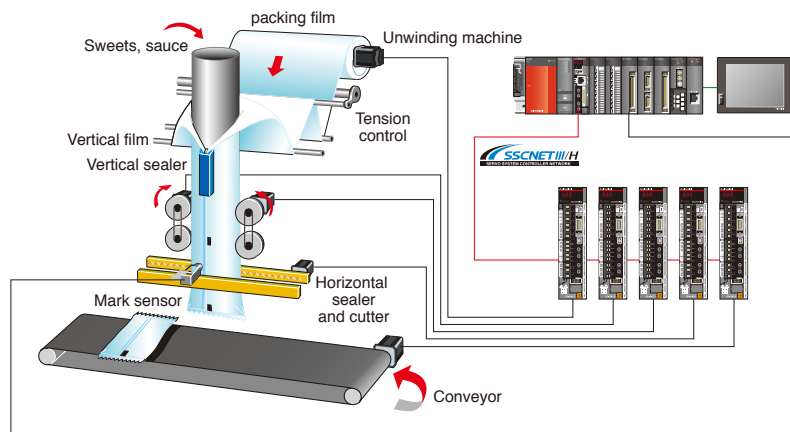

#### CASE2 | Conveyor machine (advanced S-curve acceleration/deceleration function)

**Q17nDSCPU**

Vibration is minimized and a short tact time is achieved with the advanced S-curve acceleration/deceleration function, which sets the interval of smooth acceleration and the interval of acceleration at the maximum speed.

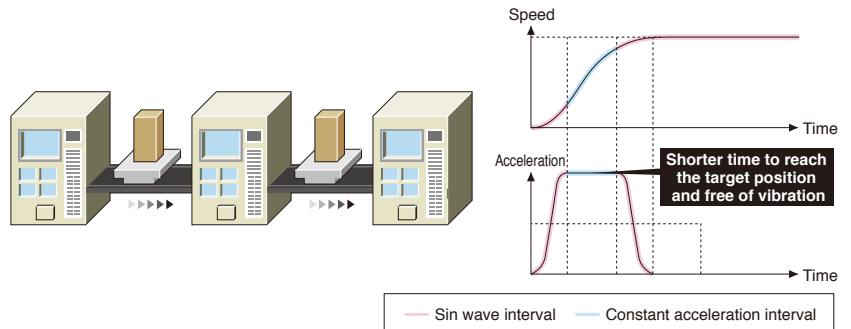

#### CASE3 | Alignment System (Ethernet connection, Vision system, Target position change function)

**Q17nDSCPU**

COGNEX Vision System is connected to the built-in PERIPHERAL I/F of Motion CPU with Ethernet. Alignment time is reduced with target position change function which uses the work piece position data from Vision System for high-speed Motion control.

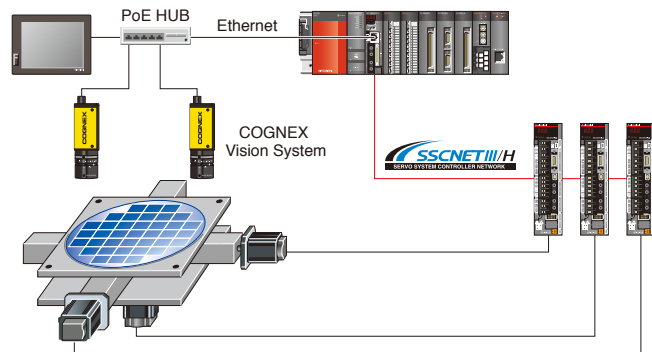



CASE4

**Cap tightening machine** (Position control, Torque control, Tightening & Press-fit control)

Q17mDSCPU

QD77MS

Control mode is able to be switched, such as from position control to torque control or torque control to positioning control. Tightening & Press-fit control, which switches from positioning control to torque control without stopping during positioning, is also available. The absolute position is stored even the machine is in control modes except position control, so positioning is carried out smoothly even after switching to positioning control.

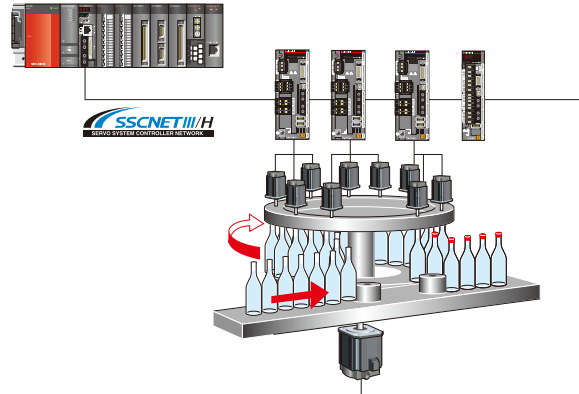

CASE5

**Safety System** (Safety signal comparison function)

Q17mDSCPU

Safety systems is simply structured using the light curtain, forced stop button or safety fence, etc.

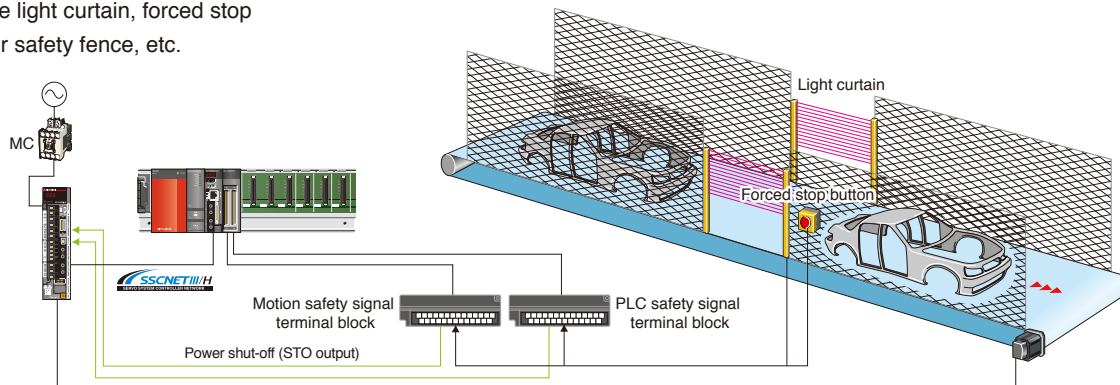

CASE6

**Visualization of servo** (Optional data monitor function)

Q17mDSCPU

QD77MS

The motor current value, power consumption and total power consumption of the servo amplifier and servo motor via SSCNET III/H are visible on the user-designed graphic operation terminal screen. You can check the power consumption to save the energy.

<Display example>

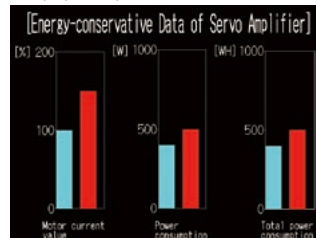

- Motor current value
- Power consumption
- Total power consumption

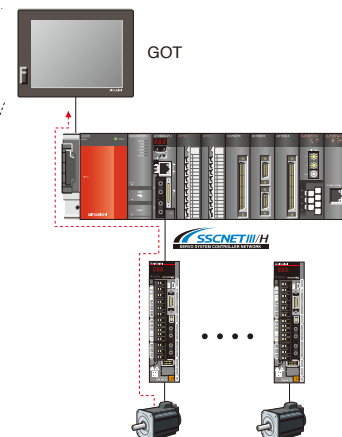



## Harmony with wide range of applications and controls

### Line up

### Features of Motion Controller and Simple Motion Module



**Most-advanced Motion controller**

SSCNET III/H compatible Motion controller

**Q173DSCPU**  
**Q172DSCPU**

Motion controller is a CPU module used with PLC CPU for Motion control. High speed control is achieved as Motion controller with Motion SFC program independently control modules, such as input/output modules, from PLC CPU.

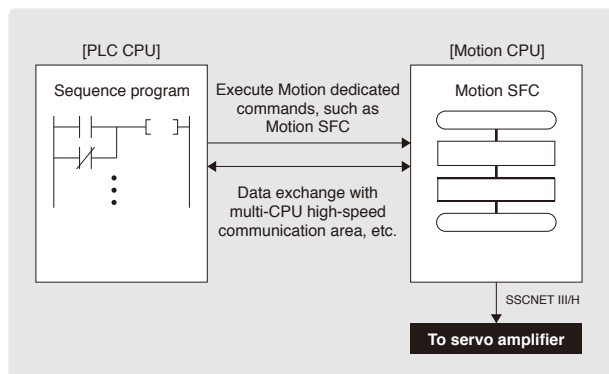

**Advanced but simple as a positioning module**

SSCNET III/H compatible Simple Motion module

**QD77MS16**  
**QD77MS4**  
**QD77MS2**

Simple Motion module is an intelligent function module controlled by PLC CPU, which easily perform positioning control. Synchronous control that was previously unavailable with the conventional positioning module is now available with this Simple Motion module just like the positioning module.

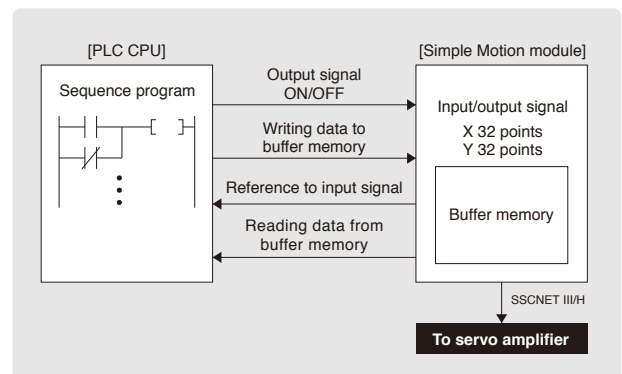



## Comparison of Motion controller and Simple Motion module

■ Superior

	Motion controller			Simple Motion module		
	Q173DSCPU	Q172DSCPU		QD77MS16	QD77MS4	QD77MS2
Module type	CPU module			Intelligent Function Module		
Servo amplifier interface	SSCNET III/H <b>NEW</b>			SSCNET III/H <b>NEW</b>		
	2 systems	1 system		1 system		
Servo amplifier type	MR-J4-B <b>NEW</b>			MR-J4-B <b>NEW</b>		
Number of control axes	32 axes	16 axes <b>NEW</b>		16 axes <b>NEW</b>	4 axes	2 axes
Operation cycle	0.22 ms or more			0.88ms / 1.77ms		
Engineering environment	MT Works2	MR Configurator2	(Note-1)	Simple Motion Module Setting Tool	MR Configurator2	(Note-2)
Programming language	Motion SFC			—		
Control modes	Position control	Speed control <b>NEW</b>	Torque control <b>NEW</b>	Position control	Speed control <b>NEW</b>	Torque control <b>NEW</b>
	Tightening & Press-fit control <b>NEW</b>	Synchronous control	Cam control	Tightening & Press-fit control <b>NEW</b>	Synchronous control <b>NEW</b>	Cam control <b>NEW</b>
Positioning control	Linear interpolation	Circular interpolation	Trajectory control	Linear interpolation	Circular interpolation	Trajectory control
	Helical interpolation	Position follow-up control	Speed control with fixed position stop			Speed/position switching control (ABS)
	High-speed oscillation control	Speed/position switching control		Speed/position switching control (INC)	Position-speed switching control	
Acceleration/deceleration control	Automatic trapezoidal acceleration/deceleration	S-curve acceleration/deceleration	Advanced S-curve acceleration/deceleration	Automatic trapezoidal acceleration/deceleration	S-curve acceleration/deceleration	
Manual control	JOG operation	Manual pulse generator operation		JOG operation	Manual pulse generator operation	
	JOG operation simultaneous start				Inching operation	
Functions to change the control details	Current value change	Target position change function <b>NEW</b>	Torque limit value change	Current value change	Target position change function	Torque limit value change
	Speed change			Speed change	Override	Acceleration/deceleration time change
Home position return type	Proximity dog type 1	Proximity dog type 2	Scale home position signal detection type	Proximity dog type		Scale home position signal detection type <b>NEW</b>
	Count type 1	Count type 2	Count type 3	Count type 1	Count type 2	
	Data set type 1	Data set type 2	Dog cradle type	Data set type		
	Stopper type 1	Stopper type 2	Limit switch combined type			
Sub functions	Forced stop function	Hardware stroke limit function	Software stroke limit function	Forced stop function	Hardware stroke limit function	Software stroke limit function
	Absolute position system	Amplifier-less operation function	Unlimited length feed function	Absolute position system	Amplifier-less operation function <b>NEW</b>	Unlimited length feed function
	Optional data monitor function	Mark detection function	ROM operation function	Optional data monitor function <b>NEW</b>	Mark detection function <b>NEW</b>	Flash ROM backup
	M-code output function	Error history	Digital oscilloscope function	M-code output function	Error history <b>NEW</b>	Digital oscilloscope function <b>NEW</b>
	Safety observation function <b>NEW</b>	Vision sensor connection	Software security key function <b>NEW</b>			
	High-speed reading function	Limit switch output function				Cam auto-generation function <b>NEW</b>

(Note-1) : MELSOFT MR Configurator2 is included in MELSOFT MT Works2.

(Note-2) : The Simple Motion module setting tool is included in MELSOFT GX Works2.

# Most-advanced Motion controller

SSCNET III/H compatible Motion

Reduced wiring, various basic functions, multiple CPU control-All for customer needs.

## Multiple CPU control by PLC CPU and Motion CPU

Q17mDSCPU

Loads are dispersed by distributing tasks such as servo control, machine control, and information control among multiple processors. By selecting the Motion CPU and PLC CPU according to the application, a flexible system is configured. The program of Motion CPU is described in the Motion SFC program.

[Multiple CPU High Speed Bus] Maximum of 14k words are transferred every 0.88ms by the dedicated multiple CPU high speed bus. The Multiple CPU high speed transmission cycle is synchronized with the Motion control cycle thus optimizing the control system.

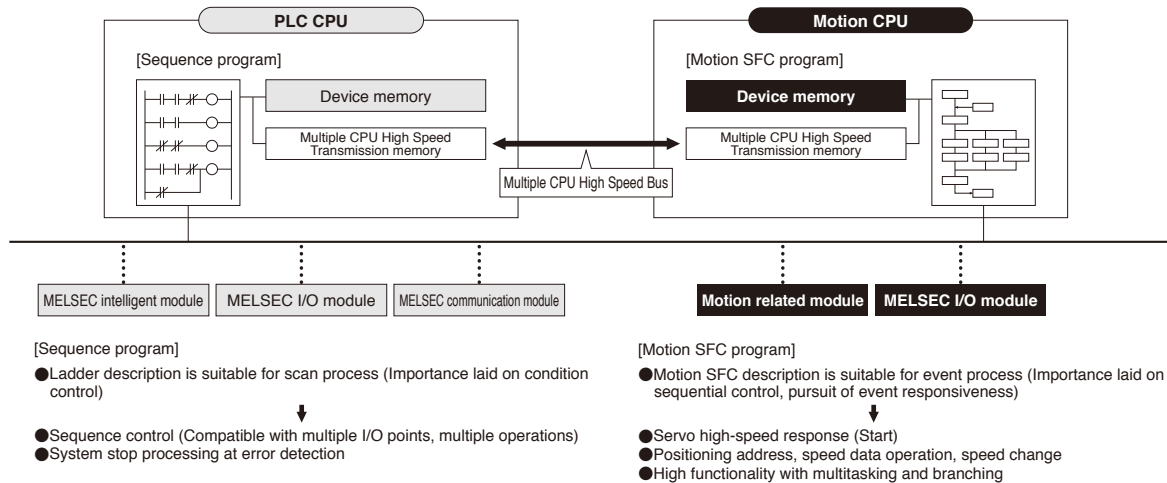

## Control flow

Q17mDSCPU

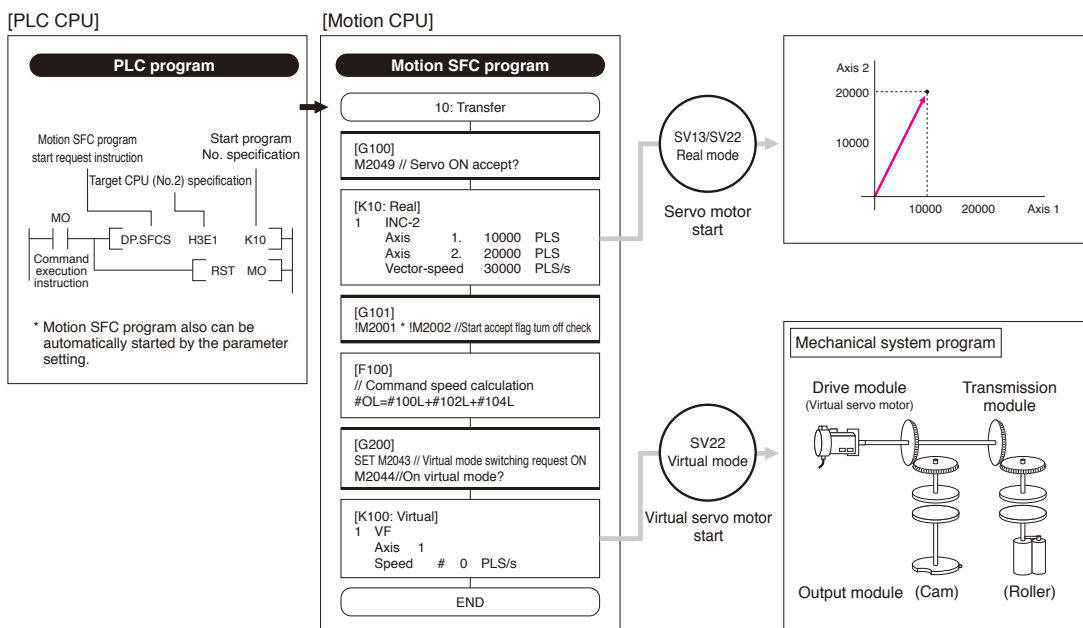



# Q173DSCPU/Q172DSCPU



Faster response time for shorter tact time

## Operation Cycle of 0.22 ms/4 axes

Q17mDSCPU

We have achieved a Motion operation cycle of 0.22 ms /4 axes to meet the needs for a shorter tact time. Even at an operation cycle of 0.44 ms, up to 10 axes is controlled without losing the high response.

<Perfect for smooth curve control>

The command data from the Motion controller is transmitted to the servo amplifier every 0.22 ms. Motion Controller with Servo amplifier (MR-J4-B) and servo motor (HG-KR motor: 4194304PLS/rev) achieve the shorter operation cycle and smooth motion.

	Operation cycle	
	0.22 ms	0.44 ms
Q173DSCPU	4 axes	10 axes
Q173DCPU	—	6 axes

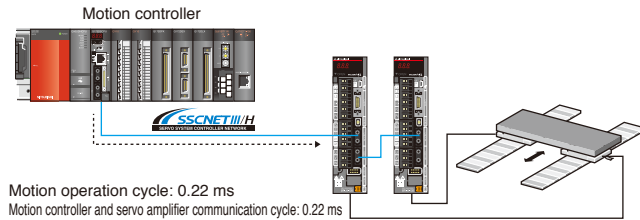

Motion controller with MR-J4 series greatly reduces wiring

## Reduced wiring, space saving

Q17mDSCPU QD77MS

The number of wires and parts is drastically reduced when Motion controller is used with MR-J4 Series 2-axis servo amplifier or 3-axis servo amplifier. When Motion controller is used with the 3-axis amplifier "MR-J4W3-B", the installation space is reduced by approximately 30%.

[Reduced wiring]

**MR-J4-B × 3 units**

No. of wires  
Reduced by  
**50%**

**[Number of wires]**

SSCNETIII cable	×3
Main circuit power supply	×3
Control circuit power supply	×3
Magnetic contactor connection	×3
Magnetic contactor control	×3
Encoder	×3
Motor power input	×3
<b>Total</b>	<b>21 wires</b>

**MR-J4W3-B (3-axis integrated type) × 1 unit**

**[Number of wires]**

SSCNETIII cable	×1
Main circuit power supply	×1
Control circuit power supply	×1
Magnetic contactor connection	×1
Magnetic contactor control	×1
Encoder	×3
Motor power input	×3
<b>Total</b>	<b>11 wires</b>

[Space saving]

**MR-J4-B × 3 units**

**[Number of parts]**

Servo amplifier	×3
Servo motor	×3
Molded case circuit breaker	×3
Magnetic contactor	×3

**MR-J4W3-B (3-axis integrated type) × 1 unit**

**[Number of parts]**

Servo amplifier	×1
Servo motor	×3
Molded case circuit breaker	×1
Magnetic contactor	×1



# Multiple CPU system for high-speed Motion control

## System Configuration

**Q17nDSCPU**

- Compatible with the Q Series PLC (Platform) in the Multiple CPU system.
- You can select Motion CPU and PLC CPU according to your application.
- The Multiple CPU system is capable of using up to four CPU modules. (one PLC CPU must be used.)
- Over 100 modules of Q series are available, and enhance system scalability.
- Up to 96 axes of servo motors are controlled by using three modules of Q173DSCPU.

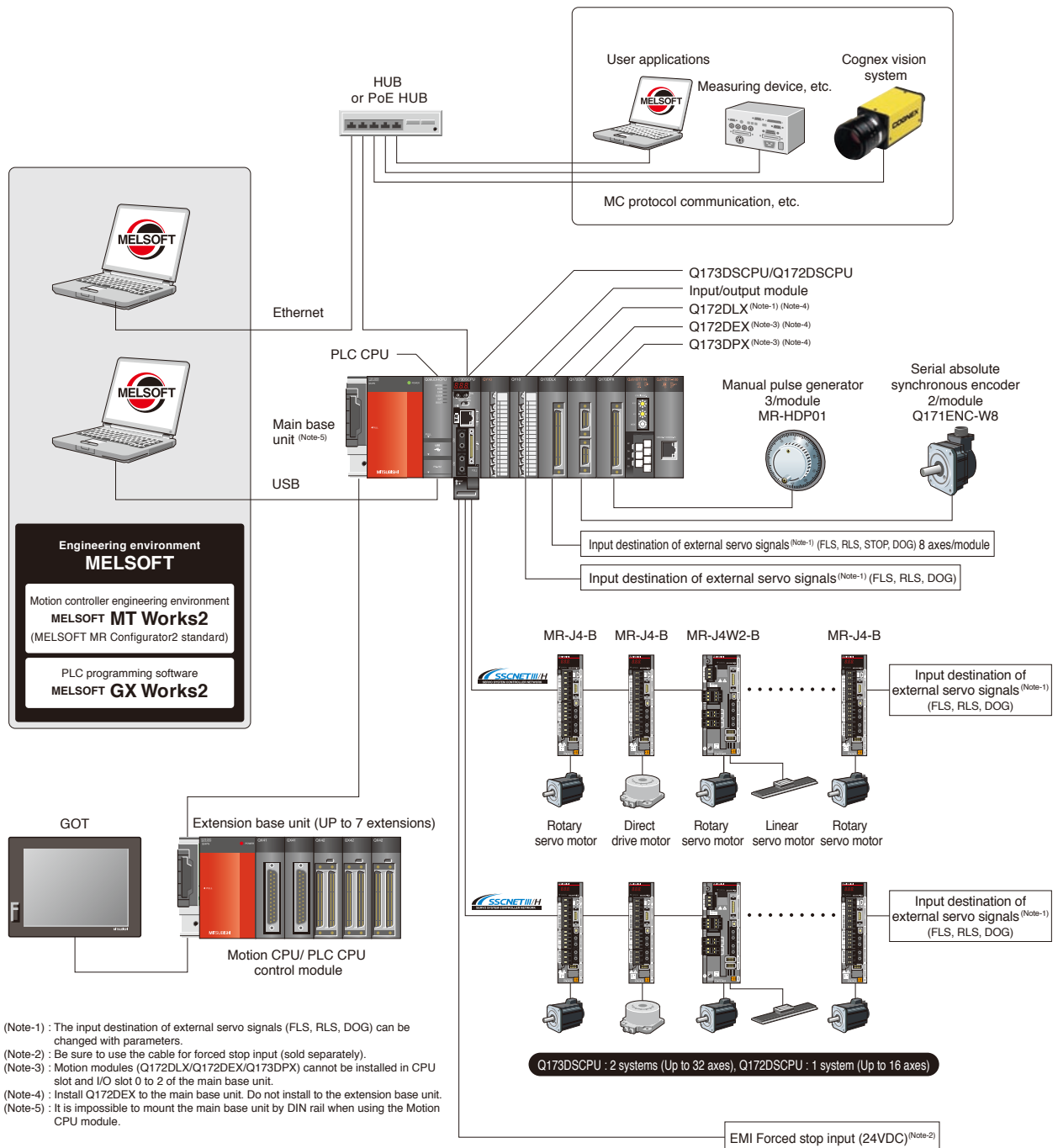

(Note-1) : The input destination of external servo signals (FLS, RLS, DOG) can be changed with parameters.  
 (Note-2) : Be sure to use the cable for forced stop input (sold separately).  
 (Note-3) : Motion modules (Q172DLX/Q172DEX/Q173DPX) cannot be installed in CPU slot and I/O slot 0 to 2 of the main base unit.  
 (Note-4) : Install Q172DEX to the main base unit. Do not install to the extension base unit.  
 (Note-5) : It is impossible to mount the main base unit by DIN rail when using the Motion CPU module.

## Operating System Software Package (SV22 is pre-installed before shipment)

Q17nDSCPU

Motion SFC programs and mechanical system programs are available for the Motion controllers. In Motion SFC programs editing, machine operation procedure is described with flow chart format. In mechanical system program editing, mechanical modules are placed on screen such as the virtual servo motor, gears, cams and rollers, etc.

<Automatic machinery use SV22>

<Conveyor assembly use SV13>

### Servo program

- Electronic component assembly
- Feeder
- Molder
- Conveying equipment
- Paint applicator
- Chip mounting
- Wafer slicer
- Loader and Unloader
- Bonding machine
- X-Y table

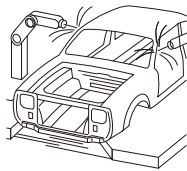

- Circular interpolation
- Constant-speed control
- Fixed-pitch feed
- Speed control with fixed position stop
- Speed switching control
- Speed/position switching control
- Linear interpolation control (1 to 4 axes)
- Teaching

2 axes positioning

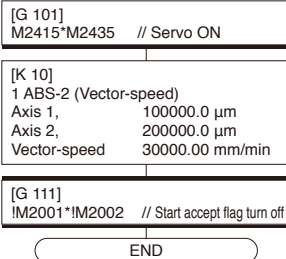

### Mechanical system program

- Press feeder
- Food processing
- Food packaging
- Winding machine
- Spinning machine
- Textile machine
- Knitter
- Printing machine
- Book binder
- Tire molder
- Paper-making machine
- Synchronous control
- Electronic shaft
- Electronic clutch
- Electronic cam
- Draw control

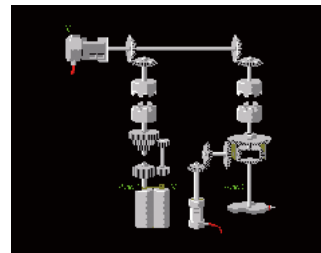
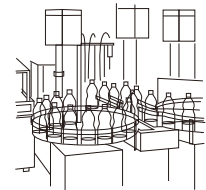

## Engineering environment MELSOFT

Q17nDSCPU

### MELSOFT MT Works2

[MELSOFT MT Developer2]

Motion SFC program, parameter setting, digital oscilloscope function, and simulation function are available. All process steps of Motion controller are done with this software, from system designing, programming, debugging, to maintenance.

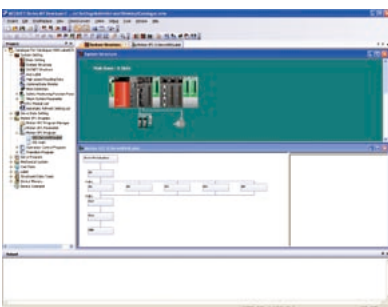

[MELSOFT MR Configurator2]

Parameter setting, adjustment and monitoring of servo amplifiers are available. MELSOFT MR Configurator2 is used with MELSOFT MT Works2.

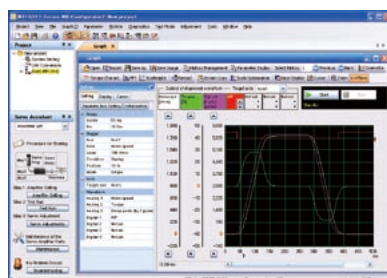

\* MELSOFT MR Configurator2 is included with MELSOFT MT Works2 as a standard.

### MELSOFT GX Works2

Sequence program, configuration tool of intelligent function module simulation function are available. All process steps of programmable controller are done with this software, from system designing, programming, debugging, to maintenance.

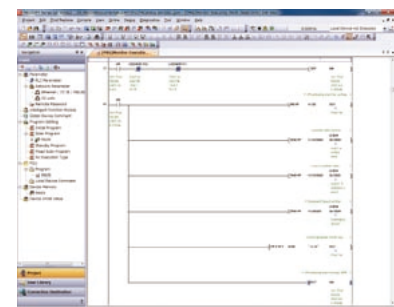





## High functionality for advanced Motion controls

Switch to various controls as you want

### Speed-torque control (Tightening & press-fit control) NEW

Continuous operation to torque control Patent pending

**Q17nDSCPU**

Torque control and tightening & press-fit control are also available in addition to position control and speed control. Switching the control mode from position control to torque control and back to position control as shown on the right is also possible with the Motion dedicated device. The torque control has two modes: "torque control" which starts after stopping once to ensure safety. "Tightening & press-fit control" which starts during movement. The current position is stored during both torque control and speed control, so positioning on the absolute position coordinates is possible even after switching to position control.

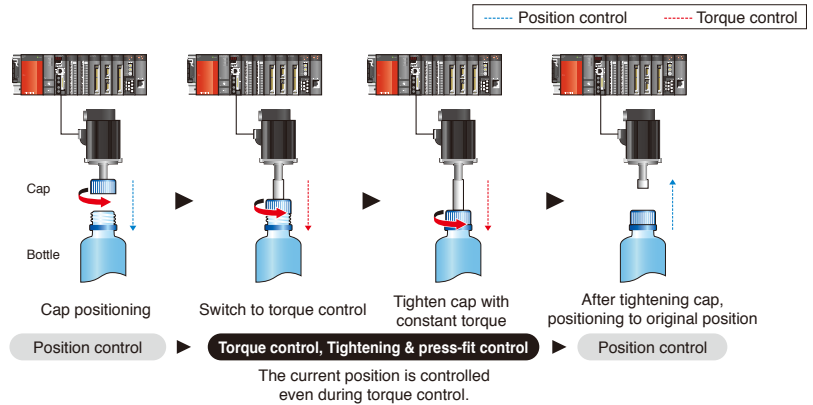

Register mark detection

### Mark detection function Q17nDSCPU

Register marks on the packing material are detected by sensor at high speed and set the current position to the device. The position of the register marks is compensated and the packing material is cut at the set position.

[Position compensation function during register mark detection]

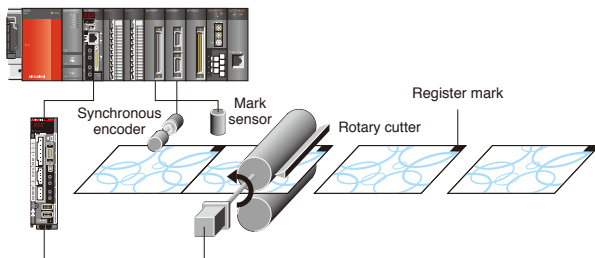

Smooth and faster acceleration

### Advanced S-curve acceleration/ deceleration Q17nDSCPU

The following interval rate are adjustable: the interval that acceleration rate changes smoothly (Sin wave interval), and the interval that the maximum acceleration rate is maintained (constant acceleration interval). The acceleration rate increases without losing the smoothness and high response.

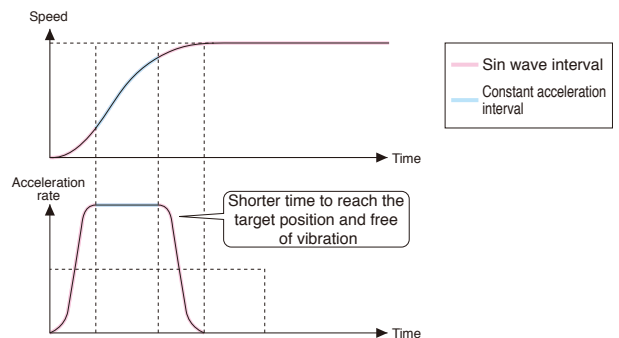

### Software security key function NEW

**Q17nDSCPU**

User data is protected by setting a software security key to the project and the operating system software "MELSOFT MT Works2". Access of the the personal computers and Motion CPU modules to the projects is limited.

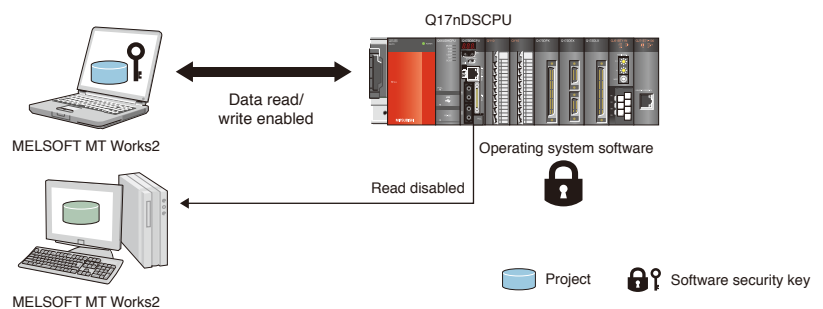

## Various Basic Functions

Q17nDSCPU

### Servo external input signals

Ver.UP

The servo external input signals (FLS, RLS, DOG) are now controlled via the bit device or general-purpose input signal in addition to via the servo external signals interface module (Q172DLX) and via the servo amplifier. The logic and validity of signals are set individually, so which make these signals more convenient to use.

### Internal Input signal (4-point)

NEW

Motion CPU has a internal input signal I/F (max. 4 points) You are allowed to use them as the general-purpose input signal and mark detection input signal.

### ROM operation function

Ver.UP

Systems is operated with the programs and parameters stored in the built-in FLASH ROM of the Motion CPU. If the system does not require an absolute position system or latch device, operation is carried out without a battery.

### Various home position return methods

12 home position return methods such as a retry function and shift function etc. are available to establish the home position used as the machine reference point. Select the home position return method according to the machine type.

### Target position change function

NEW

The target position is able to be changed during positioning. When calibrating the position with the vision sensor, etc., positioning to the final position is completed without starting positioning again.

### Optional data monitor function

Ver.UP

Various servo amplifier control data can be monitored by setting the data type or monitor data storage device to the MELSOFT MT Works2 system settings. For Motion controller with the MR-J4-B, up to six types of data, including power consumption and total power consumption, is able to be monitored.

### Servo parameter change function

NEW

Servo parameters are individually changed through the Motion SFC program etc., without connecting to MELSOFT MR Configurator2 in control operation.

### Phase compensation

In synchronous control with a synchronous encoder, the phase compensation function is used to compensate the delay time caused by a communication delay in the synchronous encoder data, etc.

### Operation control program

Ver.UP

In addition to the standard functions such as binary operation, bit operation, type conversion and trigonometric in the Motion SFC, the command for the scaling function that is suitable to calculate the coordinate conversions have been added. Conditional branching at an operation control step is also available.

### PERIPHERAL I/F (Ethernet)

The Motion CPU has a built-in PERIPHERAL I/F which is designed to be connected to various devices such as the graphic operation terminal, Cognex vision system with Ethernet etc.

### 4 million pulses synchronous encoder

NEW

4 million (22-bit) pulses synchronous encoder as standard greatly improves the synchronous operation accuracy. (16 times higher than conventional model.) High-accuracy control is achieved when used with MR-J4-B (standard 4 million (22-bit) pulses resolution).

### Limit switch output function

Within a set data range, a signal is able to be set to turn ON/OFF the watch data such as the real current value, motor rotation speed or motor current during operation

### Speed control with fixed position stop

The servo motor is set to rotate at the specified speed and, after the speed control with fixed position turns OFF, stopped at the specified position. Both the speed and the duration of acceleration/deceleration can be changed to any value during operation.

### Digital oscilloscope function

Ver.UP

With the digital oscilloscope of MELSOFT MT Works2, collection of data which is synchronized with the operation cycle and waveform display are available. Just follow the assistant function. Data of up to 16CH words or bits can be sampled, and of which 8CH words or bits can be displayed in real time.

### Torque limit value change

Ver.UP

The torque limit value during positioning or JOG operation is changed easily with the Motion dedicated instruction CHGT. By using the individual change request of torque limit value "CHGT2", the torque limit of driving direction and regeneration direction is possible to set individually.

### Servo amplifier control mode switching function

Ver.UP

Control mode switch command such as the gain switching function, PI-PID control and control loop (full closed, semi-closed) can be executed to the servo amplifier.

### Electronic cam control

Ver.UP

The electronic cam control is available with cam data created on MELSOFT MT Works2. Cam control for a degree axis or indirect designation of the number of pulses per cam axis rotation are possible now with new Motion CPU.



Event processing and programming environment have been improved drastically.

## Task operation examples of Motion SFC program (SV13/SV22)

**Q17nDSCPU**

The Motion control program is described in flowchart form using the Motion SFC (Sequential Function Chart) format.

- Motion SFC format program is suitable to the event process, controlling total machine operation.
- The entire system operation is easily programmed by using the icons such as **F** (Arithmetic Operation, I/O Control), **G** (Transition Conditional Judgement) and **K** (Motion Control) arranged in a sequential process.

### Motion SFC description

#### Flowchart description are easy to read and understand

- The machine operation procedure is visualized in the program by using the flowchart descriptions.
- A process control program can be created easily, and control details can be visualized.

#### A logical layered structure program

- Operation commands are easily described by creating comments.
- Operation commands are detailed in a step by step format in a layered structure program.

#### Controlling sequential machine operation using the Motion CPU

- Servo control, I/O control, and operation commands can be combined in the Motion SFC program.
- There is no need to create Sequence program for servo control.

#### Enhanced operation functions

- Commands is able to be described with arithmetic and logic operation expressions.
- Compatible with 64-bit floating-point operations.
- Arithmetic functions include trigonometric functions, square root, natural logarithm, etc.
- Describe the conditional branch (IF ELSE IEND), selective branch (SELECT CASE SEND) and repetition (FOR NEXT). **NEW**

#### Reduced display

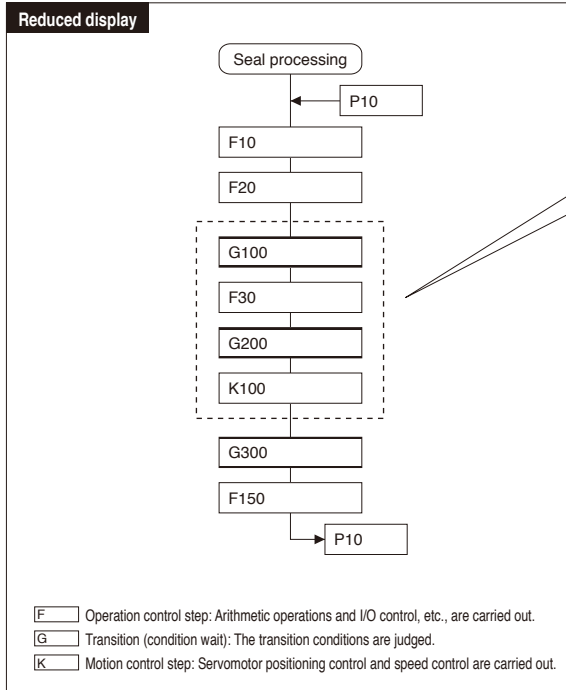

#### Comment display

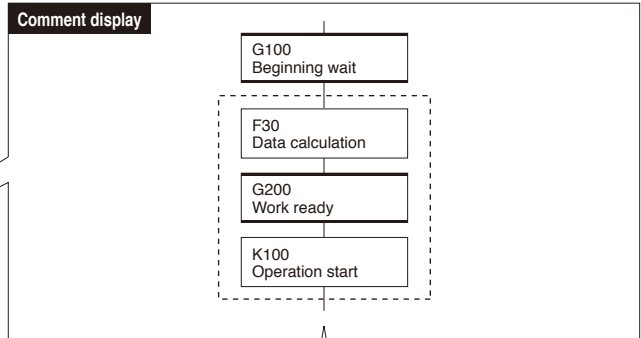

#### Extended display

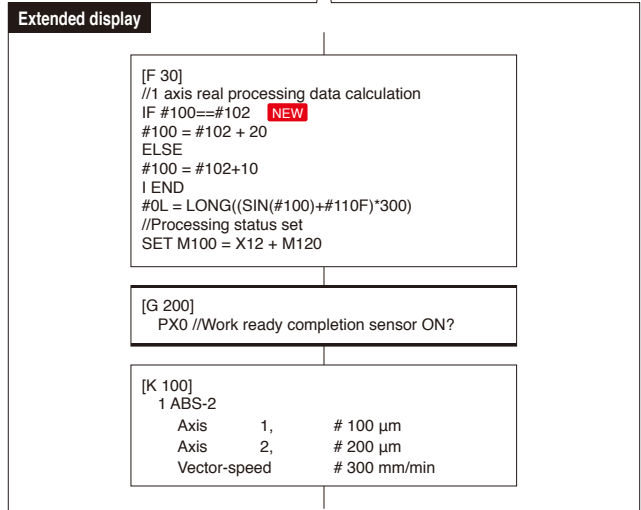



**Operating System software (Automatic machinery use SV22)** Q17mDSCPU

Incorporating a mechanical support language that allows easy programming of the mechanical system using a mouse while viewing the screen.

By combining a variety of software mechanical modules and cam patterns, complex synchronized control and coordinated control is achieved easily at low-cost. Ideal for controlling automatic machinery such as food processing and packaging.

**Control flow**

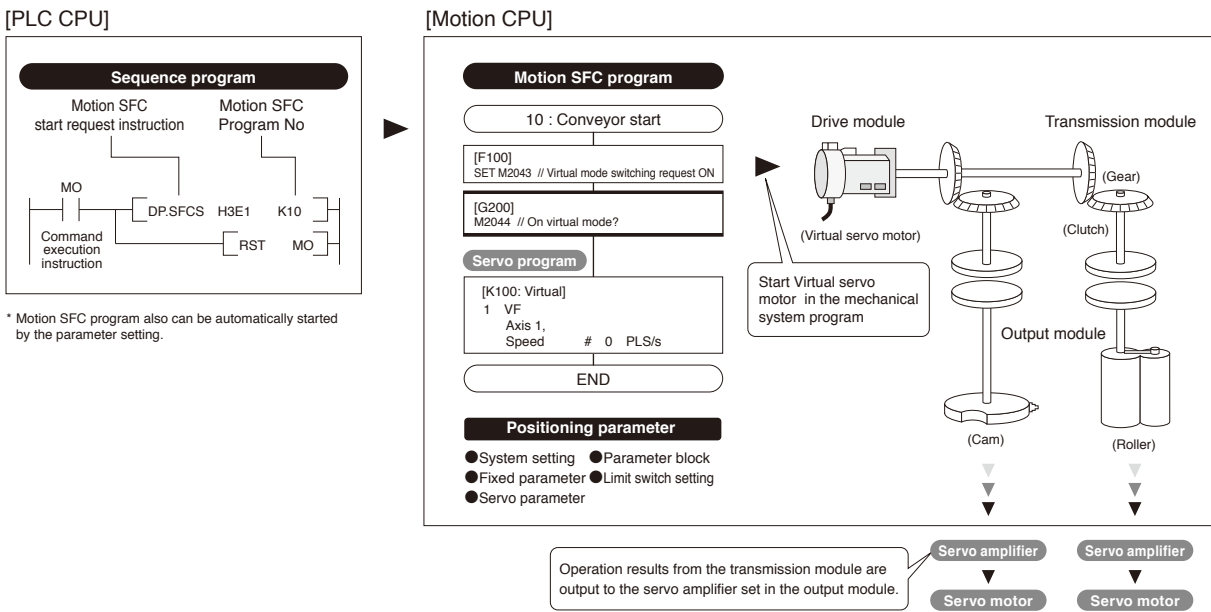

**Mechanical system program**

**Advanced synchronous control with simple settings**

Synchronous control is easily structured using a program, on which the mechanical modules such as a virtual main shaft, gears, clutches and cam are placed.

- Select and arrange mechanical modules on a computer.
- Easily understand the outline of the synchronous control just by looking at the mechanical system program.
- Monitor synchronous control on the mechanical system program.

**Advanced control with electronic cams**

Cam control is performed with software, so problems such as errors which occur with conventional cam control do not occur any more and ideal cam pattern control is achieved. Cam control for the up/down movement of a nozzle which contacts the fluid surface, the filling amount, and smooth transfer, etc. are easily executed. When the part type changes, you need to change only cam pattern.

[Easy programming with a mouse]

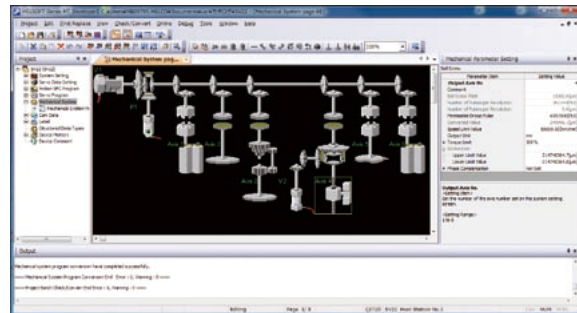

Programming screen using mechanical system program



## Leading the industry in safety

### Safety System NEW

**Q17nDSCPU**

The safety system complies with the harmonized standard for European machinery directive “EN ISO13849-1:2008 Category 3 PLd”. Safely-limited speed (SLS) and shut-off function is added as standard to safety signal comparison function, which confirms the status of the input/output signals that are compared mutually. The operating conditions for these safety functions freely programmed by the PLC CPU and Motion CPU ladder circuits. A safety system is also structured with safe stop (SS1, SS2, SOS), safe shut-off (STO, SBC) and safe speed monitor (SSM).

\*The safety specification applied to TÜV Rheinland for the certification is pending. Contact us for the details.

### Speed monitoring Function

The speed is monitored with the encoder pulses from the servo amplifier and the external auxiliary signals from the safety signal module.

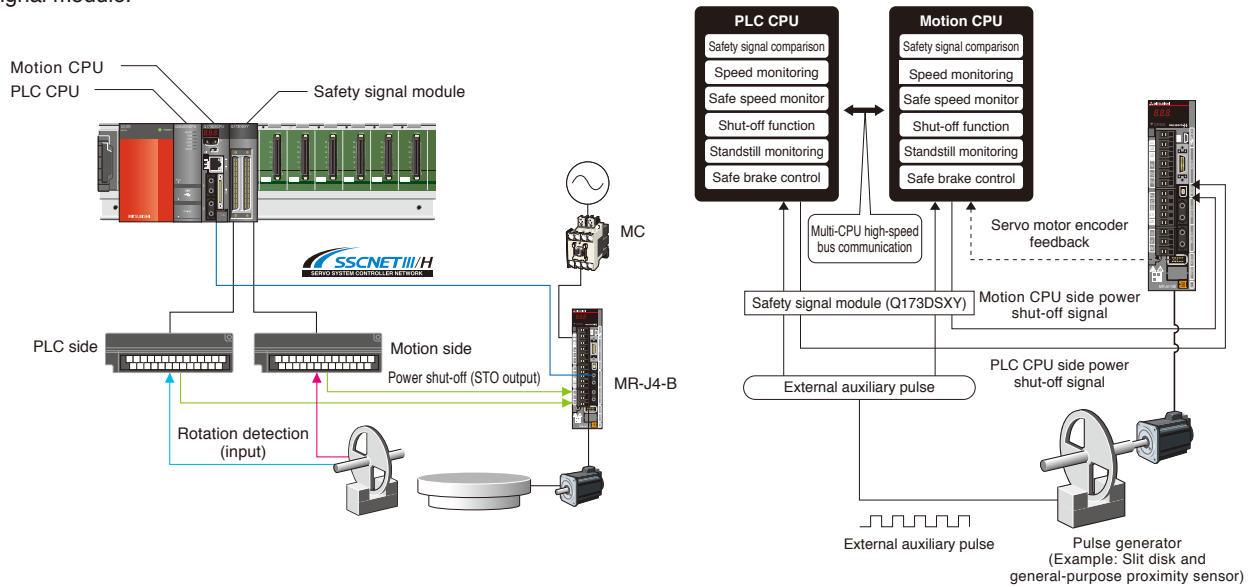

### Safety signal comparison function

The safety input signal is monitored using the Motion CPU, PLC CPU and safety signal module.

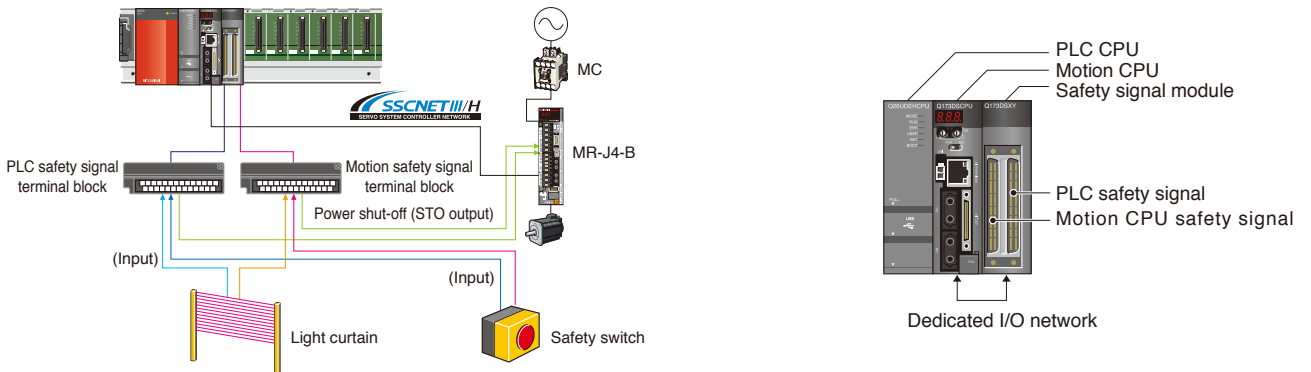

PLC CPU	QnUD(E)(H)CPU
Motion CPU	Q17nDSCPU
Safety signal module	Q173DSXY (up to 3 units can be installed)
Max. number of input points	60 points × 2 systems
Max. number of output points	36 points × 2 systems

	No. of points	Signal description
Input	20	User safety signals
Output	1	Power shut-off signal
	11	User safety signals

\*1: Power shut-off signal turns: ON when safety signal comparison function status is normal.OFF when error is detected.

\*2: All output signal points at the 2nd and 3rd modules can be used as user safety signals.

## ISO13849-1 Safety categories

“Safety categories” are indicators used to determine specific safety measures based on risk assessment results.

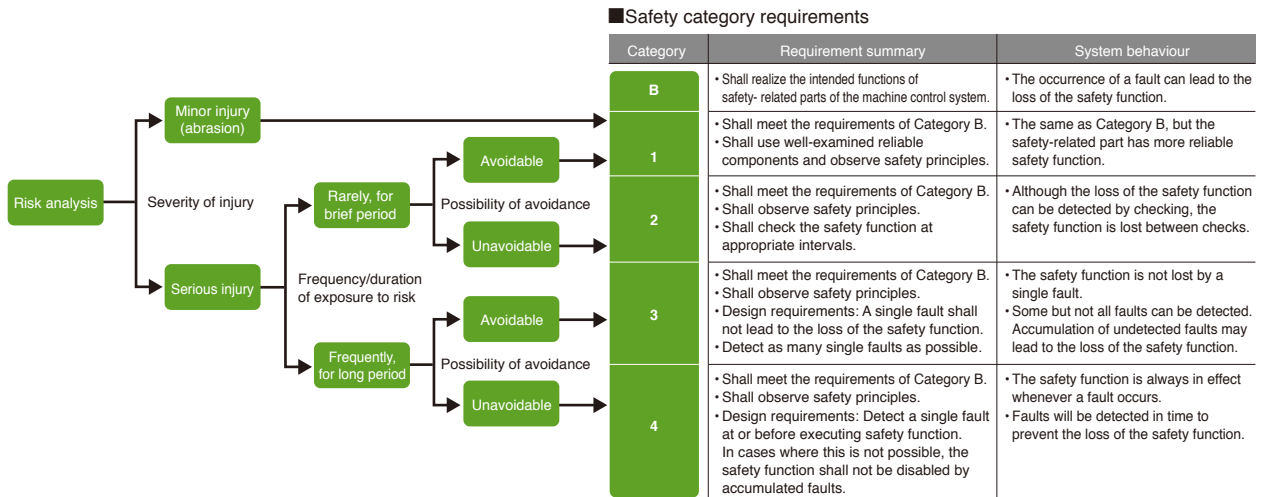

## ISO13849-1:2006 Performance level

Performance levels for safety-related parts of control systems have been revised in ISO13849-1:2006.

Based on the original safety categories, frequency of a dangerous failure occurrence (the safety function does not work when needed), rate of a failure detection by diagnostics, etc. were added to evaluate comprehensively. The evaluation result is classified into five levels from “a” to “e” by the performance level (PL).

● Like the safety categories, the risk is evaluated from a perspective of “S: Severity of injury,” “F: Frequency or duration of exposure to risk,” and “P: Possibility of avoidance.”

■ Risk graph in ISO13849-1:2006 and PLr for safety function

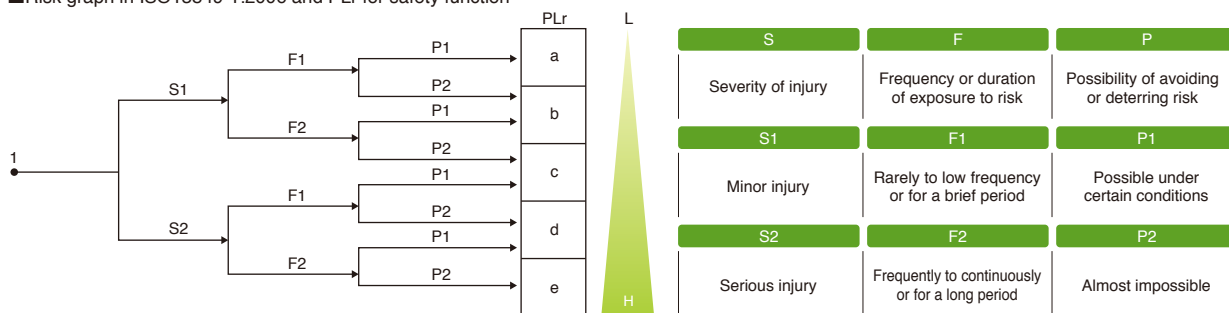

## Safety Category IEC/EN 61800-5-2

These functions are defined as “power drive system electric safety function” in IEC/EN61800-5-2. The functions supported by the Motion controller are listed on the right.

Item (IEC/EN 61800-5-2:2007)	Description
STO	Safe torque off
SS1	Safe stop 1
SS2	Safe stop 2
SOS	Safe operating stop
SLS	Safely-limited speed
SBC	Safe break control
SSM	Safe speed monitor





# A robust and easy-to-use programming environment for advanced Motion control

Motion controller programming software **MELSOFT MT Works2**

## Programming

**Q17nDSCPU**

### User-friendly functions for program development

- Graphical Motion SFC program, mechanical system program
- Label, device comment, cross reference
- Programming with axis label (name) **NEW**
- Instruction wizard and instruction help eliminate need to refer to manuals.

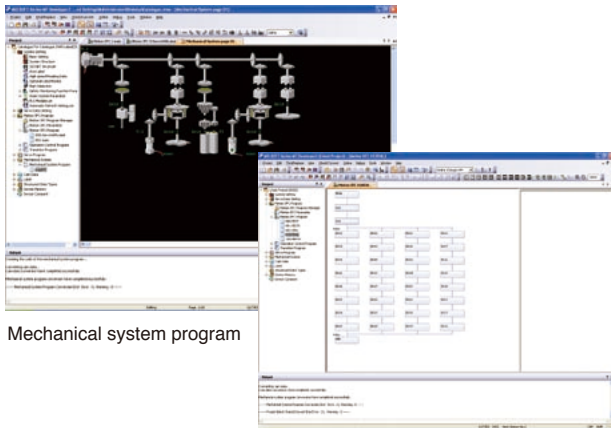

Mechanical system program

Motion SFC program

### Easily divert the existing program **NEW**

- Easily divert the existing SFC program from the original project to the new project just by using drag&drop.
- Add program comments to project tree for easy identification of programs.

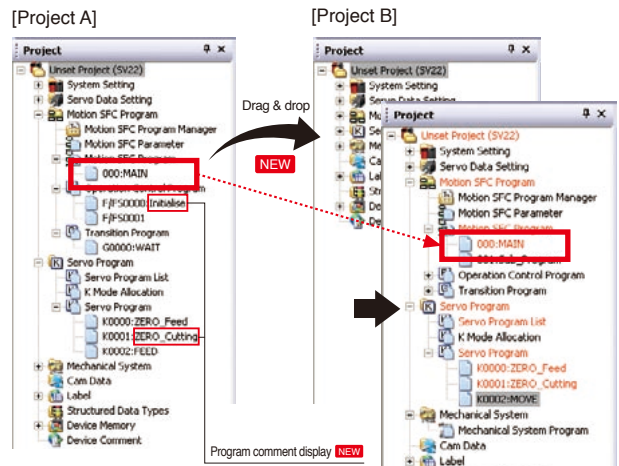

## System design

**Q17nDSCPU**

- Easily set servo amplifiers and modules with graphical system setting screen.
- Use the one-point help to set parameters without a manual.
- Easily set the complicated electronic gear just by inputting the machine specifications (reduction ratio, ball screw pitch, etc.). **NEW**

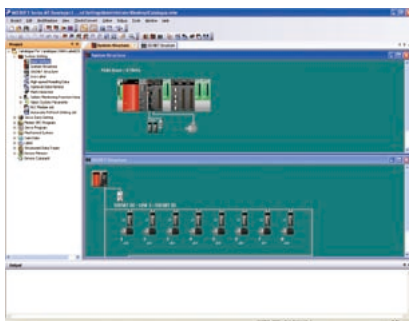

System Structure

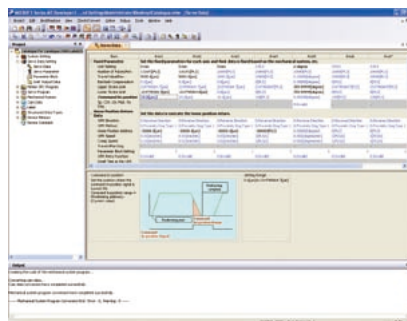

Servo Data

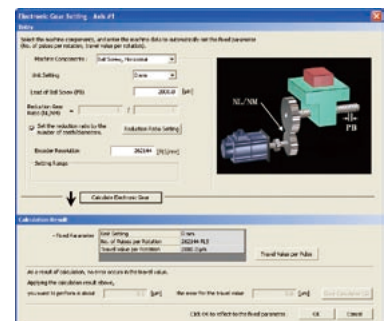

Electric Gear Setting

## Setup and adjustment

Q17nDSCPU

Calibration and testing tools for quick, easy, process setup

### Monitor function

Easily confirm the Motion controller operation status with the various monitoring functions.

- Motion SFC program monitor
- Mechanical program monitor
- Current value monitor, positioning monitor, scroll monitor, error history monitor



Monitor

### Digital oscilloscope function

Operation check and troubleshooting are powerfully supported with data collection and wave displays which are synchronized to the Motion operation cycle.

- The assistant function explains all work steps.
- Set often-viewed data easily with the purpose-based probe setting.
- Sample 16CH word and 16CH bit data. Of this, 8CH words and 8CH bits can be displayed in real time. **NEW**

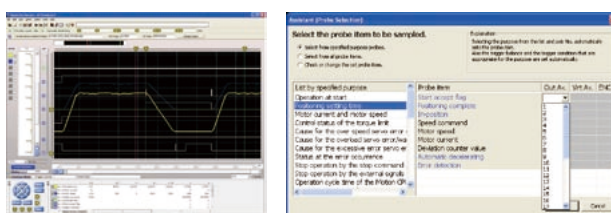

Digital oscilloscope

### Various test operation functions

- Basic startup is able to be confirmed without a program in the test mode.
- Use the simulator function to debug the Motion SFC program and mechanical system programs without an actual machine.
- Step execution and brake point setting are possible with the Motion SFC program debug function.

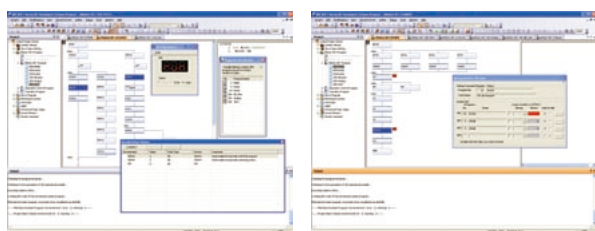

Simulator

Test

### Collaboration with MELSOFT MR Configurator2

- Adjust servo parameters with MELSOFT MR Configurator2, the software created with Mitsubishi servo know-how.
- Adjust multiple axes with a personal computer connected to the controller.
- MELSOFT MR Configurator2 is included in MELSOFT MT Works2. **NEW**

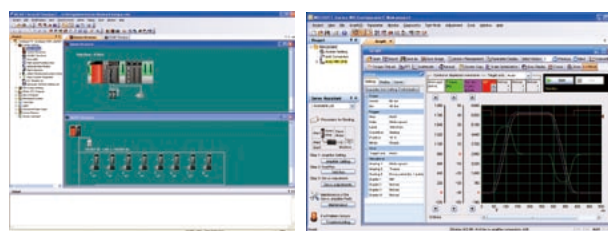

Graph

## A variety of security options

Q17nDSCPU

### Controlling access to project data

- Specify the users who access to the project to ensure the security.
- Prevent inadvertent editing of the created project data by setting access limits to each registered user.

### Protecting Motion SFC programs **NEW**

- Motion SFC program is password-protected and is set to show/hide individually, thereby which prevent program data in a project from being stolen.

### Controlling access to Motion CPU **NEW**

- A software security key set to the Motion CPU and personal computer prevents the Motion CPU from illegal access.

Advanced but simple as a positioning module

SSCNET III/H compatible Simple Motion

## System Configuration

QD77MS

Maximum number of axes controlled by a module: up to 16 axes (QD77MS4), up to 4 axes (QD77MS2), up to 2 axes (QD77MS16).  
 QD75MH project is diverted to QD77MS one.

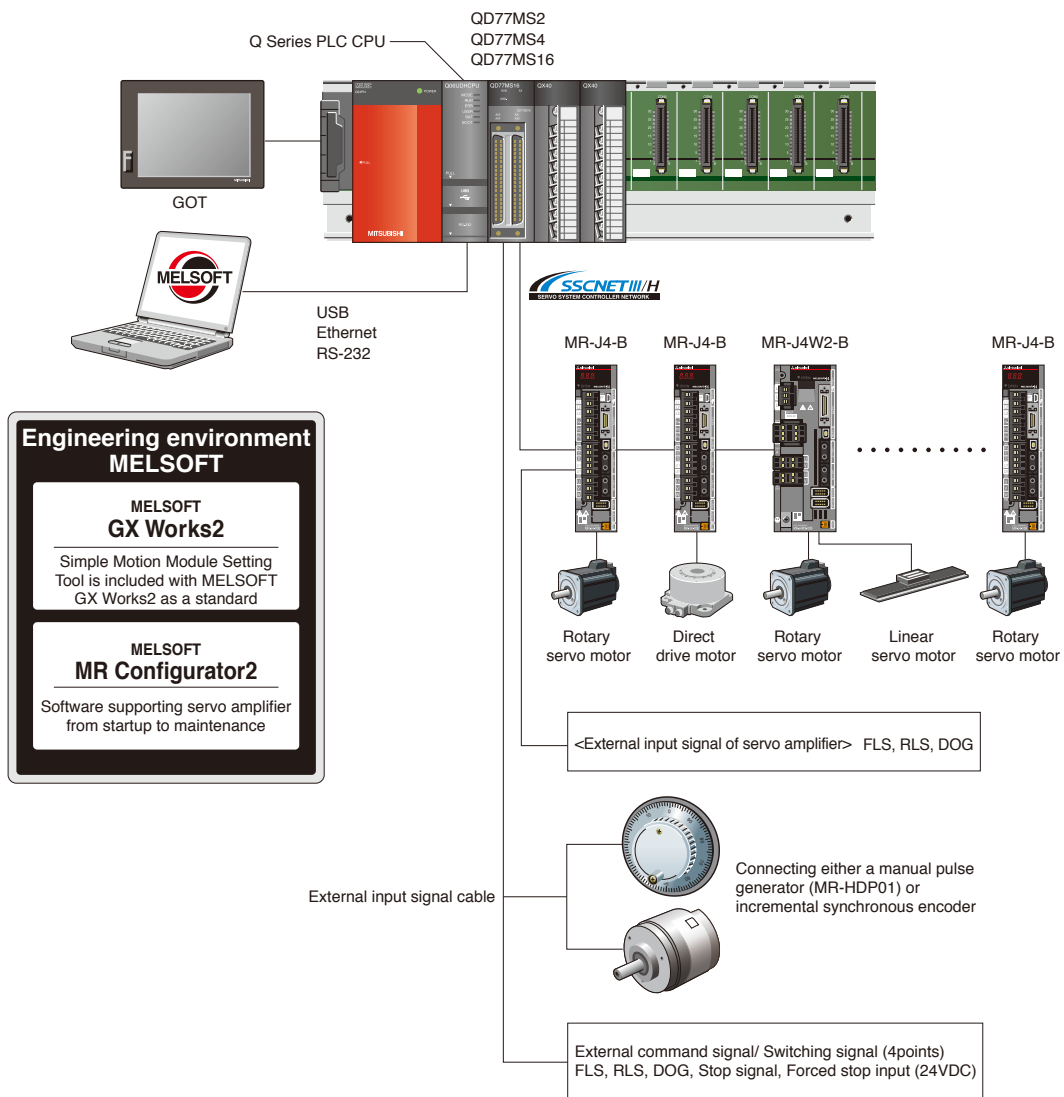

# QD77MS16/QD77MS4/QD77MS2



## Control flow

QD77MS

Simple Motion positioning starts from the PLC CPU.

Simple Motion starts operation from the designated positioning data No., and executes continuous operation until the operation pattern ends.

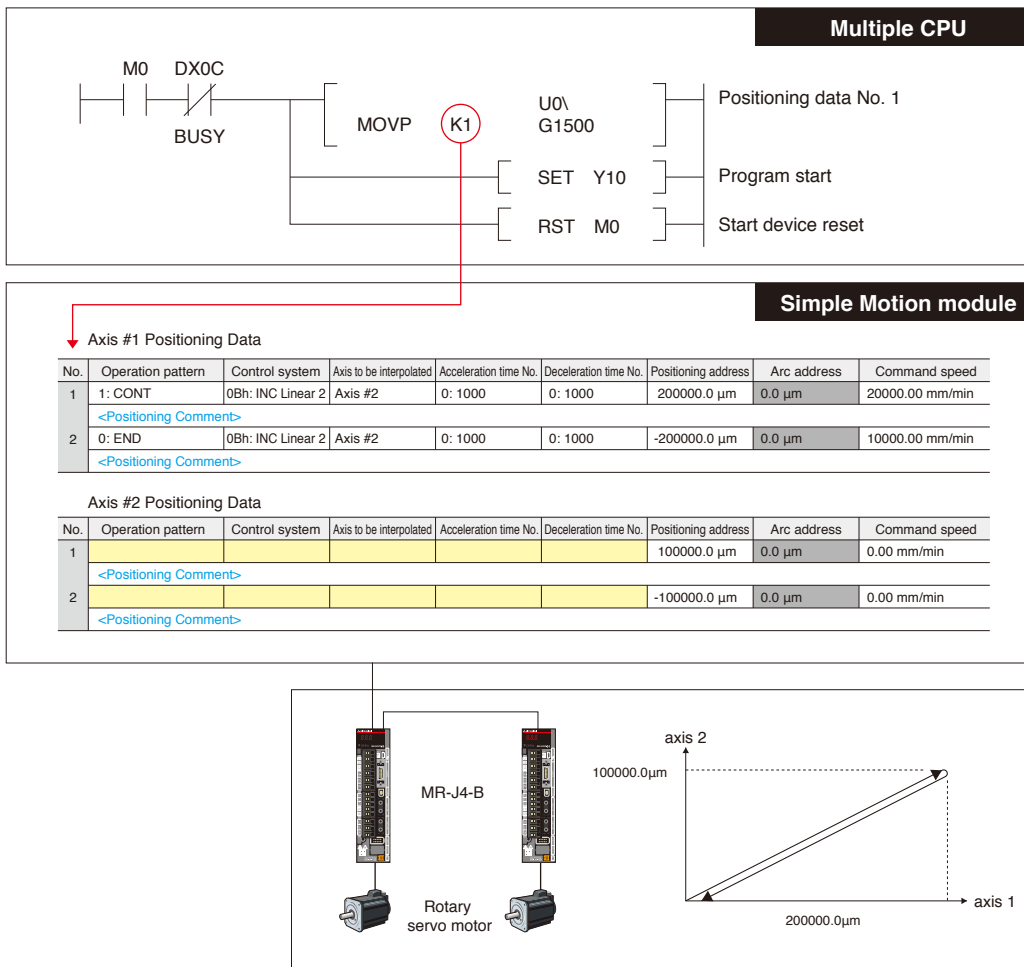

## High compatibility with the conventional models

QD77MS

The positioning module (QD75MH) projects and sequence programs is easily diverted to the Simple Motion module (QD77MS) projects.

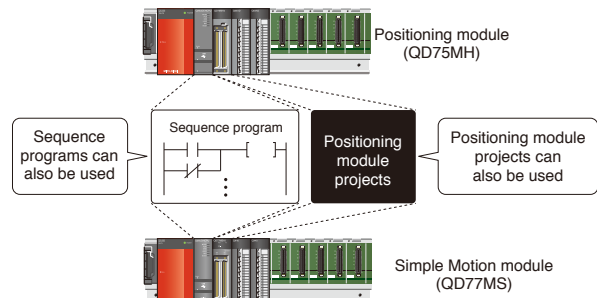





## Simple operation and high functionality with our cutting-edge technology

### Positioning control

QD77MS

- Apply to various machines with extensive control such as linear interpolation control, 2-axis circular interpolation control, fixed feed control and continuous trajectory control.
- Easily execute automatic operation by setting the positioning addresses and speeds, etc., to a sequence program.
- Powerful sub-functions such as M codes, skip function, step operation and target position change function.

#### Sealing

- Continuous orbit control
- Linear/circular interpolation
- Synchronous control
- High-speed, high-accuracy orbit calculation

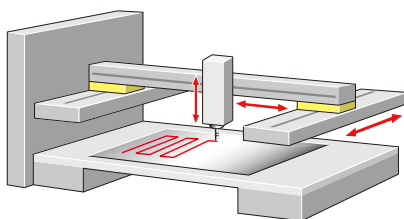

#### X-Y table

- 2-axis linear interpolation
- 2-axis circular interpolation
- 3-axis linear interpolation
- Continuous orbit control

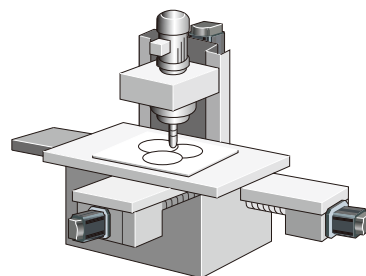

### Synchronous/Cam control NEW

QD77MS

The work piece handled from line 1 is transferred to the relay point by robot 1. After robot 1 returns to its original position, the work piece at the relay point is moved to line 2 by robot 2. Robot 1 and robot 2 need to check each other's position when handling them, so which make tact time longer. In cam control, the robot positions are determined by the cam pattern, so the robots can efficiently handle the work pieces.

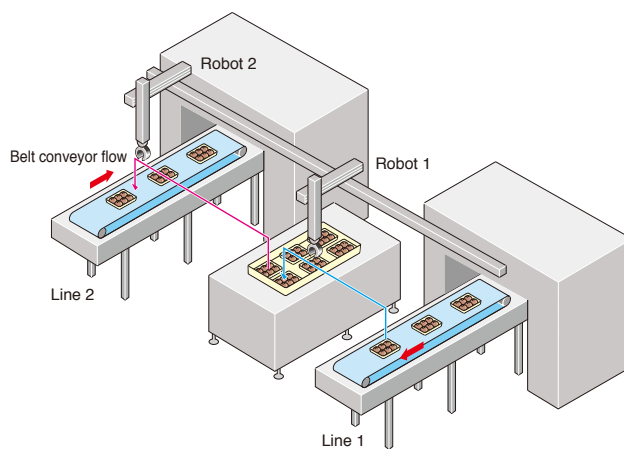
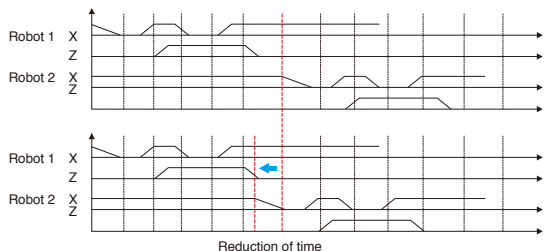

### Speed-torque control (Tightening & Press-fit control) NEW

Tightening & Press-fit control Patent pending

QD77MS

Tension control such as rewinding and winding axes are available. As the absolute position is stored even during the Speed-torque control, the positioning on coordinates is possible after switching from the Speed-torque control to position control.

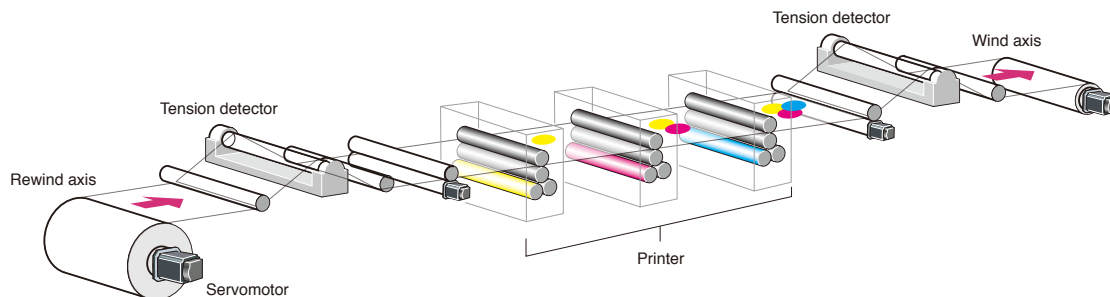

Simple cam profile creation

## Cam auto-generation function NEW

QD77MS

The cam data for the rotary cutter is created easily just by entering the sheet length, synchronization width and cam resolution, etc., in the sequence program.

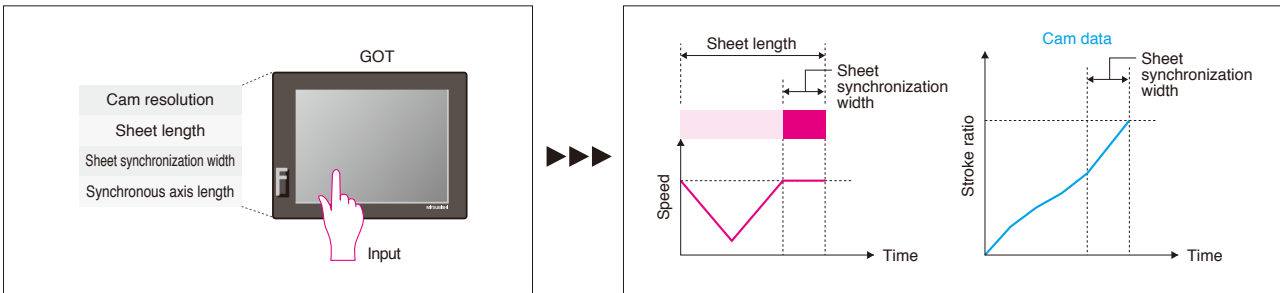

Various servo data is in your hand

## Optional data monitor function NEW

QD77MS

The servo amplifier and servo motor information is monitored via the Simple Motion module. The information is also possible to be displayed on a user-created screen.

### Designatable data

Effective Load Ratio, Regenerative Load Ratio, Peak Torque Ratio, Load Inertia Ratio, Position Loop Gain 1, Main Circuit Bus Voltage, Position feed back, ABS ENC single Rev. Pos, Power Consumption, Total power consumption, etc.

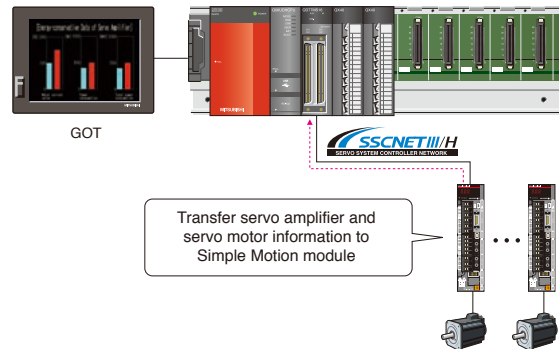

Flexible to change the target position

## Target position change function

QD77MS

The target position is able to be changed at any timing even when works are moving (1-axis linear control). In the machine process shown on the right, the product is being inspected while moving to the next line. If a reject is found, the target position is changed so that the project is put in the reject bucket.

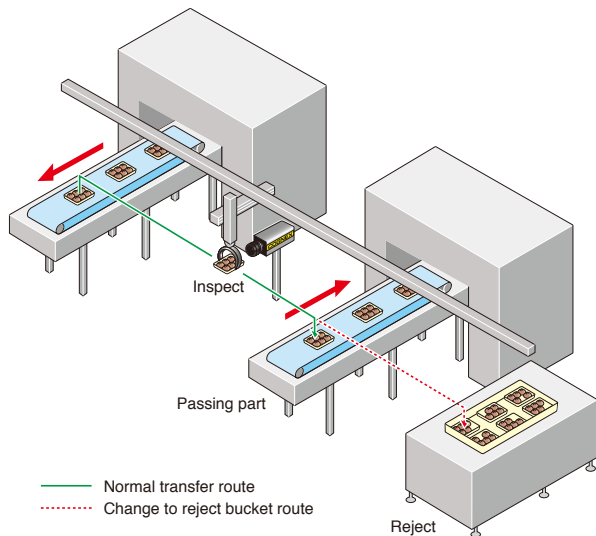



## Positioning data

QD77MS

Execute positioning control with the data table method.

- The Data Setting Assistant function simplifies settings.
- Positioning data can be set very simply by using functions such as Automatic Command Speed Calculation, Offline Simulation, and automatic calculation of auxiliary arc, etc.

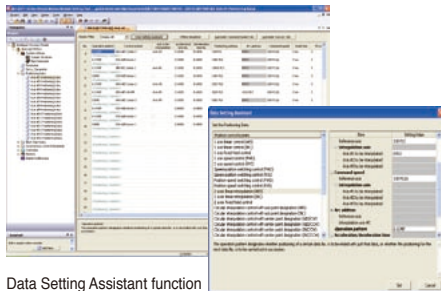

Data Setting Assistant function



Automatic Command Speed Calculation

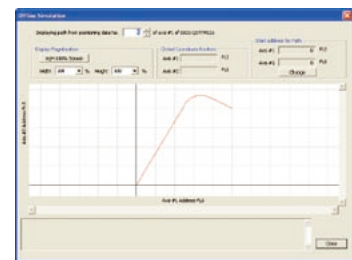

Offline Simulation

## Synchronous control data

QD77MS

Synchronous control data is easily created with software by placing mechanical modules on screen, such as the gear, shaft, speed change gear and cam.

- Easily perform the Synchronous control with parameter settings. There is no need to create complicated programs.
- Start and stop synchronous control for each axis.  
Use the synchronous control axis and positioning control axis together.
- Transmit the travel value of main shaft to the output axis via the clutch.

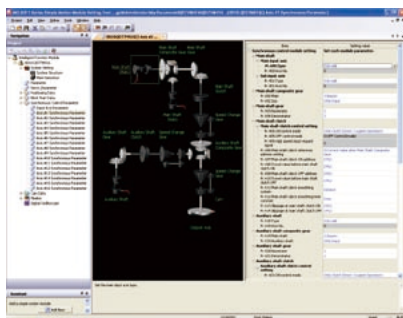

Synchronous Control Parameter Settings

## Cam control data

QD77MS

Easily create cam data for various patterns.

- Cam control becomes more flexible than the conventional ones. Various cam pattern is available.
- Set the stroke, speed, acceleration and throb while simultaneously checking the profile on a graph.
- Easily check the created cam data by viewing as thumbnail displays of cam data.
- Import and export cam data in CSV format.

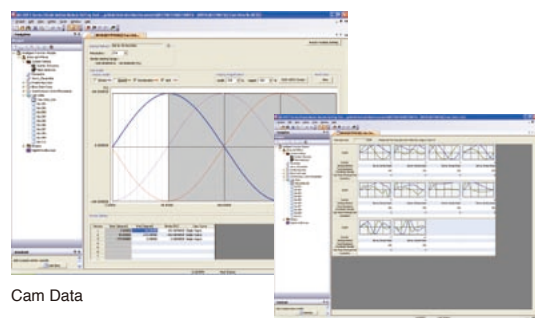

Cam Data

Cam Data List

## Parameter settings

QD77MS

- One-point help allows parameters to be set without needing a manual.
- Easily set the applicable servo amplifier on a graphical screen.
- Just specify the mechanism configuration (reduction ratio, ball screw pitch, etc.). There is no need to set complicated electric gear setting.

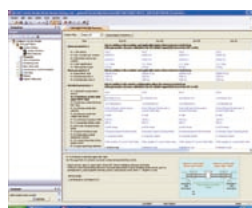

Parameter Settings

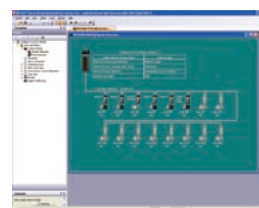

System Structure Setting



Electronic Gear Settings

## Installation

QD77MS

### Digital oscilloscope function

- Operation confirmation and troubleshooting are powerfully supported with data collection and wave displays which are synchronized to the Motion operation cycle.
- The assistant function explains all work steps.
- Set often-viewed data easily with the purpose-based probe setting.
- Sample 16CH word and 16CH bit data. Of this, 8CH words and 8CH bits can be displayed in real time.



Digital Oscilloscope

### Monitor and test functions

- Easily complete system installation and operation checks with powerful monitor and test functions.
- Select items to be displayed on the monitor from the voluminous information monitor options.
- Use the test function to check basic operations without a sequence program.



Axis Monitor

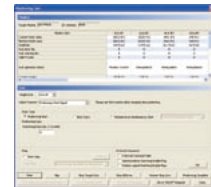

Positioning Test

## Adjustment of servo amplifier parameters

QD77MS

Collaboration with the MR Configurator2 increases the servo installation efficiency.

Set and adjust servo amplifier parameters with the MR Configurator2, the software created with Mitsubishi servo know-how.

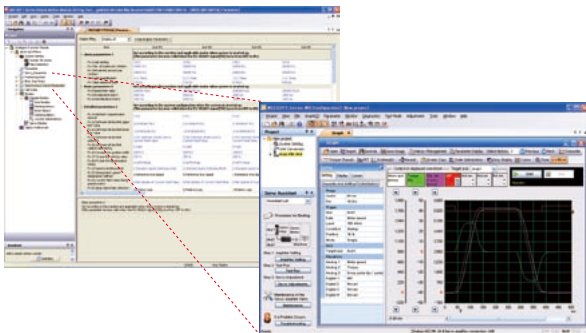

Graph

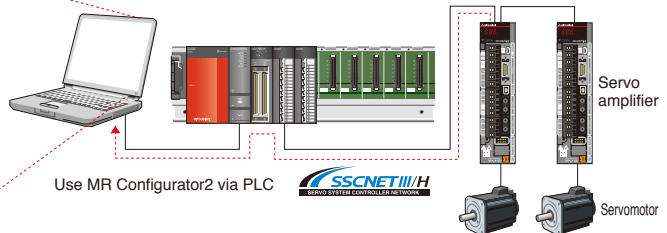



# Servos in harmony with man, machine and the environment



## SERVO AMPLIFIER

Compatible with the advanced high-speed motion network "SSCNET III/H", these servo amplifiers operate rotary/linear servo motors or direct drive motors as standard. Multi-axis servo amplifiers are also available, achieving energy conservation, space-saving, and reduced wiring.



SSCNET III/H compatible  
servo amplifier  
**MR-J4-B**



SSCNET III/H compatible  
2-axis servo amplifier  
**MR-J4W2-B**



SSCNET III/H compatible  
3-axis servo amplifier  
**MR-J4W3-B**

## SERVO MOTOR

Rotary servo motors for high-torque output during high speed. Linear servo motors for highly accurate tandem synchronous control. Direct drive motors for compact and rigid machine, and high-torque operations. A variety of models is available to match various applications.

### Rotary servo motor



Small capacity,  
low inertia  
**HG-KR**  
series  
Capacity: 50 to 750 W



Small capacity,  
ultra-low inertia  
**HG-MR**  
series  
Capacity: 50 to 750 W



Medium capacity,  
medium inertia  
**HG-SR**  
series  
Capacity: 0.5 to 7 kW

### Linear servo motor



Core type  
**LM-H3** series  
Rating: 70 to 960 N



Core type  
(natural/liquid cooling)  
**LM-F** series  
Rating: 300 to 1200 N  
(natural cooling)  
Rating: 600 to 2400 N  
(liquid cooling)



Core type with magnetic  
attraction counter-force  
**LM-K2** series  
Rating: 120 to 2400 N



Coreless type  
**LM-U2** series  
Rating: 50 to 800 N

### Direct drive motor



**TM-RFM** series  
Rating: 2 to 240 N·m

# Machine

## Industry-leading level of servo amplifier basic performance

Industry-leading levels

Our original, ever-evolving high-speed servo control architecture is applied to the dedicated execution engine. **Speed frequency response is increased to 2.5 kHz, achieving the industry leading level of speed\***. Compatible servo motors are equipped with a **high-resolution absolute encoder of 4,194,304 pulses/rev (22-bit)**, improving the processing speed substantially.

The performance of the high-end machine is utilized to the fullest.

[Settling time comparison with the prior model]

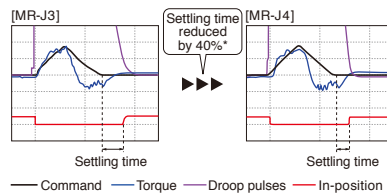

\* The result is based on our evaluation condition.

[Dedicated execution engine]

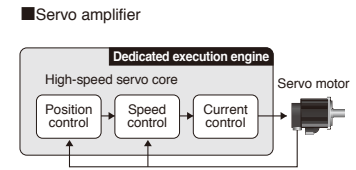

\* Based on Mitsubishi Electric research as of January 2012.

## Improving machine performance with high-performance motors

Industry-leading levels

Rotary servo motors achieve high-accuracy positioning and smooth rotation with a high-resolution encoder and improved processing speed.

[Resolution comparison with the prior model]



## Advanced one-touch tuning function

Enhanced functions

Servo gains including machine resonance suppression filter, advanced vibration suppression control II, and robust filter are adjusted just by turning on the one-touch tuning function. Machine performance is utilized to the fullest using the advanced vibration suppression control function.

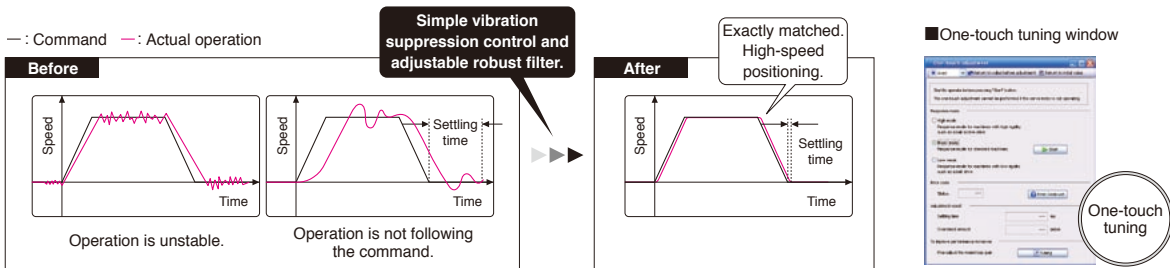

## Advanced vibration suppression control II

Patent pending Enhanced functions

Due to vibration suppression algorithm which supports three-inertia system, two types of low frequency vibrations are suppressed at the same time. Adjustment is performed with one-touch operation. This function is effective in suppressing vibration at the end of an arm and in reducing residual vibration in a machine.

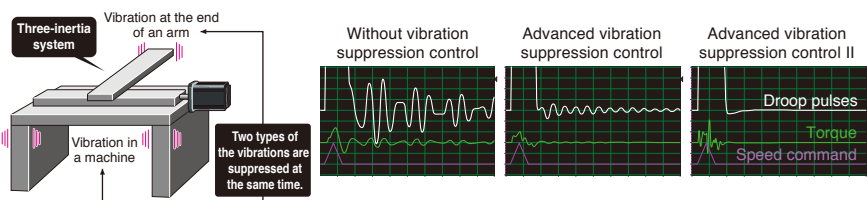

## Compatible with safety function IEC/EN 61800-5-2 as standard<sup>2</sup>

MELSERVO-J4 series servo amplifiers have integrated STO (Safe Torque Off) and SS1<sup>1</sup> (Safe Stop 1) functions<sup>2</sup>.

Safety system is easily configured in the machine. (SIL 2)

- Turning off the control power of servo amplifier is not required, cutting out the time for restart. Additionally, home position return is not required.
- The number of magnetic contactor for preventing unexpected motor start is reduced.

<sup>1</sup>: Safety equipment (MR-J3-D05, etc.) or Motion controller safety signal module (Q173DSXY) is required.  
<sup>2</sup>: Under application. Contact your local sales office for more details.

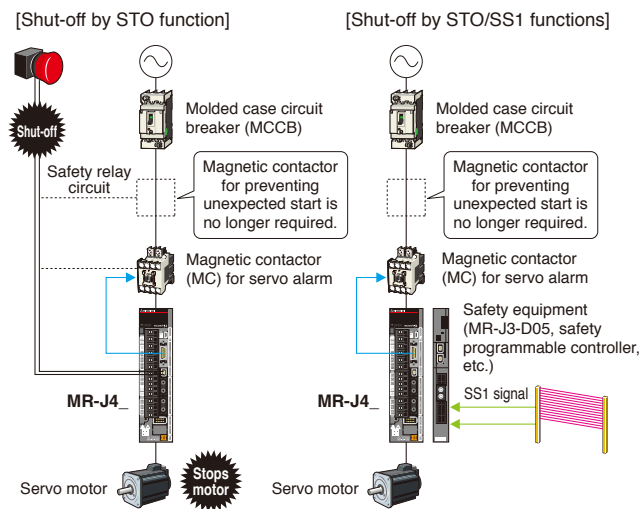

## Large capacity drive recorder

Patent pending Enhanced functions

- Servo data such as motor current and position command before and after the alarm occurrence are stored in non-volatile memory of servo amplifier. The data read on MR Configurator2 during restoration are used for cause analysis.
- Check the waveform of 16 alarms in the alarm history ((analog 16 bits × 7 channels + digital 8 channels) × 256 points) and the monitor value.

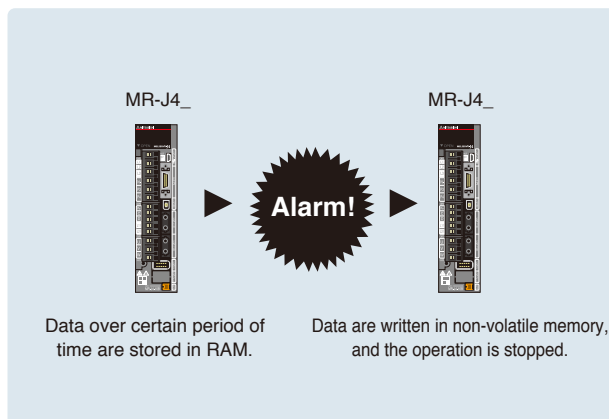

## Tough drive function

Enhanced functions

Detect changes in the operating environment to automatically adjust the servo control status.

### Vibration tough drive

Machine resonance suppression filter is readjusted when vibration is detected by the current command inside the servo amplifier.

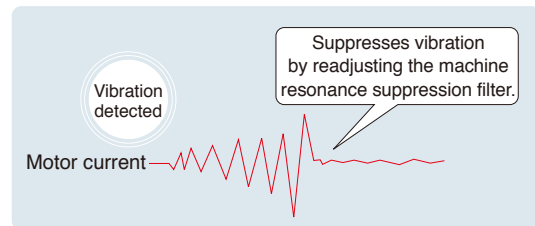

### Instantaneous power failure tough drive

Undervoltage alarm is prevented by changing detection time when instantaneous power failure in main circuit power is detected.

## Machine diagnosis function

Patent pending NEW

This function detects faulty machine parts (ball screw, guide, bearing, belt, etc.) by analyzing machine friction, load moment of inertia, unbalanced torque, and changes in vibration component from the data inside the servo amplifier, supporting timely maintenance of the driving parts.

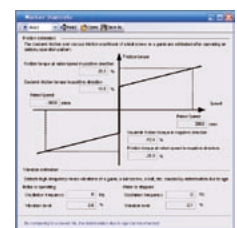

Machine diagnosis window

Servo setup software

## MELSOFT MR Configurator2

Tuning, monitor display, diagnosis, reading/writing parameters, and test operations are easily performed on a personal computer. This start-up support tool achieves a stable machine system, optimum control, and short setup time.

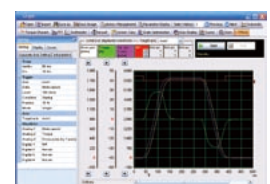

Graph window

# The Environment

## 2-axis/3-axis types for energy-conservative, miniaturized, and low-cost machine

### Space-saving with industry's smallest\* 3-axis type

2-axis servo amplifier MR-J4W2-B requires 26% less installation space than two units of MR-J4-B. 3-axis servo amplifier MR-J4W3-B requires 30% less installation space than three units of MR-J4-B.

[Installation space]

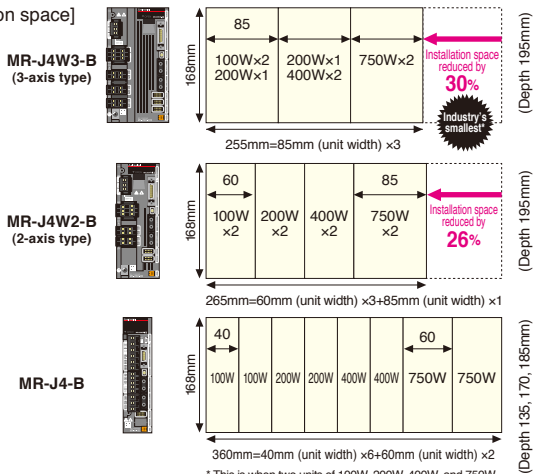

### Reduced wiring by approx. 50% with 3-axis type

In 3-axis servo amplifier MR-J4W3-B, the three axes use the same connections for main and control circuit power, peripheral equipment, control signal wire, etc. Thus, wiring is greatly reduced.

[Comparison of wiring]

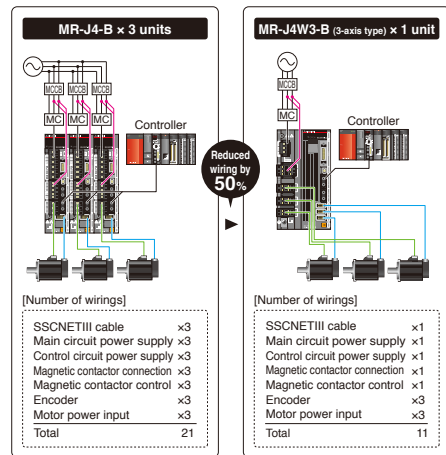

## Supporting energy-conservative machine using regenerative energy

The regenerative energy of an axis is used as driving power for the other axes, contributing to energy-conservation of machine. Reusable regenerative energy stored in the capacitor is increased in MR-J4W\_ as compared to the prior model. Regenerative option is no longer required.

\* Regenerative resistor may be required depending on the conditions.

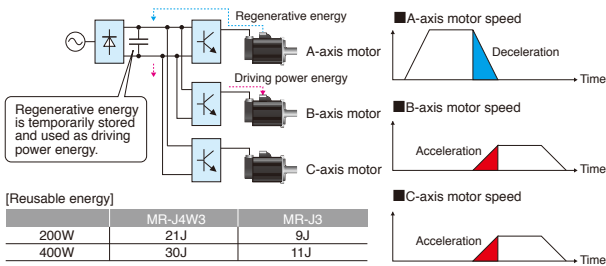

## Energy-conservation achieved by LM-H3 linear servo motor series

NEW

### Reduced motor driving power

LM-H3 series achieves reduction of motor driving power due to optimized magnet form and new magnetic design by 25%\*. Conservation of power is achieved for machine. As compared to the prior model, the motor coil is lighter by approximately 12%\*. The energy required to drive the moving part is reduced.

\* For 720 N rated linear servo motor.

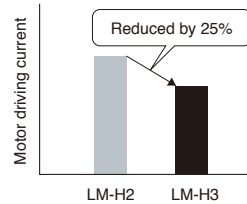

## Heritage

- MR-J4-B/A has the same mounting dimensions\* with MR-J3-B/A. HG rotary servo motor series has the same mounting dimensions and uses the same cables for the power, the encoder, and the electromagnetic brake as HF series.

\* Mounting dimensions are smaller for 5kW servo motor.

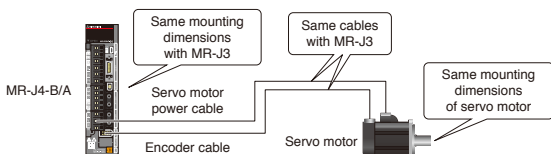

- SSCNET III/H /SSCNET III compatible products can be used together.

\* When using SSCNET III/H compatible and SSCNET III compatible products together, the communication speed is 50 Mbps, and the function and performance are equivalent to when using MR-J3.

- Parameters of MR-J3-B are converted to those of MR-J4-B, using the parameter converter function of MELSOFT MT Works2. (Available in 2012)

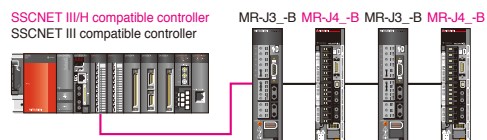





## Motion controller specifications

### Control specifications

Item	Specifications	
	Q173DSCPU	Q172DSCPU
Number of control axes	32 axes (Up to 16 axes/ system)	16 axes <b>NEW</b>
Operation cycle (Operation cycle setting)	0.2ms, 0.4ms, 0.8ms, 1.7ms, 3.5ms, 7.1ms	
Interpolation function	Linear interpolation (Up to 4 axes), Circular interpolation (2 axes), Helical interpolation (3 axes)	
Control modes	PTP (Point to Point) control, Speed control, Speed-position switching control, Fixed-pitch feed, Constant speed control, Position follow-up control, Speed control with fixed position stop, Speed switching control, High-speed oscillation control, Synchronous control (SV22)	
Acceleration/deceleration control	Trapezoidal acceleration/deceleration, S-curve acceleration/deceleration, Advanced S-curve acceleration/deceleration	
Compensation function	Backlash compensation, Electronic gear, Phase compensation (SV22)	
Programming language	Motion SFC, Dedicated instruction, Mechanical support language (SV22)	
Program capacity (Dedicated instruction)	16k steps	
Number of positioning points	3200 points (Positioning data can be set indirectly)	
Peripheral interface	PERIPHERAL I/F, Via PLC CPU (USB, RS-232, Ethernet)	
Home position return function	Proximity dog type (2 types), Count type (3 types), Data set type (2 types), Dog cradle type, Stopper type (2 types), Limit switch combined type, Scale home position signal detection type (Home position return re-try function provided, home position shift function provided)	
JOG operation function	Provided	
Manual pulse generator operation function	Possible to connect 3 modules (Q173DPX use) Possible to connect 1 module (Internal I/F use) <sup>(Note-5)</sup>	<b>NEW</b>
Speed-torque control	Speed control without positioning loops, Torque control, Tightening & Press-fit control	<b>NEW</b>
Synchronous encoder operation function	Possible to connect 12 modules (SV22 use)	
M-code output function	M-code output function provided, M-code completion wait function provided	
Limit switch output function	Number of output points 32 points, Watch data: Motion control data, Word device	
ROM operation function	Provided	
External input signal	Q172DLX (FLS, RLS, STOP, DOG) , External input signals (FLS, RLS, DOG) of servo amplifier or Bit device	<b>Ver.UP</b>
High-speed reading function	8 points (Via Input module, Via tracking of Q172DEX/Q173DPX), 4 points (Via Q17nDSCPU's Internal I/F)	
Mark detection function	Mark detection signal	Continuous Detection mode, Specified Number of Detections mode, Ring Buffer mode <b>NEW</b> 4 points (Via Q17nDSCPU's Internal I/F), <b>NEW</b> Bit device, Q172DLX (DOG)
	Mark detection setting	32
Torque limit value change function	Forward new torque value, Reverse new torque value	<b>Ver.UP</b>
Target position change function	Provided	<b>NEW</b>
Servo parameter change function	Provided	<b>NEW</b>
Servo amplifier control mode switching function	Gain switching function, PI-PID control, Control loop changing (semi closed loop control, fully closed loop control)	<b>Ver.UP</b>
Optional data monitor function	6 setting/axes (MR-J4-B's SSCNET III/H use)	
Forced stop function	Motion controller forced stop (EMI terminal, System setting), Forced stop terminal of servo amplifier	
Number of input/output points	Total 256 points (Q17nDSCPU's Internal I/F 4 points + I/O module)	
Clock function	Provided	
Security function	Password registration, Password for every Motion SFC programs, Software security key function <b>NEW</b>	
All clear function	Delete all user data in Motion CPU	
Remote operation	Remote RUN/STOP, Remote latch clear	
Digital oscilloscope function	Bit data: 16 channels, Word data: 16 channels <sup>(Note-4)</sup>	
Amplifier-less operation function	Provided	
Absolute position system	Made compatible by setting battery to servo amplifier. (Possible to select the absolute data method or incremental method for each axis)	
Number of SSCNETIII/H systems <sup>(Note-1)</sup>	2 systems	1 system
Number of Motion related modules	Q172DLX 4 modules usable	Q172DLX 4 modules usable
	Q172DEX 6 modules usable <sup>(Note-2)</sup>	Q172DEX 6 modules usable <sup>(Note-2)</sup>
	Q173DPX 4 modules usable <sup>(Note-3)</sup>	Q173DPX 4 modules usable <sup>(Note-3)</sup>

(Note-1): The SSCNETIII compatible servo amplifier can be used, but the SSCNET compatible servo amplifier cannot be used.

(Note-2): Q172DEX cannot be used in SV13.

(Note-3): When using the incremental synchronous (SV22 use), you can use the number of modules in the specification.

When connecting the manual pulse generator, you can use only 1 module.

(Note-4): 8CH word data and 8CH bit data can be displayed in real time.

(Note-5): When the manual pulse generator is used with the Q17nDSCPU's internal I/F, do not set the Q173DPX in the System Settings.

## Mechanical system program (SV22)

Item			Specifications			
			Q173DSCPU		Q172DSCPU	
Control unit	Drive module	Virtual servomotor	PLS			
		Synchronous encoder	PLS			
	Output module	Roller	mm, inch			
		Ball screw	mm, inch			
		Rotary table	Fixed as "degree"			
	Cam	mm, inch, degree, PLS		Ver.UP		
Mechanical system program	Drive module	Virtual servomotor	32	Total 44	16	Total 28
		Synchronous encoder	12		12	
	Virtual axis	Virtual main shaft	32	Total 64	16	Total 32
		Virtual auxiliary input axis	32		16	
	Transmission module	Gear <sup>(Note-1)</sup>	64		32	
		Clutch <sup>(Note-1)</sup>	64		32	
		Speed change gear <sup>(Note-1)</sup>	64		32	
		Differential gear <sup>(Note-1)</sup>	32		16	
		Differential gear (Connect to the virtual main shaft) <sup>(Note-2)</sup>	32		16	
	Output module	Roller	32	Total 32	16	Total 16
		Ball screw	32		16	
		Rotary table	32		16	
		Cam	32		16	
	Cam	Types	Up to 256			
Resolution per cycle		256, 512, 1024, 2048				
Memory capacity		132k bytes				
Stroke resolution		32767				
Control mode		Two-way cam, feed cam				

(Note-1): Use only one module for one output module. (one gear, clutch, speed change gear or differential gear module for one output module).

(Note-2): The differential gears connected to the virtual main shaft can be used only one module per one main shaft.

## Motion SFC performance

Item			Specifications			
			Q173DSCPU / Q172DSCPU			
Motion SFC program capacity	Code total (Motion SFC chart + Operation control + Transition)		652k bytes			
	Text total (Operation control + Transition)		668k bytes			
Motion SFC program	Number of Motion SFC programs		256 (No.0 to 255)			
	Motion SFC chart size/program		Up to 64k bytes (Included Motion SFC chart comments)			
	Number of Motion SFC steps/program		Up to 4094 steps			
	Number of selective branches/branch		255			
	Number of parallel branches/branch		255			
	Parallel branch nesting		Up to 4 levels			
Operation control program (F/FS) / Transition program (G)	Number of operation control programs		4096 with F (Once execution type) and FS (Scan execution type) combined (F/FS0 to F/FS4095)			
	Number of transition programs		4096 (G0 to G4095)			
	Code size/program		Up to approx. 64k bytes (32766 steps)			
	Number of blocks(line)/program		Up to 8192 blocks (In the case of 4 steps (min)/blocks)			
	Number of characters/block		Up to 128 (Comment included)			
	Number of operand/block		Up to 64 (Operand: Constants, Word devices, Bit devices)			
	( ) nesting/block		Up to 32			
Descriptive expression	Operation control program		Calculation expression, Bit conditional expression, Repetition process <b>NEW</b>			
	Transition program		Calculation expression, Bit conditional expression, Comparison conditional expression			
Execute specification	Number of multi executed programs		Up to 256			
	Number of multi active steps		Up to 256 steps per all programs			
	Executed task	Normal task		Executed in motion main cycle		
		Event task (Execution can be masked.)	Fixed cycle	Executed in fixed cycle (0.22 ms, 0.44 ms, 0.88 ms, 1.77 ms, 3.55 ms, 7.11 ms, 14.2 ms)		
			External interrupt	Executed when input ON is set among the input 16 points of interrupt module QI60		
PLC interrupt			Executed with interrupt instruction (D (P).GINT) from PLC CPU			
NMI task		Executed when input ON is set among the input 16 points of interrupt module QI60				
Number of I/O points (X/Y)			8192 points			
Number of real I/O points (PX/PY)			256 points			
Number of devices	Internal relays (M)		12288 points			
	Link relays (B)		8192 points			
	Annunciators (F)		2048 points			
	Special relays (SM)		2256 points			
	Data registers (D)		8192 points			
	Link registers (W)		8192 points			
	Special registers (SD)		2256 points			
	Motion registers (#)		12288 points			
	Coasting timers (FT)		1 point (888μs)			
Multiple CPU shared device		Up to 14336 points <sup>(Note-1)</sup>				

(Note-1): The number of usable points will differ depending on the system settings.



**Motion CPU module Q173DSCPU / Q172DSCPU**



Item		Q173DSCPU	Q172DSCPU
Number of control axes		Up to 32 axes	Up to 16 axes
Servo amplifier connection system		Connection by SSCNET III/H (2 systems)	Connection by SSCNET III/H (1 system)
Transmission Distance [m]		Connection by SSCNET III/H: 100 [m] Connection by SSCNET III: 50[m]	
Peripheral I/F		PERIPHERAL I/F, Via PLC CPU (USB/RS-232/Ethernet)	
Manual pulse generator operation function		Possible to connect 3 modules	
Synchronous encoder operation function		Possible to connect 12 modules <sup>(Note-1)</sup> (SV22 use)	
Controllable modules	Q172DLX	Up to 4 modules per CPU	Up to 2 modules per CPU
	Q172DEX	Up to 6 modules per CPU (SV22 use)	
	Q173DPX	Up to 4 modules per CPU (Incremental synchronous encoder use in SV22)	
	Q173DSXY	Up to 1 module per CPU (Only manual pulse generator use)	
	Input/output module	Up to 3 modules	
	Analogue module	Total : Up to 256 points per CPU	
Input signal	Number of input points	Up to 1 module per CPU	
	Input method	4 points	
Interface between manual pulse generator/incremental synchronous encoder	Signal input form	Positive Common/ Negative Common Shared Type (Photocoupler)	
	Input frequency	Phase A/ Phase B (magnification by 4)	
		1Mpps (After magnification by 4, up to 4Mpps) (Differential-output type) 200kpps (After magnification by 4, up to 800kpps) (voltage-output/Open-collector type )	
PLC extensions		Up to 7 base units	
5VDC internal current consumption [A]		1.75	1.44
Mass [kg]		0.38	
Exterior dimensions [mm(inch)]		120.5 (4.74)(H) × 27.4 (1.08)(W) × 120.3 (4.74)(D)	

(Note-1): Manual pulse generator and synchronous encoder are included.

**Safety signal module Q173DSXY**



Item		Specifications
Input signals	Number of input points	32 points × 2 systems (32 PLC CPU control points + 32 Motion CPU control points; 20 safety input points × 2 systems; 12 feedback input points for outputs × 2 systems)
	Input isolation method	Photocoupler
	Rated input voltage	24VDC (+10/-10%), Negative Common Type
	Rated input current	Approx. 4mA
	Input resistance	Approx. 8.2kΩ
	Input ON voltage / ON current	20VDC or more/3mA or more
	Input OFF voltage / OFF current	5VDC or less/1.7mA or less
	Input response time	PLC CPU control I/O: 10ms (digital filter's default value) Motion CPU control I/O: 15ms (CR filter)
Input common format	32 points/common (separate commons for the PLC CPU control I/O and the Motion CPU control I/O)	
Input operation indicator LED	32 points (indication for PLC CPU control)	
Output signals	Number of output points	12 points × 2 systems (12 PLC CPU control points + 12 Motion CPU control points)
	Output isolation format	Photocoupler
	Rated output voltage	24VDC (+10/-10%), Source type
	Max. load current	(0.1A × 8 points, 0.2A × 4 points) × 2 systems, common current: each connector 1.6A or less
	Max. inrush current	0.7A 10ms or less (1.4A 10ms or less for 0.2A output pin)
	Response time	1ms or less
	Output common format	12 points/common (separate commons for the PLC CPU control I/O and the Motion CPU control I/O)
	Output operation indicator LED	Shared with inputs
Safety specifications <sup>(Note-2)</sup>	Safety functions <sup>(Note-3)</sup>	STO, SS1, SS2, SOS, SLS, SBC, SSM (IEC61800-5-2: 2007)
	Safety performance	EN ISO13849-1: 2008 Category 3 PLd
	Mean time to dangerous failure (MTTFd)	24 years or more
	Diagnostic converge (DCavq)	Low
	Probability of dangerous Failure per Hour (PFH)	9.47 × 10 <sup>-7</sup>
	Number of I/O occupying points	32 points
Communication between PLC CPUs	Parallel bus communication (via main base unit)	
Communication between Motion CPUs	Serial communication (RS-485), RIO cable used	
Terminal block converter module	FA-LTB40P (manufactured by Mitsubishi Electric Engineering) A6TBXY36	
Connection cable	FA-CBL_FMV-M (provided with FA-LTB40P as a set), AC50TB (provided with A6TBXY36 as a set)	
Number of installed modules	Up to 3 modules (number of input points: 60 points × 2 systems; number of output points: 36 points × 2 systems)	
5V internal current consumption	200mA (TYP. all points ON)	
Mass [kg]	0.15	
Exterior dimensions [mm(inch)]	98 (3.86)(H) × 27.4 (1.08)(W) × 90 (3.54)(D)	

Note) Install Q173DSXY to the main base unit. Do not install to the extension base unit.

(Note-1): The safety function is structured by using the PLC CPU modules QnUD (E)(H) CPU and Q173DSXY.

QnUD (E)(H) CPU : Q03UDCPU, Q03UDECPU, Q04UDHCPU, Q04UDEHCPU, Q06UDHCPU, Q06UDEHCPU, Q10UDHCPU, Q10UDEHCPU, Q13UDHCPU, Q13UDEHCPU, Q20UDHCPU, Q20UDEHCPU, Q26UDHCPU, Q26UDEHCPU, Q50UDEHCPU, Q100UDEHCPU

(Note-2): The listed details are the minimum values for the standards pending certification.

(Note-3): TÜV Rheinland certification of the safety specifications is pending.

## Servo external signals interface module Q172DLX



Item		Specifications
External input signal (FLS, RLS, STOP, DOG)	Number of input points	Servo external control signals : 32 points, 8 axes
	Input method	Positive Common/ Negative Common Shared Type (Photocoupler)
	Rated input voltage/ current	12VDC 2mA, 24VDC 4mA
	Operating voltage range	10.2 to 26.4 VDC (Ripple ratio 5% or less)
	ON voltage/ current	10VDC or more/ 2.0mA or more
	OFF voltage/ current	1.8VDC or less/ 0.18mA or less
Response time	FLS, RLS, STOP	1ms (OFF to ON, ON to OFF)
	DOG	0.4ms, 0.6ms, 1ms (OFF to ON, ON to OFF) * CPU parameter setting, default 0.4ms
Number of I/O occupying points		32 points (I/O allocation: Intelligent, 32 points)
5VDC internal current consumption [A]		0.06
Mass [kg]		0.15
Exterior dimensions [mm (inch)]		98 (3.86)(H) × 27.4 (1.08)(W) × 90 (3.54)(D)

(Note) Motion modules (Q172DLX) cannot be installed in CPU slot and I/O slot 0 to 2 of the main base unit.

## Synchronous encoder interface module Q172DEX



Item		Specifications
Serial absolute synchronous encoder input	Number of modules	2 per module
	Applicable encoder	Q171ENC-W8
	Position detection method	Absolute (ABS) data method
	Transmission method	Serial communications (2.5Mbps)
	Back up battery	A6BAT/MR-BAT
Tracking enable input	Maximum cable length	50m
	Number of input points	2 points
	Input method	Positive Common/ Negative Common Shared Type (Photocoupler)
	Rated input voltage/current	12VDC 2mA, 24VDC 4mA
	Operating voltage range	10.2 to 26.4 VDC (Ripple ratio 5% or less)
	ON voltage/current	10VDC or more/2.0mA or more
OFF voltage/current	1.8VDC or less/0.18mA or less	
Response time	0.4ms, 0.6ms, 1ms (OFF to ON, ON to OFF) * CPU parameter setting, default 0.4ms	
Number of I/O occupying points		32 points ( I/O allocation: Intelligent, 32 points)
5VDC internal current consumption [A]		0.19
Mass [kg]		0.15
Exterior dimensions [mm (inch)]		98 (3.86)(H) × 27.4 (1.08)(W) × 90 (3.54)(D)

(Note-1) Motion modules (Q172DEX) cannot be installed in CPU slot and I/O slot 0 to 2 of the main base unit.  
(Note-2) Install Q172DEX to the main base unit. Do not install to the extension base unit.

## Manual pulse generator interface module Q173DPX



Item		Specifications	
Manual pulse generator/ incremental synchronous encoder input	Number of modules	3 per module	
	Voltage-output/ Open-collector type	High-voltage	3.0 to 5.25 VDC
		Low-voltage	0 to 1.0 VDC
	Differential-output type	High-voltage	2.0 to 5.25 VDC
		Low-voltage	0 to 0.8 VDC
	Input frequency	Up to 200kpps (After magnification by 4)	
	Applicable types	Voltage-output/ Open-collector type (5VDC), (Recommended product: MR-HDP01) Differential-output type (26LS31 or equivalent)	
Maximum cable length	Voltage-output/ Open-collector type: 10m (32.79ft.) Differential-output type: 30m (98.36ft.)		
Tracking enable input	Number of input points	3 points	
	Input method	Positive Common/ Negative Common Shared Type (Photocoupler)	
	Rated input voltage/current	12VDC 2mA, 24VDC 4mA	
	Operating voltage range	10.2 to 26.4 VDC (Ripple ratio 5% or less)	
	ON voltage/current	10VDC or more/ 2.0mA or more	
	OFF voltage/current	1.8VDC or less/ 0.18mA or less	
Response time	0.4ms, 0.6ms, 1ms (OFF to ON, ON to OFF) * CPU parameter setting, default 0.4ms		
Number of I/O occupying points		32 points ( I/O allocation: Intelligent, 32 points)	
5VDC internal current consumption [A]		0.38	
Mass [kg]		0.15	
Exterior dimensions [mm (inch)]		98(3.86)(H) × 27.4(1.08)(W) × 90(3.54)(D)	

(Note) Motion modules (Q173DPX) cannot be installed in CPU slot and I/O slot 0 to 2 of the main base unit.





## Exterior Dimensions

Motion CPU module Q173DSCPU

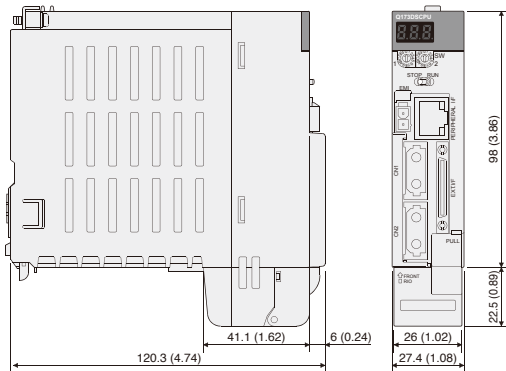

[Unit : mm (inch)]

Motion CPU module Q172DSCPU

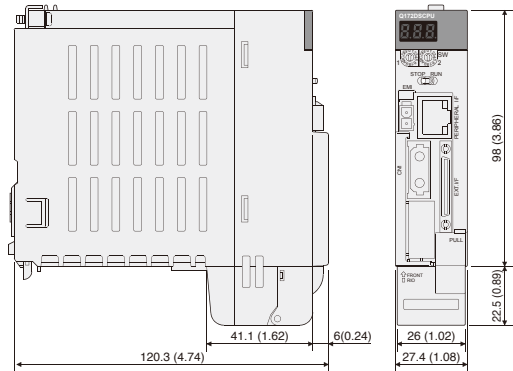

[Unit : mm (inch)]

Servo external signals interface module Q172DLX

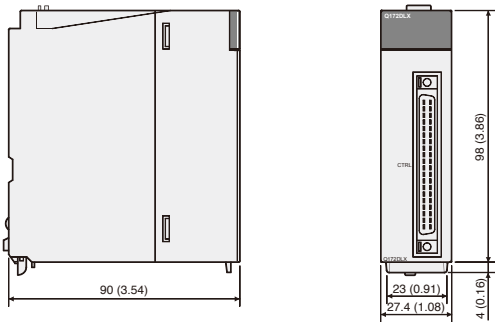

[Unit : mm (inch)]

Synchronous encoder interface module Q172DEX

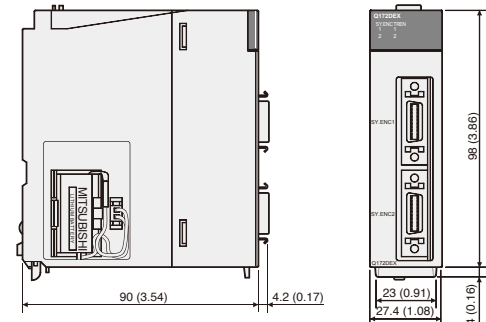

[Unit : mm (inch)]

Manual pulse generator interface module Q173DPX

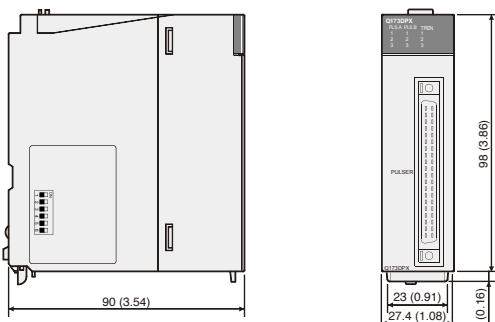

[Unit : mm (inch)]

Safety signal module Q173DSXY

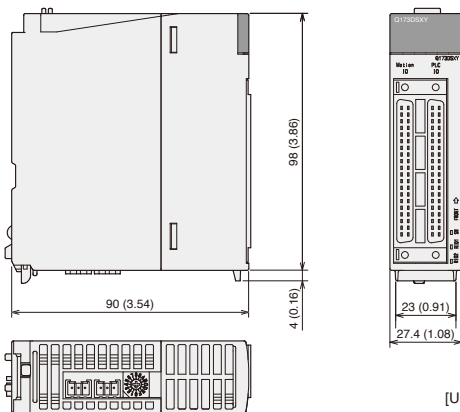

[Unit : mm (inch)]

## Mounting

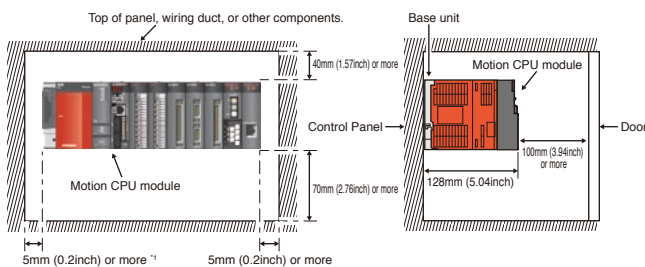

\*1 When the extension cable is connected without removing the adjacent module: 20mm (0.79inch) or more.  
 Note) The main base unit cannot be mounted with the DIN rail when using the Motion CPU module.

### Serial absolute synchronous encoder Q171ENC-W8

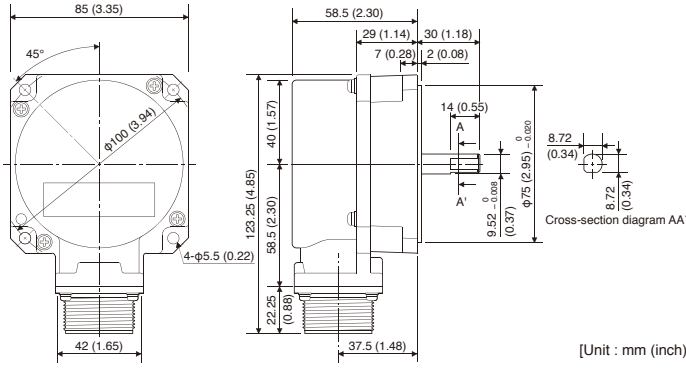

Item	Specifications
Resolution	4194304PLS/rev
Direction of increasing addresses	CCW (viewed from end of shaft)
Protective construction	Dustproof/Waterproof (IP67: Except for the shaft-through portion)
Permitted axial loads	Radial load: Up to 19.6N Thrust load: Up to 9.8N
Permitted speed	3600r/min
Permitted angular acceleration	40000rad/s <sup>2</sup>
Ambient temperature	-5 to 55°C
5VDC consumption current	0.25A
Mass	0.6kg

[Unit : mm (inch)]

### Manual pulse generator MR-HDP01

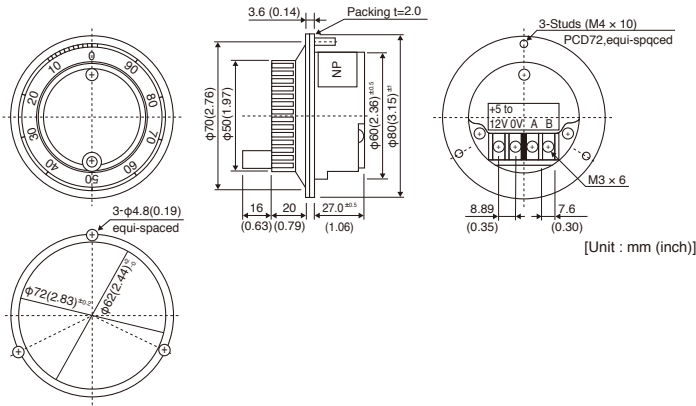

Item	Specifications
Pulse resolution	25PLS/rev (100PLS/rev after magnification by 4)
Phase A/Phase B Output voltage	Input voltage : -1V or more (Note)
Output method	Output voltage
Output current	Up to 20mA
Life time	1,000,000 revolutions or more (at 200r/min)
Permitted axial loads	Radial load: Up to 19.6N Thrust load: Up to 9.8N
Maximum rotation speed	600r/min (Instantaneous maximum), 200r/min (Normal rotation)
Ambient temperature	-10 to 60 °C
5VDC consumption current	0.06A
Mass	0.4kg

(Note) When using an external power supply, use 5V power supply.

### Base unit

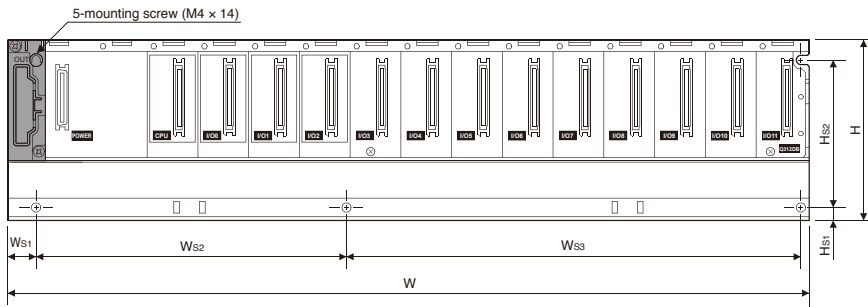

	Q35DB	Q38DB	Q312DB	Q63B	Q65B	Q68B	Q612B
W	245 (9.65)	328 (12.92)	439 (17.30)	189 (7.44)	245 (9.65)	328 (12.92)	439 (17.30)
Ws1	15.5 (0.61)						
Ws2	224.5±0.3 (8.84±0.01)	170±0.3 (6.69±0.01)	170±0.3 (6.69±0.01)	167±0.3 (6.57±0.01)	222.5±0.3 (8.76±0.01)	190±0.3 (7.48±0.01)	190±0.3 (7.48±0.01)
Ws3	(Ws2+Ws3)	138±0.3 (5.43±0.01)	249±0.3 (9.80±0.01)	(Ws2+Ws3)	(Ws2+Ws3)	116±0.3 (4.57±0.01)	227±0.3 (8.94±0.01)
H	98 (3.86)						
Hs1	7 (0.28)						
Hs2	80±0.3 (3.15±0.01)						

[Unit : mm (inch)]



## Motion controller module configuration equipment

### <Motion dedicated equipments>

Part name	Model name	Description	Standards
Motion CPU module	Q173DSCPU	Up to 32 axes control, Operation cycle 0.22 ms or more (Attachment battery (Q6BAT))	CE, UL
	Q172DSCPU	Up to 16 axes control, Operation cycle 0.22 ms or more (Attachment battery (Q6BAT))	CE, UL
Cable for force stop input <sup>(Note-1)</sup>	Q170DEMICBL05M	Forced stop input (Be sure to order with Motion CPU modules)	0.5m (1.64ft.)
	Q170DEMICBL1M		1m (3.28ft.)
	Q170DEMICBL3M		3m (9.84ft.)
	Q170DEMICBL5M		5m (16.40ft.)
	Q170DEMICBL10M		10m(32.81ft.)
	Q170DEMICBL15M		15m(49.21ft.)
	Q170DEMICBL20M		20m(65.62ft.)
	Q170DEMICBL25M		25m(82.02ft.)
Connector for forced stop input cable	Q170DEMICON	Connector for forced stop input cable (Be sure to order when you make the forced stop input cable)	—
	MR-J3BUS_M	Q17nDSCPU⇔MR-J4-B MR-J4-B⇔MR-J4-B	Standard cord for inside panel 0.15m (0.49ft.), 0.3m (0.98ft.), 0.5m (1.64ft.), 1m (3.28ft.), 3m (9.84ft.)
MR-J3BUS_M-A	Standard cable for outside panel 5m (16.40ft.), 10m (32.81ft.), 20m (65.62ft.)		
MR-J3BUS_M-B <sup>(Note-2)</sup>	Long distance cable 30m (98.43ft.), 40m (131.23ft.), 50m (164.04ft.)		
Servo external signals interface module	Q172DLX	Servo external signal input 8 axes (FLS, RLS, STOP, DOG×8)	CE, UL
Synchronous encoder interface module	Q172DEX	Serial absolute synchronous encoder Q171ENC-W8 interface×2, Tracking input 2 points, with A6BAT	CE, UL
Manual pulse generator interface module	Q173DPX	Manual pulse generator MR-HDP01/ Incremental synchronous encoder interface ×3, Tracking input 3 points	CE, UL
Safety signal module	Q173DSXY	Attachment RIO cable (Q173DSXYCBL01M)	CE, UL
Serial absolute synchronous encoder	Q171ENC-W8	Resolution: 4194304PLS/rev, Permitted speed: 3600r/min	CE, UL
Serial absolute synchronous encoder cable	Q170ENCCBL_M	Serial absolute synchronous encoder Q171ENC-W8⇔Q172DEX	2m (6.56ft.)
			5m (16.40ft.)
			10m (32.81ft.)
			20m (65.62ft.)
			30m (98.43ft.)
Internal I/F connector set	Q170DSIOCON	Incremental synchronous encoder/ Mark detection signal interface connector set	—
	Q173DSXYCBL01M	Q17nDSCPU⇔Q173DSXY	0.1m (0.44ft.)
RIO cable	Q173DSXYCBL05M	Q173DSXY⇔Q173DSXY	0.5m (1.64ft.)
	Q6BAT	For memory data backup of SRAM built-in Motion CPU (program, parameter, absolute position data, latch data)	—
Battery	A6BAT	For data backup of Q171ENC-W8	—
	MR-HDP01	Pulse resolution: 25PLS/rev(100PLS/rev after magnification by 4) Permitted speed: 200r/min(Normal rotation)	—

(Note-1): Be sure to use the cable for forced stop input. The forced stop cannot be released without using it.

(Note-2): Please contact your nearest Mitsubishi sales representative for 100m (328.08ft.) or shorter of long distance cable or ultra-long bending life cable.

(Note-3): " " indicates cable length (015: 0.15m (0.49ft.), 03: 0.3m (0.98ft.), 05: 0.5m (1.64ft.), 1: 1m (3.28ft.), 3: 3m (9.84ft.), 5: 5m (16.40ft.), 10: 10m (32.81ft.), 20: 20m (65.62ft.), 30: 30m (98.43ft.), 40: 40m (131.23ft.), 50: 50m (164.04ft.))

### <PLC common equipments>

Part name	Model name	Standards
PLC CPU module	Q03UDCPU, Q03UDECPU, Q04UDHCPU, Q04UDEHCPU, Q06UDHCPU, Q06UDEHCPU, Q10UDHCPU, Q10UDEHCPU, Q13UDHCPU, Q13UDEHCPU, Q20UDHCPU, Q20UDEHCPU, Q26UDHCPU, Q26UDEHCPU, Q50UDEHCPU, Q100UDEHCPU	CE, UL
C Controller CPU module	Q12DCCPU-V	CE, UL
CPU base unit	Q35DB, Q38DB, Q312DB	CE, UL
Extension base unit	Q63B, Q65B, Q68B, Q612B, Q52B, Q55B	CE, UL
Extension cable	QC05B, QC06B, QC12B, QC30B, QC50B, QC100B	—
Power supply module <sup>(Note-1)</sup>	Q61P, Q62P, Q63P, Q64PN, Q61P-D	CE, UL
Input/output module	Input module, Output module, Input/Output composite module	CE, UL
Analogue module	Q68ADV, Q62AD-DGH, Q66AD-DG, Q68ADI, Q64AD, Q64AD-GH, Q68AD-G, Q68DAVN, Q68DAIN, Q62DAN, Q62DA-FG, Q64DAN, Q66DA-G	CE, UL
Interrupt module	Q160	CE, UL

(Note-1): Please use the power supply module within the range of power supply capacity.

## List of Motion controller module software

### <Operating system software> <sup>(Note-1)</sup>

Application	Model name	
	Q173DSCPU	Q172DSCPU
Conveyor assembly use SV13	SW8DNC-SV13QJ	SW8DNC-SV13QL
Automatic machinery use SV22	SW8DNC-SV22QJ	SW8DNC-SV22QL

Product	Model name	Description
Operating system software set for Q173DSCPU/Q172DSCPU	SW8DNC-SV1322QJLSET	SW8DNC-SV13QJ, SW8DNC-SV13QL
		SW8DNC-SV22QJ, SW8DNC-SV22QL

(Note-1): Operating system software (SV22) is Pre-installed into Motion controller before shipment  
SW8DNC-SV1322QJLSET<CD-ROM> that includes all operating system software in the table above is also available.



### <MELSEC-Q series engineering environment>

Product	Model name	Description	Application version
MELSOFT MT Works2 <sup>(Note-2)</sup>	SW1DNC-MTW2-E	Conveyor assembly use SV13 Automatic machinery use SV22	1.34L
	SW1DNC-MTW2-EAZ	Additional license product (1 license)	1.34L
	SW1DNC-MTW2-EC	Site license	1.34L
MELSOFT GX Works2 <sup>(Note-2)</sup>	SW1DNC-GXW2-E	Sequence program creation	—
MELSOFT MR Configurator2	SW1DNC-MRC2-E <sup>(Note-1)</sup>	Servo amplifier MR-J4 series setting and adjustment	1.09K

(Note-1): MELSOFT MR Configurator2 is included in MELSOFT MT Works2 as standard.

(Note-2): MELSOFT IQ Works includes MELSOFT GX Works2 and MELSOFT MT Works2.

### < MELSOFT operating environment> IBM PC/AT with which Windows® 7/ Windows Vista®/ Windows® XP/ Windows® 2000 English version operated normally.

Item	Description
OS	Microsoft® Windows® 7 (64bit/32bit) (Enterprise, Ultimate, Professional, Home Premium, Starter)
	Microsoft® Windows Vista® (32bit) (Enterprise, Ultimate, Business, Home Premium, Home Basic)
	Microsoft® Windows® XP Service Pack2 or later (32bit) (Professional, Home Edition)
	Microsoft® Windows® 2000 Professional Service Pack4
CPU	Desktop: Intel® Celeron® 2.8 GHz or more Laptop: Intel® Pentium® M 1.7 GHz or more
Required memory	Recommended 1GB or more
Available hard disk capacity	When installing MT Works2: HDD available capacity is 1GB or more. When operating MT Works2: Virtual memory available capacity is 512MB or more.
Optical drive	CD-ROM supported disk drive
Monitor	Resolution 1024 × 768 pixels or higher





## Simple Motion module specifications

### Motion control



Item		Specifications			
		QD77MS16	QD77MS4	QD77MS2 <sup>3</sup>	
Number of control axes		16 axes <b>NEW</b>	4 axes	2 axes	
Operation cycle		0.88 ms/ 1.77 ms <sup>1</sup>	0.88 ms	0.88 ms	
Interpolation function		Linear interpolation (Up to 4 axes), Circular interpolation (2 axes)			
Control system		PTP (Point To Point) control, Path control (both linear and arc can be set), Speed control, Torque control, Speed-position switching control, Position-speed switching control			
Acceleration/deceleration process		Trapezoidal acceleration/deceleration, S-pattern acceleration/deceleration			
Compensation function		Backlash compensation, Electronic gear, Near pass function			
Synchronous control		External encoder, Cam, Phase Compensation, Cam auto-generation function <b>NEW</b>			
Control unit		mm, inch, degree, PLS			
Positioning data		600 data (positioning data No. 1 to 600)/axis (Can be set with MELSOFT GX Works2 or Sequence program.)			
Backup		Parameters, positioning data, and block start data can be saved on flash ROM (battery-less backup)			
OPR control	Machine OPR control	Near-point dog method, Count method 1, Count method 2, Data set method, Scale origin signal detection method <b>Ver.UP</b>			
	Fast OPR control	Provided			
	Sub functions	OPR retry, OP shift			
positioning control	Position control	Linear control	1-axis linear control, 2-axis linear interpolation control, 3-axis linear interpolation control, 4-axis linear interpolation control <sup>4</sup> (Composite speed, Reference axis speed)		
		Fixed-feed control	1-axis fixed-feed control, 2-axis fixed-feed control, 3-axis fixed-feed control, 4-axis fixed-feed control		
		2-axis circular interpolation control	Sub point designation, center point designation		
	Speed control	1-axis speed control, 2-axis speed control, 3-axis speed control, 4-axis speed control			
	Speed-position switching control	INC mode, ABS mode			
	Position-speed switching control	INC mode			
	Other control	Current value changing	Changing to a new current value using the positioning data , Changing to a new current value using the start No.		
		NOP instruction	Provided		
		JUMP instruction	Unconditional JUMP, Conditional JUMP		
		LOOP, LEND	Provided		
High-level positioning control		Block start, Condition start, Wait start, Simultaneous start, Repeated start			
Manual control	JOG operation	Provided			
	Inching operation	Provided			
	Manual pulse generator operation	Possible to connect 1 module (Incremental) Unit magnification (1 to 10000 times)			
Expansion control	Speed-torque control	Speed control without positioning loops, Torque control without positioning loops, Tightening & Press-fit control <b>NEW</b>			
Absolute position system		Made compatible by setting battery to servo amplifier			
Synchronous encoder interface		Up to 4 channel (internal interface , servo amplifier, via the PLC CPU interface )			
		Internal interface	1 channel (Incremental)		
Functions that limit control	Speed limit function	Speed limit value, JOG speed limit value			
	Torque limit function	Torque limit value_same setting, torque limit value_individual setting			
	Forced stop function	Valid/Invalid setting			
	Software stroke limit function	Movable range check with current feed value, movable range check with machine feed value			
	Hardware stroke limit function	Provided			
Functions that change control details	Speed change function	Provided			
	Override function	Provided			
	Acceleration/deceleration time change function	Provided			
	Torque change function	Provided			
	Target position change function	Target position address and target position speed are changeable			
Other functions	M code output function	Provided			
	Step function	Deceleration unit step, Data No. unit step			
	Skip function	Via sequence CPU, Via external command signal			
	Teaching function	Provided			
Mark detection function	Continuous Detection mode, Specified Number of Detections mode, Ring Buffer mode <b>NEW</b>				
	Mark detection signal	4 points		2 points	
	Mark detection setting	16	4		
Optional data monitor function		4 points/axis <b>NEW</b>			
Amplifier-less operation function		Provided <b>NEW</b>			
Digital oscilloscope function <sup>2</sup>		Bit data:16 channels, Word data: 16 channels	Bit data: 8 channels, Word data: 4 channels	<b>NEW</b>	

<sup>1</sup> Default value is 1.77 ms. If necessary, check the operation time and change to 0.88 ms.

<sup>2</sup> 8CH word data and 8CH bit data can be displayed in real time.

<sup>3</sup> The maximum number of control axes for QD77MS2 is two axes. Use QD77MS4 or QD77MS16 to control three or more axes.

<sup>4</sup> 4-axis linear interpolation control is effective only for the reference axis speed.

## Synchronous control

Item		Specifications		
		QD77MS16	QD77MS4	QD77MS2
Input axis	Servo input axis	16 axes/module	4 axes/module	2 axes/module
	Synchronous encoder axis		4 axes/module	
Composite main shaft gear			1 /output axis	
Main shaft input axis			1 /output axis	
Main shaft sub input axis			1 /output axis	
Main shaft gear			1 /output axis	
Main shaft clutch			1 /output axis	
Auxiliary shaft			1 /output axis	
Auxiliary shaft gear			1 /output axis	
Auxiliary shaft clutch			1 /output axis	
Auxiliary shaft composite gear			1 /output axis	
Speed change gear			1 /output axis	
Output axis		16 axes/module	4 axes/module	2 axes/module

## Cam

Item			Specifications
Memory capacity	Storage area for cam data		256k bytes
	Working area for cam data		1024k bytes
Number of registration			Max. 256 program items (depending on memory capacity, cam resolution and number of coordinates)
Comment			Max. 32 characters (half-byte) for each cam data
Cam data	Stroke ratio data type	Cam resolution	256, 512, 1024, 2048, 4096, 8192, 16384, 32768
		Stroke ratio	-214.7483648 to 214.7483647 [%]
	Coordinate data type	Coordinate number	2 to 16384
		Coordinate data	Input value: 0 to 2147483647 Output value: -2147483648 to 2147483647
Cam auto-generation			Cam auto-generation for rotary cutter

## Module

Item			Specifications			
			QD77MS16	QD77MS4	QD77MS2	
Servo amplifier connection system			Connection with SSCNET III/H (1 system)			
Maximum transmission distance between servo amplifiers			Connection with SSCNET III/H: 100m Connection with SSCNET III possible: 50m			
Peripheral I/F			Via CPU module (USB, RS-232, Ethernet)			
Interface with external devices	Near-point dog signal (DOG) External command signal/ Switching signal	Number of input points	4 points		2 points	
		Input method	Positive common/ Negative common shared (Photocoupler)			
		Rated input voltage/Rated input current	24 VDC/ Approx. 5 mA			
		Operating voltage range	19.2 to 26.4 VDC (24 VDC +10%/-20%, ripple ratio 5% or less)			
		ON voltage/current	17.5 VDC or more/ 3.5 mA or more			
		OFF voltage/current	7 VDC or less/ 1.0 mA or less			
		Input resistance	Approx 6.8 kΩ			
		Response time	1 ms or less			
	Recommended wire size	AWG24 (0.2 mm <sup>2</sup> )				
	Specifications of forced stop input signal Upper limit signal (FLS) Lower limit signal (RLS) Stop signal (STOP)	Number of input points	4 points, 1 point (EMI)		2 points, 1 point (EMI)	
		Input method	Positive common/ Negative common shared (Photocoupler)			
		Rated input voltage/Rated input current	24 VDC/ Approx. 5 mA			
		Operating voltage range	19.2 to 26.4VDC (24VDC +10%/-20%, ripple ratio 5% or less)			
		ON voltage/current	17.5 VDC or more/ 3.5 mA or more			
		OFF voltage/current	7 VDC or less/ 1.0 mA or less			
		Input resistance	Approx 6.8 kΩ			
		Response time	4 ms or less			
	Recommended wire size	AWG24 (0.2 mm <sup>2</sup> )				
	Manual pulse generator/ Incremental synchronous encoder signal	Signal input form	Phase A/Phase B (magnification by 4/magnification by 2/magnification by 1), PLS/SIGN			
			Differential-output type	Input frequency	1Mpps (After magnification by 4, up to 4 Mpps)	
High-voltage		2.0 to 5.25 VDC				
Low-voltage		0 to 0.8 VDC				
Differential-voltage		+/- 0.2VDC				
Voltage-output/ Open-collector type (5VDC)		Cable length	Maximum 30 m (98.43ft.)			
		Input frequency	200 kpps (After magnification by 4, up to 800 kpps)			
		High-voltage	3.0 to 5.25 VDC			
		Low-voltage	0 to 1.0 VDC			
		Cable length	Maximum 10 m (32.81ft.)			
	Number of I/O occupying points	32 points (I/O allocation: Intelligent function module, 32 points)				
Maximum number of modules specification			1			
5VDC internal current consumption [A]			0.75	0.6		
Mass [kg]			0.16		0.15	
Exterior dimensions [mm(inch)]			98.0 (3.86)(H) × 27.4 (1.08)(W) × 90.0 (3.54)(D)			



## Exterior Dimensions

### Simple Motion module QD77MS16

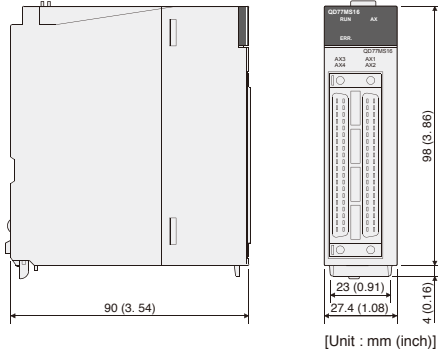

### Simple Motion module QD77MS4

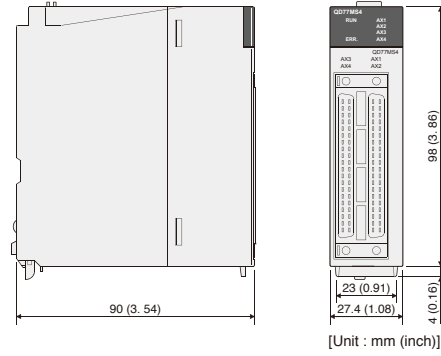

### Simple Motion module QD77MS2

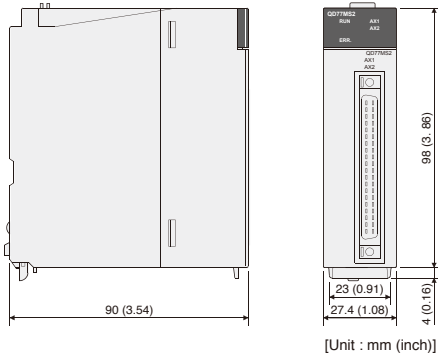

### Manual pulse generator MR-HDP01

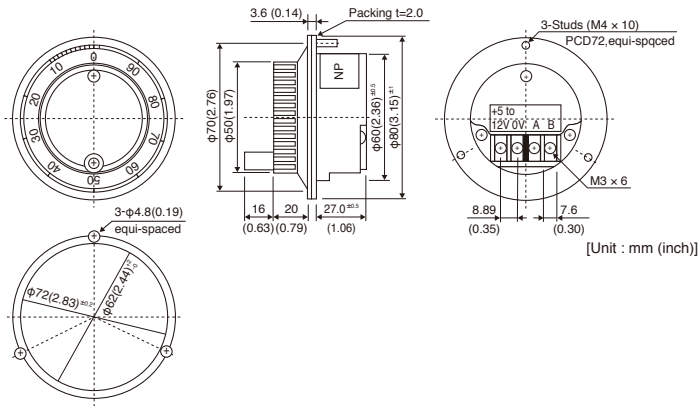

Item	Specifications
Pulse resolution	25PLS/rev (100PLS/rev after magnification by 4)
Phase A/Phase B Output voltage	Input voltage : -1V or more <sup>(Note)</sup>
Output method	Output voltage
Output current	Up to 20mA
Life time	1,000,000 revolutions or more (at 200r/min)
Permitted axial loads	Radial load: Up to 19.6N Thrust load: Up to 9.8N
Maximum rotation speed	600r/min (Instantaneous maximum), 200r/min (Normal rotation)
Ambient temperature	-10 to 60 °C
5VDC consumption current	0.06A
Mass	0.4kg

(Note) When using an external power supply, use 5V power supply.

## Simple Motion module configuration equipment

### <Simple Motion dedicated module>

Part name	Model name	Description		Standards	
MELSEC-Q Series Simple Motion Module	QD77MS16	Up to 16 axes control		CE, UL	
	QD77MS4	Up to 4 axes control		CE, UL	
	QD77MS2	Up to 2 axes control		CE, UL	
SSCNETIII cable <sup>(Note-1)</sup>	MR-J3BUS_M	· QD77MS⇔MR-J4-B · MR-J4-B⇔MR-J4-B	Standard code for inside panel	0.15m (0.49ft.), 0.3m (0.98ft.), 0.5m (1.64ft.), 1m (3.28ft.), 3m (9.84ft)	—
	MR-J3BUS_M-A		Standard code for outside panel	5m (16.40ft.), 10m (32.81ft.), 20m (65.62ft.)	—
	MR-J3BUS_M-B <sup>(Note-2)</sup>		Long distance cable	30m (98.43ft.), 40m (131.23ft.), 50m (164.04ft.)	—
Manual pulse generator	MR-HDP01	Pulse resolution: 25PLS/rev (100PLS/rev after magnification by 4), Permitted speed: 200r/min (Normal rotation)		—	

(Note-1): Please contact your nearest Mitsubishi sales representative for 100m (328.08ft.) or shorter of long distance cable or ultra-long bending life cable.

(Note-2): "\_" indicates cable length (015: 0.15m (0.49ft.), 03: 0.3m (0.98ft.), 05: 0.5m (1.64ft.), 1: 1m (3.28ft.), 3: 3m (9.84ft.), 5: 5m (16.40ft.), 10: 10m (32.81ft.), 20: 20m (65.62ft.), 30: 30m (98.43ft.), 40: 40m (131.23ft.), 50: 50m (164.04ft.)



## List of Simple Motion module software

### <MELSEC-Q series engineering environment>

Product	Model name	Description	Application version
MELSOFT GX Works2	SW1DNC-GXW2-E	Sequence program creation, QD77MS setting	1.77F
MELSOFT MR Configurator2	SW1DNC-MRC2-E	Servo amplifier MR-J4 series setting and adjustment	1.09K

< Operating environment > IBM PC/AT with which Windows® 7/ Windows Vista®/ Windows® XP/ Windows® 2000 English version operated normally.

Item	Description
OS	Microsoft® Windows® 7 (64bit/32bit) (Enterprise, Ultimate, Professional, Home Premium, Starter) Microsoft® Windows Vista® (32bit) (Enterprise, Ultimate, Business, Home Premium, Home Basic) Microsoft® Windows® XP Service Pack2 or later (32bit) (Professional, Home Edition) Microsoft® Windows® 2000 Professional Service Pack4
CPU	Intel® Core™2 Duo Processor 2GHz or more
Required memory	Recommended 1GB or more
Available hard disk capacity	When installing MT Works2: HDD available capacity is 2.5GB or more. When operating MT Works2: Virtual memory available capacity is 512MB or more.
Optical drive	CD-ROM supported disk drive
Monitor	Resolution 1024 × 768 pixels or higher

# A global support network for MELSERVO users

## Global FA Center

Across the globe, FA Centers provide customers with local assistance for purchasing Mitsubishi Electric products and with after-sales service. To enable national branch offices and local representatives to work together in responding to local needs, we have developed a service network throughout the world. We provide repairs, on-site engineering support, and sales of replacement parts. We also provide various services from technical consulting services by our expert engineers to practical training for equipment operations.



**Ratingen, Germany**  
German FA Center/  
Europe Development Center



**Krakowska, Poland**  
European FA Center (Poland)



**St. Petersburg, Russia**  
Russian FA Center



**Gurgaon, India**  
India FA Center



**Bangkok, Thailand**  
Thailand FA Center



**Hatfield, UK**  
UK FA Center



**Praha, Czech Republic**  
Czech Republic FA Center

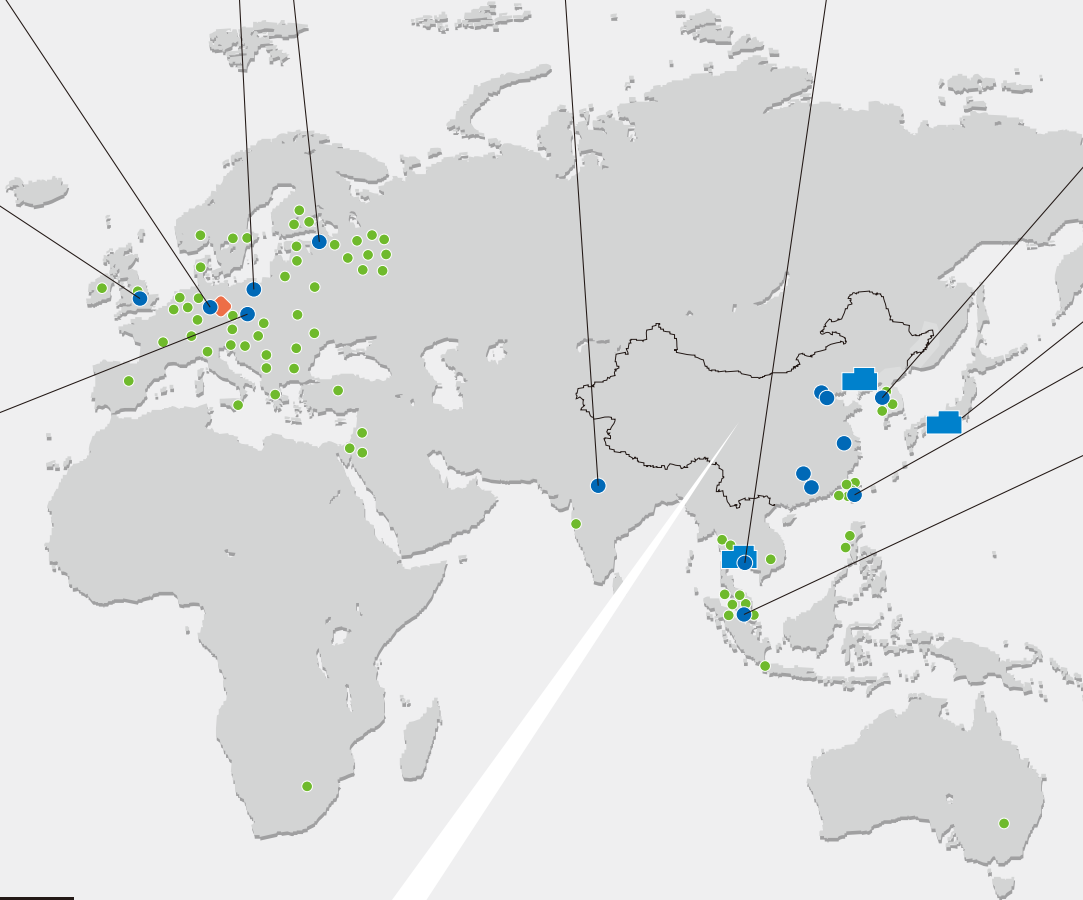

## China (including Hong Kong District)



**Beijing, China**  
Beijing FA Center



**Tianjin, China**  
Tianjin FA Center



**Guangzhou, China**  
Guangzhou FA Center

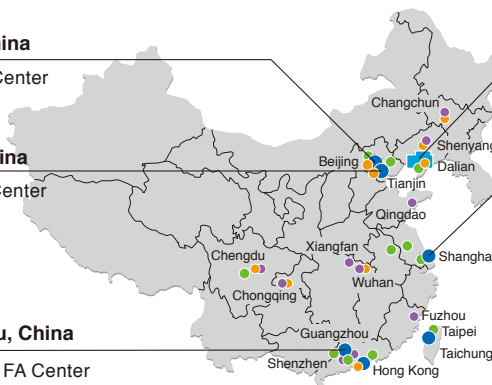

### Dalian, China

China Local Factory  
Mitsubishi Electric Dalian  
Industrial Products Co., Ltd.



### Shanghai, China

Shanghai FA Center





- Global FA Center
- FA Center Satellite (China)
- Mechatronics Service Base (China)
- Mitsubishi Sales Offices
- Production Facility
- ◆ Development Center



**Seoul, Korea**  
Korean FA Center



**Nagoya, Japan**  
Nagoya Works



**Taiwan**  
Left: Taiwan FA Center (Taipei) /  
Right: Taiwan FA Center (Taichung)



**Singapore**  
ASEAN FA Center



**Chicago IL, USA**  
North American FA Center/  
North American Development Center

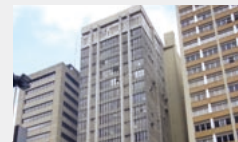

**Sao Paulo SP, Brazil**  
Brazil FA Center



Regions	Global FA Center	Tel/Fax
China	Shanghai FA Center	Tel: 86-21-2322-3030/Fax: 86-21-2322-3000
	Beijing FA Center	Tel: 86-10-6518-8830/Fax: 86-10-6518-3907
	Tianjin FA Center	Tel: 86-22-2813-1015/Fax: 86-22-2813-1017
	Guangzhou FA Center	Tel: 86-20-8923-6730/Fax: 86-20-8923-6715
Taiwan	Taiwan FA Center	Tel: 886-2-2299-9917/Fax: 886-2-2299-9963
Korea	Korean FA Center	Tel: 82-2-3660-9630/Fax: 82-2-3663-0475
Thailand	Thailand FA Center	Tel: 66-2906-3238/Fax: 66-2906-3239

Regions	Global FA Center	Tel/Fax
ASEAN/ India	ASEAN FA Center	Tel: 65-6470-2480/Fax: 65-6476-7439
	India FA Center	Tel: 91-124-4630300/Fax: 91-124-4630399
North/ Central/ South America	North American FA Center	Tel: 1-847-478-2100/Fax: 1-847-478-2253
	Brazil FA Center	Tel: 55-11-3146-2200/Fax: 55-11-3146-2217
Europe	European FA Center	Tel: 48-12-630-47-00/Fax: 48-12-630-47-01
	German FA Center	Tel: 49-2102-486-0/Fax: 49-2102-486-1120
	UK FA Center	Tel: 44-1707-27-6100/Fax: 44-1707-27-8695
	Czech Republic FA Center	Tel: 420-251-551-470/Fax: 420-251-551-471
	Russian FA Center	Tel: 7-812-633-3497/Fax: 7-812-633-3499

As a recognized leader in factory automation, Mitsubishi Electric is committed to maintaining a world-class level of customer satisfaction in every area of development, production, and service.

## Unrivalled engineering quality and craftsmanship backed by over 80 years of proven expertise

For more than 80 years from the start of operations in 1924, Mitsubishi Electric Nagoya Works has manufactured various universal devices including motors, programmable controllers and inverters. The history of AC servo production at Nagoya Works spans over 30 years. We have expanded our production system based on the technology and tradition amassed during this time, and have incorporated world-class research and development to create high-performance, high-quality products that can be supplied for a long time.

### Production system

To guarantee the high quality and performance of MELSERVO, Mitsubishi Electric has built a cooperative system of three facilities - Shinshiro Factory, a branch factory of Nagoya Works; Mitsubishi Electric Dalian Industrial Products Co., Ltd., a manufacturing base; and Nagoya Works at the core. Mitsubishi Electric responds to various needs throughout the world by uniting technologies and know-hows of these facilities. Mitsubishi Electric's FA energy solutions, "e&eco-F@ctory", are at work in the servo motor factory at the Nagoya Works. They are being used to boost capacity utilization and product quality, and reduce energy consumption.



Mitsubishi Electric Nagoya Works



e&eco-F@ctory implementation

### Development system

To spread advanced servo systems to the world as quickly as possible, Mitsubishi Electric has established FA-related development centers at its Nagoya Works, and in North America and Europe. Furthermore, we have established strong connections between our Advanced Technology R&D Center, which pushes technology development beyond the limits of FA, and Information Technology R&D Center. We are moving forward with the development of new products that reflect the latest technological directions and customer input.



FA Development Center



EDC (Europe Development Center)

Promoting the popularity of SSCNET in Japan and around the world

## SSCNET Partner Association (SNP)



The SSCNET Partner Association (SNP) carries activities to introduce the advanced servo system controller network "SSCNET III" and compatible products to many users. In cooperation with partner corporations, SNP widely promotes the performance attainable with SSCNET. In recent years, SNP holds partner meetings in Japan and overseas such as Taiwan and India. SNP aims to make SSCNET a more global servo system controller network.



Transition of number of SSCNET nodes introduced

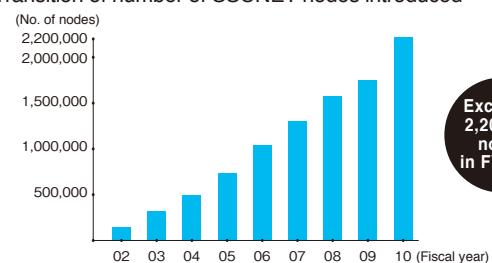

# About warrantee

Before using the Product, please check our product warrantee conditions below.

## 1. Period and scope of warrantee

Should a defect or a failure (hereafter referred to as "failure") occurs with the Product due to a reason or a cause attributable to Mitsubishi Electric Corporation (the Manufacturer), the Manufacturer will repair the Product free of charge through your local dealer or supplier.

Should Manufacturer's service engineer need to travel to the site for repair within Japan or overseas, however, the Purchaser shall bear the actual travel expenses. The scope of warrantee shall not cover any readjustment or test operation at the site in relation to replacing the failed Product.

### [Warrantee period]

The Manufacturer warrants the Product against a defect or a failure of the Product attributable to the Manufacturer for 36 months from the date of purchase or the date of Product delivery at the purchaser designated site.

Assuming the maximum logistics and/or retail period of six months after shipping the Product from the Manufacturer, the warrantee period shall not exceed 42 months. The warrantee period of the repaired Product shall not be extended beyond the warrantee period of the Product before repair.

### [Scope of warrantee]

- (1) Unless specified or agreed otherwise, the Purchaser is responsible for the primary failure diagnosis.  
The Manufacturer or Manufacturer's service representative or agent may perform the primary failure diagnosis for the Purchaser on a separate contract basis if so requested.  
However, the primary failure diagnosis shall be free of charge should the defect or failure so revealed be attributable to the Manufacturer.
- (2) The Manufacturer warrants the Product only if the Product is used correctly and properly under the normal operating conditions and environment in accordance with the conditions, precautions and instructions specified in such means as the operation manual, user's manual and caution labels affixed to the Product.
- (3) The Manufacturer's warrantee shall not apply in the following events.
  - ① The failure of the Product is attributable to the Purchaser such as incorrect, inadequate or improper storage, handling and operation or to the Purchaser's hardware or software design;
  - ② The failure is caused by any modification to the Product by the Purchaser without Manufacturer's prior consent;
  - ③ Where the Product is incorporated into Purchaser's equipment, the failure of the Product is considered to have been avoidable if the Purchaser's equipment was equipped with the regulatory safety devices or with the functions and/or structures considered to be necessary according to the industry's normal practice;
  - ④ The failure of the Product is considered to have been avoidable if the consumable items specified in the operation manual and other documents were maintained or replaced normally and properly;
  - ⑤ Replacement of consumables such as the battery and fan;
  - ⑥ Any failure of the product due to external causes such as a fire and abnormal power supply or to events beyond control such as natural disasters including an earthquake, lightning, storm or flood;
  - ⑦ Any failure that is unforeseeable by the technical or scientific level of industry at the time of the product delivery, and;
  - ⑧ Any failure due to a cause for which the Manufacturer is not held responsible or the Purchaser acknowledges as such.

## 2. Repair service availability after cease of production

- (1) The Manufacturer may accept the Product for repair on a separate contract basis within seven years after the date when the Manufacturer ceases to produce this particular product. The Manufacturer may announce the cease of production through Manufacturer's sales or service representatives.
- (2) The Manufacturer does not provide any parts or spare parts for the Product after the cease of production.

## 3. Repair services outside Japan

Contact your local FA Center of the Manufacturer for product repair. Repair conditions may differ from one FA Center to another.

## 4. The Manufacturer is not liable for any loss of opportunity or consequential damage

Regardless of the period or scope of warrantee, the Manufacturer shall in no event be liable for or warrant the Product as to any failure due to a cause not attributable to the Manufacturer, any loss of opportunity or profit to the Purchaser due to failure of the Product of the Manufacturer, any damage, consequential damage, compensation for accident, damage to any product or items other than the Manufacturer's Product regardless of whether foreseeable or not by the Manufacturer, or any replacement by the Purchaser, readjustment or retesting or the like of Purchaser's machines or equipment at the site.

## 5. Changes in Product specifications

The specifications or technical data specified in the product catalogs, manuals or technical documents may be subject to change without prior notice.

## 6. Application of Product

- (1) The Manufacturer's Motion Controller and Simple Motion Module shall be used or applied on the condition that any failure or defect of the Motion Controller and the Simple Motion Module will not lead to a serious, critical or fatal accident and that a system of backup or fail-safe functions is provided by the Purchaser outside the equipment and the system works in the event of any failure or defect of the Motion Controller and the Simple Motion Module.
- (2) The Manufacturer's Motion Controllers and Simple Motion Module are for general purposes and designed and manufactured for use in general industry.

The Motion Controllers and the Simple Motion Module therefore shall not be used for any purposes or applications such as a nuclear power plant or other power plant of an electric company in which a failure may greatly affect the public interest, or any purposes or applications such as for railway companies or public offices where a special quality assurance system is required. The Motion Controllers and the Simple Motion Module shall not be used for any purposes or applications such as for aviation equipment, medical equipment, railway equipment, fuel or combustion equipment, manned transfer equipment, amusement machines and safety equipment in which a failure is expected to greatly affect human lives or properties.

For such use or application described above however, the Motion Controllers and the Simple Motion Module may be available if the Purchaser agrees that the Products are used or applied within a specific limit and no special quality is required. Consult the representatives of the Manufacturer.

Mitsubishi Electric Corporation Nagoya Works is a factory certified for ISO14001 (standards for environmental management systems) and ISO9001 (standards for quality assurance management systems)



# Mitsubishi Electric SSCNET III/H compatible Motion Controller Q173DSCPU/Q172DSCPU Simple Motion Module QD77MS16/QD77MS4/QD77MS2

## Safety Warning

To ensure proper use of the products listed in this catalog, please be sure to read the instruction manual prior to use.

Country/Region	Sales office	Tel/Fax
USA	MITSUBISHI ELECTRIC AUTOMATION, INC. 500 Corporate Woods Parkway, Vernon Hills, IL 60061, U.S.A	Tel : +1-847-478-2100 Fax : +1-847-478-2253
Brazil	MELCO-TEC Representacao Comercial e Assessoria Tecnica Ltda. Av. Paulista, 1439, cj74, Bela Vista, Sao Paulo CEP: 01311-200 - SP Brazil	Tel : +55-11-3146-2200 Fax : +55-11-3146-2217
Germany	MITSUBISHI ELECTRIC EUROPE B.V. - German Branch Gothaer Strasse 8, D-40880 Ratingen, Germany	Tel : +49-2102-486-0 Fax : +49-2102-486-1120
UK	MITSUBISHI ELECTRIC EUROPE B.V. UK Branch Travellers Lane, Hatfield, Hertfordshire, AL10 8XB, UK.	Tel : +44-1707-27-6100 Fax : +44-1707-27-8695
Italy	MITSUBISHI ELECTRIC EUROPE B.V. - Italian Branch VIALE COLLEONI 7 - 20041 Agrate Brianza (Milano), Italy	Tel : +39-039-60531 Fax : +39-039-6053-312
Spain	MITSUBISHI ELECTRIC EUROPE, B.V. - Spanish Branch Carretera de Rubí 76-80, E-08190 Sant Cugat del Vallés (Barcelona), Spain	Tel : +34-935-65-3131 Fax : +34-935-89-2948
France	MITSUBISHI ELECTRIC EUROPE B.V. - French Branch 25, Boulevard des Bouvets, F-92741 Nanterre Cedex, France	Tel : +33-1-55-68-55-68 Fax : +33-1-55-68-57-57
Czech Republic	MITSUBISHI ELECTRIC EUROPE B.V. -o.s. Czech office Avenir Business Park, Radicka 714/113a, 158 00 Praha5, Czech Republic	Tel : +420-251-551-470 Fax : +420-251-551-471
Poland	MITSUBISHI ELECTRIC EUROPE B.V. Polish Branch Krakowska 50, 32-083 Balice, Poland	Tel : +48-12-630-47-00 Fax : +48-12-630-47-01
Russia	MITSUBISHI ELECTRIC EUROPE B.V. Russian Branch St.Petersburg office Piskarevsky pr. 2, bld 2, lit "Sch", BC "Benua", office 720; 195027, St.Petersburg, Russia	Tel : +7-812-633-3497 Fax : +7-812-633-3499
South Africa	Circuit Breaker Industries Ltd. 9 Derrick Road, Spartan, Gauteng PO Box 100, Kempton Park 1620, South Africa	Tel : +27-11-977-0770 Fax : +27-11-977-0761
China	MITSUBISHI ELECTRIC AUTOMATION (CHINA) LTD. No.1386 Hongqiao Road, Mitsubishi Electric Automation Center, Changning District, Shanghai, China	Tel : +86-21-2322-3030 Fax : +86-21-2322-3000
Taiwan	SETSUYO ENTERPRISE CO., LTD. 6F., No.105, Wugong 3rd, Wugu Dist, New Taipei City 24889, Taiwan, R.O.C.	Tel : +886-2-2299-2499 Fax : +886-2-2299-2509
Korea	MITSUBISHI ELECTRIC AUTOMATION KOREA CO., LTD. (Sales) 3F, 1480-6, Gayang-Dong, Gangseo-Gu, Seoul, 157-200, Korea	Tel : +82-2-3660-9510 Fax : +82-2-3664-8372/8335
Singapore	MITSUBISHI ELECTRIC ASIA PTE. LTD -Industrial Division 307 Alexandra Road #05-01/02, Mitsubishi Electric Building, Singapore	Tel : +65-6470-2480 Fax : +65-6476-7439
Thailand	MITSUBISHI ELECTRIC AUTOMATION (THAILAND) CO., LTD. Bang-Chan Industrial Estate No.111, Soi Serithai 54, T.Kannayao, A.Kannayao, Bangkok 10230, Thailand	Tel : +66-2906-3238 Fax : +66-2906-3239
Indonesia	P. T. Autoteknindo Sumber Makmur Muara Karang Selatan, Block A / Utara No.1 Kav. No. 11, Kawasan Industri Pergudangan, Jakarta- Utara 14440, P.O.Box 5045, Indonesia	Tel : +62-21-663-0833 Fax : +62-21-663-0832
India	MITSUBISHI ELECTRIC INDIA PVT. LTD. 2nd Floor, Tower A & B, Cyber Greens, DLF Cyber City, DLF Phase-III, Gurgaon - 122 002 Haryana, India	Tel : +91-124-4630300 Fax : +91-124-4630399
Australia	MITSUBISHI ELECTRIC AUSTRALIA PTY. LTD. 348 Victoria Road PO BOX11, Rydalmere, N.S.W 2116, Australia	Tel : +61-2-9684-7777 Fax : +61-2-9684-7245

## MITSUBISHI ELECTRIC CORPORATION

HEAD OFFICE: TOKYO BUILDING, 2-7-3, MARUNOUCHI, CHIYODA-KU, TOKYO 100-8310, JAPAN  
NAGOYA WORKS: 1-14, YADA-MINAMI 5, HIGASHI-KU, NAGOYA, JAPAN