



MITSUBISHI ELECTRIC

MAGNETIC MOTOR STARTERS AND MAGNETIC CONTACTORS

Changes for the Better

MS-Nseries

Performance with a refined new design and functional beauty



Mitsubishi Electric Corporation Nagoya Works is a factory certified for ISO14001 (standards for environmental management systems) and ISO9001 (standards for quality assurance management systems)



(Note)
Mark indicating China Compulsory Certification approval.



(Note)
Mark indicating EC Command compliance. Products with CE Mark can be used in Europe.



TÜV Rheinland
(Note)
Mark indicating TUV Rheinland Group certification.



(Note)
Mark indicating product UL/CSA certification by Underwriter's Laboratory.



Substantial safety and functionality realized with a full lineup

Incorporation of CAN terminal for simple wiring

By adopting a CAN terminal, there is no need to remove the screws, and losing of the terminal screw is prevented by the integrated screw holder and terminal screw. The terminal screw is set in a plastic screw holder. When each pole is moved and the screw loosened, the screw is naturally set in the screw holder. This is Mitsubishi's original CAN terminal. (Patented)
(S-N10CX~N35CX, SD-N11CX~N35CX, SR/SRD-N4CX)

Unified design for N series

The design has been unified for the MS-N series. The front face of the product is a bright white color, making the inside of the panel brighter and providing a clean image.

Arc space reduced to approx. one-third!

By adopting the new extinguishing mechanism, the arc space has been reduced to approx. 1/3 (Mitsubishi comparison).

Compatible with International Standards

Most of Mitsubishi's standard products comply with International Standards.

Applicable standards: JIS, JEM, IEC, EN, VDE, BS

Approved standards: UL, CSA, LR, BV, NK, KR, TÜV, GB



Small-Sized Models S-N10~N35

Simple installation and wiring

The MS-N series contactors, starters and relays can be installed on a mounting rail (35mm width). The terminals of these coils are arranged on the contactor with simple wiring. Furthermore, the distance between the center of the rail and the coil terminals is unified at 38.5mm. (S-N10 to N21, MSO-N10 to N21 and SR-N4)

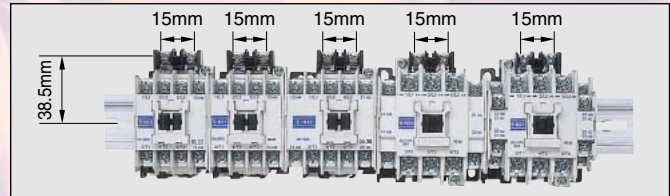

Simple inspections

The contactor can be inspected easily by removing the arc cover.



Built-in surge absorber

The model with built-in surge absorber for coils is obtainable as an option.

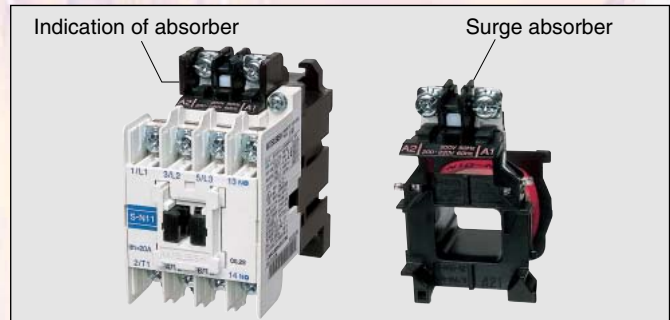

CAN terminal realizes safety and speedy

The models with finger protection are safer and speedier even if the lug of a closed type eyelet (ring) terminal plate is used. (S-N10CX~N35CX, SD-N11CX~N35CX, SR/SRD-N4CX)

Pull up the screw holder. Insert the closed eyelet connector, and push up the screw holder. Tighten the screw.



Stronger barrier strength is improved with the thermoplastic mold.

Improved magnet

By using a spiral kick-out spring, the dynamic balance of the moving parts is improved, bouncing is reduced, and the core life is extended. Furthermore, the core movement is generally stabilized. The efficient magnet has been achieved through modern technology of the magnet section using a computer. The contactor has a performance to withstand a voltage drop to 35% with the closed contact.

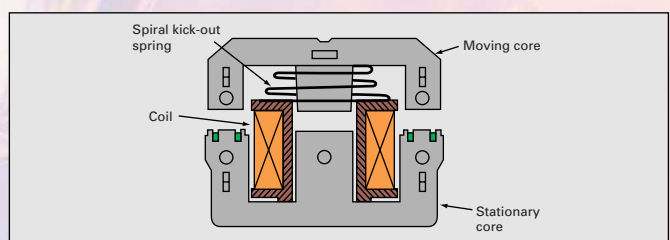

Medium-and Large-Sized Models: S-N50~S-N800

Finger Protection Compatible

An easy-to-install terminal cover, which lays importance on further safety and is compatible with finger protection, has been prepared.

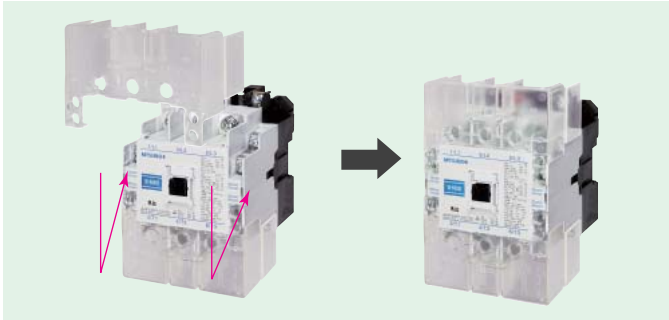

The arc blowoff direction has been changed to further improve safety and space conservation

A new extinguishing structure, which eliminates the blow off of hot gas (arc) to the front (direction to door of control panel) when the current is cutoff has been incorporated.

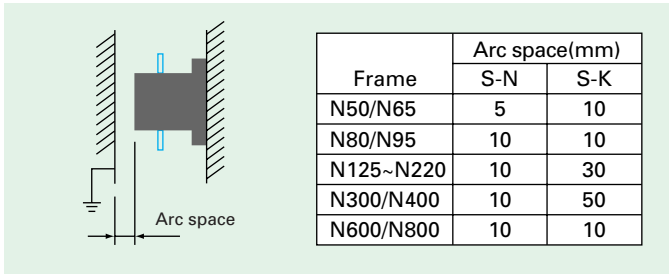

In addition to improved safety, the freedom of panel design has been increased allowing space to be saved.

DC Electromagnet with AC Operation (Patented)

Lower Power Consumption

Coil power consumption is greatly low so MS-N Series contactors can be controlled by almost any type of relay, even small output relays of programmable controllers.

Less Noise nor Surge from Coil

When switching a coil, the energy will be desipated within internal circuit of electromagnet

Humming Completely Eliminated

DC excitation does not cause humming so operation is quiet.

Contactors Coils Have Ultra-Wide Range of Ratings

The voltage rating ranges is widened and the coil type are reduced to one-third.

Internal circuit of the electromagnet

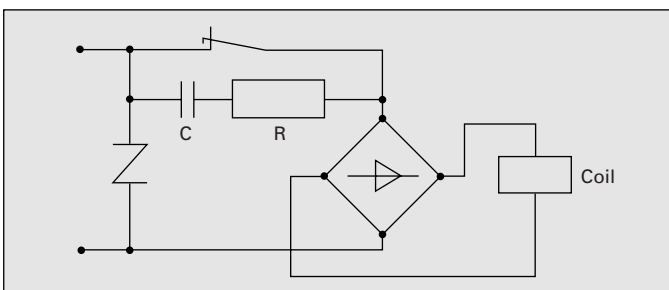

MATCH WITH ELECTRONIC CONTROL FOR FACTORY AUTOMATION

One-touch surge absorber

If the magnetic relay coil is opened and closed near an electronic circuit, malfunctioning of the electronic circuit could be induced by a surge voltage. The UN-SA type surge absorber suppresses the surge voltage when this coil is opened and closed. In



addition to the general varistor type and the CR type that lays importance on suppressing the induction voltage when starting, the type with operating indicator (varistor type), and the varistor type with CR are available.

Auxiliary contact unit with low level contact

This is an auxiliary contact unit with low level contact, capable of opening and closing the low voltage and minute current of the electronic control circuit. It can be installed with one touch onto the magnetic contactor or magnetic relay that opens and closes the power of the motor, etc. The junction relay for opening and closing the low voltage and minute current is not needed, so this unit is suitable for opening and closing electronic input circuits in programmable logic controllers, etc. A compact microswitch is used for the low level contact, so the unit will not malfunction due to fields and surge voltages from the main circuit current and coil of the magnetic contactor.



A 1NO+1NC low level contacts and 1NO+1NC standard contacts are built-in, so the opening and closing of 200VAC and 24VDC can be handled with one unit.

Interface unit

◆2 types of inputs

The long life no-contact output type (UN-SY21, SY31) and contact output type (UN-SY22, SY32) are available.

◆One touch installation

The UN-SY21, SY22, SY31 and SY32 types can be mounted with one touch onto the coil terminal. Post-installation work is easy.



◆Single standalone unit

A single unit installation type (UN-SY11, SY12) is available for the S-KR11 and S-N80 to N400 magnetic contactor.

Direct installation is possible on the following units:

S-N series (Magnetic contactor) 65A frame or less

SR-N series (Magnetic relay) 4-pole, 5-pole and 8-poles types

Even Greater Contact Reliability

Contact reliability has been greatly improved by the bifurcated auxiliary moving contact

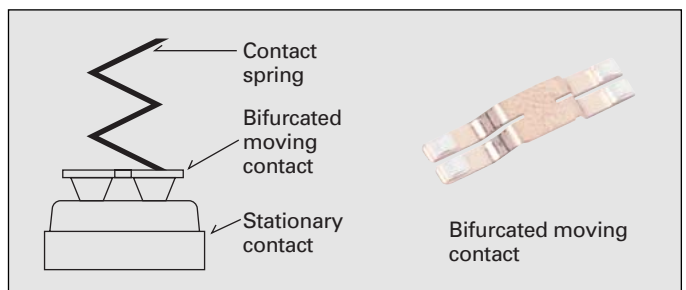

CONTENTS

TYPE REFERENCE LIST	1	
1. GENERAL PURPOSE CONTACTORS & STARTERS	Series MS-N	
1.1 Conformity to International Standards	2	
1.1.1 List of C€ Marked Type	3	
1.1.2 TÜV Certified Type	3	
1.1.3 UL Approval for U.S.A. and Canada	5	
1.1.4 CCC Certified Products	7	
1.1.5 Approved Marine Standards	11	
1.2 Selection Guide	12	
1.3 The Overview (Type designation breakdown)	14	
1.3.1 Non-Reversing Types	14	
1.3.2 Reversing Type	15	
1.4 Technical Data of Series S-N Contactors	16	
1.4.1 Ratings and Characteristics	16	
1.4.2 Performance of Series S-N Contactors	18	
1.4.3 Mounting Attitude of Starters and Contactors	18	
1.5 When Ordering	19	
1.6 Selection Table of Contactors	20	
1.6.1 Non-Reversing Contactors	Type S-N □, SD-N □	20
1.6.2 Reversing Contactors	Type S-2xN □, SD-2xN □	21
1.6.3 Non-Reversing Mechanically Latched Contactors	Type SL-N □, SLD-N □	22
1.6.4 Reversing Mechanically Latched Contactors	Type SL-2xN □, SLD-2xN □, SLxS-N □	23
1.7 Selection Table of Direct-On-Line Motor Starters	24	
1.7.1 Non-Reversing Motor Starters without Enclosure(IP 00) Type MSO-N □	24	
1.7.2 Reversing Motor Starters without Enclosure(IP 00)	Type MSO-2xN □	25
1.7.3 Enclosed Non-Reversing Motor Starters(IP 20)	Type MS-N □	26
1.7.4 Enclosed Non-Reversing Motor Starters with Pushbutton Switch(IP 20)	Type MS-N □ PM	27
1.8 Optional Parts and Accessories for Contactors	28	
1.8.1 Replacement Coils	28	
1.8.2 Replacement Contact Kits	28	
1.8.3 Auxiliary Contact Blocks	29	
1.8.4 Mechanical Interlocks	29	
1.8.5 Connecting Bar Kits	29	
1.8.6 Surge Absorbers	30	
1.8.7 Terminal Covers	30	
1.8.8 Pneumatic Time Delay Modules	30	
1.8.9 DC Interface Modules	30	
1.9 Connections and Contact Arrangement	31	
1.9.1 S, SD-N□	31	
1.9.2 S, SD-2xN□	32	
1.9.3 SL, SLD-(2x)N□	33	
1.9.4 MSO-(2x)N□	34	
1.9.5 MS-N□	35	
1.9.6 MS-N□PM	35	
1.10 Outline Dimensions	36	
1.10.1 Outline Dimensions of Non-Reversing Contactors	36	
1.10.2 Outline Dimensions of Reversing Contactors	37	
1.10.3 Outline Dimensions of Open Type Starters	38	
1.10.4 Outline Dimensions of Enclosed Motor Starters	39	

2. MOTOR PROTECTION RELAYS		
2.1 Thermal Overload Relays	Series TH-N	40
2.1.1 Selection Guide of Thermal Overload Relays		41
2.1.2 Selection Guide of the Current Transformers for TH-N600KP		42
2.1.3 Technical Data		42
2.1.4 Selection Guide of Quick Trip Thermal Overload Relay		42
2.1.5 Operating Characteristics of Thermal Overload Relays		43
(Connecting wire size : Refer to “standard wire size” of Table 2.1.3)		
2.1.6 Optional Parts and Accessories		44
2.1.7 Outline Dimensions		45
2.2 Electronic Motor Protection Relays	Series ET-N	46
3. DEFINITE PURPOSE CONTACTORS & STARTERS		
3.1 DC Contactors	Series DU-K/A	49
3.2 Medium Voltage Vacuum Contactors	Series SH-V	52
3.3 Compact 3-Pole Contactors	Series S-N □ 8	55
3.4 NC Main Contact Contactors	Series B-N	56
3.5 Delay Open Type Magnetic Starters & Contactors	Series S/MSO-N □ DL	58
3.6 DC Interface Contactors	Series SD-Q	60
3.7 DC Interface Modules	Series UN-SY	63
4. RELAYS		
4.1 Contactor Relays	Series SR-N	65
4.1.1 Specifications		66
4.1.2 Auxiliary Contact Blocks		67
4.1.3 Contact Arrangements of Contactor Relay		68
4.1.4 Spare Coils & Accessories		68
4.1.5 Outline Dimensions		68
4.2 Voltage Detection Relays	Series SRE	69
4.3 Re-Starting Relays	Series UA-DL	71
4.4 Solid State Time Delay Relays	Series SRS-H	73
4.5 Pneumatic Time Delay Relays	Series SRT-N	74
5. STAR-DELTA STARTERS	Series EYD-N	
5.1 Selection Table		76
5.2 Specifications		77
5.3 Outline Dimensions		78
5.3.1 Open Type (EYDO-N)		78
5.3.2 Enclosed Type (EYD-N)		78
6. SOLID STATE CONTACTORS	Series US-N/K, H	
6.1 Features		79
6.2 Product Scope		80

TYPE REFERENCE LIST

Type	Description	Ref. Page
B(D)-N <input type="checkbox"/>	NC main contact contactors	56
DU(D)- <input type="checkbox"/>	DC contactors	49
ET-N <input type="checkbox"/>	Electronic motor protection relays	46
EYD(O)-N <input type="checkbox"/>	Star-delta starters	76
MS-N <input type="checkbox"/>	General purpose enclosed type motor starters	26
MS-N <input type="checkbox"/> PM	Enclosed non-reversing motor starters with pushbutton switch	27
MSO(D)-N <input type="checkbox"/>	General purpose open type motor starters	14,24,38
MSO-N <input type="checkbox"/> DL	Delay open type magnetic contactors	58
MSO(D)-2XN <input type="checkbox"/>	General purpose open and reversing type motor starters	15,25,38
PF- <input type="checkbox"/>	Plug-in sockets for,UA-DL2	72
S-N <input type="checkbox"/> 8	Compact 3-pole contactors	55
S(D)-N <input type="checkbox"/>	General purpose contactors	2~
SD-Q <input type="checkbox"/>	DC interface contactors	60
S-N <input type="checkbox"/> DL	Delay open type magnetic contactors	58
S(D)-2XN <input type="checkbox"/>	General purpose reversing contactors	32
SH(L)(D)-V <input type="checkbox"/>	Medium voltage vacuum contactors	52
SH(L)(D)-2XV <input type="checkbox"/>	Medium voltage reversing vacuum contactors	52
SL(D)-N <input type="checkbox"/>	Mechanically latched contactors	22
SL(D)-2XN <input type="checkbox"/>	Mechanically latched reversing contactors	23
SLXS-N <input type="checkbox"/>	Mechanically latched and normal reversing contactors	23
SR(D)-N <input type="checkbox"/>	Contactors relays	65
SRE- <input type="checkbox"/>	Voltage detection relays	69
SRS-H <input type="checkbox"/>	Solid state time delay relays	73
SRT(D)-N <input type="checkbox"/>	Pneumatic time delay relays	74
TH-N <input type="checkbox"/>	Thermal overload relays	40
THR- <input type="checkbox"/>	Saturable reactors for TH-N	44
UA-AXVV <input type="checkbox"/>	Auxiliary contact blocks for SH-V	54
UA-DL2	Re-starting relay	71
UA-SU <input type="checkbox"/>	Surge absorbers for SH-V	53
UN-AX <input type="checkbox"/>	Auxiliary contact blocks	29,50,67
UN-ML <input type="checkbox"/>	Mechanical interlocks for S-N	29
UN-RR <input type="checkbox"/>	Reset release for TH-N	44
UN-SA <input type="checkbox"/>	Surge absorbers for S-N and SR-N4	30
UN-SY <input type="checkbox"/>	DC interface modules for S-N	30,63
UN-TL <input type="checkbox"/>	Trip indicator for TH-N	44
UN-TR <input type="checkbox"/>	Pneumatic time delay modules	30,78
US-N <input type="checkbox"/> /K <input type="checkbox"/>	Solid State Contactors	79
US-H <input type="checkbox"/>	Solid State Contactors	79

1. GENERAL PURPOSE CONTACTORS & STARTERS

Series MS-N

1.1 Conformity to International Standards

Mitsubishi magnetic motor starters and contactors are designed to conform to the relevant IEC recommendations and to the standards of as many countries as possible. Specifically, they conform to the following:

IEC60947-4-1 International
EN60947-4-1 Europe

VDE0660 Germany
NEMA-ICS U.S.A

Table 1.1

Type	Model Name	Europe		North America / UL				China	Marine			
		CE Mark 	TÜV 	Listing 		Recognition 		CCC certification 	U.K. 	France 	Korea 	Japan
				U.S.A. 	Canada 	U.S.A. 	Canada 		Lloyd's Register of Shipping	Bureau Veritas	Korean Register of Shipping	Nippon Kaiji Kyokai
AC Operated Contactor	S-N10(CX)											
	S-N11(CX)/N12(CX)											
	S-N18(CX)											
	S-N20(CX)/N21(CX)											
	S-N25(CX)		⊙ (*2)									
	S-N35(CX)											
	S-N28(CX)											
	S-N38(CX)											
	S-N48(CX)											
	S-N50											
	S-N65	⊙										
	S-N80											
	S-N95											
	S-N125		⊙									
	S-N150											
	S-N180											
S-N220												
S-N300												
S-N400												
S-N600												
S-N800				☆				★				
Overload Relay	TH-N12(CX)KP		⊙ (*2)									
	TH-N18(CX)KP											
	TH-N20(TA)(CX)KP											
	TH-N60(TA)KP	⊙										
	TH-N120(TA)KP		⊙									
	TH-N220RHKP/HZKP											
DC Operated Contactor	SD-N11(CX)/N12(CX)		⊙ (*2)									
	SD-N21(CX)											
	SD-N35(CX)											
	SD-N50											
	SD-N65											
	SD-N80											
	SD-N95	⊙										
	SD-N125		⊙									
	SD-N150											
	SD-N220											
	SD-N300											
	SD-N400											
SD-N600												
SD-N800								★				
AC Operated Contactor Relay	SR-N4(CX)	⊙	● (*2)	⊙	⊙	⊙ (UL Mark)	⊙ (UL Mark)	⊙	⊙	⊙	—	—
DC Operated Contactor Relay	SRD-N4(CX)	⊙	● (*2)	⊙	⊙	⊙ (UL Mark)	⊙ (UL Mark)	⊙	⊙	⊙	—	—
Auxiliary Contact Block	UN-AX2(CX)											
	UN-AX4(CX)											
	UN-AX11(CX)	⊙	⊙ (*2)	⊙	⊙	⊙ (UL Mark)	⊙ (UL Mark)	★	⊙	⊙	—	—
	UN-AX80											
	UN-AX150											

Notes: 1. ⊙ : CE Mark (Manufacturer's Declaration) == Standard model applicable, marking on the product.

UL, TÜV, CCC == Standard model applicable, marking on the product.

NK == Standard model applicable, Certificate No. on the product.

● : Standard model applicable, no marking on the product. If marking required, order model name followed by suffix "DZ".

○ : Standard model applicable, no marking on the product.

☆ : Special model applicable, marking on the product. Order model name followed by suffix "UL".

★ : China export applicable, no marking on the product. Ensure to add "CN" after the model name when placing an order.

— : Not applicable to the Standard or not approved.

2. Finger protection type is certified according to DIN VDE 0106 part 100. For finger protection type, order model name followed by suffix "CX".

3. For each certificate conditions, see next three pages.

1.1.1 List of C Marked Type



Table 1.1.1

Standard Contactors Non-reversing	A.C. operated	S-N10, S-N11, S-N12, S-N18, S-N20, S-N21, S-N25, S-N28, S-N35, S-N38, S-N48, S-N50, S-N65, S-N80, S-N95, S-N125, S-N150, S-N180, S-N220, S-N300, S-N400, S-N600, S-N800
	D.C. operated	SD-N11, SD-N12, SD-N21, SD-N35, SD-N50, SD-N65, SD-N80, SD-N95, SD-N125, SD-N150, SD-N220, SD-N300, SD-N400, SD-N600, SD-N800
Standard Contactors Reversing	A.C. operated	S-2XN10, S-2XN11, S-2XN20, S-2XN21, S-2XN25, S-2XN35, S-2XN50, S-2XN65, S-2XN80, S-2XN95, S-2XN125, S-2XN150, S-2XN180, S-2XN220, S-2XN300, S-2XN400, S-2XN600, S-2XN800
	D.C. operated	SD-2XN11, SD-2XN21, SD-2XN35, SD-2XN50, SD-2XN65, SD-2XN80, SD-2XN95, SD-2XN125, SD-2XN150, SD-2XN220, SD-2XN300, SD-2XN400, SD-2XN600, SD-2XN800
Additional Auxiliary Contact Blocks		UN-AX2, UN-AX4, UN-AX11, UN-AX80, UN-AX150, UQ-AX2(KR)
Mechanical Interlocks ³		UN-ML11, UN-ML21, UN-ML80, UN-ML150, UN-ML220
Thermal Overload Relays		TH-N12KP, TH-N18KP, TH-N20KP, TH-N20TAKP, TH-N60KP, TH-N60TAKP, TH-N120KP, TH-N120TAKP, TH-N220RHKP, TH-N220HZKP, TH-N400RHKP, TH-N400HZKP, TH-N600KP
Contactor Relays	A.C. operated	SR-N4
	D.C. operated	SRD-N4
D.C. Interface Contactors	Non-reversing	SD-Q11, SD-Q12, SD-Q19
	Reversing	SD-QR11, SD-QR12, SD-QR19
Solid state Contactors (for motor/heater load)		US-N5SS(TE), US-N8SS(TE), US-N20(TE), US-N30(TE), US-N40(TE), US-N50(TE), US-N70NS(TE), US-N80NS(TE), US-NH70NS(TE), US-NH80NS(TE), US-N20(TE)CX, US-N30(TE)CX, US-N40(TE)CX, US-N20(TE)RM
Solid state Contactors (for heater load)		US-H20(DD), US-H30(DD), US-H40(DD), US-H50(DD), US-H20(DD)RM, US-H30(DD)RM

Notes: 1. Listed types are representatives and contains standard models.

2. Applicable product standards

Contactors

Thermal overload relays

Aux. contact blocks

Mechanical interlocks

3. For mechanical interlocks, no marking on the product. Mechanical interlocks are applicable when used in reversing contactors.

4. Necessary to connect a varistor etc., in order to provide compliance for CE marking for the US-N5/N8SS(TE) and US-N(H) 70N(H) 80NS(TE) type.

Solid state Contactors : EN60947-4-2, EN60947-4-3

(for motor/heater load)

Solid state Contactors : EN60947-4-3

(for heater load)

1.1.2 TÜV Certified Type

Contactor



TÜV Rheinland

Table 1.1.2 (1)

Model Name	Applicable standard	Certificate No.	Mirror contact ⁵	
			Internal auxiliary NC contact	Auxiliary contact block Auxiliary NC contact
S-N10(CX)(SA) S-N11(CX)(SA) S-N12(CX)(SA)	EN60947-4-1	R9551340	○	○ (UN-AX2(CX), UN-AX4(CX))
S-N20(CX)(SA) S-N21(CX)(SA)	EN60947-4-1	R9551336		
S-N25(CX)(SA) S-N35(CX)(SA)	EN60947-4-1	R9651190		
S-N18(CX)(SA) S-N28(CX)(SA) S-N38(CX)(SA) S-N48(CX)(SA)	EN60947-4-1	R9651189	—	—
S-N50/S-N65	EN60947-4-1	R9851170	○	○ (UN-AX2(CX), UN-AX4(CX))
S-N80/S-N95	EN60947-4-1	R9851138	○	—
S-N125	EN60947-4-1	R9851169	○	—
S-N150	EN60947-4-1	R9851167	○	○ (UN-AX150)
S-N180/S-N220	EN60947-4-1	R9851164	○	○ (UN-AX150)
S-N300/S-N400	EN60947-4-1	R9851171	○	○ (UN-AX150)
SD-N11(CX)(SA) SD-N12(CX)(SA) SD-N21(CX)(SA) SD-N35(CX)(SA)	EN60947-4-1	R9551340 R9551336 R9651190	○	○ (UN-AX2(CX), UN-AX4(CX))
SD-N50/SD-N65	EN60947-4-1	R9851170	○	—
SD-N80/SD-N95	EN60947-4-1	R9851138	○	—
SD-N125	EN60947-4-1	R9851169	○	—
SD-N150	EN60947-4-1	R9851167	○	○ (UN-AX150)
SD-N220	EN60947-4-1	R9851164	○	○ (UN-AX150)
SD-N300/SD-N400	EN60947-4-1	R9851171	○	○ (UN-AX150)

Notes: 1. Standard models are applicable under following conditions.

Main circuits

(Main contacts)

Auxiliary contacts

Operation coil

: AC-3 rated current at 440V AC max.

and rated continuous current.

: AC-15 rated current at 550V AC max.

and rated continuous current.

: AC coil designation

N10~N12, N18~N48 and SR-N4 ; AC12V~AC440V

N20~N35 ; AC12V~AC380V

N50~N150 ; AC24V~AC500V

N180~N400 ; AC48V~AC500V

DC coil designation DC12V~DC220V

2. For contactors, standard models are with TÜV mark on the product.

For other products, standard models are with no TÜV mark on the product.

3. Finger protection type is certified according to DIN VDE 0106 part 100. For finger protection type, order model name followed by suffix "CX".

4. Models with built-in surge absorber (model name followed by "SA") are also certified.

5. Mirror contact function compliance certification has been obtained from TÜV. This product is suitable for use in a machine tool's interlock circuit. The mirror contact function refers to a function in which the auxiliary NC contact can withstand a 2500V impulse voltage without contacting even if the main contact melts. 3

DC Interface Contactor

Table 1.1.2 (2)

Model Name	Certificate No.	Miller contact ⁵	
		Internal auxiliary NC contact	Auxiliary contact block Auxiliary NC contact
SD-Q11	R2-50004919	○ ⁶	○ (UQ-AX2)
SD-Q12	R2-50004919	○	—
SD-Q19	R2-50004918	○	—
SD-QR11	R2-50004919	—	—
SD-QR12	R2-50004919	—	—
SD-QR19	R2-50004918	—	—

Contacting Relay

Table 1.1.2 (4)

Model Name	Applicable standard	Certificate No.
SR-N4(CX)(SA)	EN60947-5-1	R9551339
SRD-N4(CX)(SA)	EN60947-5-1	R9551339

Thermal Overload Relay

Table 1.1.2 (3)

Model Name	Applicable standard	Registration No.
TH-N12(CX)KP	EN60947-4-1	J9551338
TH-N18(CX)KP	EN60947-4-1	J9551338
TH-N20(TA)(CX)KP	EN60947-4-1	J9551341
TH-N60(TA)KP	EN60947-4-1	J9851140
TH-N120(TA)KP	EN60947-4-1	J9851168
TH-N220RHKP/HZKP	EN60947-4-1	J9851166
TH-N400RHKP/HZKP	EN60947-4-1	J9851172

Auxiliary Contact Block

Table 1.1.2 (5)

Model Name	Applicable standard	Registration No.
UN-AX2(CX)	EN60947-5-1	J9551337
UN-AX4(CX)		
UN-AX11(CX)		
UN-AX80	EN60947-5-1	R9851225
UN-AX150		

Notes: 1. Standard models are applicable under following conditions.

- Main circuits (Main contacts) : AC-3 rated current at 440V AC max. and rated continuous current.
 Auxiliary contacts : AC-15 rated current at 550V AC max. (SD-Q(R)11~Q(R)19 : 440V AC max.) and rated continuous current.
 Operation coil : AC coil designation
 SR-N4 ; AC12V~AC440V
 DC coil designation DC12V~DC220V (SD-Q(R)11~Q(R)19 : DC12V~DC24V)

2. For contactors, standard models are with TÜV mark on the product.
 For other products, standard models are with no TÜV mark on the product.
 For contactor relays, order model name followed by suffix "DZ" if TÜV mark on the product is required.
 3. Finger protection type is certified according to DIN VDE 0106 part 100. For finger protection type, order model name followed by suffix "CX".
 4. Models with built-in surge absorber (model name followed by "SA") are also certified.
 5. Miller contact function compliance certification has been obtained from TÜV. This product is suitable for use in a machine tool's interlock circuit. The miller contact function refers to a function in which the auxiliary NC contact can withstand a 2500V impulse voltage without contacting even if the main contact melts.
 6. If the SD-Q11 with INC is required, it must be so indicated when placing an order.

Solid state contactor (for motor/heater load)

Table 1.1.2 (6)

Model Name	Approval rating (A)						Certificate No.			Applicable standard
	Heater (AC-51)				Motor (AC-53)		Standard	Finger protected	Mounting on 35mm rail	
	AC100-240V		AC200-440V		AC200-240V	AC400-440V				
	40C°	60C°	40C°	60C°	40C°	40C°	US-□	US-□CX	US-□RM	
US-N5SS(TE)	5	3	—	—	3.2	—	R50037627	—	—	
US-N8SS(TE)	8	4.8	—	—	3.2	—				
US-N20(TE)	20	12	20	12	11.1	11.1	R50037628	R50037628	R50037628	
US-N30(TE)	30	18	30	18	17.4	17.4				
US-N40(TE)	40	24	40	24	26	26				
US-N50(TE)	50(45)	30(27)	50(45)	30(27)	26	26				
US-N70NS(TE)	70	42	—	—	48	—				
US-N80NS(TE)	80	48	—	—	48	—	R50037629	—	—	
US-NH70NS(TE)	—	—	65	39	48	48				
US-NH80NS(TE)	—	—	75	45	48	48	R50037630	—	—	

- Notes: 1. The number in the type field indicates the certificate number, and hyphen "-" indicates that there are no compatible models.
 2. The value in the certified rating field in the bracket "()" indicates the rating for US-N50TE.
 3. The frame field "(TE)" indicates 3-pole, 3-element type main circuit.
 4. Standard models are with TÜV mark on the product.

Solid state contactor (for heater load)

Table 1.1.2 (7)

Model Name	Approval rating (A)		Certificate No.			Applicable standard
	Heater (AC-51)		Standard	No cooling fin	Mounting on 35mm rail	
	AC24-480V					
	40C°	60C°	US-□	US-□HZ	US-□RM	
US-H20(DD)	20	12	R50018958	R50018958	R50018958	
US-H30(DD)	30	18				
US-H40(DD)	40	24				
US-H50(DD)	50	30				

- Notes: 1. The number in the type field indicates the certificate number, and hyphen "-" indicates that there are no compatible models.
 2. The frame field "(DD)" indicates 3-pole individual control.
 3. Standard models are with TÜV mark on the product.

1.1.3 UL Approval for U.S.A. and Canada



■ Contactor and Motor Starter

Table 1.1.3 (1)

Mark	c UL US																		c UL US	
	Model Name	S-N10(CX)	S/D-N11(CX) S/D-N12(CX)	S-N18(CX)	S-N20(CX) S/D-N21(CX)	S-N25(CX)	S/D-N35(CX)	S(D)-N50	S(D)-N65	S(D)-N80	S(D)-N95 ²	S(D)-N125 ²	S(D)-N150 ²	S-N180 ²	S(D)-N220 ²	S(D)-N300 ²	S(D)-N400 ²	S-N600 ²		S-N800UR ²
Contactor (open)	Continuous current rating A open	13	20	30	30	35	40	80	95	100	100	125	150	220	220	300	400	680	910	
	Horsepower rating																			
	Single phase	120V HP 240V HP	1/2 1-1/2	1/2 1-1/2	1 3	1 3	2 3	2 5	3 7-1/2	3 10	5 15	7-1/2 15	10 20	15 25	15 30	15 40	— —	— —	— —	— —
	Three phase	208V HP 240V HP 480V HP 600V HP	3 3 5 5	3 3 7-1/2 7-1/2	5 5 10 10	5 5 10 10	7-1/2 7-1/2 15 15	10 10 20 20	15 15 30 30	15 20 40 40	20 25 50 50	25 30 60 60	40 40 75 75	40 50 100 100	60 60 125 125	60 75 150 150	100 100 200 200	125 150 300 300	150 200 400 400	250 300 600 600
Starter (open)	Mark	c UL US																		—
	Model Name	MSO-N10KP(CX)	MSO-N11KP(CX) N12KP(CX)	MSO-N18KP(CX)	MSO-N20KP(CX) N21KP(CX)	MSO-N25KP(CX)	MSO-N35KP(CX)	MSO-N50KP	MSO-N65KP	MSO-N80KP	MSO-N95KP ²	MSO-N125KP ²	MSO-N150KP ²	MSO-N180KP ²	MSO-N220KP ²	MSO-N300KP ²	MSO-N400KP ²	—	—	
	Horsepower rating																			
	Three phase	208V HP 240V HP 480V HP 600V HP	3 3 5 5	3 3 7-1/2 7-1/2	5 5 10 10	5 5 10 10	7-1/2 7-1/2 15 15	10 10 20 20	15 15 30 30	15 20 40 40	20 25 50 50	25 30 60 60	40 40 75 75	40 50 100 100	60 60 125 125	60 75 150 150	100 100 200 200	125 150 300 300	150 200 400 400	— — — —
Max. rating of short circuit protection device																				
Fuse class K5	A	30	30	70	70	100	125	250	250	300	225	350	350	500	500	600 ³	500 ³	800 ⁴	1200 ⁴	
Circuit breaker	A	—	—	—	—	100	125	—	—	300	225	350	350	500	500	600	1000	—	—	

- Notes: 1. UL listed types for S-N600 and S-N800 require suffix letters "UL" (eg. S-N800UL).
 2. Types S-N95 to S-N800 and MSO-N95KP to N400KP with Ilco lugs are also listed as type name with suffix letters "UL" (eg. S-N95UL).
 3. Time delay fuse
 4. Class L fuse

■ Thermal Overload Relay



Table 1.1.3 (2)

Model Name	Heater designation (Rated current [A])	Contactor to be coupled	Auxiliary Contact
TH-N12(CX)KP☆	0.12A(0.1~0.16),0.17(0.14~0.22),0.24A(0.2~0.32),	S-N10 S-N11 S-N12	Rated Code / C600 AC600Vmax Make 1800VA(15A max) Break 180VA(1.5A max)
TH-N12(CX)☆*1	0.35A(0.28~0.42),0.5A(0.4~0.6),0.7A(0.55~0.85),0.9A(0.7~1.1),		
TH-N12(CX)HZKP★*2	1.3A(1~1.6),1.7A(1.4~2),2.1A(1.7~2.5),2.5A(2~3),3.6A(2.8~4.4),		
TH-N12(CX)HZ★*1	5A(4~6),6.6A(5.2~8),9A(7~11),11A(9~13)		
TH-N18(CX)KP☆	1.3A(1~1.6),1.7(1.4~2),2.1A(1.7~2.5),2.5A(2~3),3.6A(2.8~4.4),	S-N18	Break 180VA(1.5A max)
TH-N18(CX)☆*1	5A(4~6),6.6A(5.2~8),9A(7~11),11A(9~13),15A(12~18)		
TH-N20(CX)KP	0.24A(0.2~0.32),0.35A(0.28~0.42),0.5A(0.4~0.6),	S-N20 S-N21 S-N25 S-N35	
TH-N20(CX)☆*1	0.7A(0.55~0.85),0.9A(0.7~1.1),1.3A(1~1.6),1.7A(1.4~2),		
TH-N20CXHZKP★	2.1A(1.7~2.5),2.5A(2~3),3.6A(2.8~4.4),5A(4~6),6.6A(5.2~8),		
TH-N20CXHZ★*1	9A(7~11),11A(9~13),15A(12~18)		
TH-N20TAKP☆	22A(18~26)	S-N25,N35	
TH-N20TA☆*1	29A(24~34)	S-N35	
TH-N60KP	15A(12~18),22A(18~26),29A(24~34),35A(30~40),42A(34~50)	S-N50,N65,N80,N95	Rated Code / B600 AC600Vmax Make 3600VA(30A max) Break 360VA(3A max)
	54A(43~65)	S-N65,N80,N95	
TH-N60TAKP☆	67A(54~80) 82A(65~100)	S-N80,N95 S-N95	
TH-N120KP	42A(34~50),54A(43~65),67A(54~80),82A(65~100)	S-N125,N150	Break 360VA(3A max)
TH-N120TAKP☆	105A(85~125) 125A(100~150)	S-N125,N150 S-N150	
TH-N220RHKP☆	82A(65~100),105A(85~125),125A(100~150),150A(120~180)	S-N180,N220	
TH-N220HZKP★	180A(140~220)	S-N220	
TH-N400RHKP☆	105A(85~125),125A(100~150),150A(120~180),180A(140~220),250A(200~300)	S-N300,N400	
TH-N400HZKP★	330A(260~400)	S-N400	

- Notes: 1. ☆ is to be coupled with contactor and can not be mounted separately from contactor. ★ is only for separate mounting.
 2. Suffix "KP" ; Overload and phase failure protection type with three heater elements.
 3. *1 ; TH-N12(CX), N12(CX)HZ, N18(CX), N20(CX), N20CXHZ and N20TA are recognized (UL) for single phase motors.
 4. *2 is to be coupled with TH-N12(CX)KP (c UL US) and UN-HZ12(UL).

■ Contactor Relay and Auxiliary Contact Block

Table 1.1.3 (3)

Type	Model Name	Rated Code;	Rated Code;	Mark
Contactor Relay	SR-N4 SRD-N4	A600	R300	UL, UL
Auxiliary Contact Block	UN-AX2(CX) UN-AX4(CX) UN-AX11(CX)	AC600V max Make 7200VA Break 720VA	DC250V max Make 28VA Break 28VA	UL, UL
	UN-AX80			
	UN-AX150			UL

■ DC Interface Contactor

Table 1.1.3 (4)

Model Name		Horsepower rating [HP]					Continuous current rating [A]
		Single-phase (only non-reversing type)		three-phase			
Non-reversing type	Reversing type	110 ~ 120V	220 ~ 240V	200 ~ 208V	220 ~ 240V	440 ~ 480V	
SD-Q11	SD-QR11	$\frac{1}{3}$	1	3	3	5	20
SD-Q12	SD-QR12						13
MSOD-Q11(KP)	MSOD-QR11KP	$\frac{1}{2}$	$1\frac{1}{2}$	5	5	$7\frac{1}{2}$	30
MSOD-Q12(KP)	MSOD-QR12KP						18
SD-Q19	SD-QR19						
MSOD-Q19(KP)	MSOD-QR19KP						

Note: 1. MSOD-Q11, Q12 and Q19 are approved for single-phase circuits.

■ Solid state contactor (for motor/heater load)

Table 1.1.3 (5)

Model Name		Horsepower rating [HP]				Continuous current rating [A]
		Single-phase		three-phase		
3-pole,2-element type	3-pole,3-element type	100~120V	220~240V	220~240V	440~480V	
US-N5SS	US-N5SSTE	$\frac{1}{10}$	$\frac{1}{4}$	$\frac{3}{4}$	—	5
US-N8SS	US-N8SSTE	$\frac{1}{10}$	$\frac{1}{4}$	$\frac{3}{4}$	—	8
US-N20(CX)(RM)	US-N20TE(CX)(RM)	$\frac{1}{2}$	$1\frac{1}{2}$	3	5	20
US-N30(CX)	US-N30TE(CX)	1	3	5	10	30
US-N40(CX)	US-N40TE(CX)	2	3	$7\frac{1}{2}$	20	40
US-N50(CX)	US-N50TE(CX)	2	3	$7\frac{1}{2}$	20	50
US-N70NS	US-N70NSTE	3	$7\frac{1}{2}$	15	—	70
US-N80NS	US-N80NSTE	3	$7\frac{1}{2}$	15	—	80
US-NH70NS	US-NH70NSTE	3	$7\frac{1}{2}$	15	30	70
US-NH80NS	US-NH80NSTE	3	$7\frac{1}{2}$	15	30	80

■ Solid state contactor (for heater load)

Table 1.1.3 (6)

Model Name		Continuous current rating [A]
Batch control	Individual control	
US-H20(RM)(HZ)	US-H20DD(RM)(HZ)	20
US-H30(RM)	US-H30DD(RM)	30
US-H40	US-H40DD	40
US-H50	US-H50DD	50

Notes: 1. "(HZ)" has no cooling fin. "(RM)" is available rail mounting.

2. The US-H□ (DD) HZ type is certified at the continuous current rating when combined with the fin used on the US-H□ (DD) type.

3. The US-H□ (DD) HZ type is UR certified.

1.1.4 CCC Certified Products

Magnetic motor starters, etc., are designated as products targeted for China Compulsory Certification. CCC certification must be acquired before the product is exported to main land China from Domestic or marketed in China. The certified models are shown in Tables 1.1.4 (1-1) to 1.1.4 (8-2). The option units (UN-CV, ML, RR, SA, etc.) which are mounted on the magnetic motor starter and which do not have a load switching function are excluded from the CCC certification target.



Magnetic motor starter

With Enclosure

Table 1.1.4 (1-1)

Model Name MS : AC operated	Approval rating AC-3 Class (200~240V/380~440V)		Heater designation	Coil designation AC operated	Type ** application range (combination possible)	Number of aux. contacts Non-reversing Standard (special)	Certificate No.
	Rated capacity (kW)	Rated operational current (A)					
MS-N10CN**	2.5/4	11/9	0.12~9A	AC12V~AC500V	KP, SA, PM	1NO	20030103 04093078
MS-N11CN**	3.5/5.5	13/12	0.12~11A			1NO	
MS-N12CN**	3.5/5.5	13/12	0.12~11A			1NO1NC(2NO)	
MS-N20CN**	5.5/11	22/22	0.24~19A	AC12V~AC500V	KP, SA, PM	1NO1NC(2NO)	20030103 04093077
MS-N21CN**	5.5/11	22/22	0.24~19A			2NO2NC	
MS-N25CN**	7.5/15	30/30	0.24~22A			2NO2NC	
MS-N35CN**	11/18.5	40/40	0.24~35A	AC24V~AC500V	PM	2NO2NC	20030103 04093076
MS-N50CNKP**	15/22	55/50	15~54A			2NO2NC	
MS-N65CNKP**	18.5/30	65/65	15~54A			2NO2NC	
MS-N80CNKP**	22/45	85/85	15~67A	AC24V~AC500V	PM	2NO2NC	20030103 04093073
MS-N95CNKP**	30/55	105/105	15~95A			2NO2NC	
MS-N125CNKP	37/60	125/120	42~105A			2NO2NC	
MS-N150CNKP	45/75	150/150	42~125A	AC48V~AC500V	-	2NO2NC	20030103 04093067
MS-N180CNKP	55/90	180/180	82~150A			2NO2NC	
MS-N220CNKP	75/132	250/250	82~210A			2NO2NC	
MS-N300CNKP	90/160	300/300	105~250A	AC48V~AC500V	-	2NO2NC	20030103 04093070
MS-N400CNKP	125/220	400/400	105~330A			2NO2NC	
MS-N400CNKP	125/220	400/400	105~330A			2NO2NC	

Without Enclosure

Table 1.1.4 (1-2)

Model Name MSO : AC operated MSOD : DC operated 2X : Reversing type	Approval rating AC-3 Class (200~240V/380~440V)		Heater designation	Coil designation AC operated (MSO type) DC operated (MSOD type)	Type ** application range (combination possible)	Number of aux. contacts Non-reversing Standard (special)	Certificate No.
	Rated capacity (kW)	Rated operational current (A)					
MSO-(2X)N10**	2.5/4	11/9	0.12-9A	AC12V~AC500V	CX, KP, SA, SR	1NO(1NC)	20020103 04093078
MSO(D)-(2X)N11**	3.5/5.5	13/12	0.12-11A			1NO(1NC)	
MSO(D)-N12**	3.5/5.5	13/12	0.12-11A			1NO1NC(2NO)	
MSO-(2X)N18**	4.5/7.5	18/16	0.12-15A	DC12V~DC220V	CX, SA	-	20020103 04093077
MSO-(2X)N20**	5.5/11	22/22	0.24-19A			1NO1NC(2NO)	
MSO(D)-(2X)N21**	5.5/11	22/22	0.24-19A			2NO2NC	
MSO-(2X)N25**	7.5/15	30/30	0.24-22A	AC24V~AC500V	CX, KP, SA, SR	2NO2NC	20020103 04093076
MSO(D)-(2X)N35**	11/18.5	40/40	0.24-35A			2NO2NC	
MSO(D)-(2X)N50KP**	15/22	55/50	15-42A			2NO2NC	
MSO(D)-(2X)N65KP**	18.5/30	65/65	15-54A	AC24V~AC500V	CX, SR	2NO2NC	20020103 04093073
MSO(D)-(2X)N80KP**	22/45	85/85	15-67A			2NO2NC	
MSO(D)-(2X)N95KP**	30/55	105/105	15-95A			2NO2NC	
MSO(D)-(2X)N125KP**	37/60	125/120	42-105A	DC12V~DC220V	CX, SR	2NO2NC	20020103 04093064
MSO(D)-(2X)N150KP**	45/75	150/150	42-125A			2NO2NC	
MSO-(2X)N180KP**	55/90	180/180	82-150A			2NO2NC	
MSO(D)-(2X)N220KP**	75/132	250/250	82-210A	AC48V~AC500V	SR	2NO2NC	20020103 04093067
MSO(D)-(2X)N300KP**	90/160	300/300	105-250A			2NO2NC	
MSO(D)-(2X)N400KP**	125/220	400/400	105-330A			2NO2NC	
MSO(D)-(2X)N400KP**	125/220	400/400	105-330A	DC12V~DC220V	SR	2NO2NC	20020103 04093070
MSO(D)-(2X)N400KP**	125/220	400/400	105-330A			2NO2NC	
MSO(D)-(2X)N400KP**	125/220	400/400	105-330A			2NO2NC	

Notes: 1. The MSO-(2X)N10KP, MSO(D)-(2X)N11KP or MSO(D)-N12KP type with heater designation 0.12A and 0.17A are not certified.
2. MSO-(2X)N18KP type is not certified.

Magnetic Contactors

General Type Contactors

Table 1.1.4 (2-1)

Model Name S : AC operated SD : DC operated 2X : Reversing type	Approval rating AC-3 Class (200~240V/380~440V)		Conventional free air thermal current lth (A)	Coil designation AC operated (S type) DC operated (SD type)	Type ** application range (combination possible)	Number of aux. contacts Non-reversing Standard (special)	Certificate No.		
	Rated capacity (kW)	Rated operational current (A)							
S-(2X)N10**	2.5/4	11/9	20	AC12V~AC500V DC12V~DC220V	CX, SA	1NO (1NC)	20020103 04023375		
S(D)-(2X)N11**	3.5/5.5	13/12	20			1NO (1NC)			
S(D)-N12**	3.5/5.5	13/12	20			1NO1NC(2NO)			
S-(2X)N18**	4.5/7.5	18/16	25			—	20020103 04023377		
S-(2X)N20**	5.5/11	22/22	32			1NO1NC (2NO)			
S(D)-(2X)N21**	5.5/11	22/22	32			2NO2NC			
S-(2X)N25**	7.5/15	30/30	50			2NO2NC			
S(D)-(2X)N35**	11/18.5	40/40	60			AC24V~AC500V DC12V~DC220V	CX	2NO2NC	20020103 04024704
S(D)-(2X)N50**	15/22	55/50	80					2NO2NC	
S(D)-(2X)N65**	18.5/30	65/65	100					2NO2NC	20020103 04024705
S(D)-(2X)N80	22/45	85/85	135					2NO2NC	
S(D)-(2X)N95	30/55	105/105	150					2NO2NC	20020103 04024706
S(D)-(2X)N125	37/60	125/120	150					2NO2NC	20020103 04024707
S(D)-(2X)N150	45/75	150/150	200					2NO2NC	20020103 04024708
S-(2X)N180	55/90	180/180	260	2NO2NC					
S(D)-(2X)N220	75/132	250/250	260	AC48V~AC500V DC12V~DC220V	—			2NO2NC	20020103 04024709
S(D)-(2X)N300	90/160	300/300	350					2NO2NC	
S(D)-(2X)N400	125/220	400/400	450			2NO2NC			
S(D)-(2X)N600CN	190/330	630/630	660			AC100V~AC500V DC24V~DC220V	—	2NO2NC	20030103 04095569
S(D)-(2X)N800CN	220/440	800/800	800	2NO2NC					

Mechanically Latched Contactors

Table 1.1.4 (2-2)

Model Name SL : AC operated SLD : DC operated 2X : Reversing type	Approval rating AC-3 Class (200~240V/380~440V)		Conventional free air thermal current lth (A)	Coil designation AC operated (SL type) DC operated (SLD type)	Type ** application range (combination possible)	Number of aux. contacts Non-reversing Standard	Certificate No.	
	Rated capacity (kW)	Rated operational current (A)						
SL(D)-(2X)N21**	5.5/11	22/22	32	AC100V~AC500V DC12V~DC200V	CX, SA	2NO2NC	20020103 04023377	
SL(D)-(2X)N35**	11/18.5	40/40	60			2NO2NC		
SL(D)-(2X)N50**	15/22	55/50	80			CX	2NO2NC	20020103 04024704
SL(D)-(2X)N65**	18.5/30	65/65	100				2NO2NC	
SL(D)-(2X)N80	22/45	85/85	135		—	2NO2NC	20020103 04024705	
SL(D)-(2X)N95	30/55	105/105	150			2NO2NC		
SL(D)-(2X)N125	37/60	125/120	150			2NO2NC	20020103 04024706	
SL(D)-(2X)N150	45/75	150/150	200			2NO2NC	20020103 04024707	
SL(D)-(2X)N220	75/132	250/250	260			2NO2NC	20020103 04024708	
SL(D)-(2X)N300	90/160	300/300	350			2NO2NC	20020103 04024709	
SL(D)-(2X)N400	125/220	400/400	450		2NO2NC			
SL(D)-(2X)N600CN	190/330	630/630	660		AC100V~AC500V DC24V~DC200V	—	1NO2NC	20030103 04095569
SL(D)-(2X)N800CN	220/440	800/800	800					

3-Pole Contactors

Table 1.1.4 (2-3)

Model Name S : AC operated 2X : Reversing type	Approval rating AC-3 Class (200~240V/380~440V)		Conventional free air thermal current lth (A)	Coil designation AC operated (S type)	Type ** application range (combination possible)	Number of aux. contacts Non-reversing Standard	Certificate No.
	Rated capacity (kW)	Rated operational current (A)					
S-(2X)N18**	4.5/7.5	18/16	25	AC12V~AC500V	CX, SA	—	20020103 04023377
S-(2X)N28**	7.5/7.5	26/17	30			—	
S-(2X)N38**	11/15	39/32	60			—	
S-(2X)N48**	15/18.5	50/40	80			—	20020103 04024684

NC Main Contact Type Contactors

Table 1.1.4 (2-4)

Model Name B : AC operated BD : DC operated	Main contact Arrangement	Certification ratings (A)			Conventional free air thermal current lth (A)	Coil designation AC operated (B type) DC operated (BD type)	Type ** application range (combination possible)	Number of aux. contacts Non-reversing	Certificate No.
		Number of series	DC-3,5 NC	DC-1 NC					
B(D)-N20CN**	B: 1NO2NC, 3NC	DC110V 2P	8	15	25	AC12V~AC500V	SA	2NO	20020103 04023377
		3P	15	20					
		DC220V 2P	1	5					
B(D)-N65CN	BD: 1NO2NC	3P	5	10	80	AC24V~AC500V DC12V~DC220V	—	2NO2NC	20020103 04024705
		DC110V 2P	20	30					
		3P	50	65					
B(D)-N100CN	B:1NO2NC BD:1NO2NC	DC220V 2P	3	10	120	—	2NO2NC	20020103 04024706	
		3P	20	30					
		DC110V 2P	30	40					

■ Thermal overload relay

● Three heater type with phase failure protection

Table 1.1.4 (3-1)

Model Name	Heater designation	Type ** application range (combination possible)	Combination magnetic contactor	Certificate No.
TH-N12KP**	0.24A, 0.35A, 0.5A, 0.7A, 0.9A, 1.3A, 1.7A, 2.1A, 2.5A, 3.6A, 5A, 6.6A, 9A, 11A	CX, HZ	S-N10~N12	20020103 09024710
TH-N20KP**	0.24A, 0.35A, 0.5A, 0.7A, 0.9A, 1.3A, 1.7A, 2.1A, 2.5A, 3.6A, 5A, 6.6A, 9A, 11A, 15A	CX, HZ, SR	S-N20~N35	20020103 09024712
TH-N20TAKP**	22A, 29A	CX, SR	S-N25, N35	
TH-N60KP**	15A, 22A, 29A, 35A, 42A, 54A	CX, SR	S-N50~N95	20020103 09024714
TH-N60TAKP**	67A, 82A	SR	S-N80, N95	
TH-N120KP**	42A, 54A, 67A, 82A	HZ, SR	S-N125, N150	20020103 09024724
TH-N120TAKP**	105A, 125A	SR		
TH-N220RHKP**	82A, 105A, 125A, 150A, 180A, 210A ²	SR	S-N180, N220	20020103 09024719
TH-N220HZKP**			Dedicated for independent mounting	
TH-N400RHKP**	105A, 125A, 150A, 180A, 250A, 330A		S-N300, N400	
TH-N400HZKP**			Dedicated for independent mounting	
TH-N600KP**	250A, 330A, 500A, 660A		Dedicated for independent mounting	20030103 04095454

Note: 1. The TH-N12KP** type with heater designation 0.12A and 0.17A, and the TH-N18KP** type are not certified.

2. Heater designation 210A are certified for S-N220 type.

● Two heater type

Table 1.1.4 (3-2)

Model Name	Heater designation	Type ** application range (combination possible)	Combination magnetic contactor	Certificate No.
TH-N12**	0.12A, 0.17A, 0.24A, 0.35A, 0.5A, 0.7A, 0.9A, 1.3A, 1.7A, 2.1A, 2.5A, 3.6A, 5A, 6.6A, 9A, 11A	CX, HZ, SR	S-N10~N12	20020103 09024701
TH-N18**	1.3A, 1.7A, 2.1A, 2.5A, 3.6A, 5A, 6.6A, 9A, 11A, 15A	CX, DM	S-N18	20020103 09024702
TH-N20**	0.24A, 0.35A, 0.5A, 0.7A, 0.9A, 1.3A, 1.7A, 2.1A, 2.5A, 3.6A, 5A, 6.6A, 9A, 11A, 15A	CX, HZ, SR	S-N20~N35	20020103 09024703
TH-N20TA**	22A, 29A, 35A ¹	CX, SR	S-N25, N35	

Note: 1. Heater designation 35A are certified for S-N35 type.

■ Auxiliary contact block

Table 1.1.4 (4)

Model Name	Available contact arrangements	Type ** application range (combination possible)	Applicable magnetic contactor	Certificate No.
UN-AX2CN**	2NO, 1NO1NC	CX	S-N10~N65	20020103 03024700
UN-AX4CN**	4NO, 3NO1NC, 2NO2NC		S-N10, N11, N20~N65	
UN-AX11CN**	1NO1NC			
UN-AX80CN	1NO1NC	-	S-N80~N125	20020103 03024720
UN-AX150CN	1NO1NC		S-N150~N400	20020103 03024722
UN-AX600CN	2NO2NC			
UN-LL22CN**	1NO1NC(low level), 1NO1NC(standard)		CX	S-N10~N65, SR-N4

■ DC interface contactor

● Magnetic motor starter

Table 1.1.4 (5-1)

Model Name Q : Non-reversing type QR : Reversing type	Approval rating AC-3 Class (200~240V/380~440V)		Heater designation	Coil designation	Type ** application range (combination possible)	Number of aux. contacts Standard (special)	Certificate No.
	Rated capacity (kW)	Rated operational current (A)					
MSOD-Q11**	3/4	12/9	0.12~11A	DC24V	CX, KP	1NO(1NC)	20030103 04093069
MSOD-Q12**						1NO1NC(2NO)	
MSOD-Q19**	4.5/5.5	18/13	1.3~15A		CX	1NO1NC(2NO)	20030103 04093080
MSOD-QR11**	3/4	12/9	0.12~11A		DC24V	CX, KP	2NC
MSOD-QR12**				2NO2NC			
MSOD-QR19**	4.5/5.5	18/13	1.3~15A		CX	2NO2NC	20030103 04093080

Note: 1. Heater designation 0.12A and 0.17A are not certified for MSOD-Q11KP and Q12KP types.

● Magnetic contactor

Table 1.1.4 (5-2)

Model Name Q : Non-reversing type QR : Reversing type	Approval rating AC-3 Class (200~240V/380~440V)		Conventional free air thermal current Ith (A)	Coil designation	Number of aux. contacts Standard (special)	Certificate No.
	Rated capacity (kW)	Rated operational current (A)				
SD-Q11	3/4	12/9	20	DC24V	1NO(1NC)	20030103 04095567
SD-Q12					1NO1NC(2NO)	
SD-Q19	4.5/5.5	18/13	30		1NO1NC(2NO)	20030103 04086213
SD-QR11	3/4	12/9	20	DC24V	2NC	20030103 04095567
SD-QR12					2NO2NC	
SD-QR19	4.5/5.5	18/13	30		2NO2NC	20030103 04086213

■ Contactor Relays

Table 1.1.4 (6)

Model Name SR : AC operated SRD : DC operated SRL : AC operated SRLD : DC operated	Coil designation	Type ** application range (combination possible)	Available contact arrangement	Certificate No.
	AC operated (SR, SRL type) DC operated (SRD, SRLD type)			
SR-N4**	AC12V-AC440V	CX, SA	4NO, 3NO1NC, 2NO2NC	20020103 03024696
SRD-N4**	DC12V-DC220V			
SRL-N4**	AC100V-AC440V			
SRLD-N4**	DC12V-DC200V			

■ Pneumatic Time Delay Relays

Table 1.1.4 (7)

Model Name SRT : AC operated SRTD : DC operated	Coil designation	Type ** application range (combination possible)	Available contact arrangement	Certificate No.
	AC operated (SRT type) DC operated (SRTD type)			
SRT(D)-NNCN**	AC12V-AC440V	CX, SA	Instantaneous : 2NO2NC	20050103 03152666
SRT(D)-NFCN**	DC12V-DC220V		Delayed : 1NO1NC	

■ Solid State Contactors

• 2-elements type

Table 1.1.4 (8-1)

Model Name	Approval rating AC-51 class (A)	3-ph Heater capacity 220/380V AC-51 (kW)	3-ph Motor capacity 220-240/380-440V AC-53a (kW(A))	Rated operating voltage	Type ** application range (combination possible)	Certificate No.
US-N5SS**	5	1.9/-	0.4 (3.2) /-	DC12~24V	-	20060103 04174448
US-N8SS**	8	3.0/-	0.4 (3.2) /-		-	
US-N20**	20	7.6/13.1	2.2 (11.1) /3.7 (8.7)		CX, RM	20050103 04162980
US-N30**	30	11.4/19.7	3.7 (17.4) /7.5 (17.4)		CX	
US-N40**	40	15.2/26.3	5.5 (26) /11 (26)			
US-N50**	50	19.0/32.9	5.5 (26) /11 (26)			
US-N70NS**	70	26.6/-	11 (48) /-		-	20060103 04174451
US-N80NS**	80	30.4/-	11 (48) /-			
US-NH70NS**	65	24.7/42.7	11 (48) /22 (48)			
US-NH80NS**	75	28.5/49.3	11 (48) /22 (48)			

• 3-elements type

Table 1.1.4 (8-2)

Model Name	Approval rating AC-51 class (A)	3-ph Heater capacity 220/380V AC-51 (kW)	3-ph Motor capacity 220-240/380-440V AC-53a (kW(A))	Rated operating voltage	Type ** application range (combination possible)	Certificate No.
US-N5SSTE	5	1.9/-	0.4 (3.2) /-	DC12~24V	-	20060103 04174448
US-N8SSTE	8	3.0/-	0.4 (3.2) /-		-	
US-N20TE**	20	7.6/13.1	2.2 (11.1) /3.7 (8.7)		CX, RM	20050103 04162980
US-N30TE**	30	11.4/19.7	3.7 (17.4) /7.5 (17.4)		CX	
US-N40TE**	40	15.2/26.3	5.5 (26) /11 (26)			
US-N50TE**	50	17.1/29.6	5.5 (26) /11 (26)			
US-N70NSTE	70	26.6/-	11 (48) /-		-	20060103 04174451
US-N80NSTE	80	30.4/-	11 (48) /-			
US-NH70NSTE	65	24.7/42.7	11 (48) /22 (48)			
US-NH80NSTE	75	28.5/49.3	11 (48) /22 (48)			

■ Medium Voltage Vacuum Contactors

Table 1.1.4 (9)

Model Name SH : AC operated SHD : DC operated SL : Mechanical Latched(AC operated) SLD : Mechanical Latched(DC operated)	Approval rating AC-3 Class (200~240V/380~440V/1000V)		Conventional free air thermal current Ith (A)	Coil designation	Number of aux. contacts Standard	Certificate No.
	Rated capacity (kW)	Rated operational current (A)				
SH(D)-V160CN	45/90/220	180/180/160	200	AC100V-AC500V DC100V, DC200V	2a2b	20060103 04201618
SH(D)-V320CN	75/150/400	320/320/320	350			
SH(D)-V400CN	95/200/500	400/400/400	450			
SHL(D)-V160CN	45/90/220	180/180/160	200	AC100V-AC500V DC100V, DC200V	SHL : 2a2b SHLD : 2a4b	20060103 04201618
SHL(D)-V320CN	75/150/400	320/320/320	350			
SHL(D)-V400CN	95/200/500	400/400/400	450			

■ Voltage Detection Relays

Table 1.1.4 (10)

Model Name	Detectable voltage range Min~Max	Output contact arrangement	Certificate No.
SRE-AACN	AC3V-AC250V	1c	20070103 03224330
SRE-AAUCN	DC0.1V-DC250V		
SRE-KCN	AC75V-AC250V, DC9V-DC105V		
SRE-KTCN	AC80V-AC260V, DC10V-DC115V		

■ Solid State Time Delay Relays

Table 1.1.4 (11)

Model Name	Control voltage designation	Output contact arrangement	Certificate No.
SRS-HNPSCN	AC100V, AC200V, AC400V	Instantaneous : 1c, Delayed : 1c	20070103 03224347

1.1.5 Approved Marine Standards

■ Lloyd's Register of Shipping (LR) 

■ Bureau Veritas (BV) 

Table 1.1.5 (1)

Type	Model Name	BV Certificate No.	LR Certificate No.	Note
Contactor	S-N10, N11, N12, N20, N21(CX)	06139	95/10008	AC-3 Maximum 550V Standard model can be applied.
	SD-N11, N12, N21(CX)(SA)	2634/6987	96/10035	
	S-N18, N25, N28, N35(CX)(SA)/SD-N35(CX)(SA)	2634/6988	96/10034	
	S/SD-N50, N65, N80, N95	2634/07905	98/10016	
	S/SD-N125, N150, N220, N300, N400, S-N180	2634/07905	98/10016	
	S/SD-N600, N800	2634/07905	98/10016	
Thermal Overload Relay	TH-N12 (CX)(KP), N20(CX)(KP)	06139	95/10009	Maximum 550V Standard model can be applied.
	TH-N18(CX)(KP), N20TA(CX)(KP)	2634/6988	96/10033	
	TH-N60(KP), N60TA(KP), N120(KP), N120TA(KP), N220(KP), N400(KP)	2634/07905	98/10017	
	TH-N600(KP)	2634/07905	98/10017	
Contactor Relay	SR-N4(CX)	06139	95/10010	AC-15 Maximum 550V Standard model can be applied.
	SRD-N4(CX)	2634/6987	96/10035	
Auxiliary Contact Block	UN-AX2, AX4, AX11(CX)	06139	95/10010	Standard model can be applied.
	UN-AX80, AX150, AX600	2634/07905	98/10016	

■ Korean Register of Shipping (KR) 

Table 1.1.5 (2)

Contactor Model Name	Certificate No.	Contactor Model Name	Certificate No.	Contactor Model Name	Certificate No.
S-N10(CX)	KOB02571-EL020	S-N21(CX)	KOB02571-EL020	S-N95	KOB02571-EL020
S-KR11	KOB02571-EL018	S-N25(CX)(SA)	KOB02571-EL020	S-N125	KOB02571-EL020
S-N11(CX)	KOB02571-EL020	S-N35(CX)(SA)	KOB02571-EL020	S-N150	KOB02571-EL020
S-N12(CX)	KOB02571-EL020	S-N50	KOB02571-EL020	S-N220	KOB02571-EL020
S-N18(CX)(SA)	KOB02571-EL020	S-N65	KOB02571-EL020	S-N300	KOB02571-EL020
S-N20(CX)	KOB02571-EL020	S-N80	KOB02571-EL020	S-N400	KOB02571-EL020

Note: 1. Standard models are applicable. (AC3 Max. 440V according to JEM standard.)

■ Nippon Kaiji Kyokai (NK) 

Table 1.1.5 (3)

Contactor Model Name	Certificate No.	Contactor Model Name	Certificate No.	Contactor Model Name	Certificate No.		
S-N10(CX)	—	94T415	S-N125	SD-N125	98T407	SL(D)-N21NK	95T401
S-KR11	—	85T405	S-N150	SD-N150	98T408	SL(D)-N35NK	96T401
S-N11(CX)	SD-N11(CX)	94T416	S-N180	—	98T409	SL(D)-N50NK	98T413
S-N12(CX)	SD-N12(CX)	94T417	S-N220	SD-N220	98T410	SL(D)-N65NK	98T414
S-N18(CX)(SA)	—	95T404	S-N300	SD-N300	98T411	SL(D)-N80NK	98T415
S-N20(CX)	—	94T418	S-N400	SD-N400	98T412	SL(D)-N95NK	98T416
S-N21(CX)	SD-N21(CX)	94T419	S-N600	SD-N600	85T406	SL(D)-N125NK	98T417
S-N25(CX)(SA)	—	95T402	S-N800	SD-N800	85T407	SL(D)-N150NK	98T418
S-N35(CX)(SA)	SD-N35(CX)(SA)	95T403 96T401	S-N38(CX)(SA)	—	96T402	SL(D)-N220NK	98T419
S-N50	SD-N50	98T403	S-N48(CX)(SA)	—	96T403	SL(D)-N300NK	98T420
S-N65	SD-N65	98T404	B-N20	BD-N20	96T404	SL(D)-N400NK	98T421
S-N80	SD-N80	98T405	B-N65	BD-N65	01T401	SL(D)-N600NK	85T408
S-N95	SD-N95	98T406	B-N100	BD-N100	01T402	SL(D)-N800NK	85T409

Note: 1. Standard models are applicable. (AC3 Max. 440V according to JEM standard.)

1.2 Selection Guide



S-N11CX



S-2xN11



MSO-N12



S-N21CX



MSO-N35

Three-phase motor ratings IEC category AC-3 kW(hp)	220-240V	2.5(3-1/4)	3.5(4-1/2)	3.5(4-1/2)	4.5(6)	5.5(7-1/2)	5.5(7-1/2)	7.5(10)	11(15)
	380-440V	4(5-1/2)	5.5(7-1/2)	5.5(7-1/2)	7.5(10)	11(15)	11(15)	15(20)	18.5(25)
	500V	4(5-1/2)	5.5(7-1/2)	5.5(7-1/2)	7.5(10)	11(15)	11(15)	15(20)	18.5(25)
	690V	4(5-1/2)	5.5(7-1/2)	5.5(7-1/2)	7.5(10)	7.5(10)	7.5(10)	11(15)	15(20)
Conventional free air thermal current Ith A		20	20	20	25	32	32	50	60
Auxiliary contacts ¹	(standard)	1NO	1NO	1NO+1NC	— ²	1NO+1NC	2NO+2NC	2NO+2NC	2NO+2NC
	(special)	1NC	1NC	2NO	—	2NO	—	—	—
Number of additional auxiliary contact block for ³	1NO + 1NC (front)	1	1	1	1	1	1	1	1
	1NO + 1NC (side)	2	2	—	—	2	2	2	2
	2NO + 2NC (front)	1	1	1	1	1	1	1	1
	Low level signal (front) [1NO+1NC (+Standard 1NO + 1NC)]	1	1	1	1	1	1	1	1

Notes: 1. Number of auxiliary contact shows that for non-reversing type. Twice of the auxiliary contacts are provided on reversing type.
 2. (2NO + 2NC) × 2 auxiliary contacts are provided on reversing type and no additional contact can be mounted.
 3. Front clip-on and side clip-on block should not be mounted both.

Contactors

AC operated models	Non-reversing	S-N10(CX)	S-N11(CX)	S-N12(CX)	S-N18(CX)	S-N20(CX)	S-N21(CX)	S-N25(CX)	S-N35(CX)
	Reversing	S-2xN10(CX)	S-2xN11(CX)	—	S-2xN18(CX)	S-2xN20(CX)	S-2xN21(CX)	S-2xN25(CX)	S-2xN35(CX)
DC operated models		—	SD-N11(CX)	SD-N12(CX)	—	—	SD-N21(CX)	—	SD-N35(CX)

Note: 1. Products which model names are provided with suffix “CX” are provided with finger protection. (N10~N65)
 Especially N10~N35 with suffix “CX” are provided with CAN terminals.

Stators (AC operated)

Enclosed type (IP20)	MS-N10 (KP)	MS-N11 (KP)	MS-N12 (KP)	—	MS-N20 (KP)	MS-N21 (KP)	MS-N25 (KP)	MS-N35 (KP)
Open type (IP00)	MSO-N10 (KP)(CX)	MSO-N11 (KP)(CX)	MSO-N12 (KP)(CX)	MSO-N18 (KP)(CX)	MSO-N20 (KP)(CX)	MSO-N21 (KP)(CX)	MSO-N25 (KP)(CX)	MSO-N35 (KP)(CX)



Thermal Overload Relays¹

Three heater type with phase failure protection	TH-N12KP(CX)	TH-N18KP(CX)	TH-N20KP(CX)	TH-N20TAKP(CX)
Two heater type	TH-N12(CX)	TH-N18(CX)	TH-N20(CX)	TH-N20TA(CX)
Heater setting range A (Ordering designation)	0.1~0.16(0.12A) 0.14~0.22(0.17A) 0.2~0.32(0.24A) 0.28~0.42(0.35A) 0.4~0.6(0.5A) 0.55~0.85(0.7A) 0.7~1.1(0.9A) 1~1.6(1.3A) 1.4~2(1.7A)	1.7~2.5(2.1A) 2~3(2.5A) 2.8~4.4(3.6A) 4~6(5A) 5.2~8(6.6A) 7~11(9A) 9~13(11A) ²	1~1.6(1.3A) 1.4~2(1.7A) 1.7~2.5(2.1A) 2~3(2.5A) 2.8~4.4(3.6A) 4~6(5A) 5.2~8(6.6A) 7~11(9A) 9~13(11A) 12~18(15A)	0.2~0.32(0.24A) 0.28~0.42(0.35A) 0.4~0.6(0.5A) 0.55~0.85(0.7A) 0.7~1.1(0.9A) 1~1.6(1.3A) 1.4~2(1.7A) 1.7~2.5(2.1A) 2~3(2.5A) 2.8~4.4(3.6A) 4~6(5A) 5.2~8(6.6A) 7~11(9A) 9~13(11A) 12~18(15A) 16~22(19A) ³

Notes: 1. Saturable reactors for thermal overload relays are available as a kit or equipped with the relay. The suffix “SR” following the model name of the relay indicates “with saturable reactor”. (ex. TH-N20KPSR*5A) (Except for type TH-N12KP, TH-N18 and TH-N18KP)
 2. Except for size N10. 3. For size N20 & N21 only. 4. For size N35 only.

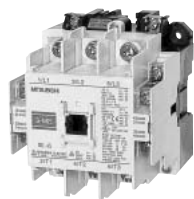

S-N65



S-N125



S-N400



S-N800

Table 1.2.1

15(20)	18.5(25)	22(30)	30(40)	37(50)	45(60)	55(75)	75(100)	90(125)	125(170)	190(250)	220(300)
22(30)	30(40)	45(60)	55(75)	60(80)	75(100)	90(125)	132(180)	160(210)	220(300)	330(450)	440(600)
25(34)	37(50)	45(60)	55(75)	60(80)	90(125)	110(150)	132(180)	160(210)	225(330)	330(450)	500(670)
22(30)	30(40)	45(60)	55(75)	60(80)	90(125)	110(150)	132(180)	200(270)	250(330)	330(450)	500(670)
80	100	135	150	150	200	260	260	350	450	800	1000
2NO+2NC	2NO+2NC	2NO+2NC	2NO+2NC	2NO+2NC	2NO+2NC	2NO+2NC	2NO+2NC	2NO+2NC	2NO+2NC	2NO+2NC	2NO+2NC
—	—	—	—	—	—	—	—	—	—	—	—
—	—	—	—	—	—	—	—	—	—	—	—
—	—	2	2	2	2	2	2	2	2	—	—
1	1	—	—	—	—	—	—	—	—	1	1
—	—	—	—	—	—	—	—	—	—	—	—

S-N50(CX)	S-N65(CX)	S-N80	S-N95	S-N125	S-N150	S-N180	S-N220	S-N300	S-N400	S-N600	S-N800
S-2×N50(CX)	S-2×N65(CX)	S-2×N80	S-2×N95	S-2×N125	S-2×N150	S-2×N180	S-2×N220	S-2×N300	S-2×N400	S-2×N600	S-2×N800
SD-N50	SD-N65	SD-N80	SD-N95	SD-N125	SD-N150	—	SD-N220	SD-N300	SD-N400	SD-N600	SD-N800

MS-N50 (KP)	MS-N65 (KP)	MS-N80 (KP)	MS-N95 (KP)	MS-N125 (KP)	MS-N150 (KP)	MS-N180 (KP)	MS-N220 (KP)	MS-N300 (KP)	MS-N400 (KP)	—	—
MSO-N50 (KP)(CX)	MSO-N65 (KP)(CX)	MSO-N80 (KP)	MSO-N95 (KP)	MSO-N125 (KP)	MSO-N150 (KP)	MSO-N180 (KP)	MSO-N220 (KP)	MSO-N300 (KP)	MSO-N400 (KP)	—	—



TH-N60KP(CX)	TH-N60TAKP	TH-N120KP	TH-N120TAKP	TH-N220RHKP	TH-N400RHKP	TH-N600KP ⁹
TH-N60(CX)	TH-N60TA	TH-N120	TH-N120TA	TH-N220RH	TH-N400RH	TH-N600 ⁹
12~18(15A) 18~26(22A) 24~34(29A) 30~40(35A) 34~50(42A) 43~65(54A)	54~80 (67A) 65~100(82A) 85~105(95A) ⁵	34~50 (42A) 43~65 (54A) 54~80 (67A) 65~100(82A)	85~125 (105A) 100~150(125A) ⁶	65~100 (82A) 85~125 (105A) 100~150(125A) 120~180(150A) 140~220(180A) ⁷ 170~250(210A) ⁷	85~125 (105A) 100~150(125A) 120~180(150A) 140~220(180A) 200~300(250A) 260~400(330A) ⁸	200~300(250A) 260~400(330A) 400~600(500A) 520~800(660A) ¹⁰

5. For size N95 only.

6. For size N150 only.

7. For size N220 only.

8. For size N400 only.

9. TH-N600(KP) must be used with the current transformers (to be supplied by the customer.) See Table 2.1.2.

10. For size N800 only.

1.3 The Overview (Type designation breakdown)

1.3.1 Non-Reversing Types

Table 1.3.1

Frame Size		N10	N11	N12	N18	N20	N21	N25	N35	N50	N65	N80	N95	N125	N150	N180	N220	N300	N400	N600	N800			
Spec	Rated capacity	220-240V	2.5	3.5	3.5	4.5	5.5	5.5	7.5	11	15	18.5	22	30	37	45	55	75	90	125	190	220		
	Category AC-3(kW)	380-440V	4	5.5	5.5	7.5	11	11	15	18.5	22	30	45	55	60	75	90	132	160	220	330	440		
Spec	Number of aux. contacts	Standard	1NO	1NO	1NO1NC	—	1NO1NC	← 2NO2NC →																
		Special	1NC	1NC	2NO	—	2NO	—	—	—	—	—	—	—	—	—	—	—	—	—	—	—	—	
ACCESSORIES	Additional aux. contact blocks	Front-on ¹	← 2P or 4P →										—	—	—	—	—	—	—	—	—	—		
		Side-on	← 1NO1NC×2(max.) →		—	← 1NO1NC×2(max.) →															2NO2NC×1(max.)			
	Surge absorber ³	← Attachable →										← Provided as a standard →												
	Mechanical interlock unit	← Attachable →		—	← Attachable →																			
CONTACTORS	Open	AC operated	S-□	○	○	○	○	○	○	○	○	○	○	○	○	○	○	○	○	○	○	○	○	
		DC operated	SD-□	—	○	○	—	○	—	○	○	○	○	○	○	○	○	○	○	○	○	○	○	○
		Finger protected	S-□CX	○	○	○	○	○	○	○	○	○	○	—	—	—	—	—	—	—	—	—	—	—
			SD-□CX	—	○	○	—	○	—	○	—	○	—	—	—	—	—	—	—	—	—	—	—	—
	Mechanically latched	SL(D)-□	—	—	—	—	○	—	○	○	○	○	○	○	○	○	○	○	○	○	○	○	○	
STARTERS	Open	AC operated	MSO-□	○	○	○	○	○	○	○	○	○	○	○	○	○	○	○	○	○	○	○	○	
		DC operated	MSOD-□	—	○	○	—	○	—	○	○	○	○	○	○	○	○	○	○	○	○	○	○	○
		With phase failure protection	MSO-□KP	○	○	○	○	○	○	○	○	○	○	○	○	○	○	○	○	○	○	○	○	○
	Enclosed Class IP20	Slow trip type with saturable reactor	MSO-□SR	○	○	○	—	○	○	○	○	○	○	○	○	○	○	○	○	○	○	○	○	○
		Quick-trip type with 2 heater elements	MSO-□FS	—	—	—	—	○	○	○	○	○	○	○	○	—	—	—	—	—	—	—	—	—
		Quick-trip type with phase failure protection	MSO-□KF	○	○	○	—	○	○	○	○	○	○	○	○	—	—	—	—	—	—	—	—	—
Enclosed Class IP20	Standard type	MS-□	○	○	○	—	○	○	○	○	○	○	○	○	○	○	○	○	○	○	○	○	○	
	With push button	MS-□PM	○	○	—	—	○	○	○	○	○	○	○	○	—	—	—	—	—	—	—	—	—	
	With phase failure protection	MS-□KP	○	○	○	—	○	○	○	○	○	○	○	○	○	○	○	○	○	○	○	○	○	
	Mounting on 35mm rail	← Available →										—	—	—	—	—	—	—	—	—	—	—		

Notes: 1. Additional head-on type aux. contact blocks cannot be attached to the enclosed type, mechanically latched type of size N50 & N65.
 2. Surge absorber is provided as a standard on ac operated contactors and starters of sizes N50 to N800.

1.3.2 Reversing Type

Table 1.3.2

Frame Size		2x N10	2x N11	2x N18	2x N20	2x N21	2x N25	2x N35	2x N50	2x N65	2x N80	2x N95	2x N125	2x N150	2x N180	2x N220	2x N300	2x N400	2x N600	2x N800		
Spec	Rated capacity	220-240V	2.5	3.5	4.5	5.5	5.5	7.5	11	15	18.5	22	30	37	45	55	75	90	125	190	220	
	Category AC-3(kW)	380-440V	4	5.5	7.5	11	11	15	18.5	22	30	45	55	60	75	90	132	160	220	330	440	
Spec	Number of aux. contacts	Standard	← 1NO1NC×2 →		2NO2NC ×2	1NO1NC ×2	← 2NO2NC×2 →										← 3NO3NC×2 →			← 4NO4NC ×2 →		
		Special	—	—	—	—	—	—	—	—	—	—	—	—	—	—	—	—	—	—	—	—
ACCESSORIES	Additional aux. contact blocks	Front-on ¹	← 4P×2 / 2P×2 →		—	← 4P×2 / 2P×2 →						—	—	—	—	—	—	—	—	—	—	—
		Side-on	← 1NO1NC×2 →		—	← 1NO1NC×2 →										—	—	—	—	—	—	
	Surge absorber ²	← Attachable →										← Provided as a standard →										
CONTACTORS	Open	AC operated	S-□	○	○	○	○	○	○	○	○	○	○	○	○	○	○	○	○	○	○	
		DC operated	SD-□	—	○	—	—	○	—	○	○	○	○	○	○	○	—	○	○	○	○	○
		Finger protected	S-□CX	○	○	○	○	○	○	○	○	○	—	—	—	—	—	—	—	—	—	—
		Mechanically latched	SL(D)-□	—	—	—	—	○	—	○	○	○	○	○	○	○	—	○	○	○	○	○
		AC operated	MSO-□	○	○	○	○	○	○	○	○	○	○	○	○	○	○	○	○	○	○	○
STARTERS	Open	DC operated	MSOD-□	—	○	—	—	○	—	○	○	○	○	○	○	—	○	○	○	○	—	
		With phase failure protection	MSO-□KP	○	○	○	○	○	○	○	○	○	○	○	○	○	○	○	○	○	○	—
		Slow trip type	MSO-□SR	○	○	—	○	○	○	○	○	○	○	○	○	○	○	○	○	○	○	—
		with saturable reactor	MSO-□SR	○	○	—	○	○	○	○	○	○	○	○	○	○	○	○	○	○	○	—
		Quick-trip type	MSO-□FS	—	—	—	○	○	○	○	○	○	○	—	—	—	—	—	—	—	—	—
STARTERS	Enclosed(IP20)	with 2 heater elements	MSO-□KF	○	○	—	○	○	○	○	○	○	—	—	—	—	—	—	—	—	—	
		with phase failure protection	MSO-□KF	○	○	—	○	○	○	○	○	○	—	—	—	—	—	—	—	—	—	—
		Standard type	MS-□	—	—	○	○	○	○	○	○	○	○	○	○	○	○	○	○	○	—	—
	With phase failure protection	MS-□KP	○	○	—	○	○	○	○	○	○	○	○	○	○	○	○	○	○	—	—	
Mounting on 35mm rail		← Available ³ →										—	—	—	—	—	—	—	—	—		

Notes: 1. Additional head-on type aux. contact blocks cannot be attached to the enclosed type, mechanically latched type of size N50 & N65.
 2. Surge absorber is provided as a standard on ac operated contactors and starters of sizes 2xN50 to 2xN800.
 3. Remove a mounting plate for mounting on 35mm rail of sizes 2xN25 to 2xN65.

1.4 Technical Data of Series S-N Contactors

1.4.1 Ratings and Characteristics

Contactor		Type	S/SD-				S/SD-		S/SD-		S/SD-	
			S-N10	N11, N12	S-N18	S-N20	N21	S-N25	N35	N50	N65	
Rated insulation voltage		V	690	690	690	690	690	690	690	690	690	
Conventional free air thermal current		lth	A	20	20	25	32	32	50	60	80	100
Rated capacity for resistive loads												
3-ph, Category AC-1	220-240V	kW(A)	7.5(20)	7.5(20)	9.5(25)	12(32)	12(32)	18(50)	20(60)	30(80)	35(100)	
	380-440V	kW(A)	7(11)	8.5(13)	13(20)	20(32)	20(32)	30(50)	35(60)	50(80)	65(100)	
	500V	kW(A)	7(8)	9.5(11)	13(16)	25(32)	25(32)	40(50)	50(60)	65(80)	85(100)	
	690V	kW(A)	7(6)	8(8)	11(10)	30(32)	30(32)	50(50)	60(60)	80(80)	100(100)	
Rated operational current												
3-ph, Category AC-3	220-240V	A	11	13	18	22	22	30	40	55	65	
	380-440V	A	9	12	16	22	22	30	40	50	65	
	500V	A	7	9	13	17	17	24	32	38	60	
	690V	A	5	7	9	9	9	12	17	26	38	
Rated capacity for jogging of AC motors												
3-ph, category AC-4 Electrical life is ca. 200,000 operations	220-240V	kW	0.75	1.1	1.5	2.2	2.2	3	3.7	5.5	7.5	
	380-440V	kW	1.1	1.5	2.2	3.7	3.7	5.5	5.5	7.5	11	
	500V	kW	1.1	1.5	2.2	3.7	3.7	5.5	5.5	7.5	11	
	690V	kW	1.1	1.5	2.2	3.7	3.7	5.5	5.5	7.5	11	
Max. current for AC-4 duty at 440V		A	6	9	9	13	13	17	24	32	47	
Rated current for DC non-inductive loads												
Category DC-1 100 operations/hour max. 500,000 operations	48V	A	10	12	12	20	20	25	35	50	65	
	110V	A	8	12	12	20	20	25	35	50	65	
	220V	A	8	12	12	20	20	22	30	40	50	
Rated Current for DC motors												
Category DC-2 & DC-4 100 operations/hour max. 500,000operations	48V	A	6	10	10	20	20	25	30	35	40	
	110V	A	4	8	8	15	15	20	20	30	35	
	220V	A	2	4	4	8	8	10	10	12	15	
Applicable standard: JEM-1038 (JAPAN)												
Rated capacity for 3-ph, capacitors ⁴												
120 operations/hour max. Electrical durability at maximum load: 100,000 operations (ambient temperature 40°C)	220-240V	kvar	2.2	3	4	5.5	5.5	8.5	12	20	20	
	380-440V	kvar	3.3	4	6	10	10	14	20	40	40	
	550V	kvar	4	5	6	10	10	14	20	30	35	
	690V	kvar	3.3	4.5	5.5	10	10	14	20	30	40	
Making & breaking												
3-ph, cosθ=0.35 240V/440V	Making current	A	110/110	130/120	180/180	220/220	220/220	300/300	400/400	550/460	650/620	
	Breaking current	A	100/72	120/100	180/130	220/220	220/220	300/240	400/320	550/460	650/620	
Switching frequency												
	Category AC-1	operations/hour	1,800	1,800	1,800	1,800	1,800	1,800	1,800	1,200	1,200	
	Category AC-3	operations/hour	1,800	1,800	1,800	1,800	1,800	1,800	1,800	1,200	1,200	
	Category AC-4	operations/hour	600	600	600	600	600	600	600	600	600	
Operating time (at rated coil voltage)												
AC operated	Closing	ms	15	15	15	15	15	15	15	25	25	
	Opening	ms	10	10	10	10	10	10	10	53	53	
DC operated	Closing	ms	—	45	—	—	33	—	50	57	57	
	Opening	ms	—	10	—	—	12	—	13	15	15	
Coil consumption (at rated coil voltage)												
AC operated	Inrush	VA	45	45	60	90	90	110	110	115	115	
	Sealed	VA	7	7	10	15	15	13	13	20	20	
	Watts	W	2.4	2.4	3	4	4	4.3	4.3	2.2	2.2	
DC operated	Inrush	VA	—	7	—	—	9	—	9	18	18	
	Sealed	VA	—	7	—	—	9	—	9	18	18	
Coil voltage tolerance		0.85 to 1.1 times rated coil voltage										
Mechanical endurance (make/break operations)		million	10	10	10	10	10	10	10	5	5	
Permissible ambient temperature		°C	-25 to +55									
Vibration (10-55 Hertz)		m/s ²	19.6									
Shock (10 ms half sine wave)		m/s ²	49									
Conductor size	Main terminal (contactor)	mm ²	1-2.5	1-2.5	1-6	1-6	1-6	2-16	2-16	2-25	2-25	
	Main terminal (overload relay)	mm ²	1-2.5	1-2.5	1-6	1-6	1-6	2-16	2-16	2-25	2-25	
Control terminal		mm ²	1-2.5	1-2.5	1-2.5	1-2.5	1-2.5	1-2.5	1-2.5	1-2.5	1-2.5	
Busbar width		mm	—	—	—	—	—	—	—	—	—	

Notes: 1. 660A at ambient temperature 40-55°C. 2. 800A at ambient temperature 40-55°C.

3. Conductor size in parentheses indicate compression terminal style not for bare clamping.

4. The peak value of inrush current should be less than 2000% of the effective value for rated current of capacitors.

The selection is invalid for the circuit of parallel capacitors which are controlled individually.

Table 1.4.1 (1)

S/SD-N80	S/SD-N95	S/SD-N125	S/SD-N150	S-N180	S/SD-N220	S/SD-N300	S/SD-N400	S/SD-N600	S/SD-N800
690	690	690	690	690	690	690	690	690	690
135	150	150	200	260	260	350	450	800 ¹	1000 ²
50(135)	55(150)	55(150)	75(200)	95(260)	95(260)	130(350)	170(450)	250(660)	300(800)
85(135)	90(150)	90(150)	130(200)	170(260)	170(260)	230(350)	290(450)	430(660)	530(800)
110(135)	120(150)	120(150)	170(200)	220(260)	220(260)	300(350)	380(450)	570(660)	700(800)
135(135)	150(150)	150(150)	200(200)	260(260)	260(260)	350(350)	450(450)	660(660)	900(800)
85	105	125	150	180	250	300	400	630	800
85	105	120	150	180	250	300	400	630	800
75	85	90	140	180	200	250	350	500	720
52	65	70	100	120	150	220	300	420	630
7.5	11	15	18.5	22	22	37	45	65	75
15	18.5	22	30	37	45	60	75	110	130
15	18.5	22	37	45	55	60	90	130	150
15	18.5	22	30	50	55	75	90	130	150
62	75	90	110	150	180	220	300	400	630
80	93	120	150	180	220	300	400	630	800
80	93	100	150	180	220	300	400	630	800
60	70	80	150	180	220	300	300	630	800
60	90	90	130	180	220	280	280	630	630
50	80	80	120	150	150	200	200	630	630
20	50	50	80	100	100	150	150	630	630
35	35	38	50	60	60	95	115	190	190
60	60	65	80	120	120	150	200	350	350
48	60	65	80	150	150	200	250	350	350
50	60	65	80	150	150	200	200	400	400
850/850	1050/1050	1250/1250	1500/1500	1800/1800	2500/2500	3000/3000	4000/4000	6500/6500	8000/8000
800/750	930/930	1000/1000	1200/1200	1450/1450	2000/2000	2400/2400	3200/3200	5040/5040	6400/6400
1,200	1,200	1,200	1,200	1,200	1,200	1,200	1,200	1,200	1,200
1,200	1,200	1,200	1,200	1,200	1,200	1,200	1,200	1,200	1,200
600	300	300	300	300	300	300	300	300	300
27	27	25	27	30	30	35	35	65	65
75	75	85	85	100	100	120	120	75	75
75	75	125	135	—	145	175	175	105	105
18	18	22	37	—	40	55	55	80	80
210	210	270	270	440	440	440	440	790	790
23	23	24	24	40	40	50	50	90	90
2.8	2.8	2.9	2.9	4.2	4.2	6.1	6.1	17	17
24	24	31	31	—	41	55	55	600	600
24	24	31	31	—	41	55	55	72	72
0.85 to 1.1 times rated coil voltage									
5	5	5	5	5	5	5	5	5	5
-25 to +55									
19.6									
49									
2-60	(2-60) ³	(6-70) ³	(6-95) ³	(10-120) ³	(10-150) ³	(25-240) ³	(25-240) ³	(70-325) ³	(70-325) ³
2-50	2-50	(6-70) ³	(6-95) ³	(10-120) ³	(10-150) ³	(25-240) ³	(25-240) ³	—	—
1-2.5	1-2.5	1-2.5	1-2.5	1-2.5	1-2.5	1-2.5	1-2.5	1-4	1-4
15	15	15	20	25	25	30	30	35	35

Rated operating current of auxiliary contacts

Table 1.4.1 (2)

Conventional free air thermal current	A	16
Rated operating current		
Category 120VAC	A	6
AC-15 240VAC	A	5
500VAC	A	3
660VAC	A	1.5
Category 24VDC	A	5
48VDC	A	3
DC-13 110VDC	A	0.6
	A	0.8 ¹
220VDC	A	0.2

Note: 1 UN-AX2(CX), UN-AX4(CX), UN-AX11(CX).

1.4.2 Performance of Series S-N Contactors

Electrical Life

The electrical life of the main contacts of a contactor is determined mainly by the circuit-opening duty it will perform. The relationship between electrical life and rated current of Mitsubishi contactors under normal and jogging duties of squirrel-cage motors is shown in Fig. 1.4.2(1) and 1.4.2(2). In the case of a mixture of normal and jogging duties, the expected contactor life can be determined as follows:

$$N = Nr/1 + \frac{\alpha}{100} (Nr/Ni - 1) \dots\dots\dots \text{Eq.1.1}$$

where N : Life in the case of α% jogging duty
 Nr : Life in the case of normal duty
 Ni : Life in the case of 100% jogging duty
 α : Percentage of jogging duty

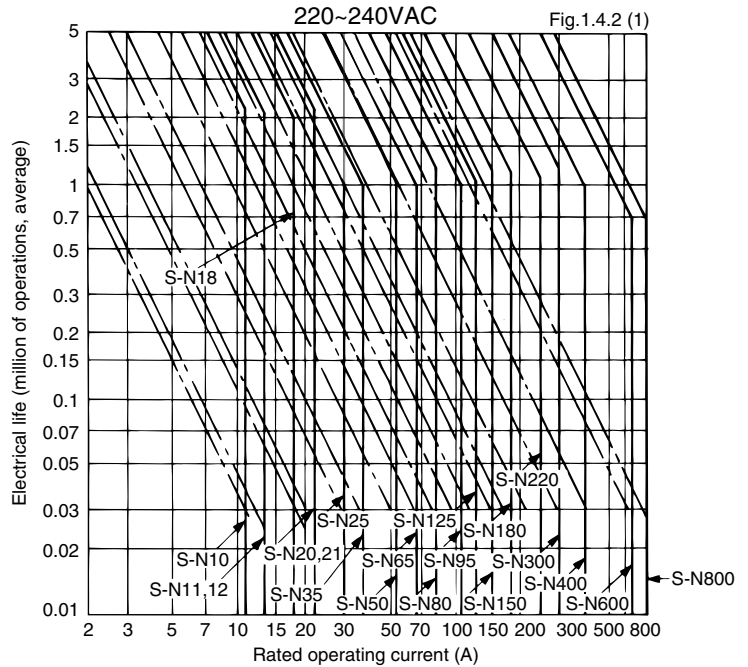

Electrical life versus rated operating current

— Normal duty, 6le on, 6le off, on-load factor 40%,
 1200 operations/hour (AC3)
 - - - Jogging duty, 6le on, 6le off, on-load factor 7%,
 600 operations/hour (AC4)-S-N10~S-N300
 300 operations/hour (AC4)-S-N400~S-N600
 150 operations/hour (AC4)-S-N800

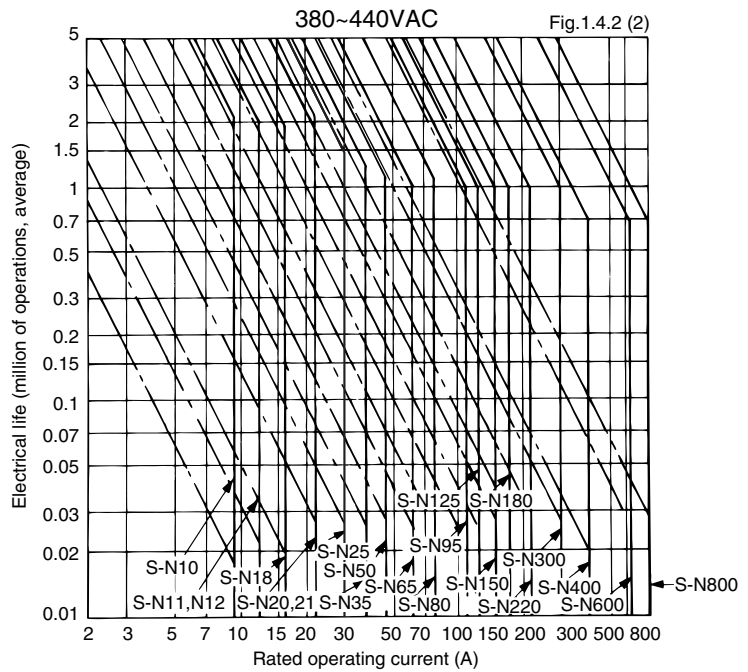

1.4.3 Mounting Attitude of Starters and Contactors

To assure proper performance, Mitsubishi magnetic motor starters and contactors should be mounted on a vertical supporting surface with the line terminals upwards and the load terminals downwards. The supporting surface may have a maximum inclination of 30° from the vertical in any direction.

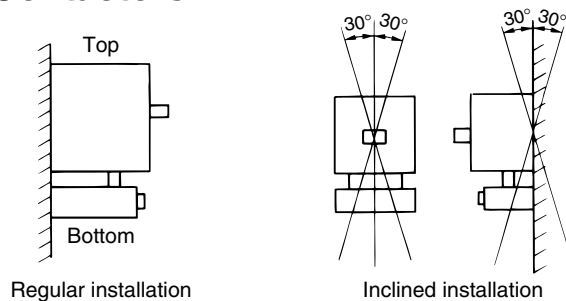

1.5 When Ordering

Contactors, indicate the model name and the ordering designation of the coil.

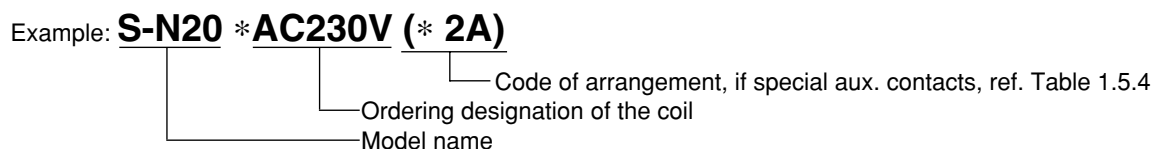

Overload relays, indicate the model name and the ordering designation of the heater setting range.

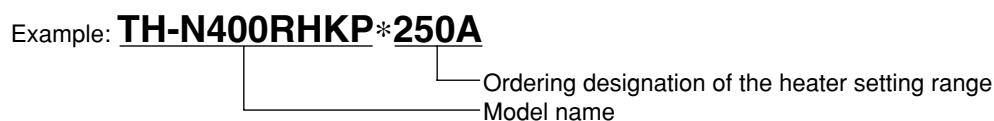

Motor starters, indicate the model name, heater setting range, main circuit voltage, coil designation.

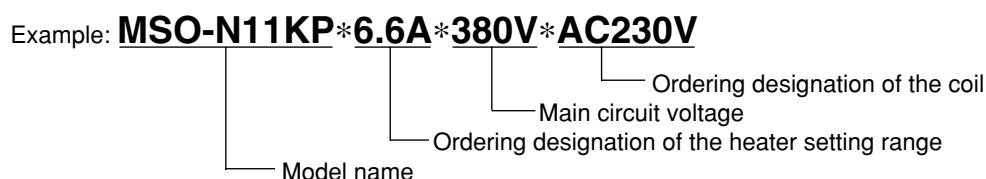

Note: Mark * indicates a blank space.

Coil Ratings and Ordering Designations

for **S-N10(CX), -N11(CX), -N12(CX), -N18(CX), -N20(CX), -N21(CX), -N25(CX), -N35(CX)** and **SR-N(CX)**

Table 1.5.1

Rated voltage (VAC)		Ordering designation
50Hz	60Hz	
24	24	AC24V
48~50	48~50	AC48V
100	100~110	AC100V
110~120	115~120	AC120V
125~127	127	AC127V
200	200~220	AC200V
208~220	220	AC220V
220~240	230~240	AC230V
240~260	260~280	AC260V
346~380	380	AC380V
380~415	400~440	AC400V
415~440	460~480	AC440V
500	500~550	AC500V

for **S-N50(CX)~N800**

Table 1.5.2

Rated voltage (50/60Hz)	Ordering designation
100~127V	AC100V
200~240V	AC200V
260~350V	AC300V
380~440V	AC400V
460~550V	AC500V

AC24V, AC48V are available for S-N50(CX)~N150

for **SD-N, SRD-N**

Table 1.5.3

Rated voltage (VDC)	Ordering designation
24	DC24V
48	DC48V
100	DC100V
110	DC110V
120~125	DC125V
200	DC200V
220	DC220V

Code of arrangement for special aux. Contacts

Table 1.5.4

Arrangement	Code
1NC	1B
2NO	2A

A : Normally Open

B : Normally Closed

1.6 Selection Table of Contactors

1.6.1 Non-Reversing Contactors

Type S-N□, SD-N□

Ordering Designation

Model name S-N10
 Coil designation (See page 13) AC400V
 If required special aux. contact (never specify for standard) 1B
 Complete type designation S-N10*AC400V*1B

Note: Mark*indicates a blank space.

Table 1.6.1

Rated operational current AC-3		Rated motor capacity 3-phase AC-2 & AC-3				Model name		Standard aux. contacts		Finger protection terminal cover	Additional auxiliary contact block											
220V	380V	220V	380V	500V	690V	AC operated	DC operated	NO	NC		UN-AX2(CX)	UN-AX4(CX)	UN-AX11(CX)	UN-AX80	UN-AX150	UN-AX600						
11	9	2.5	4	4	4	S-N10	—	1	—	Provided	1	—	—	—	—	—						
						S-N10CX ¹	—	—	—	—												
						S-N10(1B)	—	—	1	—												
						S-N10CX ¹ (1B)	—	—	—	—												
13	12	3.5	5.5	5.5	5.5	S-N11	SD-N11	1	—	—									2	—	—	—
						S-N11CX ¹	SD-N11CX ¹	—	—	—												
						S-N11(1B)	SD-N11(1B)	—	1	—												
						S-N11CX ¹ (1B)	SD-N11CX ¹ (1B)	—	—	—												
13	12	3.5	5.5	5.5	5.5	S-N12	SD-N12	1	1	—												
						S-N12CX ¹	SD-N12CX ¹	—	—	—												
						S-N12(2A)	SD-N12(2A)	2	—	—												
						S-N12CX ¹ (2A)	SD-N12CX ¹ (2A)	—	—	—												
18	16	4.5	7.5	7.5	7.5	S-N18	—	—	—	—												
						S-N18CX ¹	—	—	—	—												
22	22	5.5	11	11	7.5	S-N20	—	1	1	—												
						S-N20CX ¹	—	—	—	—												
						S-N20(2A)	—	2	—	—												
						S-N20CX ¹ (2A)	—	—	—	—												
22	22	5.5	11	11	7.5	S-N21	SD-N21	2	2	—												
						S-N21CX ¹	SD-N21CX ¹	—	—	—												
30	30	7.5	15	15	11	S-N25	—	2	2	—												
						S-N25CX ¹	—	—	—	—												
40	40	11	18.5	18.5	15	S-N35	SD-N35	2	2	—												
						S-N35CX ¹	SD-N35CX ¹	—	—	—												
55	50	15	22	25	22	S-N50	SD-N50	2	2	—												
						S-N50CX ¹	SD-N50CX ¹	—	—	—												
65	65	18.5	30	37	30	S-N65	SD-N65	2	2	—												
						S-N65CX ¹	SD-N65CX ¹	—	—	—												
85	85	22	45	45	45	S-N80	SD-N80	2	2	—												
105	105	30	55	55	55	S-N95	SD-N95	2	2	—				Max. 2	—	—						
125	120	37	60	60	60	S-N125	SD-N125	2	2	—												
150	150	45	75	90	90	S-N150	SD-N150	2	2	—												
180	180	55	90	110	110	S-N180	—	2	2	—												
250	250	75	132	132	132	S-N220	SD-N220	2	2	—					Max. 2	—						
300	300	90	160	160	200	S-N300	SD-N300	2	2	—												
400	400	125	220	225	250	S-N400	SD-N400	2	2	—												
630	630	190	330	330	330	S-N600	SD-N600	2	2	—												
800	800	220	440	500	500	S-N800	SD-N800	2	2	—						1						

Note: 1 "CX" denotes with finger protection terminal covers.

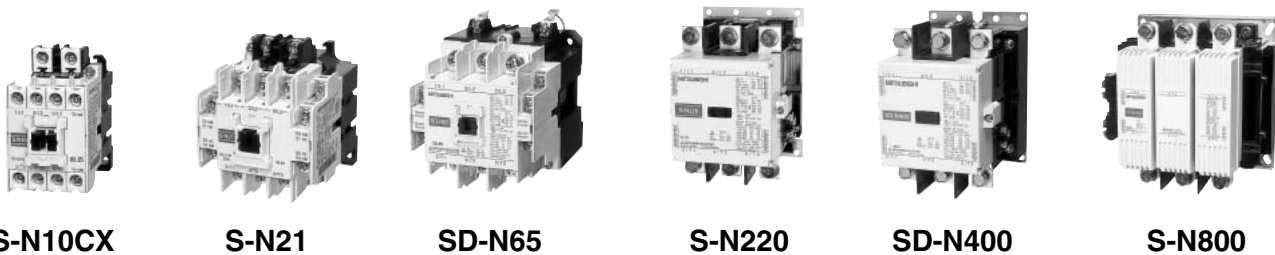

1.6.2 Reversing Contactors

Type S-2xN□,SD-2xN□

Ordering Designation

Model name..... S-2xN95
 Coil designation (See page 13) AC400V
 Complete type designation S-2xN95*AC400V

Note: Mark*indicates a blank space.

Table 1.6.2

Rated operational current AC-3		Rated motor capacity 3-phase AC-2 & AC-3				Model name		Standard aux. contacts		Additional auxiliary contact block(max).				
220 -240V (A)	380 -440V (A)	220 -240V (kW)	380 -440V (kW)	500V (kW)	690V (kW)	AC operated	DC operated	NO	NC	UN- AX2(CX)	UN- AX4(CX)	UN- AX11(CX)	UN- AX80	UN- AX150
11	9	2.5	4	4	4	S-2xN10 S-2xN10CX ¹	—	2	2	2	2	2	—	—
13	12	3.5	5.5	5.5	5.5	S-2xN11 S-2xN11CX ¹	SD-2xN11 SD-2xN11CX ¹	2	2	2	2	2	—	—
18	16	4.5	7.5	7.5	7.5	S-2xN18 S-2xN18CX ¹	—	4	4	—	—	—	—	—
22	22	5.5	11	11	7.5	S-2xN20 S-2xN20CX ¹	—	2	2	—	—	—	—	—
22	22	5.5	11	11	7.5	S-2xN21 S-2xN21CX ¹	SD-2xN21 SD-2xN21CX ¹	4	4	—	—	—	—	—
30	30	7.5	15	15	11	S-2xN25 S-2xN25CX ¹	—	4	4	2	2	2	—	—
40	40	11	18.5	18.5	15	S-2xN35 S-2xN35CX ¹	SD-2xN35 SD-2xN35CX ¹	4	4	—	—	—	—	—
55	50	15	22	25	22	S-2xN50 S-2xN50CX ¹	SD-2xN50	4	4	—	—	—	—	—
65	65	18.5	30	37	30	S-2xN65 S-2xN65CX ¹	SD-2xN65	4	4	—	—	—	—	—
85	85	22	45	45	45	S-2xN80	SD-2xN80	4	4	—	—	—	2	—
105	105	30	55	55	55	S-2xN95	SD-2xN95	4	4	—	—	—	—	—
125	120	37	60	60	60	S-2xN125	SD-2xN125	4	4	—	—	—	—	—
150	150	45	75	90	90	S-2xN150	SD-2xN150	6	6	—	—	—	—	—
180	180	55	90	110	110	S-2xN180	—	6	6	—	—	—	—	—
250	250	75	132	132	132	S-2xN220	SD-2xN220	6	6	—	—	—	—	2
300	300	90	160	160	200	S-2xN300	SD-2xN300	6	6	—	—	—	—	—
400	400	125	220	225	250	S-2xN400	SD-2xN400	6	6	—	—	—	—	—
630	630	190	330	330	330	S-2xN600	SD-2xN600	8	8	—	—	—	—	—
800	800	220	440	500	500	S-2xN800	SD-2xN800	8	8	—	—	—	—	—

Note:1 "CX" denotes with finger protection terminal covers.



S-2xN11

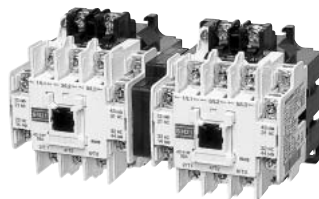

S-2xN21



S-2xN150

1.6.3 Non-Reversing Mechanically Latched Contactors

Type SL-N□, SLD-N□



Ordering Designation

Model name SL-N35
 Closing coil designation¹ AC200V
 Tripping coil designation¹ DC100V

Complete type designation SL-N35*MC-AC200V*MT-DC100V

Note: Mark*indicates a blank space.
 1. See Table 1.6.3 (2).

Table 1.6.3 (1)

Rated operational current AC-3		Rated motor capacity 3-phase AC-2 & AC-3				Model name		Standard free aux. contacts	Additional auxiliary contact block				
220 -240V (A)	380 -440V (A)	220 -240V (kW)	380 -440V (kW)	500V (kW)	690V (kW)	AC operated (closing coil)	DC operated (closing coil)			UN-AX11	UN-AX80	UN-AX150	UN-AX600
22	22	5.5	11	11	7.5	SL-N21	SLD-N21	2	2	Max.2	—	—	—
40	40	11	18.5	18.5	15	SL-N35	SLD-N35	2	2				
55	50	15	22	25	22	SL-N50	SLD-N50	2	2				
65	65	18.5	30	37	30	SL-N65	SLD-N65	2	2				
85	85	22	45	45	45	SL-N80	SLD-N80	1	2	—	Max.2	—	—
105	105	30	55	55	55	SL-N95	SLD-N95	1	2				
125	120	37	60	60	60	SL-N125	SLD-N125	1	2	—	—	Max.2	—
150	150	45	75	90	90	SL-N150	SLD-N150	1	2				
250	250	75	132	132	132	SL-N220	SLD-N220	1	2				
300	300	90	160	160	200	SL-N300	SLD-N300	1	2				
400	400	125	220	225	250	SL-N400	SLD-N400	1	2	—	—	—	1
630	630	190	330	330	330	SL-N600	SLD-N600	1	2				
800	800	220	440	500	500	SL-N800	SLD-N800	1	2				

• Coil Ratings (Closing & Tripping)

Table 1.6.3 (2)

Ordering designation	Applicable voltage
AC100V	100-127VAC 50/60Hz
AC200V	200-240VAC 50/60Hz
AC300V	260-350VAC 50/60Hz
AC400V	380-440VAC 50/60Hz
AC500V	460-550VAC 50/60Hz
DC24V	24VDC
DC48V	48VDC
DC100V	100-110VDC
DC125V	120-125VDC
DC200V	200-220VDC

• Precautions

- Minimum energising time, both for closing and tripping must be set longer than the followings.
 SL(D)-N21 to N220 : 0.3 sec.
 SL(D)-N300 to N800 : 0.5 sec.
- Make sure never to over lap the energising time for closing and tripping.

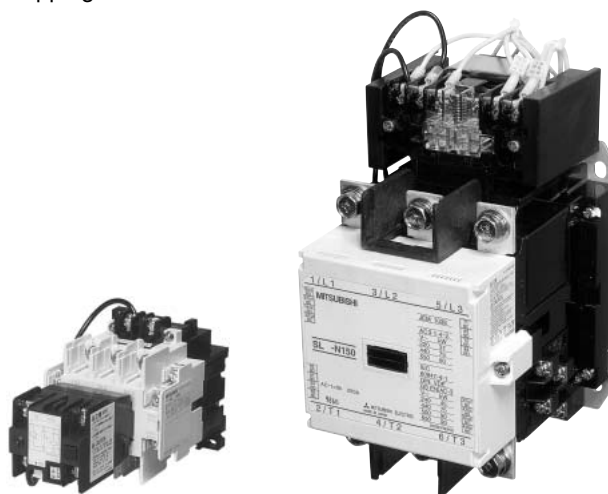

SL-N35

SL-N150

1.6.4 Reversing Mechanically Latched Contactors

(Components for Automatic Transfer Switches)

Type **SL-2xN□**, **SLD-2xN□**, **SLxS-N□**

Ordering Designation

• Mechanically latched & mechanically latched contactor	
Model name	SL-2xN35
Closing coil designation in normal left side ¹	AC200V
Tripping coil designation in normal left side ¹	DC100V
Closing coil designation in standby right side ¹	DC100V
Tripping coil designation in standby right side ¹	AC200V
Complete type designation	SL-2xN35*MC1-AC200V*MT1-DC100V*MC2-DC100V*MT2-AC200V
• Mechanically latched & normal contactor	
Model name	SLxS-N150
Closing coil designation in normal left side ¹	AC200V
Tripping coil designation in normal left side ¹	AC100V
Coil designation in standby right side ²	AC100V
Complete type designation	SLxS-N150*MC1-AC200V*MT1-AC100V*AC100V

Notes: Mark*indicates a blank space.

1. See Table 1.6.3(2) 2. See Table 1.5.2

Table 1.6.4

Rated operational current AC-3		Rated motor capacity 3-phase AC-2 & AC-3				Model name mechanically latched & mechanically latched			Mechanically latched & normal			Additional auxiliary contact block		
220	380	220	380			AC operated	DC operated	AC operated	UN-AX11	UA-AX80	UA-AX150			
-240V	-440V	-240V	-440V	500V	690V	(closing coil)	(closing coil)	(closing coil)						
(A)	(A)	(kW)	(kW)	(kW)	(kW)									
22	22	5.5	11	11	7.5	SL-2xN21	SLD-2xN21	—	Max.2	—	—			
40	40	11	18.5	18.5	15	SL-2xN35	SLD-2xN35	—						
55	50	15	22	25	22	SL-2xN50	SLD-2xN50	—						
65	65	18.5	30	37	30	SL-2xN65	SLD-2xN65	SLxS-N65						
85	85	22	45	45	45	SL-2xN80	SLD-2xN80	—	—	Max.2	—			
105	105	30	55	55	55	SL-2xN95	SLD-2xN95	—						
125	120	37	60	60	60	SL-2xN125	SLD-2xN125	SLxS-N125						
150	150	45	75	90	90	SL-2xN150	SLD-2xN150	SLxS-N150	—	—	Max.2			
250	250	75	132	132	132	SL-2xN220	SLD-2xN220	SLxS-N220						
300	300	90	160	160	200	SL-2xN300	SLD-2xN300	SLxS-N300						
400	400	125	220	225	250	SL-2xN400	SLD-2xN400	SLxS-N400						
630	630	190	330	330	330	SL-2xN600	SLD-2xN600	—	—	—	—			
800	800	220	440	500	500	SL-2xN800	SLD-2xN800	—						

• Precautions

- Minimum energising time both for closing and tripping must be set longer than the followings.

SL(D)-2xN21 to N220, SLxS-N65 to N220 : 0.3 sec.

SL(D)-2xN300 to N800, SLxS-N300 and N400 : 0.5 sec.

Make sure never to overlap the energising time for closing and tripping.



SL-2xN35

1.7 Selection Table of Direct-On-Line Motor Starters

1.7.1 Non-Reversing Motor Starters without Enclosure (IP 00)

Type MSO-N□

Ordering Designation

Model name MSO-N50KP
 Heater designation of overload relay 42A
 Main circuit voltage 440V
 Coil designation (See page 13) AC200V
 Complete type designation MSO-N50KP*42A*440V*AC200V

Note: Mark*indicates a blank space.

Table 1.7.1

Rated operational current AC-3		Rated motor capacity 3-phase AC-2 & AC-3				Model name		Aux. contacts	Heater designation of overload relay
220 -240V (A)	380 -440V (A)	220 -240V (kW)	380 -440V (kW)	500V (kW)	690V (kW)	Phase failure protection type	Two heater type	(ordering designation)	
11	9	2.5	4	4	4	MSO-N10KP MSO-N10CXKP ¹	MSO-N10	1 —	0.12A, 0.17A, 0.24A, 0.35A, 0.5A, 0.7A 0.9A, 1.3A, 1.7A, 2.1A, 2.5A, 3.6A, 5A 6.6A, 9A
13	12	3.5	5.5	5.5	5.5	MSO-N11KP MSO-N11CXKP ¹	MSO-N11	1 —	
13	12	3.5	5.5	5.5	5.5	MSO-N12KP MSO-N12CXKP ¹	MSO-N12	1 1	15A
18	16	4.5	7.5	7.5	7.5	MSO-N18KP MSO-N18CXKP ¹	MSO-N18	— —	19A
22	22	5.5	11	11	7.5	MSO-N20KP MSO-N20CXKP ¹	MSO-N20	1 1	0.24A, 0.35, 0.5A, 0.7A, 0.9A, 1.3A, 1.7A, 2.1A, 2.5A, 3.6A, 5A, 6.6A, 9A, 11A, 15A
22	22	5.5	11	11	7.5	MSO-N21KP MSO-N21CXKP ¹	MSO-N21	2 2	
30	30	7.5	15	15	11	MSO-N25KP MSO-N25CXKP ¹	MSO-N25	2 2	35A
40	40	11	18.5	18.5	15	MSO-N35KP MSO-N35CXKP ¹	MSO-N35	2 2	15A, 22A, 29A, 35A, 42A, 54A
55	50	15	22	25	22	MSO-N50KP MSO-N50CXKP ¹	MSO-N50	2 2	
65	65	18.5	30	37	30	MSO-N65KP MSO-N65CXKP ¹	MSO-N65	2 2	95A
85	85	22	45	45	45	MSO-N80KP	MSO-N80	2 2	42A, 54A, 67A, 82A, 105A
105	105	30	55	55	55	MSO-N95KP	MSO-N95	2 2	
125	120	37	60	60	60	MSO-N125KP	MSO-N125	2 2	82A, 105A, 125A, 150A
150	150	45	75	90	90	MSO-N150KP	MSO-N150	2 2	
180	180	55	90	110	110	MSO-N180KP	MSO-N180	2 2	105A, 125A, 150A, 180A, 250A
250	250	75	132	132	132	MSO-N220KP	MSO-N220	2 2	
300	300	90	160	160	200	MSO-N300KP	MSO-N300	2 2	
400	400	125	220	225	250	MSO-N400KP	MSO-N400	2 2	

Note: 1. "CX" denotes with finger protection terminal covers.



MSO-N11CXKP



MSO-N18KP



MSO-N50



MSO-N125KP



MSO-N220

1.7.2 Reversing Motor Starters without Enclosure (IP 00)

Type MSO-2xN□

Ordering Designation

Model name MSO-2xN35KP
 Heater designation of overload relay 29A
 Main circuit voltage 440V
 Coil designation (See page 13) AC200V

Complete type designation MSO-2xN35KP*29A*440V*AC200V

*Note: Mark*indicates a blank space.*

Table 1.7.2

Rated operational current AC-3		Rated motor capacity 3-phase AC-2 & AC-3				Model name		Free aux. contacts	Heater designation of overload relay
220 -240V (A)	380 -440V (A)	220 -240V (kW)	380 -440V (kW)	500V (kW)	690V (kW)	Phase failure protection type	Two heater type	(ordering designation)	
11	9	2.5	4	4	4	MSO-2xN10KP MSO-2xN10CXKP ¹	MSO-2xN10	2 —	0.12A, 0.17A, 0.24A, 0.35A, 0.5A, 0.7A
13	12	3.5	5.5	5.5	5.5	MSO-2xN11KP MSO-2xN11CXKP ¹	MSO-2xN11	2 —	0.9A, 1.3A, 1.7A, 2.1A, 2.5A, 3.6A, 5A
18	16	4.5	7.5	7.5	7.5	MSO-2xN18KP MSO-2xN18CXKP ¹	MSO-2xN18	4 2	6.6A, 9A, 11A
22	22	5.5	11	11	7.5	MSO-2xN20KP MSO-2xN20CXKP ¹	MSO-2xN20	2 —	15A
22	22	5.5	11	11	7.5	MSO-2xN21KP MSO-2xN21CXKP ¹	MSO-2xN21	4 2	0.24A, 0.35A, 0.5A, 0.7A, 0.9A, 1.3A, 1.7A, 2.1A, 2.5A, 3.6A, 5A, 6.6A, 9A, 11A, 15A
30	30	7.5	15	15	11	MSO-2xN25KP MSO-2xN25CXKP ¹	MSO-2xN25	4 2	19A
40	40	11	18.5	18.5	15	MSO-2xN35KP MSO-2xN35CXKP ¹	MSO-2xN35	4 2	22A
55	50	15	22	25	22	MSO-2xN50KP MSO-2xN50CXKP ¹	MSO-2xN50	4 2	29A 35A
65	65	18.5	30	37	30	MSO-2xN65KP MSO-2xN65CXKP ¹	MSO-2xN65	4 2	15A, 22A, 29A, 35A, 42A, 54A
85	85	22	45	45	45	MSO-2xN80KP	MSO-2xN80	4 2	67A
105	105	30	55	55	55	MSO-2xN95KP	MSO-2xN95	4 2	82A 95A
125	120	37	60	60	60	MSO-2xN125KP	MSO-2xN125	4 2	
150	150	45	75	90	90	MSO-2xN150KP	MSO-2xN150	6 4	42A, 54A, 67A, 82A, 105A
180	180	55	90	110	110	MSO-2xN180KP	MSO-2xN180	6 4	125A
250	250	75	132	132	132	MSO-2xN220KP	MSO-2xN220	6 4	82A, 105A, 125A, 150A
300	300	90	160	160	200	MSO-2xN300KP	MSO-2xN300	6 4	180A, 210A
400	400	125	220	225	250	MSO-2xN400KP	MSO-2xN400	6 4	105A, 125A, 150A, 180A, 250A
									330A

Note: 1. "CX" denotes with finger protection terminal covers.



MSO-2xN11KP



MSO-2xN18

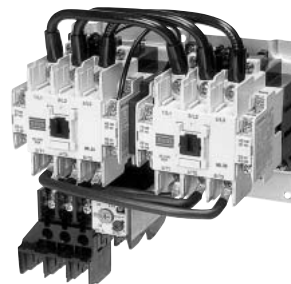

MSO-2xN35



MSO-2xN150KP

1.7.3 Enclosed Non-Reversing Motor Starters (IP 20)

Type MS-N□

Ordering Designation

Model name MS-N21KP
 Heater designation of overload relay 15A
 Main circuit voltage 220V
 Control circuit voltage and frequency 220V 50Hz

Complete type designation MS-N21KP*15A*220V*220V 50Hz

*Note: Mark*indicates a blank space.*

Table 1.7.3

Rated operational current AC-3		Rated motor capacity 3-phase AC-2 & AC-3				Model name		Free aux. contacts	Heater designation of overload relay
220 -240V (A)	380 -440V (A)	220 -240V (kW)	380 -440V (kW)	500V (kW)	690V (kW)	Phase failure protection type	Two heater type		(ordering designation)
11	9	2.5	4	4	4	MS-N10KP	MS-N10	— —	0.24A, 0.35A, 0.5A, 0.7A, 0.9A, 1.3A
13	12	3.5	5.5	5.5	5.5	MS-N11KP	MS-N11	— —	1.7A, 2.1A, 2.5A, 3.6A, 5A, 6.6A, 9A
13	12	3.5	5.5	5.5	5.5	MS-N12KP	MS-N12	— 1	11A
22	22	5.5	11	11	7.5	MS-N20KP	MS-N20	— 1	0.24A, 0.35A, 0.5A, 0.7A, 0.9A, 1.3A,
22	22	5.5	11	11	7.5	MS-N21KP	MS-N21	1 2	1.7A, 2.1A, 2.5A, 3.6A, 5A, 6.6A, 9A, 11A, 15A
30	30	7.5	15	15	11	MS-N25KP	MS-N25	1 2	22A
40	40	11	18.5	18.5	15	MS-N35KP	MS-N35	1 2	29A 35A
55	50	15	22	25	22	MS-N50KP	MS-N50	1 2	15A, 22A, 29A, 35A, 42A, 54A
65	65	18.5	30	37	30	MS-N65KP	MS-N65	1 2	
85	85	22	45	45	45	MS-N80KP	MS-N80	1 2	
105	105	30	55	55	55	MS-N95KP	MS-N95	1 2	
125	120	37	60	60	60	MS-N125KP	MS-N125	1 2	42A, 54A, 67A, 82A, 105A
150	150	45	75	90	90	MS-N150KP	MS-N150	1 2	125A
180	180	55	90	110	110	MS-N180KP	MS-N180	1 2	82A, 105A, 125A, 150A
250	250	75	132	132	132	MS-N220KP	MS-N220	1 2	
300	300	90	160	160	200	MS-N300KP	MS-N300	1 2	105A, 125A, 150A, 180A, 250A
400	400	125	220	225	250	MS-N400KP	MS-N400	1 2	

Note: 1. Models with finger protection terminal covers are not available.



MS-N10



MS-N21



MS-N65



MS-N220KP

1.7.4 Enclosed Non-Reversing Motor Starters with Pushbutton Switch (IP 20)

Type **MS-N□PM**

When the thermal overload relay is tripped, type MS-N□PM enclosed direct-on-line motor starters can be easily reset by pushing the OFF button on the enclosure (MS-N10 KPPM and -N11 KPPM can be reset by pushing the RESET button).

Ordering Designation

Model name MS-N21KPPM
 Heater designation of overload relay 15A
 Main circuit voltage 220V
 Control circuit voltage and frequency 220V 50Hz

*Note: Mark*indicates a blank space.*

Complete type designation **MS-N21KPPM*15A*220V*220V 50Hz**

Table 1.7.4

Rated operational current AC-3		Rated motor capacity 3-phase AC-2 & AC-3				Model name		Free aux. contacts		Heater designation of overload relay	
220 -240V (A)	380 -440V (A)	220 -240V (kW)	380 -440V (kW)	500V (kW)	690V (kW)	Phase failure protection type	Two heater type	1	2	(ordering designation)	
11	9	2.5	4	4	4	MS-N10KPPM	MS-N10PM	1	—	0.24A, 0.35A, 0.5A, 0.7A, 0.9A, 1.3A, 1.7A, 2.1A, 2.5A, 3.6A, 5A, 6.6A, 9A	
13	12	3.5	5.5	5.5	5.5	MS-N11KPPM	MS-N11PM	1	—	11A	
22	22	5.5	11	11	7.5	MS-N20KPPM	MS-N20PM	—	1	0.24A, 0.35A, 0.5A, 0.7A, 0.9A, 1.3A, 1.7A, 2.1A, 2.5A, 3.6A, 5A, 6.6A, 9A, 11A, 15A	
22	22	5.5	11	11	7.5	MS-N21KPPM	MS-N21PM	1	2	19A	
30	30	7.5	15	15	11	MS-N25KPPM	MS-N25PM	1	2	22A	
40	40	11	18.5	18.5	15	MS-N35KPPM	MS-N35PM	1	2	29A 35A	
55	50	15	22	25	22	MS-N50KPPM	MS-N50PM	1	2		
65	65	18.5	30	37	30	MS-N65KPPM	MS-N65PM	1	2	15A, 22A, 29A, 35A, 42A, 54A	
85	85	22	45	45	45	MS-N80KPPM	MS-N80PM	1	2	67A	
105	105	30	55	55	55	MS-N95KPPM	MS-N95PM	1	2	82A 95A	



MS-N11PM



MS-N80PMKP

1.8 Optional Parts and Accessories for Contactors

1.8.1 Replacement Coils

Table 1.8.1

AC operated coils				DC operated coils			
Contactors(s)	Part number*		Mass(kg)	Contactors(s)	Part number*		Mass(kg)
S-N10, S-N11, S-N12,	S-N10-COIL	AC □□□V	0.06	SD-N11, SD-N12,	SD-N11-COIL	DC □□□V	0.23
S-N18, SR-N4	SR-N4-COIL	AC □□□V		SRD-N4			
S-N20, S-N21	S-N21-COIL	AC □□□V	0.08	SD-N21	SD-N21-COIL	DC □□□V	0.24
S-N25, S-N35	S-N35-COIL	AC □□□V	0.08	SD-N35	SD-N35-COIL	DC □□□V	0.23
S-N50, S-N65	S-N50-COIL	AC □□□V	0.27	SD-N50, SD-N65	SD-N50-COIL	DC □□□V	0.8
S-N80, S-N95	S-N80-COIL	AC □□□V	0.6	SD-N80, SD-N95	SD-N80-COIL	DC □□□V	0.6
S-N125, S-N150	S-N125-COIL	AC □□□V	0.46	SD-N125, SD-N150	SD-N125-COIL	DC □□□V	0.9
S-N180, S-N220	S-N180-COIL	AC □□□V	0.6	SD-N220	SD-N220-COIL	DC □□□V	1.4
S-N300, S-N400	S-N300-COIL	AC □□□V	0.9	SD-N300, SD-N400	SD-N300-COIL	DC □□□V	2.0
S-N600, S-N800	S-N600-COIL	AC □□□V	2.0	SD-N600, SD-N800	SD-N600-COIL	DC □□□V	6.0

Note: When ordering, please specify the operating voltage according to Table 1.5.1~3.

1.8.2 Replacement Contact Kits

Table 1.8.2 (1)







Kits of main contacts for contactors	Contactor	Part number	Mass(kg)
 <p>PARTS BH739N300</p>	Kit consists of 3 moving contacts and 6 stationary contacts (include springs and spring supports also).	S-N10(CX)*, -N11(CX), -N12(CX) SD-N11(CX), -N12(CX)	PARTS BH719N300 0.03
		S-N18(CX) S-N20(CX), -N21(CX), SD-N21(CX) S-N25(CX) S-N35(CX) SD-N35(CX) S-N50(CX) SD-N50 S-N65(CX) SD-N65 S-N80 SD-N80 S-N95 SD-N95 S-N125 SD-N125 S(D)-N150 S-N180 S(D)-N220 S(D)-N300 S(D)-N400 S(D)-N600 S(D)-N800	PARTS BH729N300 0.05 PARTS BH739N300 0.05 PARTS BH749N300 0.07 PARTS BH749N301 0.07 PARTS BH749N303 0.07 PARTS BH759N300 0.11 PARTS BH759N302 0.11 PARTS BH759N301 0.11 PARTS BH759N303 0.11 PARTS BH769N300 0.1 PARTS BH769N302 0.1 PARTS BH769N301 0.1 PARTS BH769N303 0.1 PARTS BH779N300 0.1 PARTS BH779N301 0.1 PARTS BH789N300 0.2 PARTS BH799N300 0.4 PARTS BH799N301 0.4 PARTS BH609N300 0.8 PARTS BH609N301 0.8 PARTS BH619N300 2.5 PARTS BH619N301 2.5
 <p>BH769N300</p>			
 <p>B799N300</p>			

Table 1.8.2 (2)

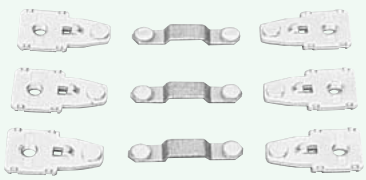
Kits of auxiliary contacts for contactors	Contactor	For arrangement	Part number	Mass(kg)	
 <p>PARTS BH719N310</p>	Kit consists of 1 bifurcated moving contact and 2 stationary contacts.	S-N10(CX), N11(CX), SD-N11(CX)	1NO PARTS BH719N310	0.01	
			1NC PARTS BH719N311	0.01	
 <p>PARTS BH729N310</p>	Kit consists of 2 bifurcated moving contacts and 4 stationary contacts.	S-N12(CX), SD-N12(CX)	1NO+1NC PARTS BH729N310	0.01	
		S-N20(CX)	1NO+1NC PARTS BH739N310	0.02	
 <p>PARTS BH739N311</p>	Kit consists of 4 bifurcated moving contacts and 8 stationary contacts.	S-N21(CX) to S-N35(CX),	2NO+2NC PARTS BH739N311	0.03	
		SD-N21(CX) to SD-N35(CX),			
		S-N50(CX) to N95	2NO+2NC PARTS BH539N315	0.02	
		SD-N50 to N95			
	S-N125, SD-N125	2NO+2NC PARTS BH579N312	0.02		
	S-N150 to N800	(Use auxiliary contact blocks, see 1.8.3 "Auxiliary Contact Blocks.")			
	SD-N150 to N800				

1.8.3 Auxiliary Contact Blocks

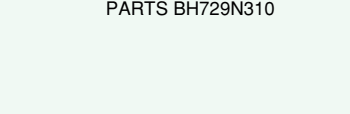
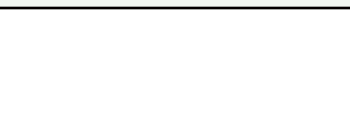
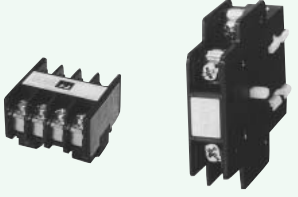
Table 1.8.3

	Mounting	Contactor/Relay	Type for	Contact arrangement	Part Number				
 <p>UN-AX4 UN-AX11</p>	Front clip-on ^{1,2}	S-N10(CX), -N11(CX), -N12(CX), -N20(CX), -N21(CX), -N25(CX), -N35(CX), -N18(CX), -N28(CX), -N38(CX), -N48(CX), -N50(CX), -N65(CX) SD-N11(CX), -N12(CX), -N21(CX), -N35(CX), -N50, -N65 SR-N4(CX) SRD-N4(CX)	Standard	2NO	UN-AX2(CX)2A				
				1NO+1NC	UN-AX2(CX)1A1B				
				2NC	UN-AX2(CX)2B				
				4NO	UN-AX4(CX)4A				
				3NO+1NC	UN-AX4(CX)3A1B				
				2NO+2NC	UN-AX4(CX)2A2B				
				Low level signal (5Vdc 5mA)	1NO+1NC (low level)	UN-LL22(CX)			
					1NO+1NC (standard)				
				 <p>UN-AX150</p>	Side clip-on ^{1,3}	S-N10(CX), -N11(CX), -N20(CX), -N21(CX), -N25(CX), -N35(CX) -N50(CX), -N65(CX) SD-N11(CX), -N21(CX), -N35(CX) -N50, -N65 SR-N4(CX), SRD-N4(CX)	Standard	1NO+1NC	UN-AX11(CX)
								Side clip-on ³	S(D)-N80, -N95, -N125
S(D)-N150, -N220, -N300, -N400, S-N180	1NO+1NC	UN-AX150							
S(D)-N600, -N800	2NO+2NC	UN-AX600							

Notes: 1 Front clip-on and side clip-on should not be mounted both.

2 Maximum 1 piece of aux. contact block can be mounted on a Contactor / Relay.

3 Maximum 2 pieces of aux. contact block can be mounted on a Contactor / Relay.

1.8.4 Mechanical Interlocks

Table 1.8.4

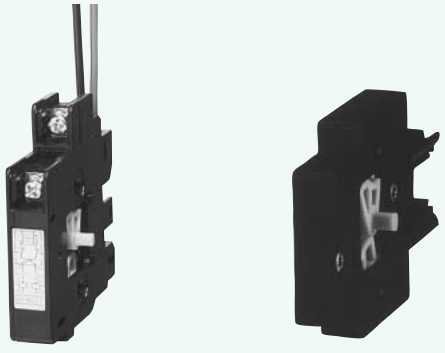
	Contactor	Part Number
 <p>UN-ML11 UN-ML21</p>	S-N10(CX), -N11(CX), SD-N11(CX)	UN-ML11(CX)
	S-N20(CX), -N21(CX), -N25(CX), -N35(CX), -N18(CX), -N28(CX), -N38(CX), -N48(CX), -N50(CX), -N65(CX)	UN-ML21
	SD-N21(CX), -N35(CX), -N50, -N65	
	S(D)-N80, -N95, -N125	UN-ML80
	S(D)-N150	UN-ML150
	S-N180, S(D)-N220, -N300, -N400	UN-ML220

1.8.5 Connecting Bar Kits

Table 1.8.5

	For connecting reversing contactors	Contactor	Part Number
 <p>UN-SD50</p>	Kit consists of 3 connecting bars or wires each for source and load side.	S-2×N10(CX), -2×N11(CX)	UN-SD10CX
		S-2×N18	UN-SD18CX
		S-2×N18CX	UN-SD18CX
		S-2×N20, -2×N21	UN-SD21CX
		S-2×N20CX, N2×N21CX	UN-SD21CX
		S-2×N25, -2×N35	UN-SD35CX
		S-2×N25CX, -2×N35CX	UN-SD35CX
		S-2×N50(CX), -2×N65(CX)	UN-SD50
		S-2×N80, -2×N95	UN-SD80
		S-2×N125	UN-SD125
		S-2×N150	UN-SD150
		S-2×N180, -2×N220	UN-SD220
		S-2×N300, -2×N400	UN-SD300
		S-2×N600, -2×N800	UN-SD600

1.8.6 Surge Absorbers

Table 1.8.6

	Contactor/Relay	Applicable control voltage	Part Number
 <p>UN-SA13</p>	Varistor type	S-N10, -N11, -N12, -N18, -N20, -N21, -N25, -N35, -N28, -N38, -N48 SD-N11, -N12, -N21, -N35, SR(D)-N4	AC24-240V/DC24-250V UN-SA21 AC200V AC200-480V UN-SA21 AC400V
	Varistor type with operating indicator (LED)	S-N10, -N11, -N12, -N18, -N20, -N21, -N25, -N35, -N28, -N38, -N48 SD-N11, -N12, -N21, -N35, SR(D)-N4	AC50-240V UN-SA22 AC200V DC60-250V
	Varistor and CR type	S-N10, -N11, -N18, -N20, -N21, -N25, -N35, -N28, -N38, -N48 SD-N11, -N12, -N21, -N35 SR(D)-N4	AC24-50V DC24-60V AC100-240V DC100-250V
CR type	S-N10, -N11, -N12, -N18, -N20, -N21, -N25, -N35, -N28, -N38, -N48, SR-N4 SD-N11, -N12, -N21, -N35, SRD-N4	AC24-240V DC24-250V	UN-SA23 AC200V UN-SA13 DC200V

1.8.7 Terminal Covers

Table 1.8.7

For contactors	Contactor	Part Number	For starters	Starter (loadside)	Part Number
 <p>S-N50 with 2pcs of UN-CZ500</p>	S(D)-N50, -N65 ³	UN-CZ500¹	MSO(D)-N50, -N65 ³	UN-CZ501²	(+CZ500)
	S(D)-N80, -N95	UN-CZ800¹	MSO(D)-N80, -N95	UN-CZ801²	(+CZ800)
	S(D)-N125	UN-CZ1250¹	MSO(D)-N125	UN-CZ1251²	(+CZ1250)
	S(D)-N150	UN-CZ1500¹	MSO(D)-N150	UN-CZ1501²	(+CZ1500)
	S-N180, S(D)-N220	UN-CZ2200¹	MSO-N180, MSO(D)-N220	UN-CZ2201²	(+CZ2200)
	S(D)-N300, -N400	UN-CZ3000¹	MSO(D)-N300, -N400	UN-CZ3001²	(+CZ3000)
	S(D)-2×N50, N65	UN-CZ502	MSO(D)-2×N50, N65	UN-CZ504	
	S(D)-2×N80, N95	UN-CZ802	MSO(D)-2×N80, N95	UN-CZ804	
	S(D)-2×N125	UN-CZ1252	MSO(D)-2×N125	UN-CZ1254	
	S(D)-2×N150	UN-CZ1502	MSO(D)-2×N150	UN-CZ1504	
	S-2×N180, S(D)-2×N220	UN-CZ2202	MSO-2×N180, MSO(D)-2×N220	UN-CZ2204	
	S(D)-2×N300, N400	UN-CZ3002	MSO(D)-2×N300, N400	UN-CZ3004	

Notes : 1. 2pcs are required for one contactor

2. For line side another cover (for contactor) is required.

3. Terminal covers should not be mounted for type S-N50CX, S-N65CX, MSO-N50(KP)CX and MSO-N65(KP)CX.

1.8.8 Pneumatic Time Delay Modules

Table 1.8.8

Contactor/Relay	On delay
S-N10(CX)	UN-TR4AN(CX)
S-N11(CX)	
S-N12(CX)	
S-N18(CX)	
SR-N4(CX)	
SD-N11(CX)	
SD-N12(CX)	
SRD-N4(CX)	

For detail see item 4.6.

Note : UN-AX11(CX) (Table 1.8.3) can not be combined to a Contactor / Relay together with UN-TR4AN (CX).

1.8.9 DC Interface Modules

Table 1.8.9

Direct mounting to contactor	Contactor/Relay	Solid state	Relay
 <p>UN-SY21</p>	S-N10(CX), -N11(CX), -N12(CX), -N18(CX), -N20(CX), -N21(CX), -N25(CX), -N35(CX), -N28(CX), -N38(CX), -N48(CX) SR-N4(CX)	UN-SY21(CX)	UN-SY22(CX)
	S-N50 S-N65	UN-SY31	UN-SY32
	S-N80 to N400	UN-SY11	UN-SY12

For detail see item 3.8.

1.9 Connections and Contact Arrangement

1.9.1 S, SD-N □

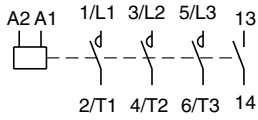

**S-N10, N11(1NO)
SD-N11(1NO)**

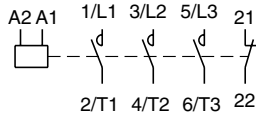

**S-N10, N11(1NC)
SD-N11(1NC)**

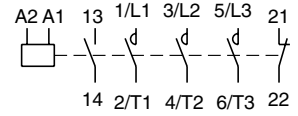

**S-N12, N20
SD-N12**

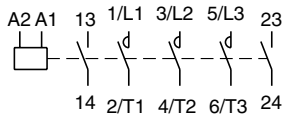

**S-N12(2NO)
S-N20(2NO)**

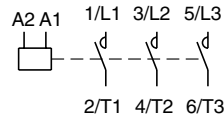

S-N18

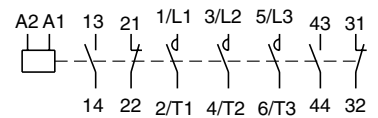

**S-N21, N25, N35
SD-N21, N35**

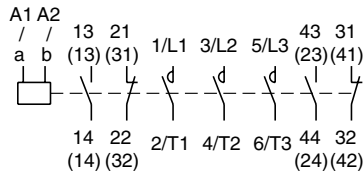

**S-N50~N400
SD-N50~N400**

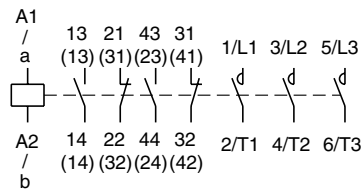

S-N600, N800

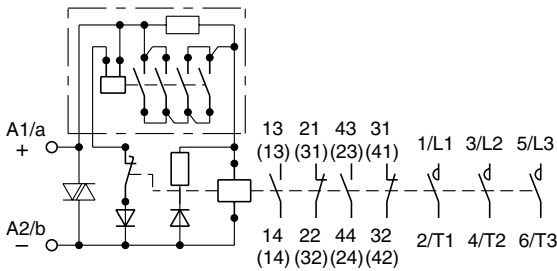

SD-N600, N800

1.9.2 S, SD-2xN □

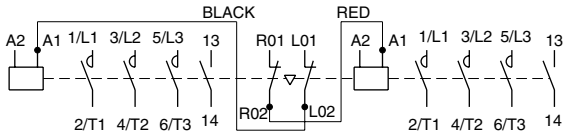

**S-2xN10, N11
SD-2xN11**

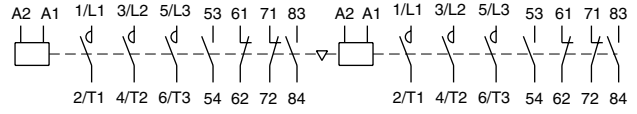

S-2xN18

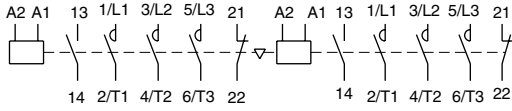

S-2xN20

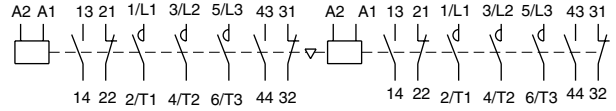

**S-2xN21~N35
SD-2xN21, N35**

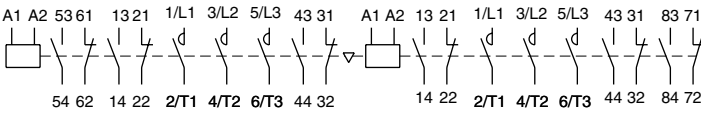

**S-2xN50~N400
SD-2xN50~N150, N220~N400**

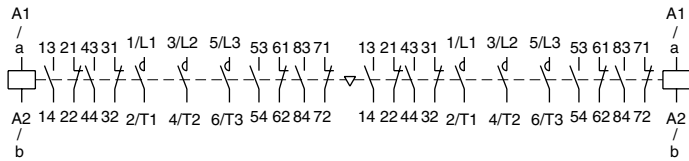

S-2xN600, N800

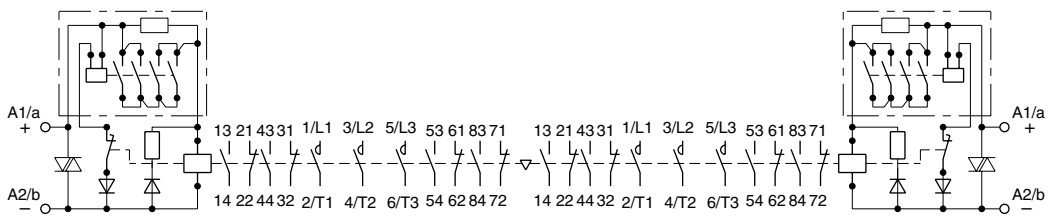

SD-2xN600, N800

1.9.3 SL, SLD-(2x)N □

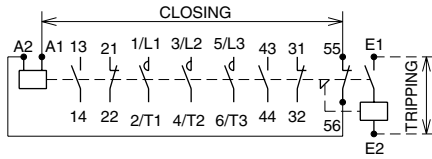

SL(D)-N21, N35

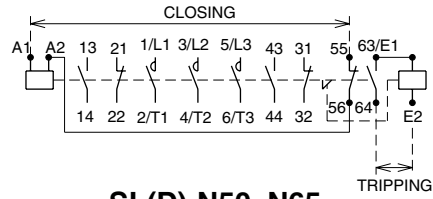

SL(D)-N50, N65

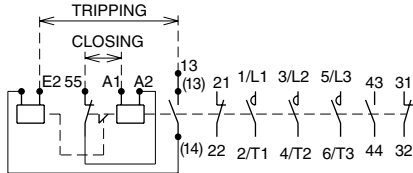

SL(D)-N80~N400

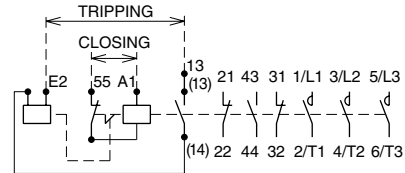

SL(D)-N600, N800

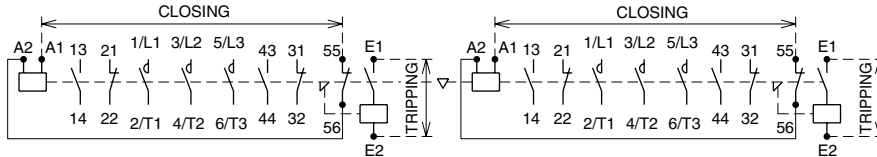

SL(D)-2xN21, N35

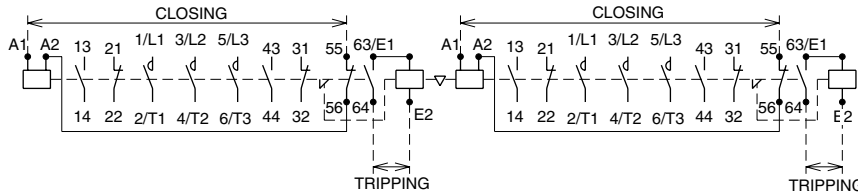

SL(D)-2xN50, N65

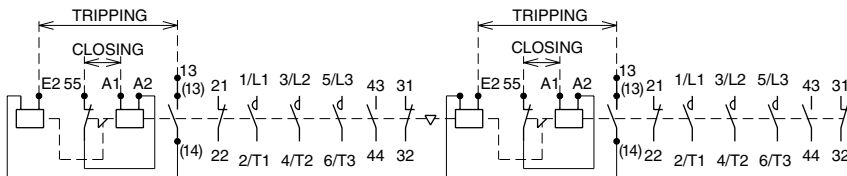

SL(D)-2xN80~N400

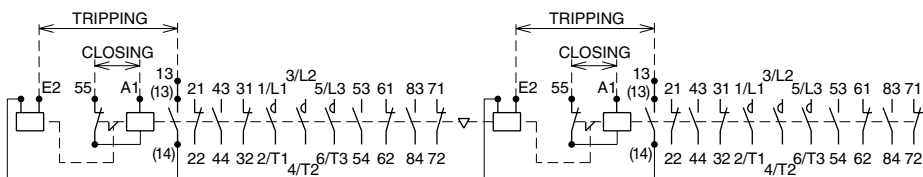

SL(D)-2xN600, N800

1.9.4 MSO-(2x)N □

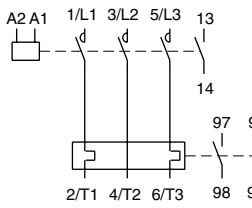

MSO-N10, N11

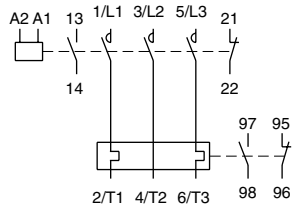

MSO-N12, N20

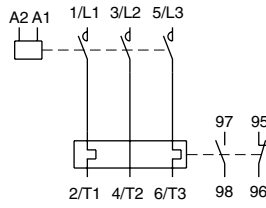

MSO-N18

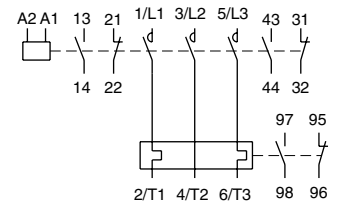

MSO-N21~N35

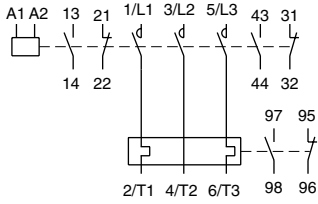

MSO-N50~N150

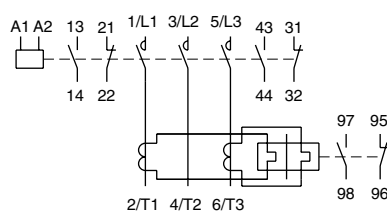

MSO-N180~N400

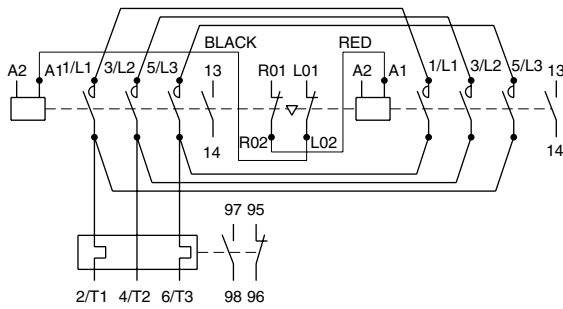

MSO-2xN10, N11

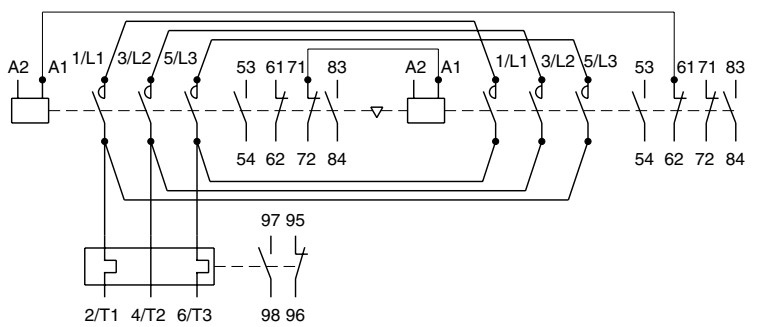

MSO-2xN18

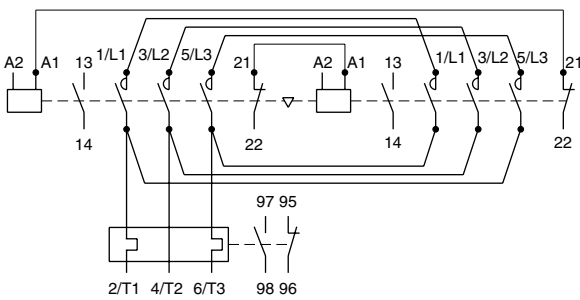

MSO-2xN20

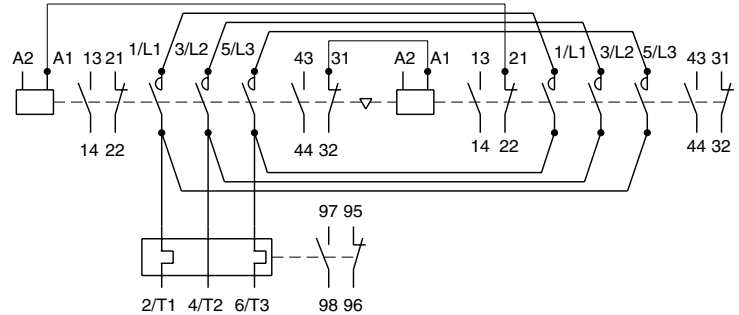

MSO-2xN21~N35

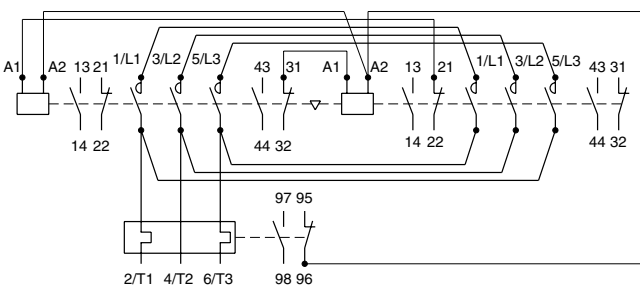

MSO-2xN50~N150

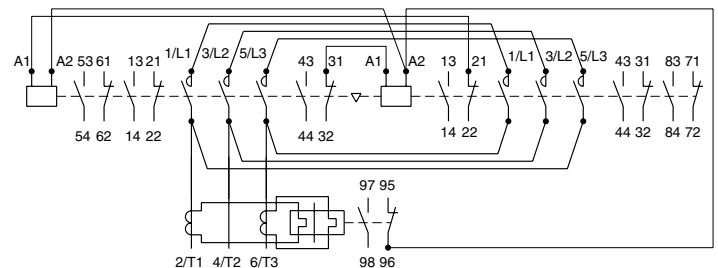

MSO-2xN180~N400

1.9.5 MS-N□

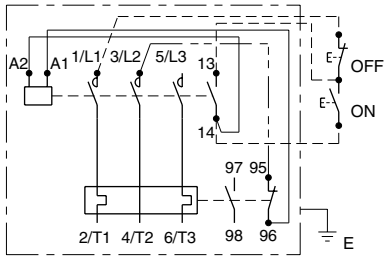

MS-N10, N11

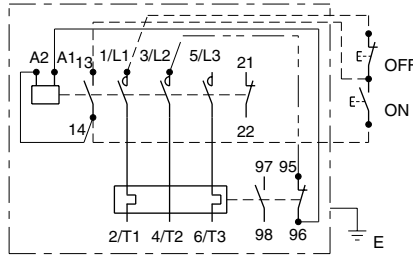

MS-N12, N20

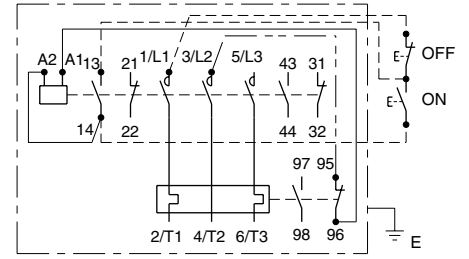

MS-N21, N35

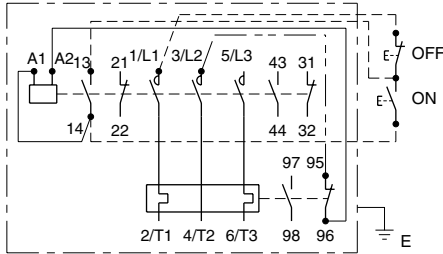

MS-N50~N150

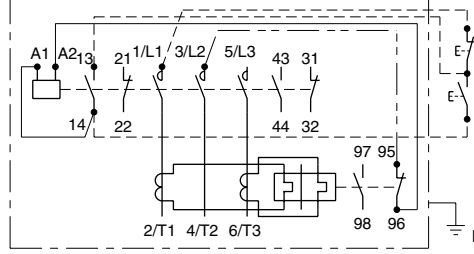

MS-N180~N400

Notes: 1. This shows the state when the same power is used for the main circuit and control circuit. The section shown with a solid line is already wired. The sections shown with a dashed line and a two points of chain line must be wired. (Use the wire enclosed with the product for the two points of chain line section.)

2. If the main circuit and control circuit power differ, do not connect a wire between the dashed line 1/L1-OFF button and the wire between the two points of chain line 3/L2-TH95. Wire to the OFF button and TH95 terminal from a different control circuit's power supply.

1.9.6 MS-N□PM

common control

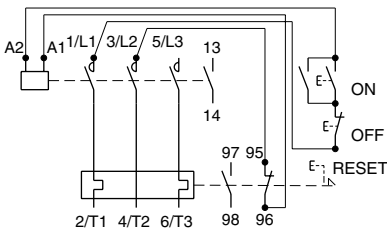

MS-N10, N11PM

common control

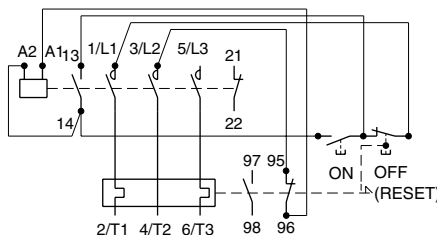

MS-N20PM

separate control

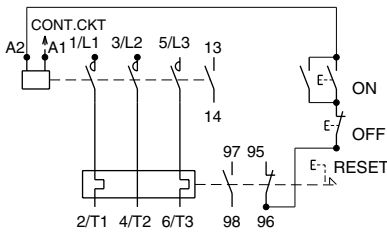

common control

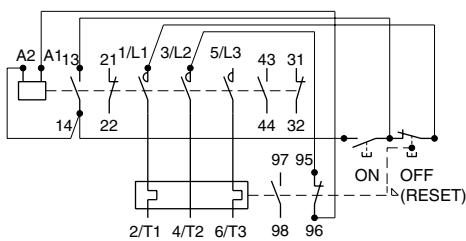

MS-N21~N35PM

separate control

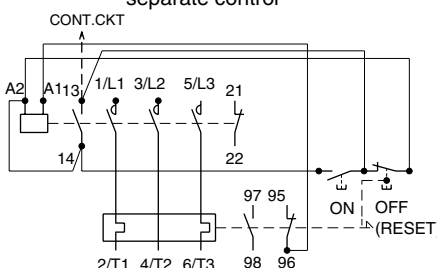

common control

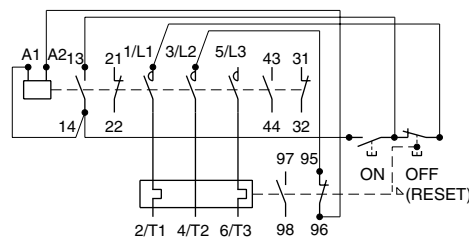

MS-N50~N95PM

separate control

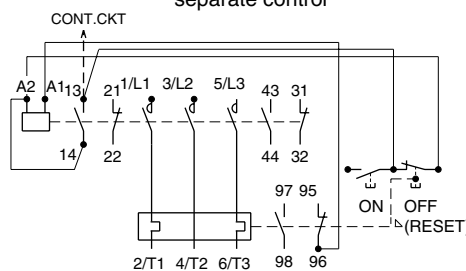

separate control

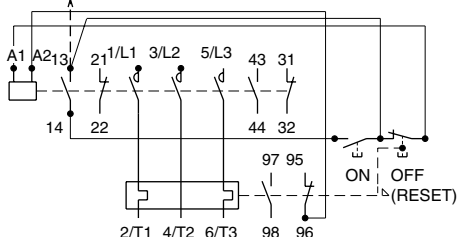

1.10 Outline Dimensions

1.10.1 Outline Dimensions of Non-Reversing Contactors

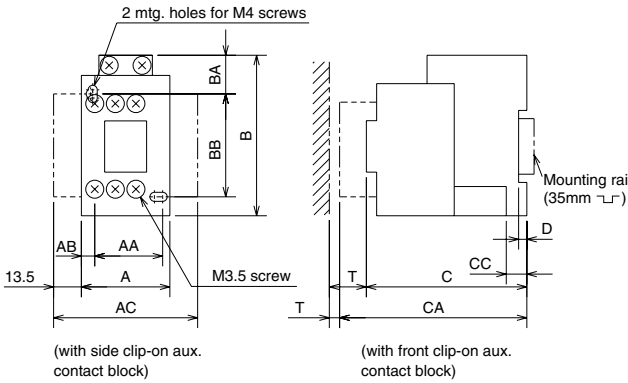

• Dimensions

Type	A	B	C	AA	AB	AC	BB	BA	CC	CA	D	Mass(kg)	T
S-N10(CX),-N11(CX)	43	78	78	35	4.5	70	50	19	10	106	4	0.3	5
S-N12(CX)	53	78	78	40	4.5	—	50	19	10	106	4	0.32	5
S-N18(CX)	43	79	81	30	6	—	60	13	10	109	4	0.33	5
SD-N11(CX)	43	78	110	35	4.5	70	50	19	10	138	4	0.62	5
SD-N12(CX)	53	78	110	40	4.5	—	50	19	10	138	4	0.64	5

Note: Front clip-on and side clip-on aux. contact blocks should not be mounted both.

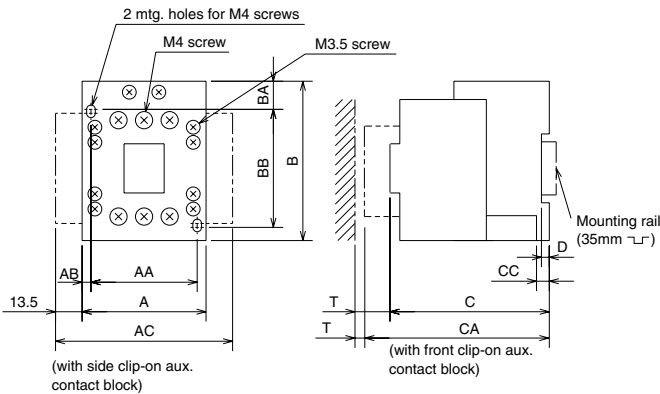

• Dimensions

Type	A	B	C	AA	AB	AC	BB	BA	CC	CA	D	Mass(kg)	T
S-N20(CX),-21(CX)	63	81	81	54	4.5	90	60	14	6.5	109	4	0.4	5
S-N25(CX),-N35(CX)	75	89	91	65	5	102	70	13	6.5	119	4	0.52	5
SD-N21(CX)	63	81	113	54	4.5	90	60	14	6.5	141	4	0.72	5
SD-N35(CX)	75	89	123	65	5	102	70	13	6.5	151	4	0.85	5
SLD-N21	63	81	137	54	4.5	90	60	14	6.5	—	4	0.55	5
SLD-N35	75	89	147	65	5	102	70	13	6.5	—	4	0.67	5

Note: Front clip-on and side clip-on aux. contact blocks should not be mounted both.

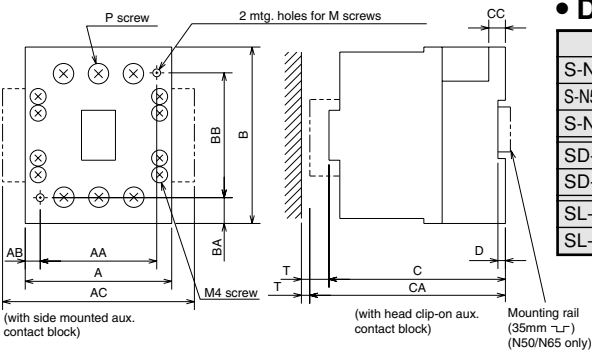

• Dimensions

Type	A	B	C	AA	AB	AC	BB	BA	CC	CA	D	M	P	Mass(kg)	T
S-N50,-N65	88	106	106	70	9	—	75	15.5	10	135	4.5	M4	M6	0.75	10
S-N50CX,-N65CX	88	108	106	70	9	—	75	15.5	10	135	4.5	M4	M6	0.77	10
S-N80,-N95	100	124	127	80	10	128	110	7	12	—	—	M5	M6	1.8	10
SD-N50,-N65	88	107.5	133	70	9	—	75	15.5	10	—	—	M4	M6	2.1	10
SD-N80,-N95	100	134	157	80	10	128	110	7	12	—	—	M5	M6	3.3	10
SL-N50,-N65	88	106	135.5	70	9	—	75	15.5	10	—	—	M4	M6	1.3	10
SL-N80,-N95	100	172	127	80	10	128	110	7	12	—	—	M5	M6	2.1	10

• Dimensions

Type	A	B	C	AA	AB	BB	BA	CC	CA	D	M	P	Mass(kg)	T
S-N125	100	150	137	90	5	125	12.5	1.6	—	—	M4	M8	2.5	10
S-N150	120	160	145	100	10	125	17.5	1.6	—	—	M5	M8	3.2	10
S-N180,-N220	138	204	175	120	9	190	7	1.6	—	—	M6	M10	5.5	10
S-N300,-N400	163	243	195	145	9	225	9	2.3	—	—	M8	M12	9.5	10
S-N600,-N800	290	310	235	250	20	250	30	10.5	—	—	M10	M16	27	10
SD-N125	102	150	162	90	5	125	12.5	1.6	—	—	M4	M8	4.3	30
SD-N150	120	160	169.5	100	10	125	17.5	1.6	—	—	M5	M8	4.3	30
SD-N220	138	204	200.5	120	9	190	7	2.0	—	—	M6	M10	7.5	30
SD-N300,-N400	163	243	221	145	9	225	9	2.3	—	—	M8	M12	13.5	50
SD-N600,-N800	375	310	235	250	20	250	30	10.5	—	—	M10	M16	28	10
SL(D)-N125	100	191	137	90	5	125	12.5	1.6	—	—	M4	M8	3.0	30
SL(D)-N150	120	201	145	100	10	125	17.5	1.6	—	—	M5	M8	3.6	30
SL(D)-N220	138	224	175	120	9	190	7	1.6	—	—	M6	M10	6.0	30
SL(D)-N300,-N400	163	259	195	145	9	225	9	2.3	—	—	M8	M12	10	50
SL(D)-N600,-N800	290	390	235	250	20	250	30	10.5	—	—	M10	M16	27	10

1.10.2 Outline Dimensions of Reversing Contactors

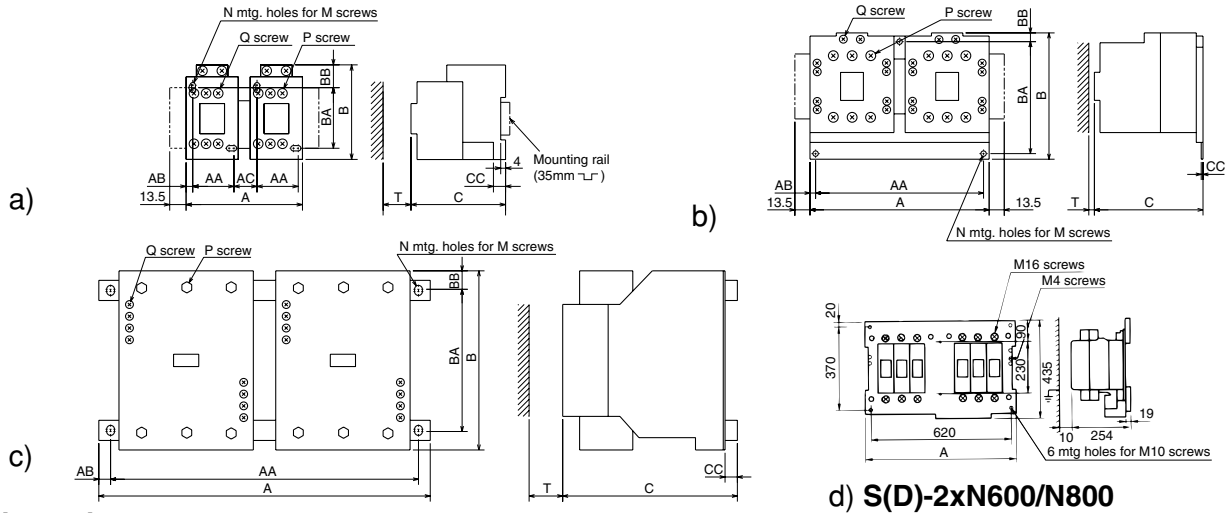

• Dimensions

Type	Fig.	A	B	C	AA	AB	AC	BA	BB	CC	N	M	P	Q	Mass(kg)	T
S-2xN10/N11	a	99	78	78	35	4.5	21	50	19	10	4	M4	M3.5	M3.5	0.64	5
S-2xN18	a	96	79	109	30	3.5	23	60	13	10	4	M4	M4	M3.5	0.75	5
S-2xN20/N21	a	136	81	81	54	4.5	19	60	14	6.5	4	M4	M4	M3.5	0.8	5
S-2xN25/N35	b	160	110	97	150	15	—	100	8	1.6	3	M4	M5	M3.5	1.3	5
S-2xN50/N65	b	216	115	112	204	6	—	100	8	2	3	M5	M6	M4	2.6	10
S-2xN80/N95	b	270	140	137	247	11.5	—	100	32	10	3	M6	M6	M4	4.3	10
S-2xN125	c	276	150	148	255	10.5	—	125	12.5	1.6	4	M6	M8	M4	5.7	30
S-2xN150	c	296	160	156	275	10.5	—	125	17.5	1.6	4	M6	M8	M4	7.2	30
S-2xN180/220	c	370	215	189	340	15	—	190	12.5	1.6	4	M8	M10	M4	12	30
S-2xN300/N400	c	395	250	209	365	15	—	225	12.5	2.3	4	M8	M12	M4	20.5	50
S-2xN600/N800	d	660	—	—	—	—	—	—	—	—	—	—	—	—	54	—
SD-2xN11	a	99	78	110	35	4.5	21	50	19	10	4	M4	M3.5	M3.5	1.3	5
SD-2xN21	b	160	100	119	150	5	—	90	5	2	3	M4	M4	M3.5	1.7	5
SD-2xN35	b	160	113	129	150	5	—	100	8	1.6	3	M4	M5	M3.5	2.0	5
SD-2xN50/N65	b	216	116.5	133	204	6	—	100	8	2	3	M5	M6	M4	4.5	10
SD-2xN80/N95	b	270	140	167	247	11.5	—	100	32	10	3	M6	M6	M4	6.4	10
SD-2xN125	c	276	150	173	255	10.5	—	125	12.5	1.6	4	M6	M8	M4	9.2	30
SD-2xN150	c	296	160	180.5	275	10.5	—	125	17.5	1.6	4	M6	M8	M4	10	30
SD-2xN220	c	370	215	214.5	340	15	—	190	12.5	1.6	4	M8	M10	M4	17	30
SD-2xN300/N400	c	395	250	235	365	15	—	225	12.5	2.3	4	M8	M12	M4	29	50
SD-2xN600/N800	d	800	—	—	—	—	—	—	—	—	—	—	—	—	64	—

Latched Contactors (Reversing)

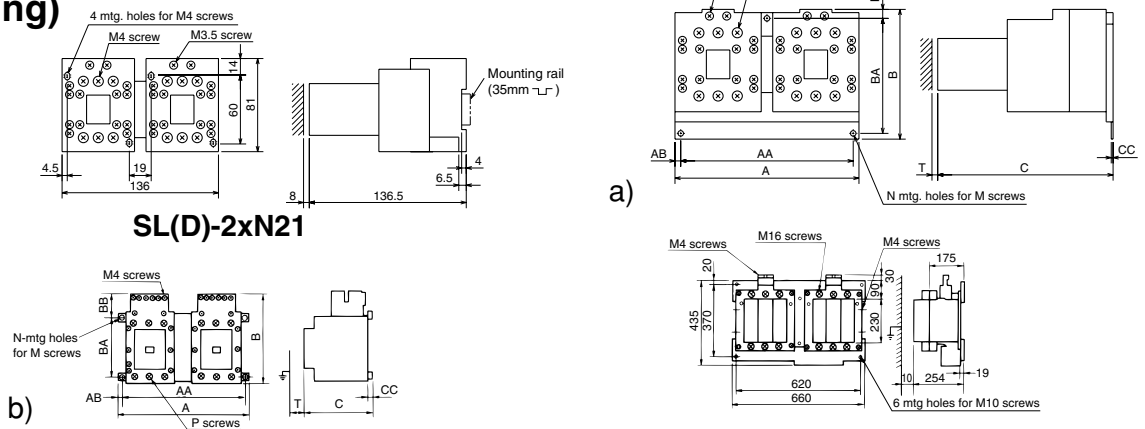

• Dimensions

Type	Fig.	A	B	C	AA	AB	BA(BC)	BB	CC	N	M	P	Q	Mass(kg)	T
SL(D)-2xN35	a	160	113	153	150	5	100	8	1.6	3	M4	M5	M3.5	2.2	5
SL(D)-2xN50/N65	a	216	115	141.5	204	6	100	8	2	3	M5	M6	M4	3.2	10
SL(D)-2xN80/N95	b	270	184	137	247	11.5	100	74	10	3	M6	M6	M4	5.3	10
SL(D)-2xN125	b	276	191	148	255	10.5	125	53.5	11	4	M6	M8	M4	6.7	30
SL(D)-2xN150	b	296	201	156	275	10.5	125	58.5	11	4	M8	M8	M4	8.8	30
SL(D)-2xN220	b	370	230	189	340	15	190	27	14	4	M8	M10	M4	13	30
SL(D)-2xN300/N400	b	395	263	209	365	15	225	25	14	4	M8	M12	M4	21.5	50

1.10.3 Outline Dimensions of Open Type Starters

■ Nonreversing Starters without Enclosures

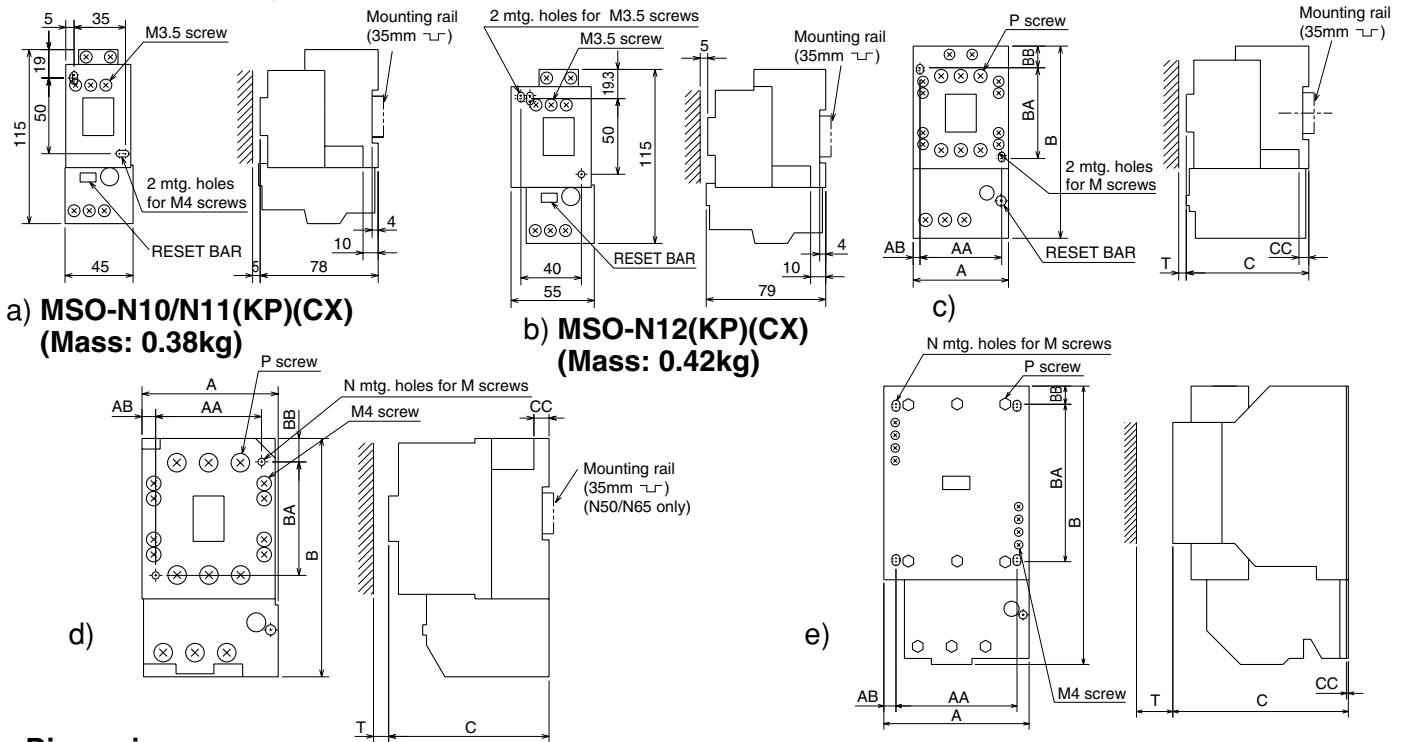

• Dimensions

Type	Fig.	A	B	C	AA	AB	BA	BB	CC	N	M	P ¹	Mass(kg)	T
MSO-N18(CX)(KP)	c	54	122	81	30	7	60	13	10	2	M4	M4(M3.5)	0.5	5
MSO-N20(CX)(KP)	c	63	127	81	54	4.5	60	14	6.5	2	M4	M4(M3.5)	0.6	5
MSO-N21(CX)(KP)	c	63	127	81	54	4.5	60	14	6.5	2	M4	M4(M3.5)	0.6	5
MSO-N25/N35(CX)(KP)	c	75	157	91	65	5	70	13	6.5	2	M4	M5(M3.5)	0.8	5
MSO-N50/N65(KP)	d	90	158	106	70	9	75	16	10	2	M4	M6	2.2	10
MSO-N50/N65(CX)(KP)	d	92	160	106	70	9	75	18	10	2	M4	M6	2.3	10
MSO-N80/N95(KP)	d	100	196	127	80	10	110	7	12	2	M5	M6	3.2	10
MSO-N125(KP)	e	112	239	137	90	14	125	12.5	1.6	4	M4	M8	4.2	30
MSO-N150(KP)	e	120	250	145	100	10	125	17.5	1.6	4	M5	M8	7.7	30
MSO-N180/N220(KP)	e	144	282	180.5	120	12	190	7	1.6	4	M6	M10	7.7	30
MSO-N300/N400(KP)	e	163	358	195	145	9	225	9	2.3	4	M8	M12	12.5	50

Note: 1. Value in parenthesis shows terminal screw of coil and auxiliary contact.

■ Reversing Starters without Enclosures

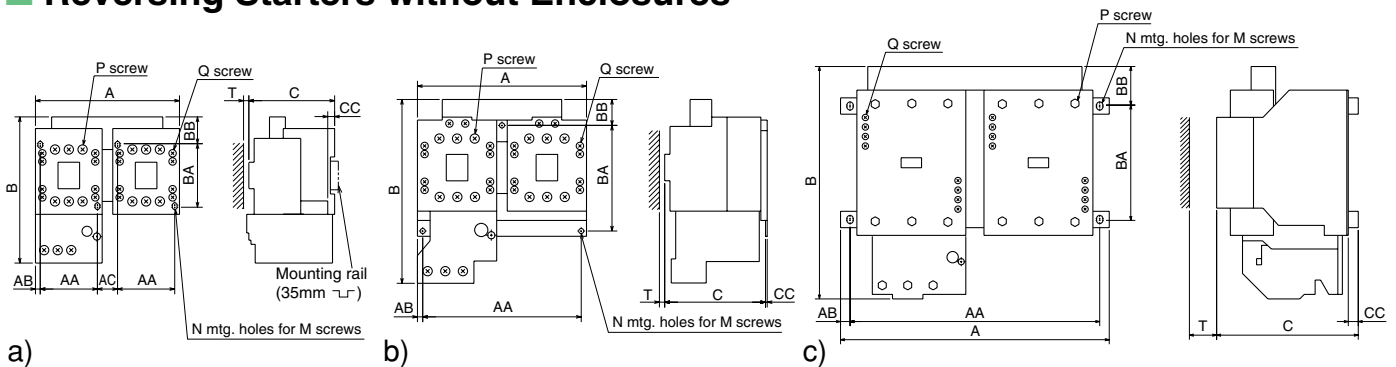

• Dimensions

Type	Fig.	A	B	C	AA	AB	AC	BA	BB	CC	N	M	P	Q	Mass(kg)	T
MSO-2xN10/N11(CX)(KP)	a	99	125	79	35	4.5	21	50	19	10	4	M4	M3.5	M3.5	0.76	5
MSO-2xN18(CX)(KP)	a	97	134	109	30	6.5	23	60	13	10	4	M4	M4	M3.5	0.9	5
MSO-2xN20/N21(CX)(KP)	a	136	138	81	54	4.5	19	60	14	6.5	4	M4	M4	M3.5	1.0	5
MSO-2xN25/N35(CX)(KP)	b	160	159	97	150	5	—	100	8	1.6	3	M4	M5	M3.5	1.3	5
MSO-2xN50/N60(CX)(KP)	b	216	169	112	204	6	—	100	17	2	3	M5	M6	M4	2.9	10
MSO-2xN80/N95(KP)	b	270	213	137	247	11.5	—	100	45.5	10	3	M6	M6	M4	4.6	10
MSO-2xN125(KP)	c	276	251	148	255	10.5	—	125	24.5	11	4	M6	M8	M4	6.6	30
MSO-2xN150(KP)	c	296	276	156	275	10.5	—	125	43.5	11	4	M6	M8	M4	8.5	30
MSO-2xN180/N220(KP)	c	370	304	194.5	340	15	—	190	28.5	14	4	M8	M10	M4	14.5	30
MSO-2xN300/N400(KP)	c	395	392	209	365	15	—	225	42.5	14	4	M8	M12	M4	24.5	50

1.10.4 Outline Dimensions of Enclosed Motor Starters

■ Nonreversing Starters with Enclosures

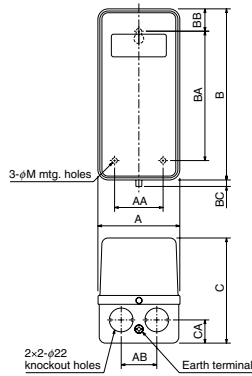

MS-N10(KP)-N21(KP)

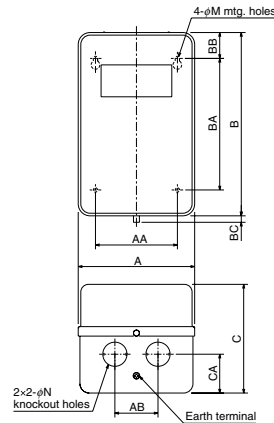

MS-N25(KP)-N400(KP)

• Dimensions

Type	A	AA	AB	B	BA	BB	BC	C	CA	M	N	Mass(kg)
MS-N10/K11(KP)	76	45	33	159	120	21	6	97.5	21.5	4	22	0.8
MS-N12(KP)	76	45	33	159	120	21	6	97.5	21.5	5	22	0.9
MS-N20(KP)/N21(KP)	104	76	50	170	140	15	6	110	30	6	22	1.1
MS-N25(KP)/N35(KP)	135	95	50	225	165	30	6	126	45	6	28	2.0
MS-N50(KP)	160	120	80	270	220	25	12	145	45	6	22 × 35	3.2
MS-N65(KP)	160	120	80	270	220	25	12	145	45	6	22 × 35	3.2
MS-N80/N95(KP)	190	150	100	300	260	20	12	163	67	7	22 × 35	4.0
MS-N125(KP)	230	170	90	384	330	29	12	190	80	9	44 × 50	8.0
MS-N150(KP)	270	200	120	484	400	44	12	209	85	9	44 × 50	12.8
MS-N180/N220(KP)	270	200	120	484	400	44	12	209	85	9	44 × 50	16.2
MS-N300/N400(KP)	440	320	160	590	480	55	12	220	140/90*	11	62 × 78	28

* Left value is for power-supply side, right for load side.

■ Enclosed Type Nonreversing Starters with Pushbuttons

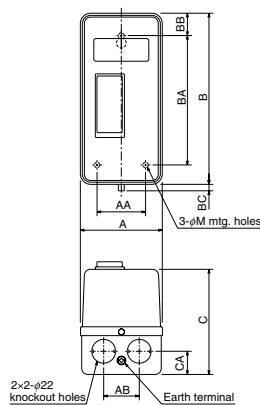

MS-N10PM(KP)-N21PM(KP)

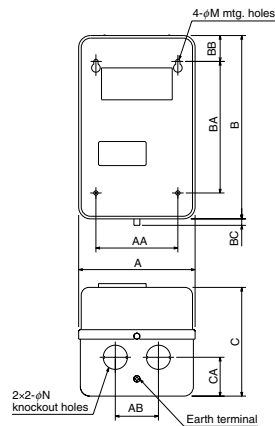

MS-N25PM(KP)-N95PM(KP)

• Dimensions

Type	A	AA	AB	B	BA	BB	BC	C	CA	M	N	Mass(kg)
MS-N10/N11PM(KP)	76	45	33	159	120	21	6	114	22	4	22	0.9
MS-N20PM(KP) MS-N21PM(KP)	104	76	50	170	140	15	6	114	30	6	22	1.3
MS-N25/N35PM(KP)	135	95	50	225	165	30	6	130	45	6	28	2.1
MS-N50/N65PM(KP)	160	120	80	270	220	25	12	149	45	6	22 × 35	3.3
MS-N80/N95PM(KP)	190	150	100	300	260	20	12	167	67	7	22 × 35	4.1

2. MOTOR PROTECTION RELAYS

2.1 Thermal Overload Relays

TH-N Series Thermal Overload Relays Will Make a Convenience and Safer Systems.



TH-N12



TH-N20



TH-N12CX

A Selection of Relays for Optimum Motor Protection Characteristics

The thermal relay line-up includes two-element units as well as the phase failure protection type models (three-element relays), all with the same external dimensions.

This array of protection characteristics allows you to choose the units best suited to your motor protection needs.

Maintenance and Inspection Are Easy

An operation indicator makes maintenance and inspection easy. Checks can be performed using manual operations.

1NO + 1NC Contacts

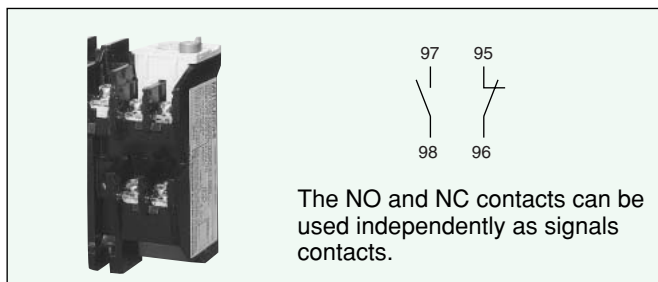

• Display and External Trip Mechanism

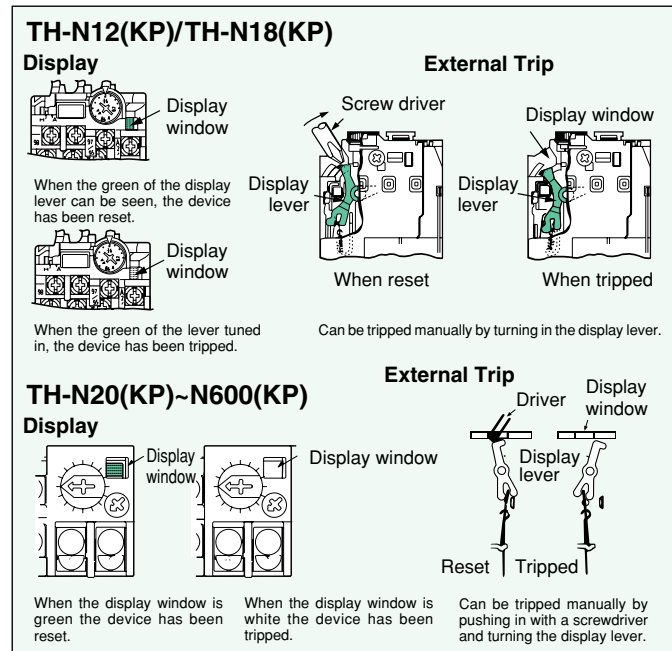

Rated Current Can Be Set Easily

The value of the rated current is displayed on a dial. Simply adjust the dial to the full-load current of the motor and motor protection is assured.

Finger Protectors

Models with finger protectors that conform to DIN VDE 0106 Part 100 (TH-N□CX) are also available.

Various Accessories

- Independent mount adaptor for TH-N12(CX) : UN-HZ12(CX)
- Reset release : UN-RR□□□
- Trip indicating LED : UN-TL□□

Trip-Free Reset Bar

Choose between automatic and manual reset. Also features tripfree reset bar mechanism.

• Switching Between Automatic and Manual Reset

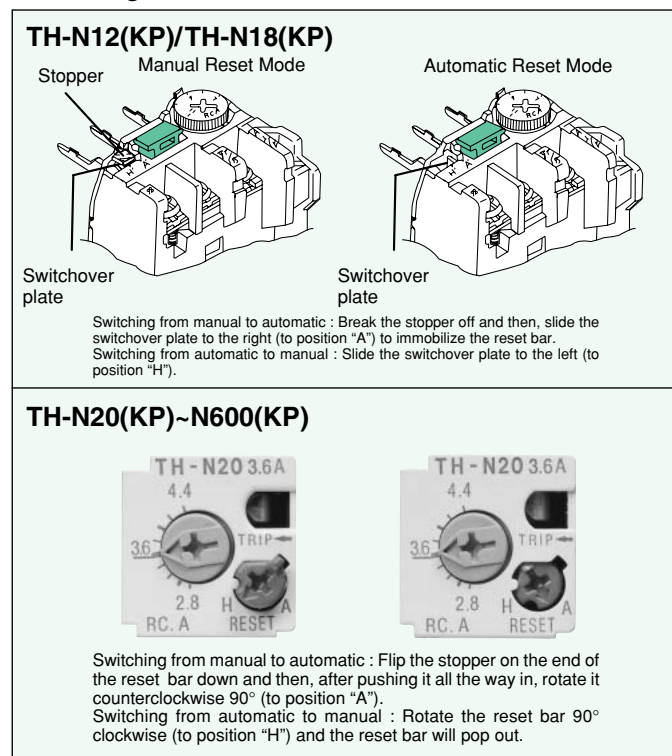

Table 2.1.1

2.1.1 Selection Guide of Thermal Overload Relays

Max. Fuse Rating (660Vac) IEC 269-1 (A)			Overload Relay			Motor Capacity [kW, (hp)] (Three phase 50/60Hz, based on four poles)			
aM	gG	gM	Heater designation	Setting range (A)	Model (TH-)	AC220-240V	AC380V	AC400-440V	AC500V
0.5	0.5	—	0.12A	0.1-0.16	N12	—	—	—	—
0.5	1	—	0.17A	0.14-0.22		—	—	—	—
1	2	—	0.24A	0.2-0.32		0.03(1/24)	0.06(1/12)	0.06(1/12)	0.09(1/8)
1	2	—	0.35A	0.28-0.42		0.05(1/16)	0.09(1/8)	0.09(1/8)	0.12(1/6)
1	2	—	0.5A	0.4-0.6		0.06(1/12)	0.12(1.6)	0.12(1.6)	0.18(1/4)
2	4	—	0.7A	0.55-0.85		0.09(1/8)	0.18(1/4)	0.18(1/4)	0.25(1/3)
2	4	—	0.9A	0.7-1.1		0.12(1/6)	0.25(1/3)	0.25(1/3)	0.37(1/2)
2	4	—	1.3A	1.0-1.6		0.18(1/4)	0.37(1/2)	0.37(1/2) 0.55(3/4)	0.55(3/4)
4	6	—	1.7A	1.4-2.0		0.25(1/3)	0.55(3/4)	0.75(1)	0.75(1)
4	6	—	2.1A	1.7-2.5		0.37(1/2)	0.75(1)	—	1.1(1-1/2)
6	10	—	2.5A	2.0-3.0		0.55(3/4)	1.1(1-1/2)	1.1(1-1/2)	1.5(2)
6	10	—	3.6A	2.8-4.4		0.75(1)	1.5(2)	1.5(2)	2.2(3)
8	16	—	5A	4.0-6.0	1.1(1-1/2)	2.2(3)	2.2(3)	3(4)	
12	20	—	6.6A	5.2-8.0	1.5(2)	3(4)	3,3.7(4.5)	3.7(5)	
12	20	—	9A	7.0-11	2.2(3)	3.7(5) 4(5-1/2)	3(4) 3.7(5)	5.5(7-1/2)	
16	25	32M35	11A	9.0-13	3(4)	5.5(7-1/2)	5.5(7-1/2)	7.5(10)	
20	32	32M50	15A	12-18	3.7(5)	7.5(10)	7.5(10) 9(12.5)	9(12/5)	
25	40	32M63	19A ¹	16-22	5.5(7-1/2)	11(15)	11(15)	11(15)	
40	63	32M63	22A	18-26	5.5(7-1/2)	11(15)	11(15)	15(20)	
50	80	63M80	29A	24-34	7.5(10)	15(20)	15(20)	18.5(25)	
63	80	63M80	35A ²	30-40	9(12.5)	18.5(25)	18.5(25)	22(30)	
63	100	100M100	42A	34-50	11(15)	22(30)	22(30)	30(40)	
80	125	100M125	54A	43-65	15(20)	30(40)	30(40)	37(50)	
100	160	100M160	67A	54-80	18.5(25)	37(50)	37(50)	45(60)	
125	200	100M200	82A	65-100	22(30)	45(50)	45(60)	55(75)	
—	200	100M200	95A ³	85-105	30(40)	55(75)	55(75)	—	
—	250	200M250	105A	85-125	30(40)	55(75)	55(75)	75(100)	
—	250	200M250	125A	100-150	37(50)	75(100)	75(100)	90(125)	
—	315	200M315	150A	120-180	45(60)	90(125)	90(125)	110(150)	
—	400	—	180A	140-220	55(75)	110(150)	110(150)	132(175)	
—	500	—	210A ⁴	170-250	75(100)	132(180)	132(180)	—	
—	630	—	250A	200-300	75(100)	132(180) 160(220)	132(180) 160(220)	160(220)	
—	630	—	330A	260-400	90(125) 110(150)	200(270)	200(270)	220(300) 250(340)	
—	800	—	500A	400-600	132(180) 160(220)	220(300) 250(340) 300(400)	220(300) 250(340) 300(400)	400(530)	
—	1000	—	660A	520-800	200(270) 220(300)	400(530)	400(530)	500(670)	

Notes: 1. For starter size N20, N21 only. 2. For starter size N35 only. 3. For starter size N95 only. 4. For starter size N220 only. 5. Selection by mounting

Mounting	W/o F/P (2)	TH-N12(KP)	TH-N18(KP)	TH-N20(KP)	TH-N20TA(KP)	TH-N60(KP)	TH-N60TA(KP)	TH-N120(KP)	TH-N120TA(KP)	TH-N220RH(KP)	TH-N400RH(KP)	—
Contactor mounting	With F/P (3)	TH-N12CXKP	TH-N18CXKP	TH-N20CXKP	TH-N20TAKPCX	TH-N60CXKP	—	—	—	—	—	—
Independent mounting	W/o F/P (2)	TH-N12(KP) + UN-HZ12 ⁽⁴⁾	—	TH-N20(KP)	—	TH-N60(KP)	—	TH-N120(KP)	TH-N120TAHZ(KP)	TH-N220HZ(KP)	TH-N400HZ(KP)	TH-N600(KP) + CT
	With F/P (3)	TH-N12CXKP + UN-HZ12CX ⁽⁴⁾	—	TH-N20CXHZKP	—	TH-N60CXKP	—	—	—	—	—	—

Notes: 1. Use "Connecting parts" when couple with contactor (see Table 2.1.6(3)). 2. W/o F/P: Without Finger Protection. 3. With F/P: With Finger Protection. 4. UN-HZ12(CX) is shipped separately from TH-N12(CX)(KP). 5. CT should be supplied by customer.

2.1.2 Selection Guide of the Current Transformers for TH-N600KP

Table 2.1.2

Current Transformer for TH-N600KP	Heater Designation(A)		250	330	500	660
	Setting Range(A)		200~300	260~400	400~600	520~800
	Current Transformer Ratio		400/5A	500/5A	750/5A	1,000/5A
	Current Transformer Capacity		At least 15VA			
	Recommended MITSUBISHI Current Transformer Model Number		Cable wiring	CW-15L 400/5A 15VA	CW-15L 500/5A 15VA	CW-15L 750/5A 15VA
		Bus bar wiring	CW-15LM 400/5A 15VA	CW-15LM 500/5A 15VA	CW-15LM 750/5A 15VA	CW-40LM 1000/5A 40VA

* Current transformer to be supplied by customer.

2.1.3 Technical Data

Table 2.1.3

Three heater type Two heater type	TH- TH-	N12(CX)KP N12(CX)	N18(CX)KP N18(CX)	N20(CX)KP N20(CX)	N20TA(CX)KP N20TA(CX)	N60(CX)KP N60(CX)	N60TAKP N60TA	N120KP N120	N120TAKP N120TA	N220RHKP N220RH	N400RHKP N400RH	N600KP N600	
Max. setting current	A	13	18	22	40	65	105	100	150	220	400	800	
Range of setting current	A	0.1-13	2.8-18	0.2-22	18-44	12-65	54-105	34-100	85-150	65-250	85-400	200-800	
Rated insulation voltage	V	690	690	690	690	690	690	690	690	1000	1000	690	
Permissible ambient temperature	°C	-25 to +55											
Single phase protection		Types TH-N□□□KP provide the protection.											
Bimetal heating		Direct									Via CTs		Via CTs ¹
Max. heater dissipation per current path													
Min. setting	W	0.8	0.9	0.8	1.4	1.7	2.4	2.5	3.2	2.5	2.5	2.5	
Max. setting	W	1.8	2.2	2.2	3.5	4.9	5.2	7.1	8.6	6.0	6.0	6.0	
Auxiliary contact		1NO + 1NC											
Rated operating current of aux. contacts													
Category	NO	2						2					
AC-15	contact	120V	A					1					
		240V	A	1									
		500V	A	0.5						0.5			
NC	contact	120V	A	2								3	
		240V	A	1								2	
		500V	A	0.5								1	
Category	48V	A	0.4								0.5		
DC-13		110V	A	0.2								0.2	
		220V	A	0.1								0.1	
Main terminal screw size													
Line side	mm	—		M4	M4	M6	M6	M8	M8	—	—	M4	
Load side	mm	M3.5	M4	M4	M5	M6	M6	M8	M8	M10	M12	M4	
Standard wire sizes recommended		0.24A-2	3.6A-2	0.24A-2	22A-5.5	15A-3.5	67A-22	42A-14	105A-60	—	—	—	
Heater designation-wire size	(mm ²)	11A-2	11A-2 15A-3.5	11A-2 15A-3.5 19A-3.5	29/35A-8	22A-5.5 29/35A-8 42A-14 54A-22	82/95A-38	54/67A-22 82A-38	125A-60	—	—	—	
Max. conductor size													
Main	Line side	mm ²	(2.5) ²	—	6	—	25	—	38	60	—	—	6
	Load side	mm ²	2.5	6	6	16	25	38	38	60	150	240	6
Busbar width	Line side	mm	—	—	—	—	15	—	20	20	—	—	—
	Load side	mm	—	—	—	—	15	20	20	20	25	30	—
Aux. contacts	mm ²	2.5		4	4	4	4	4	4	4	4	4	

Notes: 1. Used with current transformer (to be supplied by the customer). See Table 2.1.2.
2. When used with UN-HZ 12(CX) adaptor.

2.1.4 Selection Guide of Quick Trip Thermal Overload Relay

Table 2.1.4

Applicable contactor	S-N10 S-N11 S-N12	S-N20 S-N21 S-N25 S-N35	S-N25 S-N35	S-N50 S-N65 S-N80 S-N95	S-N80 S-N95
Three heater type with phase failure protection	TH-N12KF	TH-N20KF	TH-N20TAKF	TH-N60KF	TH-N60TAKF
Two heater type	—	TH-N20FS	TH-N20TAFS	TH-N60FS	TH-N60TAFS
Heater setting range (Ordering designation)	1.7~2.5(2.1A) 2.8~4.4(3.6A) 4~6(5A) 5.2~8(6.6A) 7~11(9A) 9~13(11A)	1.7~2.5(2.1A) 2.8~4.4(3.6A) 4~6(5A) 5.2~8(6.6A) 7~11(9A) 9~13(11A) 12~18(15A)	18~26(22A) 24~34(29A) 30~40(35A) ¹	34~50(42A) 43~65(54A)	54~80(67A) 65~93(82A) ²

Notes: *1. Only for S-N35.
*2. Only for S-N95.

2.1.5 Operating Characteristics of Thermal Overload Relays

(Connecting wire size: Refer to “standard wire size” of Table 2.1.3)

TH-N12
TH-N12KP·TH-N12SR

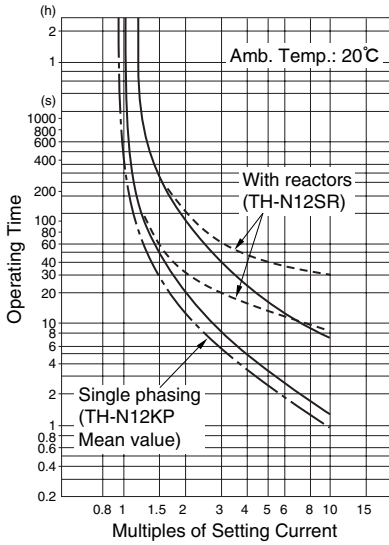

TH-N18
TH-N18KP

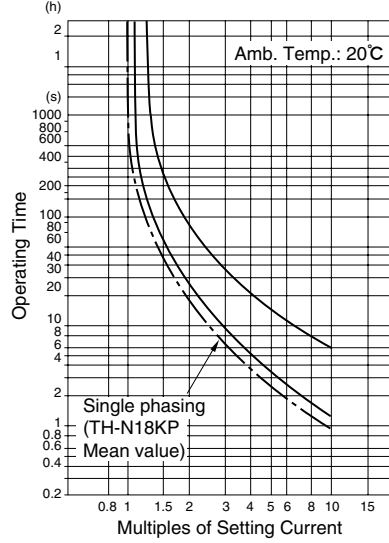

TH-N20·TH-N20KP
TH-N20SR·TH-N20KPSR

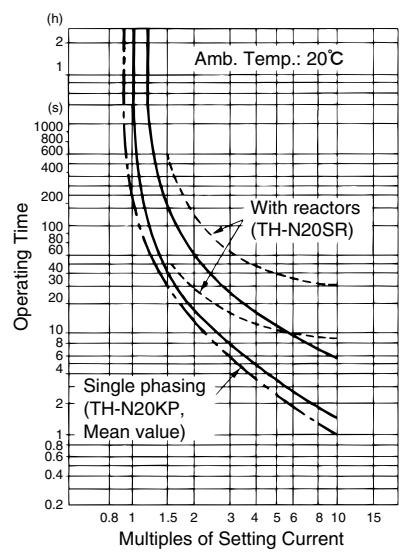

TH-N20TA·TH-N20TAKP
TH-N20TASR·TH-N20TAKPSR

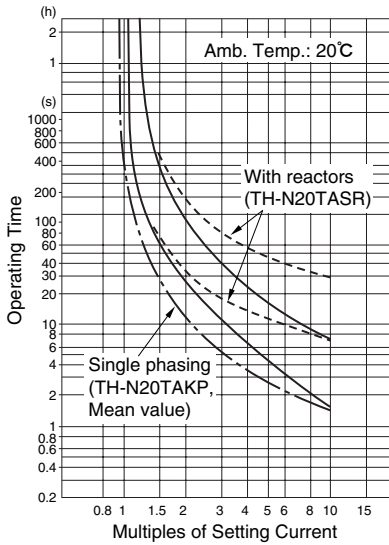

TH-N60·TH-N60TA
TH-N60KP·TH-N60TAKP
TH-N60SR·TH-N60TASR
TH-N60KPSR·TH-N60TAKPSR

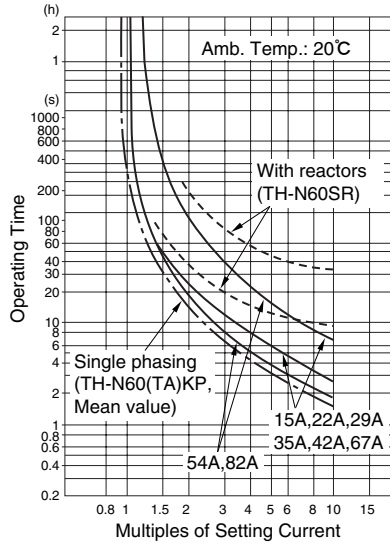

TH-N120·TH-N120KP
TH-N120SR·TH-N120KPSR
TH-N120TA·TH-N120TAKP
TH-N120TASR·TH-N120TAKPSR

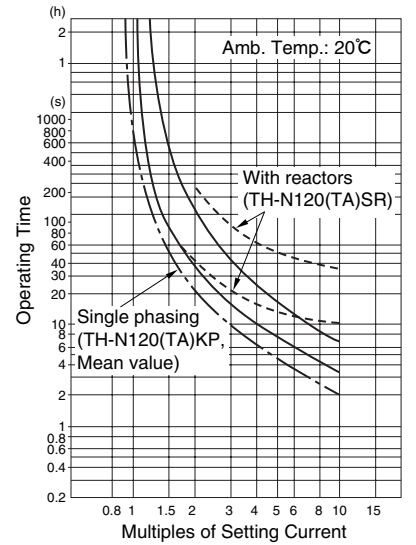

TH-N220RH
TH-N220RHKP
TH-N220RHSR
TH-N220RHKPSR
TH-N400RH
TH-N400RHKP
TH-N400RHSR
TH-N400RHKPSR

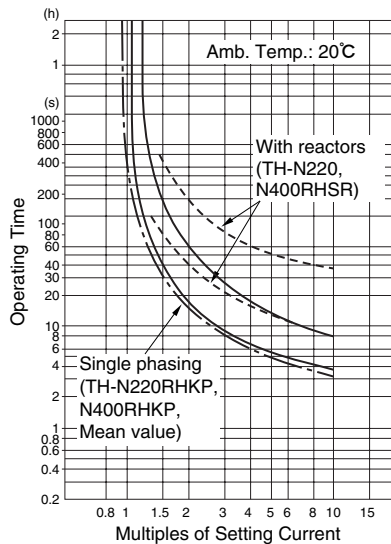

TH-N600
TH-N600KP
TH-N600SR
TH-N600KPSR

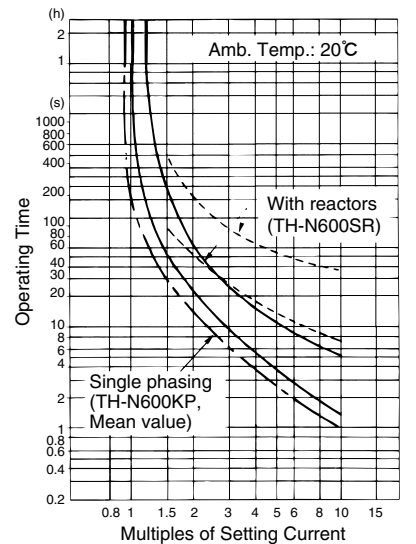

2.1.6 Optional Parts and Accessories

Saturable Reactors for Slow Tripping

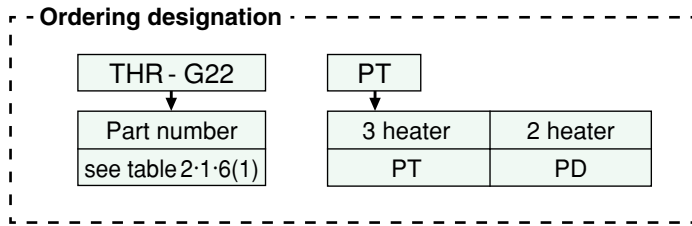

Table 2.1.6 (1)

Heater Designation	Part number						
	TH-N12 ¹	TH-N20(KP)	TH-N20TA(KP)	TH-N60(KP) TH-N60TA(KP)	TH-N120(KP) TH-N120TA(KP)	TH-N220□□(KP) TH-N400□□(KP)	TH-N600(KP)
0.24A	TSR-A0Y	TSR-C0Y	—	—	—	—	—
0.35A	TSR-A0Y	TSR-C0Y	—	—	—	—	—
0.5A	TSR-A01	TSR-C0Y	—	—	—	—	—
0.7A	TSR-A03	TSR-C03	—	—	—	—	—
0.9A	TSR-A05	TSR-C03	—	—	—	—	—
1.3A	TSR-A09	TSR-C07	—	—	—	—	—
1.7A	TSR-A11	TSR-C09	—	—	—	—	—
2.1A	TSR-A12	TSR-C10	—	—	—	—	—
2.5A	TSR-A13	TSR-C12	—	—	—	—	—
3.6A	TSR-A15	TSR-C15	—	—	—	—	—
5A	TSR-A18	TSR-C17	—	—	—	—	—
6.6A	TSR-A21	TSR-C20	—	—	—	—	—
9A	TSR-A23	TSR-C23	—	—	—	—	—
11A	TSR-A25	TSR-C25	—	—	—	—	—
15A	—	TSR-C26	—	THR-G22	—	—	—
19A	—	TSR-C29	—	—	—	—	—
22A	—	—	TSR-D28	THR-G24	—	—	—
29A	—	—	TSR-D29	THR-G26	—	—	—
35A	—	—	TSR-D28	THR-G27	—	—	—
41A	—	—	—	THR-G27	THR-H41	—	—
54A	—	—	—	THR-G29	THR-H42	—	—
67A	—	—	—	THR-G29	THR-H43	—	—
82A	—	—	—	THR-G30	THR-H43	THR-F10	—
95A	—	—	—	THR-G30	—	—	—
105A	—	—	—	—	THR-H44	THR-F13	—
125A	—	—	—	—	THR-H45	THR-F13	—
150A	—	—	—	—	—	THR-F15	—
180A	—	—	—	—	—	THR-F16	—
210A	—	—	—	—	—	THR-F17	—
250A	—	—	—	—	—	THR-F18	THR-E13
330A	—	—	—	—	—	THR-F19	THR-E13
500A	—	—	—	—	—	—	THR-E13
660A	—	—	—	—	—	—	THR-E13

Note: 1. Saturable reactors can be adopted only for the two heater type TH-N12

Table 2.1.6 (2)

Trip indicator	Thermal overload relay	Voltage(50/60Hz)	Part number
	TH-N12(CX)(KP)	AC 24/DC24V	UN-TL15DC24V
	TH-N18(CX)(KP)	AC 100-127V AC 200-240V	UN-TL15AC100V UN-TL15AC200V
Reset release	Thermal overload relay	Part number	Length (mm)
	TH-N12(CX)(KP)	UN-RR205	200
	TH-N18(CX)(KP)	UN-RR405 UN-RR555 UN-RR705	400 550 700
Separate mounting adaptor	Thermal overload relay	Part number	
	TH-N12(TP/KP)	UN-HZ12	
	TH-N12CX(TP/KP)	UN-HZ12CX	

Note: 1. Except for type TH-N60CX and TH-N60CXKP.

• Connecting Parts for Contactors to Thermal Overload Relays

Table 2.1.6 (3)

	For connection between contactor (non-reversing type) and thermal overload relay		Overload relay	Contactor	Part number	Mass(kg)
				TH-N20(CX)(KP)	S-N20(CX), S(D)-N21(CX)	UN-TH21(CX)
			TH-N20(CX)(KP), -N20TA(CX)(KP)	S-N25(CX), S(D)-N35(CX)	UN-TH25(CX)	0.02
			TH-N60(CX)(KP)	S-N50(CX), -N65(CX) SD-N50, -N65	BH559N350	0.02
			TH-N60(KP), -N60TA(KP)	S-N80, -N95 SD-N80, -N95	BH569N350 BH569N352	0.04 0.04
			TH-N120(KP), N120TA(KP)	S(D)-N125 S(D)-N150	BH579N355 BH589N355	0.36 0.36

* Connecting bars and mounting plate are included in the OLR of TH-N220RH(KP) and TH-N400RH(KP) for S-N180, -N220, -N300, -N400.

2.1.7 Outline Dimensions

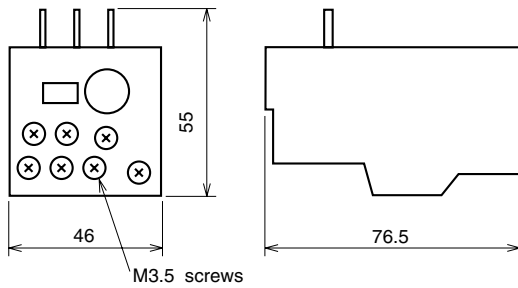

TH-N12(CX)(KP) (Mass: 0.11kg)

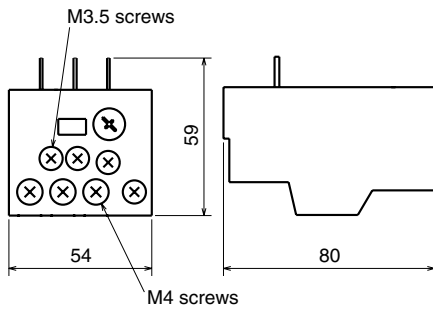

TH-N18(CX)(KP) (Mass: 0.14kg)

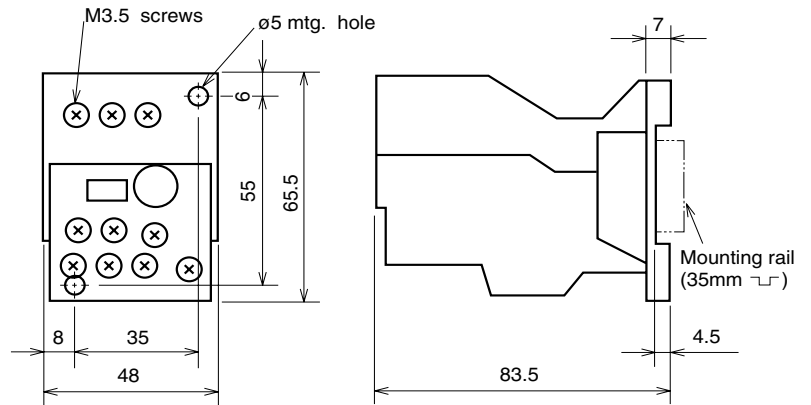
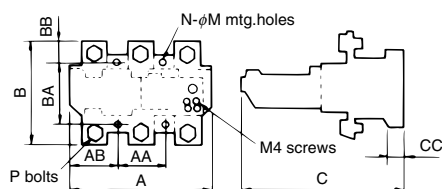
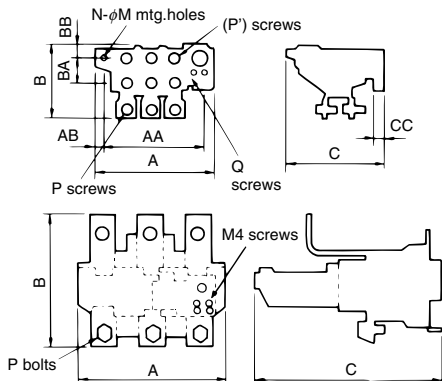
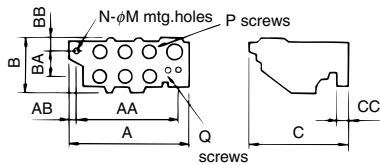

TH-N12(CX)(KP) with mounting adapter UN-HZ12(CX)

Type	A	B	C	AA	AB	BA	BB	CC	N	M	P	Q	Mass (kg)
TH-N20(CX)(KP)	63	51	79	19	15	33	8.5	7	2	4.5	M4	M3.5	0.14
TH-N60(KP)	91.5	57	87	70	12	45	6	9	2	4.5	M6	M4	0.28
TH-N60CX(KP)	91.5	57	87	70	12	45	6	9	2	4.5	M6	M4	0.28
TH-N120(KP)	103	67	105	75	14	50	6	10	2	6	M8	M4	0.48
TH-N600(KP)	63	42	83.5	19	14	33	2	7	2	4.5	M4	M4	0.14

Type	A	B	C	AA	AB	BA	BB	CC	N	M	P(Ĥ)	Q	Mass (kg)
TH-N20TA(CX)(KP)	74	72	83.5	—	—	—	—	—	—	—	M5 (M4)	M3.5	0.2
TH-N60TA(KP)	89	73.5	83.5	—	—	—	—	—	—	—	M6 (M6)	M4	0.32
TH-N120TA(KP)	112	87	105	—	—	—	—	—	—	—	M8 (M8)	M4	0.75
TH-N120TAHZ(KP)	112	103	105	75	25	50	25	10	2	6	M8 (M8)	M4	1.0

Type	A	B	C	AA	AB	BA	BB	CC	N	M	P	Mass (kg)
TH-N220RH(KP)	144	114	179.5	—	—	—	—	—	—	—	M10	2.5
TH-N400RH(KP)	144	160	193.5	—	—	—	—	—	—	—	M12	2.7

Type	A	B	C	AA	AB	BA	BB	CC	N	M	P	Mass (kg)
TH-N220HZ(KP)	144	104	166.5	47	48.5	62	21	18	4	6	M10	2.5
TH-N400HZ(KP)	144	173	166.5	47	48.5	62	55.5	18	4	6	M12	2.7

Note: Suffix "HZ" denotes separate mounting type.

2.2 Electronic Motor Protection Relays

Series ET-N



ET-N60 60A

The MITSUBISHI series ET-N relay is an excellent relay that can protect motors electrically. Those series ET-N relays have the following excellent features.

■ Features

- Selectable Protection Mode
 - Overload (including locked rotor condition)
 - Phase failure (including current unbalance)
 - Incorrect phase sequence
- Excellent Wide Current Range
- Easy Wiring
- Easy Setting and Maintainance
- Selectable Tripping Time at 600% of setting.
 - Quick trip (3s.)
 - Fast trip (5s.)
 - Medium trip (15s.)
 - Slow trip (30s.)
- Withstands High Overcurrent
- Fine Indication of Trip Mode
- Conformity to International Standards
- Can be mounted on 35mm rail (ET-N60)

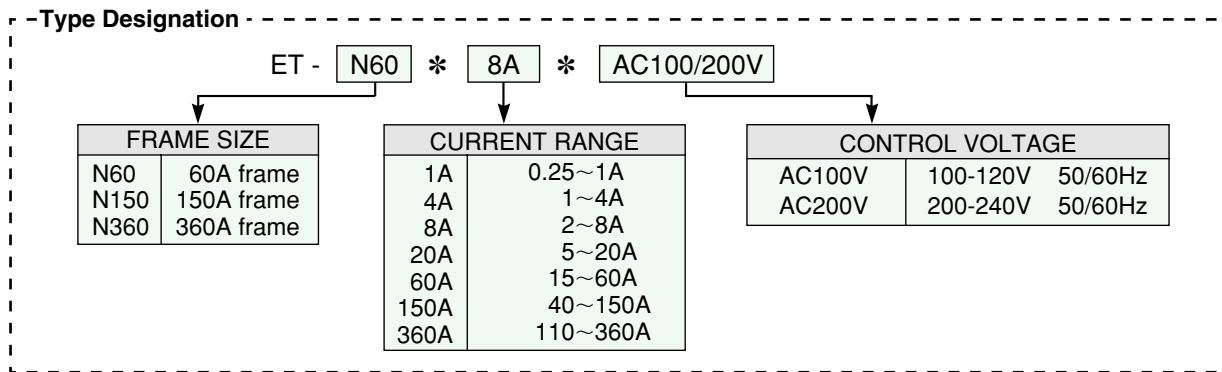

■ Specifications

• Ratings and characteristics

Table 2.2.1

Frame size [Current range]		N60[1A]	N60[4A]	N60[8A]	N60[20A]	N60[60A]	N150[150A]	N360[360A]	
Rated insulation voltage	VAC	690							
Adjustable setting range	A	0.25-1	1-4	2-8	5-20	15-60	40-150	110-360	
Applicable motor capacity	200-240VAC	kW	0.03-0.2	0.2-0.75	0.4-1.5	1.5-4	3.7-11	11-37	30-90
	380-440VAC	kW	0.05-0.4	0.4-1.5	0.75-2.2	2.2-7.5	7.5-22	22-75	55-150
3-ph	200-240VAC	HP	1/16-1/4	1/4-1	1/2-2	2-5	5-15	15-50	40-125
	380-440VAC	HP	1/8-1/2	1/2-2	1-3	3-10	10-30	30-100	75-200
Rated operating current of aux. contacts	Category 120VAC	A	2						
	AC-15 240VAC	A	1						
Rated operating current of aux. contacts	Category 24VDC	A	1						
	DC-13 110VDC	A	0.2						
Permissible ambient temperature/humidity	°C/%RH	-10 to +55/45 to 85							
Control circuit consumption	VA	7.5 (AC100V)/15 (AC200V)							
Control voltage tolerance	times	0.85 to 1.1 (rated control voltage)							
Tripping time		See Fig. 2.2.1							
Tripping condition	Overload	%	[minimum tripping current] 110 to 120 (at setting current)						
	Phase failure	%	more than 70 (at setting current) [Tripping time : 2-4 sec.]						
	Reversal phase	%	more than 70 (at setting current) [Tripping time : less than 0.5 sec.]						
Withstand voltage	VAC	2500 [1 minute]							
Shock resistance	Vibration 10-55Hz	m/s ²	19.6						
	Sine wave pulse	m/s ²	49						
Conductor size	Main terminals	mm ²	2-14			3.5-22	5.5-60	14-200	
	Control terminals	mm ²	1.25-2						

Note: ET-N relay cannot be used on DC circuit

• Characteristic Curves

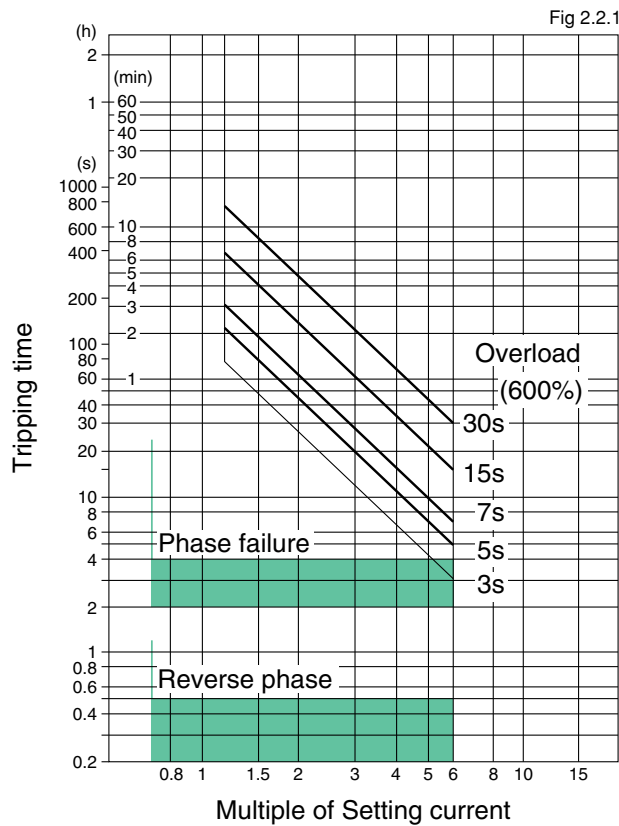

• Selection of Protection Mode & Tripping Time

Table 2.2.2

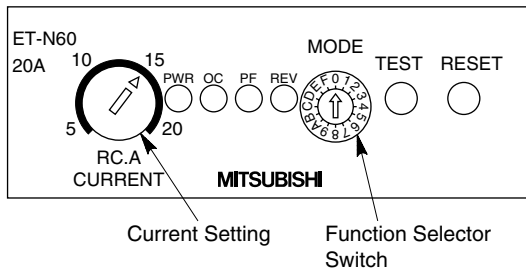

The selector switch is set at position "7" (overload and phase failure protection mode; standard trip type) when shipping. So please reset the position of the changeover switch according to Table 2.2.2 before installation.

Protection mode	Overload tripping time at 600% of setting(s)	Symbol on changeover switch
Overload, phase failure and reversal phase [3E]	3	0
	5	1
	7	2
	15	3
	30	4
Overload and phase failure [2E]	3	5
	5	6
	7	7
	15	8
Overload only [1E]	30	9
	3	A
	5	B
	7	C
	15	D
	30	E

• Application to High Voltage or Big Motor Circuit

The high voltage current transformer (secondary current: smaller than 5A; capacity: more than 5VA) should be connected to ET-N60*8A in the star connection, when the load is high voltage or big AC motor.

■ Wiring Precautions

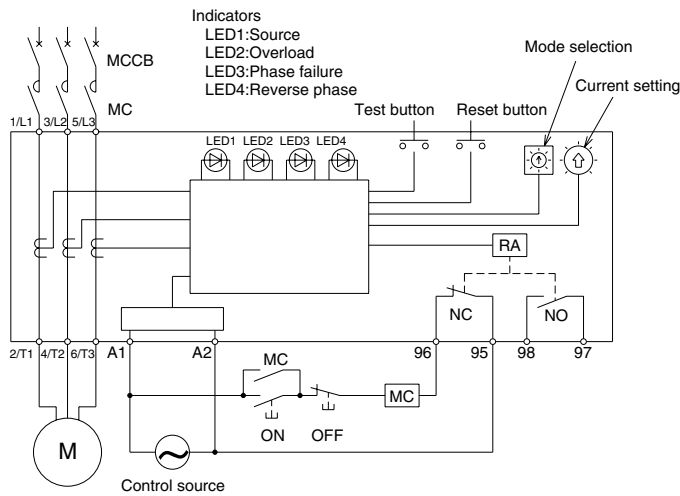

- The control source should be wired in the same phases as the contactor control source.
- When the load is a single phase motor, use 1/ L1-2/T1 and 5/L3-6/T3 phases. And re-set the position of changeover switch to "A" to "E".

- If capacitors are used to correct the power factor, connect the capacitor in the power source side of the ET-N relay.

■ Outline Dimensions

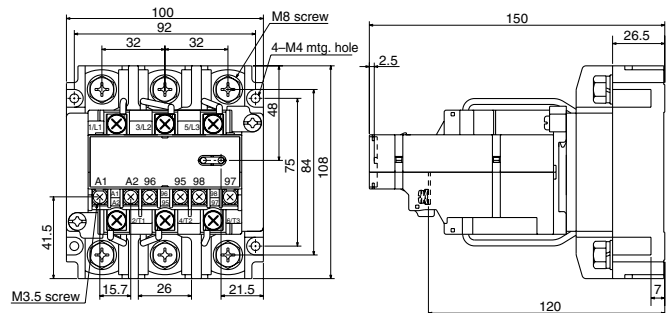
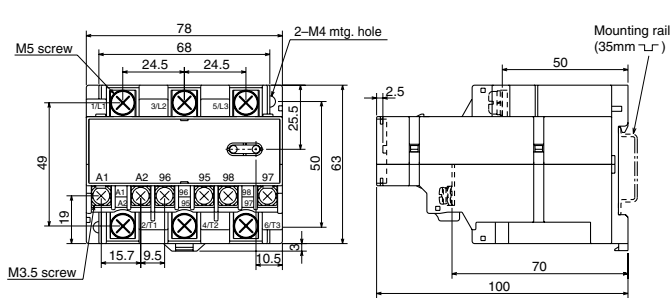

ET-N60(1-60A) (Mass: 0.3kg)

ET-N150 (Mass: 1.6kg)

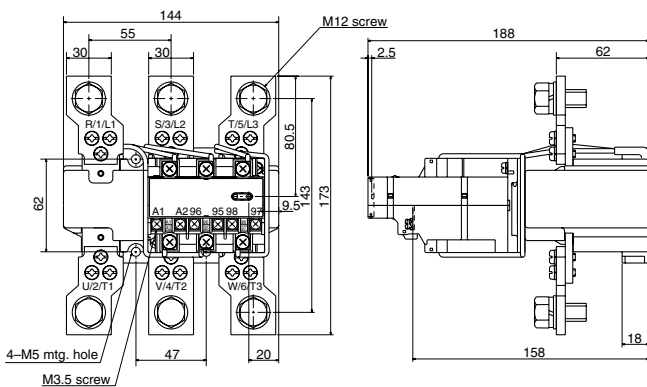

ET-N360 (Mass: 2.5kg)

3. DEFINITE PURPOSE CONTACTORS & STARTERS

3.1 DC Contactors

Series DU



DU-A60



DU-K180

The MITSUBISHI series DU contactors are designed for DC circuits, that is the variable-speed drive-control circuits (SCR switching circuit) and DC motor control circuits.

Features

- Compact design
- High break capacity
- CSA certified models are also available on AC operated type, add suffix "UR" immediately after the Frame size.
- Double break contacts
- UL recognized component (If  marking is required add suffix "UR" immediately after the Frame size).
- Long Life

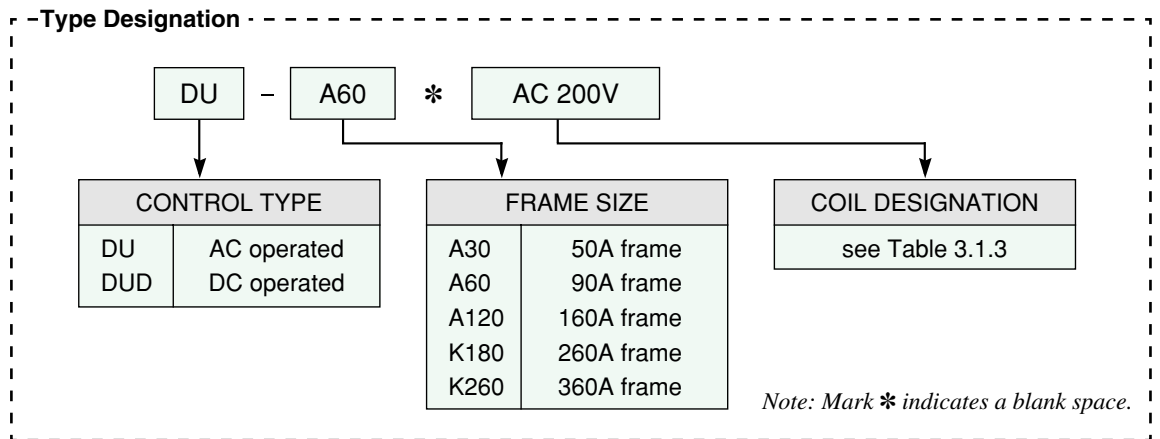

Specifications

- Number of main contacts type DU : 2NO1NC, type DUD : 2NO
Number of auxiliary contacts type DU & DUD : 2NO2NC

• Ratings

Table 3.1.1

Frame size				A30	A60	A120	K180	K260
Conventional free air thermal current			A	50	90	160	260	360
Rated operating current for SCR switching circuit*	NO contact	110VDC	A	40	80	160	260	360
		240VDC	A	40	80	160	260	360
		440VDC	A	15	30	60	90	130
		500VDC	A	15	30	60	90	130
1-pole	NC contact	110VDC	A	120	240	480	720	1.040
		240VDC	A	120	240	480	720	1.040
		440VDC	A	120	240	480	720	1.040
		500VDC	A	120	240	480	720	1.040
Rated operating current for SCR switching circuit	NO contact	110VDC	A	50	90	160	260	360
		240VDC	A	50	90	160	260	360
		440VDC	A	40	80	160	260	360
		500VDC	A	40	80	160	260	360
Rated operating current category DC 2 & 4	NO contact	110VDC	A	30	60	120	180	260
		240VDC	A	20	40	80	120	175
		440VDC	A	7.5	15	30	—	—
1-pole	NC contact	110VDC	A	20	40	80	100	150
		240VDC	A	15	30	60	75	100
		440VDC	A	7.5	15	25	—	—
Rated operating current category DC2 & 4	NO contact	110VDC	A	40	80	160	240	350
		240VDC	A	30	60	120	180	260
		440VDC	A	20	40	80	120	175
Rated operating current of aux. contacts	Category AC-15	110VAC	A	6				
	Category DC-13	240VAC	A	5				
	Category DC-13	110VDC	A	0.6				
		240VDC	A	0.2				

Note: For SCR switching, making current of NO contacts is 2 times the rated operating current and making current of NC contact is 1 times, the rated operating current which means the peak value at making. In this application NO and NC contacts do not break any current.

• Characteristics

Table 3.1.2

Frame size		A30	A60	A120	K180	K260	
Mechanical life	operations	2.5 million					
Electrical life	operations	0.5 million					
Permissible ambient temperature		°C					
		-10 to 55					
Coil voltage tolerance		times					
		0.85 to 1.1 (rated coil voltage)					
Coil consumption	Inrush	240	520	1260	480	480	
	Sealed	28	47	100	44	54	
	Watts	7 (26)	13 (35)	25 (50)	5(41)	7.3(55)	
	VA						
Operating time	Make	NO contacts ON	15 (60)	20 (100)	20 (140)	30(150)	40(180)
		NC contact OFF	12	13	13	26	37
	Break	NO contacts OFF	6(18)	11 (27)	11 (37)	110(25)	125(30)
		NC contact ON	12	18	18	112	135
Make and break capacity Category DC2 & DC4	Make	4 (at the rated operating current)					
	Break	4 (at the rated operating current)					
Permissible switching frequency		operations/hour					
		1,200					
Vibration resistance	10-55Hz	m/s ²					
Shock resistance	10 msec half sine wave	19.6					
		49					
Conductor size	Main terminals	2-25	2-35	6-70	10-150	16-185	
	Control terminals	1-4			1-2.5		

Note: Parenthesized data is for type DUD, DC operated contactors.

• Coil designation

Table 3.1.3

Coils for type DU-A			Coils for type DU-K		Coils for type DUD	
Coil designation	Applicable voltage		Coil designation	Applicable voltage	Coil designation	Applicable voltage
	50Hz	60Hz				
AC100V	100VAC	100-110VAC	AC100V	100-127VAC 50/60Hz	DC24V	24VDC
AC120V	110-120VAC	115-120VAC			DC48V	48VDC
AC200V	200VAC	200-220VAC	AC200V	200-240VAC 50/60Hz	DC100V	100VDC
AC230V	220-240VAC	230-240VAC			DC110V	110VDC
			AC300V	260-350VAC 50/60Hz	DC120V¹	120VDC
AC400V	380-415VAC	400-440VAC	AC400V	380-440VAC 50/60Hz	DC125V	120-125VDC ²
AC440V	415-440VAC	460-480VAC			DC200V	200VDC
AC500V	500VAC	500-550VAC	AC500V	460-550VAC 50/60Hz	DC220V	220VDC

Notes: 1. Only for type DUD-A60
2. 125V DC for type DUD-A60

■ Spare parts

Table 3.1.4

Spare parts	Ordering designation
Main contact kits for DU-□ ¹	MAIN KIT DU-□
Main contact kits for DUD-□ ²	MAIN KIT DUD-□
Auxiliary contact kits for DU(D)-A□ ³	Z926783G30
Auxiliary contact Units for DU(D)-K□ ⁴	UN-AX150
Coils for DU-□ ⁵	DU-□-COIL AC-V
Coils for DUD-□ ⁶	DUD-□-COIL DC-V

Notes: 1. Contact kit of type DU consists of three moving contacts and six stationary contacts.
2. Contact kit of type DUD consists of two moving contacts and four stationary contacts.
3. Aux. contact kits of type DU(D)-A□ are all the same.
4. Aux. contact units of type DU(D)-K□, UN-AX 150 are the same as those of the standard series S-N contactors.
5. Coils for DU-K 180/K 260 are the same as S-N220/N300 each.
6. Coil for DUD-A30 includes only one coil. Other DC operated coils of type DUD include two coils.

Contact Arrangements

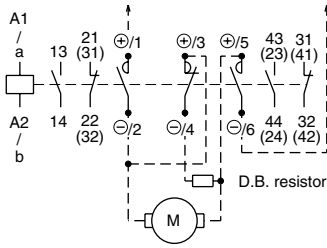

DU-A30, DU-A60, DU-A120
DU-K180, DU-K260

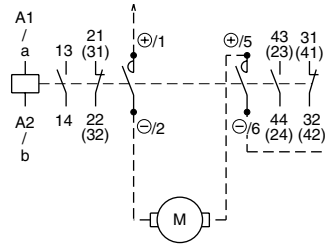

DUD-A30, DUD-A60
DUD-K180, DUD-K260

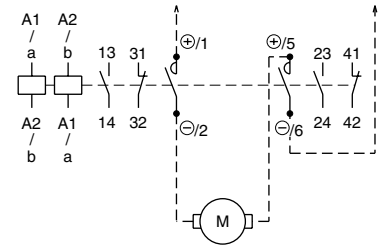

DUD-A120

Note: Values in parenthesis are shown on auxiliary terminals of DU-A or DUD-A .

Outline Dimensions

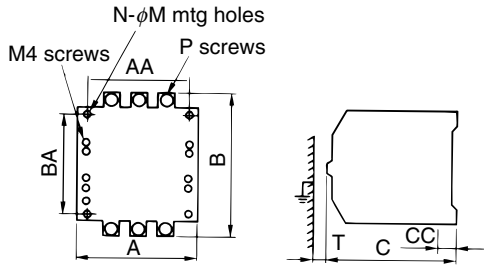

Type	A	AA	B	BA	C	CC	N	M	P	Mass(kg)	T
DU-A30	100	86	118	90	105.5	12.5	3	5	6	1.2	10
DU-A60	120	100	144	100	128.5	16	3	5	6	2.0	10
DU-A120	162	130	160	140	162	2.3	4	6	10	4.1	10
DU-K180	138	120	204	190	174	1.6	4	6	10	5.5	30
DU-K260	163	145	243	225	195	2.3	4	8	12	10	50
DUD-A30	101	86	108	90	135.5	3.2	3	5	6	2.1	10
DUD-A60	120	100	144	100	161.5	2	3	5	6	3.5	10
DUD-A120	162	130	160	140	187	2.3	4	6	10	7.1	10
DUD-K180	138	120	204	190	200	1.6	4	6	10	7.5	30
DUD-K260	163	145	243	225	220	2.3	4	8	12	13.5	50

3.2 Medium Voltage Vacuum Contactors

Series SH-V



SH-V160

The MITSUBISHI series SH-V contactors are specially designed for the areas of mining, pumping, sawing and other applications where voltage above 1500VAC are frequently used.

■ Features

- Compact design
- Lightweight
- Long service life
- Easy inspection & maintenance
- Applications over a wide range of voltage
- High insulation strength



Type Designation

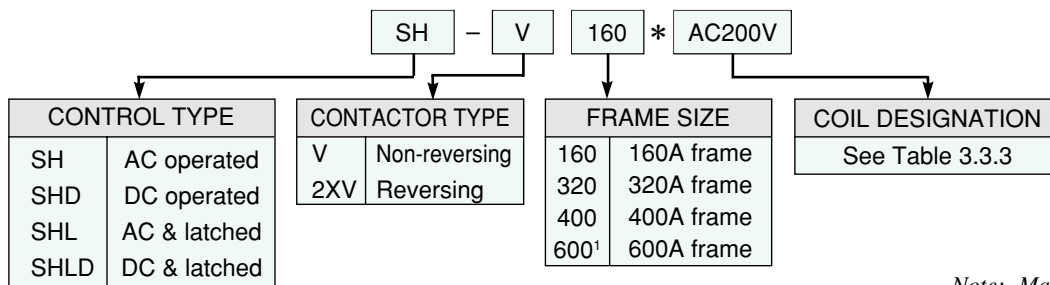

Note: Mark * indicates a blank space.

Note: 1. Only AC operated non-reversing type is available for Frame size 600.
SH-V600 is not presently certified by CSA.

■ Specifications

• Ratings

Table 3.2.1

Frame size			V160	V320	V400	V600
Rated insulation voltage		V	1,500	1,500	1,500	1,500
Rated operating capacity	Three phase motor category AC3	240V	55(180)	90(320)	115(400)	160(630)
		440V	110(180)	200(320)	250(400)	300(630)
		660V	160(180)	315(320)	400(400)	600(600)
		1,000V	225(160)	450(320)	550(400)	750(600)
	1,500V	315(160)	700(320)	800(400)	1,000(600)	
Rated operating capacity	Three phase capacitor	240V	50(150)	75(250)	100(300)	200(580)
		440V	100(150)	150(250)	200(300)	400(580)
		1,000V	250(150)	300(200)	300(200)	–
		1,500V	350(150)	500(200)	500(200)	–
Resistance load rating category AC-1		A	200	350	450	750
Conventional free air thermal current		Ith	200	350	450	750
Short circuit interrupting current		A	4,000			5,040
Withstand current for short time	for 2 seconds	kA	4			6
	for 10 milliseconds	kA	33			
Rated operating current of aux. contacts	Category AC-15	240VAC	5			
		480VAC	3			
		660VAC	3			
Rated operating current of aux. contacts	Category DC-13	110VAC	1.2			
		220VAC	0.2			

Note: A surge absorber is required for motors less than 5.5kW only.

● Characteristics

Table 3.2.2

Frame size			V160	V320	V400	V600
Mechanical life ^{1,2}		operations	2.5 million			
Electrical life ^{3,4} .(category AC3)		operations	0.5 million			
Permissible ambient temperature		°C	-10 to +55			
Coil voltage tolerance		times	0.85 to 1.1(rated coil voltage)			
Coil consumption	AC operated	Inrush VA	550			1150
		Sealed VA	45			55
		Watts W	5.2			7.3
	DC operated	Inrush VA	500			—
		Sealed VA	40			—
	Mechanically latched	Inrush VA	550			—
Operating time(approx.)	Make Break	msec	40			65
		msec	130			80
Make and break current capacity	Make Break	times	10(at AC3 rated operating current)			
		times	8(at AC3 rated operating current)			
Permissible switching frequency		operations/hour	1,200			
Vibration resistance	10-55Hz	m/s ²	19.6			
Shock resistance	Sine wave pulse	m/s ²	49			
Conductor size	Main terminals	mm ²	5.5-100	14-200		70-325
	Control terminals	mm ²	1-2.5			

- Notes: 1. Mechanical life of the latched type is 0.25 million operations.
 2. Mechanical life of vacuum tube is 1 million.
 3. When the load is three phase capacitors, electrical life is 0.1 million operations.
 4. Electrical life of the latched type is 0.25 million operations.

● Coil Designation

Table 3.2.3

Coil designation	Rated voltage
AC100V	100~127V 50/60Hz
AC200V	200~240V 50/60Hz
AC300V	260~350V 50/60Hz
AC400V	380~440V 50/60Hz
AC500V	460~550V 50/60Hz
DC100V	100-110 VDC
DC200V	200-220 VDC

Note: When ordering the latched type contactor, specify the coil designation of the closing coil and the tripping coil.
 Place "MC" before the closing coil designation and place "MT" before the tripping coil designation.

■ Spare Parts & Accessories

Table 3.2.4

Contactor Catalog Number	Coil Part Number ¹	Main Contact Part Number	Auxiliary Contacts Number		Vacuum Tube Gauge Part Number
			Replacement(1NO 1NC)	Add-on(2NO 2NC)	
SH-V160	SH-V160COIL AC V	SH-V160TUBES ²	UA-AXVV1	UA-AXVV2 ³	SH-V160 GAUGE
SH-V320		SH-V320TUBES ²			
SH-V400		SH-V400TUBES ²			
SH-V600	SH-V600COIL AC V	SH-V600TUBES ²		UA-AXVV4	SH-V600 GAUGE

- Notes: 1. See Table 3.3.3 for Coil Designation.
 2. Set of three vacuum bottles supplied.
 3. Consists of two UA-AXVV1 contact blocks on the mounting plate. Mounts on left side of contactor.

● Surge absorber

As the vacuum tubes of SH-V use a special contact material, the surge voltage by current chopping is very small. Surge absorbers are required only for motors smaller than 5.5kW.

Table 3.2.5

Applicable voltage	Ordering designation
up to 440VAC	UA-SU4
up to 550VAC	UA-SU5
up to 660VAC	UA-SU6
up to 1,000VAC	UA-SU10
up to 1,500VAC	UA-SU15

Contact Arrangement

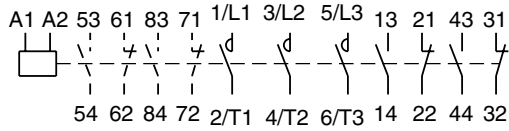

SH-V□

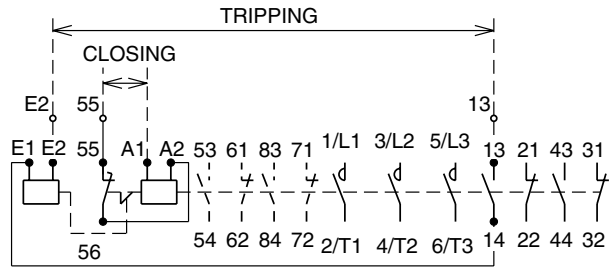

SHL-V□
SHLD-V□

Outline Dimensions

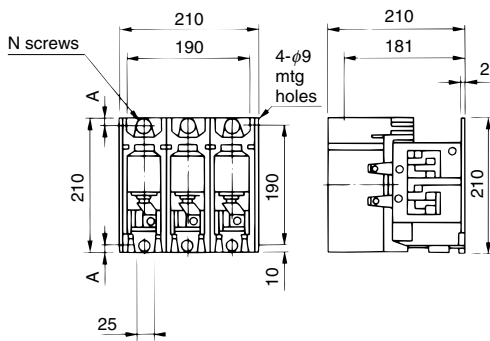

SH-V160, V320, V400 (Mass:12.5kg)

KEYS	N	A
SH-V160	M8	10
SH-V320	M10	12.5
SH-V400	M10	12.5
SHL(D)-V160	M8	10
SHL(D)-V320	M10	12.5
SHL(D)-V400	M10	12.5

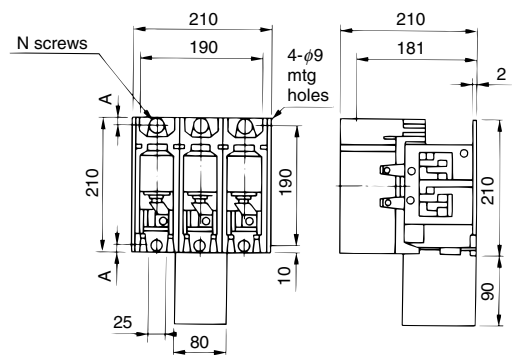

SHL-V160, V320, V400 (Mass:14kg)
SHLD-V160, V320, V400

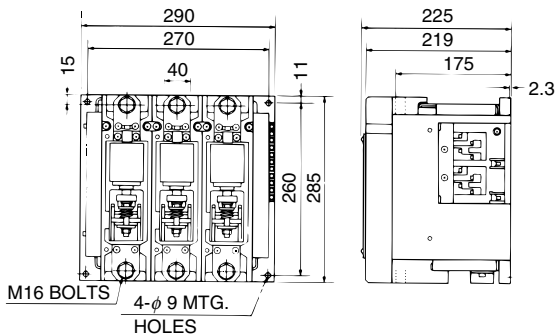

SH-V600(Mass:22kg)

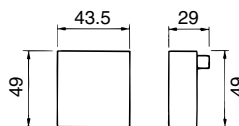

UA-AXVV1(Mass:0.2kg)

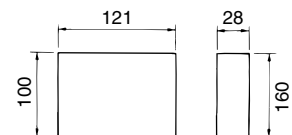

UA-AXVV2 (Mass:0.5kg)

3.3 Compact 3-Pole Contactors

The MITSUBISHI series S-N \square 8 compact 3-pole contactors are designed for limited panel space applications such as machine control panels.



S-N48

Features

- Compact design—Very limited required mounting space.
- Front clip-on type auxiliary contact block can be added.
- Coil surge absorbers are available.
- Can be mounted on 35mm rail.

Type Designation

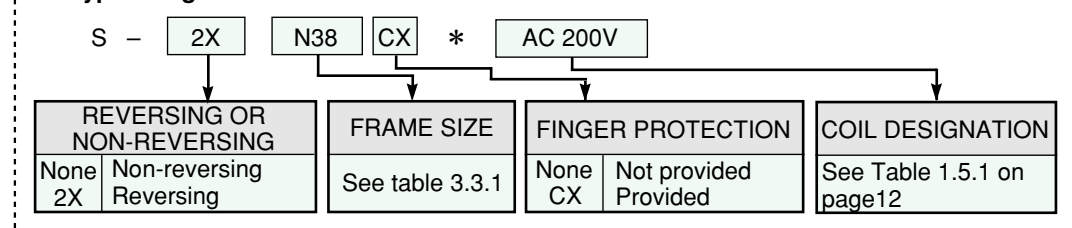

Note: Mark* indicates a blank space

Specifications

Rating and characteristics

Table 3.3.1

Type			S-N18 (CX)	S-N28 (CX)	S-N38 (CX)	S-N48 (CX)
Rated insulation voltage	V		AC690			
Rated operational current	220-240V	A(kW)	18(4.5)	26(7.5)	39(11)	50(15)
	380-440V	A(kW)	16(7.5)	17(7.5)	32(15)	40(18.5)
3-ph, category AC-3	500V	A(kW)	13(7.5)	13(7.5)	24(15)	32(18.5)
	690V	A(kW)	9(7.5)	9(7.5)	12(11)	17(15)
Conventional free air thermal current	A		25	30	60	80
Electrical life	operations (million)		1			
Mechanical life			10	5		
Rated making current for 100,000 cycle operations Peak let through time 0.5ms	A		200	300	500	670
Switching frequency(AC3)	operations/hour		1800	1800	1800	1200
Coil consumption (at rated coil voltage)	Inrush	VA	60		110	
	Sealed	VA	10		13	
	Watts	W	3		4 · 5	
Terminal screw size	Main terminal		M4	M4	M5	M5
	Control terminal		M3.5	M3.5	M3.5	M3.5
Conductor size (Compression terminal size)	Main terminal		1~6		2~16	
	Control terminal		1~2.5		1~2.5	
Additional auxiliary contact block			UN-AX2 or UN-AX4			

Note: 1. For finger protection type, order model name followed by suffix "CX".

Contact Arrangement

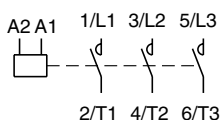

S-N \square 8 (CX)

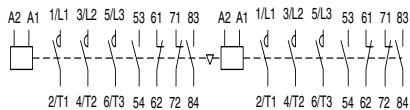

S-2xN \square 8 (CX)

Outline Dimensions

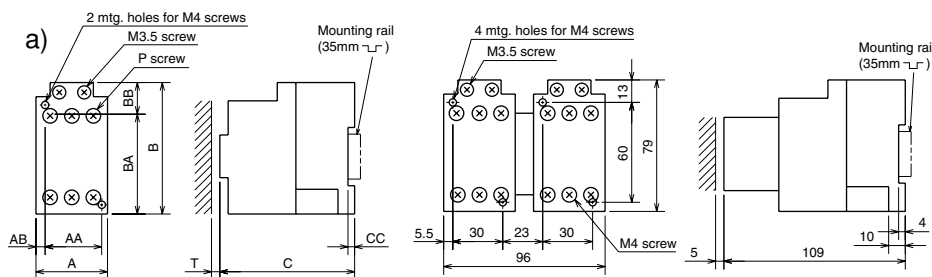

S-2xN18 (CX), N28 (CX)

S-2xN38 (CX), N48 (CX)

	Fig.	A	B	C	AA	AB	BB	BA	CC	CA	D	P	Q	Mass(kg)	T
S-N18 (CX), N28 (CX)	a	43	79	81	30	7	60	6	10	109	4	M4	M3.5	0.33	5
S-N38 (CX), N48 (CX)	a	54	90	93	40	7	80	6	7	121	4	M5	M3.5	0.4	5

3.4 NC Main Contact Contactors



B-N20



B-N65

The MITSUBISHI series B-N contactors are specially designed for the dynamic braking circuit of motors, switching motor-starting resistors and switching of emergency lighting.

Features

- 2 or 3 NC main contacts.
- Suitable for a variety of loads.
- Compact design
- Both AC operated models & DC operated models

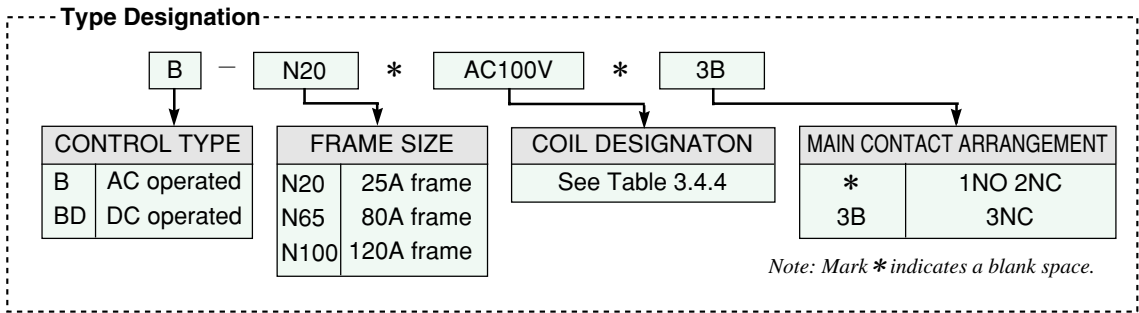

Specifications

- Number of main contacts: Special arrangement 3 NC can be supplied only with type B-N20/N65.

Ratings

Table 3.4.1

FRAME SIZE			N20	N65	N100	
Conventional free air thermal current	lth	A	25	80	120	
DC Rated operating current category DC-2 & DC-4	2NC ¹	110VDC	A	8	20	30
		220VDC	A	1	3	3
	3NC ²	110VDC	A	15	50	—
		220VDC	A	5	20	—
Electrical life	Operations	0.5 million				
DC Rated operating current category DC-1	2NC ¹	110VDC	A	15	30	40
		220VDC	A	5	10	20
	3NC ²	110VDC	A	20	65	—
		220VDC	A	10	30	—
Electrical life	Operations	0.5 million				
AC 3-ph Rated operating current	1NC	200-220VAC	A	18	50	80
		380-440VAC	A	13	35	55
	Electrical life (Making/Breaking)	Operations	0.5 million (6 (rated operating current)/no breaking)			
AC 1-ph Rated operating current	2NC ¹	200-220VAC	A	18	50	80
		Electrical life (Making/Breaking)	Operations	0.5 million (6 (rated operating current)/rated operating current)		

Notes: 1. At 2NC series connection
2. At 3NC series connection

Rated operating current of aux. contacts.

Table 3.4.2

Category	Rated voltage	A
AC-15	120VAC	6
	240VAC	5
	440VAC	3
	500VAC	3
DC-13	48VDC	3
	110VDC	0.6
	220VDC	0.2

Notes: 1. At 2NC series connection

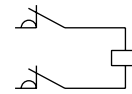

2. At 3NC series connection

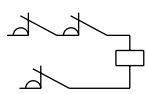

Characteristics

Table 3.4.3

FRAME SIZE			N20	N65	N100
Mechanical life	Operations	5 million			
Coil consumption	Inrush	VA	90 (—)	210 (—)	270 (—)
	Sealed	VA	15 (—)	23 (—)	24 (—)
	Watts	W	4 (9)	2.8 (24)	2.9 (24)
Coil voltage tolerance	times	0.85 to 1.1 (at rated coil voltage)			
Operating time	Coil off → NC on	msec	19 (16)	75 (21)	120 (50)
	Coil on → NC off	msec	11 (35)	20 (80)	22 (130)
Make and break current capacity	DC-2 & DC-4	times	4 (rated operating current L/R ≤ 15 msec)		
Conductor size	Main terminals	mm ²	1-6	2-25	(6-70) ²
	Control terminals	mm ²	1-2.5		

Notes: 1. Parenthesized data if for type BD-□ DC operated contactors.
2. Conductor size in parentheses indicate compression terminal style not for bare clamping.

Coil Designation

Table 3.4.4

Type	Coil designation	Applicable voltage
B-N20	AC100V	100V/50Hz, 100-110V/60Hz
	AC200V	200V/50Hz, 200-220V/60Hz
	AC400V	380-415V/50Hz, 400-440V/60Hz
B-N65 B-N100	AC100V	100-127V/50Hz, 100-127V/60Hz
	AC200V	200-240V/50Hz, 200-240V/60Hz
	AC400V	380-440V/50Hz, 380-440V/60Hz
BD-N20 BD-N65 BD-N100	DC100V	DC100V
	DC110V	DC110V
	DC200V	DC200V
	DC220V	DC220V

Spare Parts

Table 3.4.5

Spare parts	Ordering designation
Main contact kits for B(D)-N20 1NO2NC for B-N20 3NC for B(D)-N65 1NO2NC for B-N65 3NC for B(D)-N100 Auxiliary contact kits for B(D)-N20 for B(D)-N65 for B(D)-N100 Coils for B-N <input type="checkbox"/> AC operation for BD-N <input type="checkbox"/> DC operation	PARTS MAIN KIT B(D)-N20 1A2B BH739N304 B-N20 3B BH739N302 B(D)-N65 1A2B BH769N305 B-N65 3B BH769N306 B(D)-N100 BH779N303 PARTS AUX KIT B(D)-N20 BH739N312 B(D)-N65 BH539N315 B(D)-N100 BH579N312 B-N <input type="checkbox"/>-COIL AC...V BD-N <input type="checkbox"/>-COIL DC...V

Contact Arrangements

main contacts: 1NO2NC
aux. contacts: 2NO

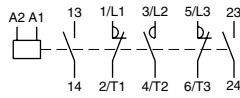

B-N20, BD-N20

main contacts: 3NC
aux. contacts: 2NO

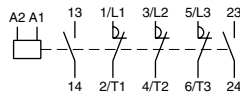

B-N20

main contacts: 1NO2NC
aux. contacts: 2NO2NC

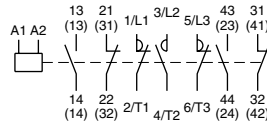

B-N65, B-N100
BD-N65, BD-N100

main contacts: 3NC
aux. contacts: 2NO2NC

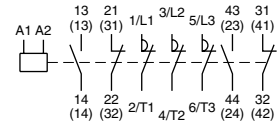

B-N65

Outline Dimensions

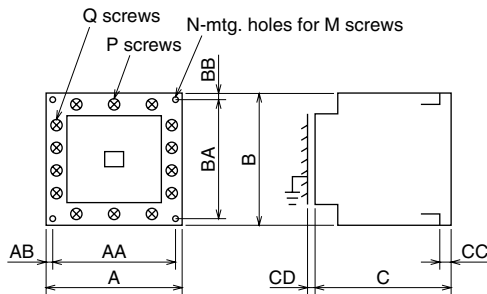

Type	A	B	C	AA	AB	BA	BB	CC	CD	N	M	P	Q	Mass(kg)
B-N20	63	81	81	54	4.5	60	14	6.5	5	2	M4	M4	M3.5	0.4
B-N65	100	124	127	80	10	110	7	12	10	2	M5	M6	M4	1.7
B-N100	100	150	137	90	5	125	12.5	2	10	4	M4	M8	M4	2.7
BD-N20	63	81	113	54	4.5	60	14	6.5	5	2	M4	M4	M3.5	0.7
BD-N65	100	134	158	80	10	110	17	12	10	2	M5	M6	M4	3.0
BD-N100	102	150	162	90	6	125	12.5	1.6	10	4	M4	M8	M4	4.3

3.5 Delay Open Type Magnetic Starters & Contactors

Series S/MSO-N□DL



MSO-N□DL

The MITSUBISHI series MSO-N□DL starters and S-N□DL contactors are specially designed to prevent instantaneous “drop-out” when connected to motors, resulting from momentary voltage drop or power interruption caused by lightning or similar. A capacitor connected in parallel with the operating coil of the contactor discharges so that the starter or contactor will remain closed for 1 to 4 seconds.

Type Designation

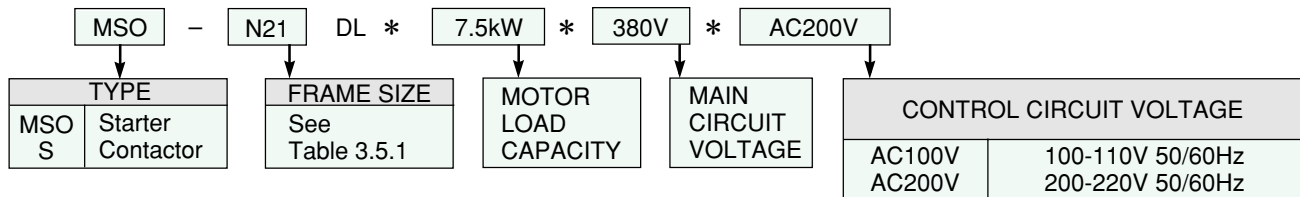

Note: Mark * indicates a blank space.

Specifications

Ratings and Characteristics

Table 3.5.1

Frame size			N12	N21	N35	N50	N65	N80	N95	N150	N220	N300	N400
Three phase motor	220-240VAC	kW	3.5	5.5	11	15	18.5	22	30	45	75	90	125
	380-440VAC	kW	5.5	11	18.5	22	30	45	55	75	132	160	220
	500-550VAC	kW	5.5	11	18.5	22	30	45	55	90	132	160	225
Category AC-3	220-240VAC	A	13	22	40	55	65	85	105	150	250	300	400
	380-440VAC	A	12	22	40	50	65	85	105	150	250	300	400
	500-550VAC	A	9	17	32	38	60	75	85	140	200	250	350
Conventional free air thermal current	I _{th}	A	20	32	60	80	100	135	150	200	260	350	450
Available aux. contacts			1NO1NC										
Holding time	sec.		2 ⁺² ₋₁										
Control circuit power consumption	Inrush	VA	21	40	44	55	55	66	66	76	100	140	140
	Sealed	VA	13	18	19	26	26	27	27	55	66	85	85

Diagrams Circuit

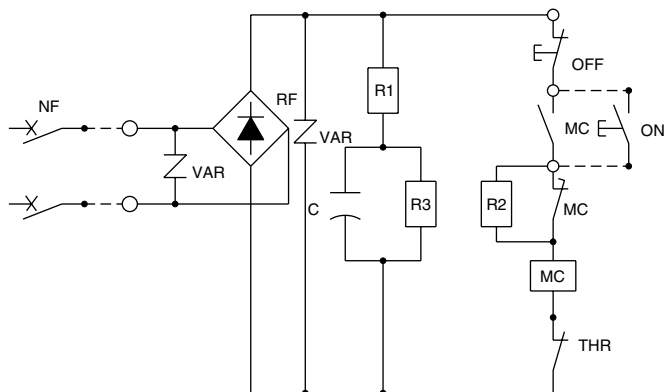

Typical Wiring Diagram

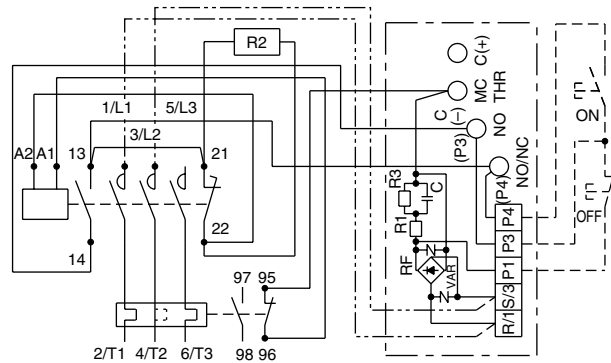

Note: R1-R1 & S3-S3 (---) wiring is omitted if the control circuit voltage is 100VAC or the main circuit voltage differs from the control circuit voltage.

● **Caution**

1. When the circuit breaker (NF) is made (ON) and disconnected (OFF) repeatedly within a short time interval [eg: when the instantaneous power failure occurs within a short time interval], electrical parts might be damaged or specified holding time might not be assured.
Causes; 1) Overload occurs by frequent inrush current to RF and R1.
2) Enough electricity is not charged into the capacitor (C).
2. Even after the power is turned off (after the NF is disconnected), current might remain in the capacitor (C). So please take care to avoid the electrical shock, when you check or repair the system.

■ **Outline Dimensions**

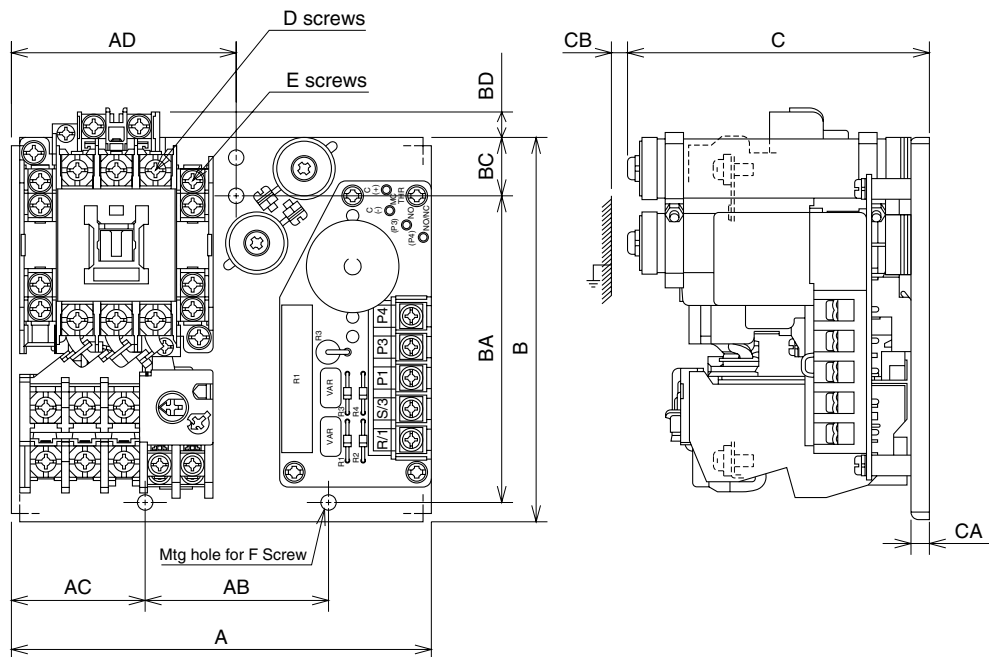

■ **Dimensions**

Table 3.5.2

Dimension / Model	A	AB	AC	AD	B	BA	BC	BD	C	CA	CB	D	E	F
MSO-N12DL	132	40	49	69	110	100	5	12.5	98	6	5	M3.5	M3.5	3-M4
MSO-N21DL	137	60	43	73	125	100	19	11	98	6	5	M4	M3.5	3-M4
MSO-N35DL	134	50	42	67	162	150	6	23	114	8	5	M5	M3.5	3-M4
MSO-N50/65DL	150	50	56	81	168	150	9	26.5	141	8	10	M6	M4	3-M5
MSO-N80/95DL	170	100	35	85	220	200	10	39.5	165	8	10	M6	M4	3-M6
MSO-N150DL	210	140	26	105	270	250	10	33	177.5	8	30	M8	M4	3-M8
MSO-N220DL	230	140	20	90	290	250	12	21	208.5	8	30	M10	M4	3-M8
MSO-N300/400DL	300	200	10	-	361.5	200	25	30	229	8	50	M12	M4	4-M8

Notes: 1. Dimensions CB is the arc clearance.

2. Outline dimensions of S-N□DL are the same as those of MSO-N□DL, except for S-N300/N400DL. Dimension B of S-N300/N400DL is 250mm.

3.6 DC Interface Contactors

Series SD-Q



SD-Q DC interface contactors designed to be directly driven by the transistor output DC24V are DC operated contactors of compact size and high ability.



- By combining the efficient electromagnet with permanent magnet, SD-Q contactors are able to be directly driven by the transistor output DC24V 0.1A of a programmable logic controller, etc. SD-Q series is lineup contained reversing contactors applied to motors of 3φ 440V5.5kW starters with the thermal overload relay, and additional auxiliary contact block, etc.



Features

- Special design to be directly driven by the transistor output DC24V
 - By combining an electromagnet with permanent magnet, coil operating current is reduced to DC24V55mA(1.3W) for SD-Q11 and DC24V75mA(1.8W) for SD-Q19
 - Compliance with many international standards
Applicable standards: IEC, DIN, VDE, BS, JIS, JEM
Approved standards: UL, CSA, TÜV
 - Built-in surge absorber
 - Provision of terminal covers
 - Mountable on a IEC 35mm width rail
 - Compact size and high performance
- SD-Q11, SD-Q12 : 3φ240V3kW SD-Q19 : 3φ240V4.5kW
 3φ440V4kW 3φ440V5.5kW
- Mirror contact: Normally closed auxiliary contact cannot be closed when power contact is welded. The function conform to requirements of IEC60947-4-1.
 - Variable combination: Auxiliary contact block (UQ-AX2(KR)) can be added onto a contactor (SD-Q11 (SD-QR11))

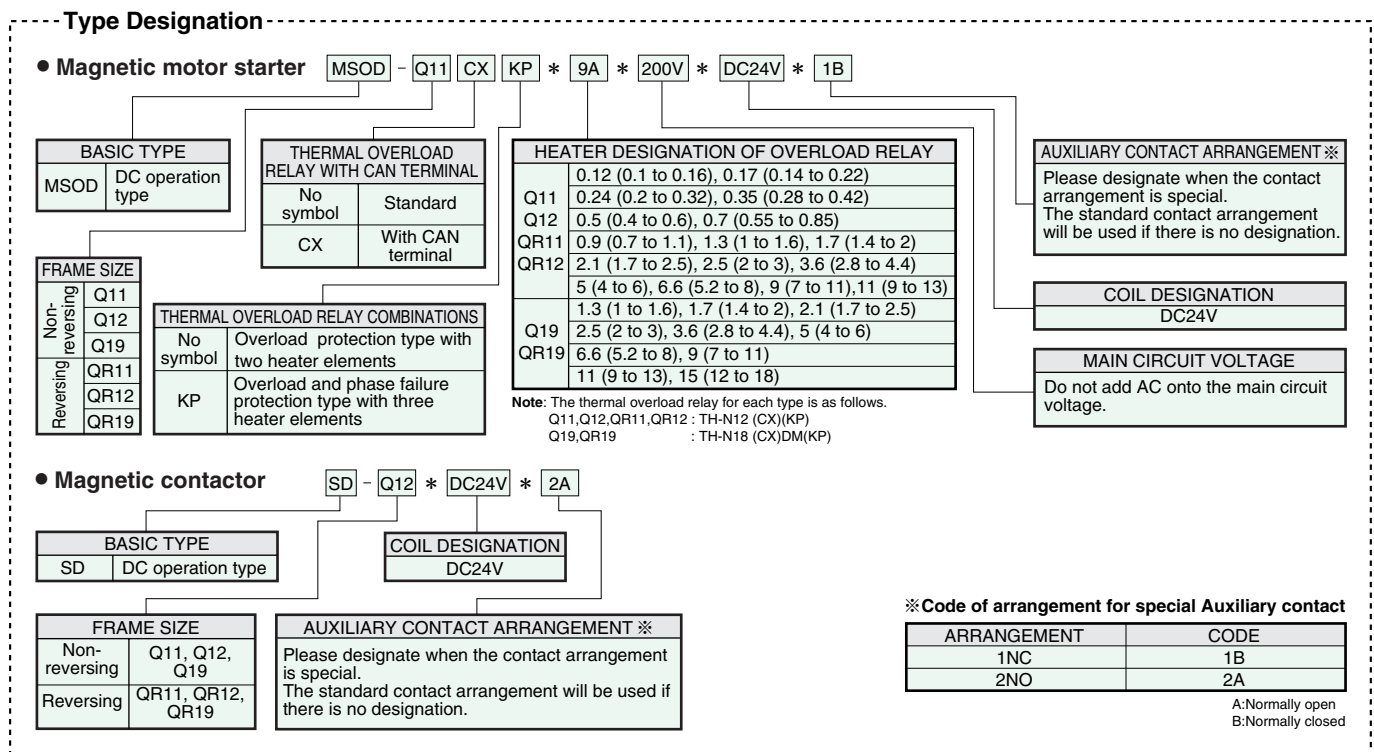

Note: Mark * indicates a blank space.

■ Specifications

● Ratings & characteristics

Table 3.6.1

Type		Non-reversing	SD-Q11 SD-Q12	SD-Q19	
		Reversing	SD-QR11 SD-QR12	SD-QR19	
Rated insulation voltage		V	690		
Conventional free air thermal current		A	20	30	
Rated operational current	Category	220 to 240V AC	A	12	18
	AC-3	380 to 440V AC	A	9	13
		500V AC	A	7	13
		690V AC	A	5	7
Category	AC-1	220 to 240V AC	A	**1) 10 (15)	30
		380 to 440V AC	A	10	20
Rated 3ph motor capacity	Category	220 to 240V AC	kW	3	4.5
	(IEC)	380 to 440V AC	kW	4	5.5
	AC-3	500V AC	kW	4	7.5
		690V AC	kW	4	5.5
Pick-up voltage(to rated coil voltage)		%	85	85	
Coil consumption(at rated coil voltage)(at 20°C)		W	1.3	1.8	
Coil current(at 20°C)		mA	55	75	
Operating times (at rated coil voltage)	Closing	mS	<50	<60	
	Opening	mS	<20	<35	
Mechanical endurance		operations	10 million	10 million	
Electrical endurance	category AC-3	operations	1 million	2 million	
	category AC-1	operations	0.5 million	0.5 million	
Permissible ambient temperature		°C	-10 to 55	-10 to 55	
Switching frequency		operations/hour	1800	1800	
Conductor size		mm ²	1 to 2.5	main; 1 to 6 control; 1 to 2.5	
Terminal screw tightening torque range (standard value)		N·m	0.94 to 1.17 (1.0)	main; 1.18 to 1.86 (1.47) control; 0.94 to 1.51 (1.17)	

Note:*1. The electrical endurance at the rating given in parentheses is 0.25 million.

● Ratings of auxiliary contacts

Table 3.6.2

Rated insulation voltage		V	690	
Conventional free air thermal current		A	10	
Rated operational current	Category	240V AC	A	3
	AC-15	440V AC	A	1
	Category	24V DC	A	10
DC-12				
Mechanical endurance		operations	10 million	
Electrical endurance		operations	**2) 0.5million	

Note:*2. The electrical endurance for the UQ-AX2 (KR) type auxiliary contact block is 0.25 million.

● Auxiliary contact block

Table 3.6.4

Use	For non-reversing type and for reversing type left side	For reversing type right side
Model name	UQ-AX2	UQ-AX2KR
Applicable contactor /starter	SD-Q11.SD-QR11 MSOD-Q11 MSOD-QR11	SD-QR11 MSOD-QR11

● Coil rating and Ordering designation

Table 3.6.3

Rated voltage (V DC)	Ordering designation
24VDC	24VDC

Note: The operation coil terminal has a polarity. A1(+), A2(-)

Contact Arrangement & Wiring Diagram

Table 3.6.5

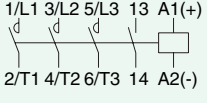
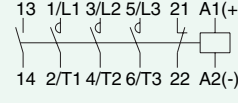
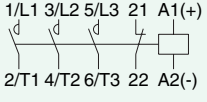
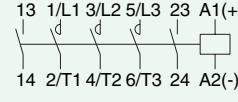
		Non-reversing	
Type	SD-Q11	SD-Q12.Q19	
Standard	Aux. 1 NO 	Aux. 1 NO 1 NC 	
	Special	Aux. 1 NC 	Aux. 2 NO 

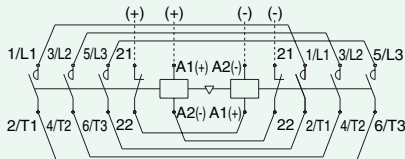
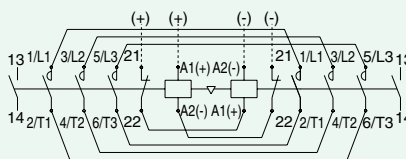
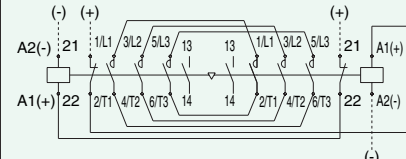
		Reversing		
Type	SD-QR11	SD-QR12	SD-QR19	
Standard				

Outline Dimensions

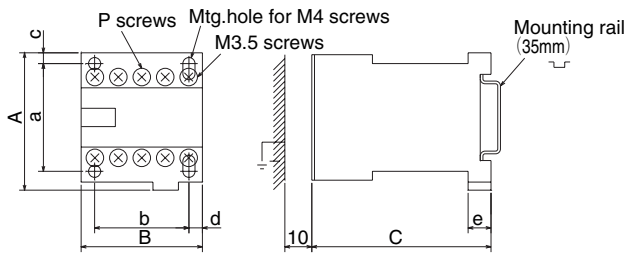

Fig.1 SD-Q type

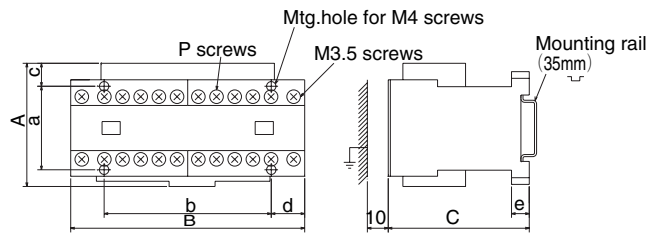

Fig.2 SD-QR type

• Magnetic contactors and magnetic motor starters (mm)

Type	Dimensions									Mass [kg]	Reference drawing	
	A	B	C	a	b	c	d	e	P			
Non-reversing	SD-Q11	51	45	66.5	40	35	4	5	8.5	M3.5	0.19	Fig.1
	SD-Q12	52	56	67.5	40	35	5	5	8.5	M3.5	0.21	Fig.1
	SD-Q19	58	66	78	50	55	4	5.5	9	M4	0.34	Fig.1
Reversing	SD-QR11	59	90	66.5	40	80	11	5	8.5	M3.5	0.42	Fig.2
	SD-QR12	59	112	67.5	40	80	11	16	8.5	M3.5	0.46	Fig.2
	SD-QR19	79.5	133	77.5	50	110	22	11.5	9	M4	0.72	Fig.2

3.7 DC Interface Modules



The MITSUBISHI type UN-SY interface module is an optional unit for S-N series contactors or SR-N series relays, controlled by the transistor output of a programmable controller.

■ Features

- Easy mounting on the Type S-N10 to S-N65 contactors and SR-N series relays.
- Separate mounting type for the Type S-N80 to S-N400 contactors.
- Relay or solid state output versions are available.

Type Designation

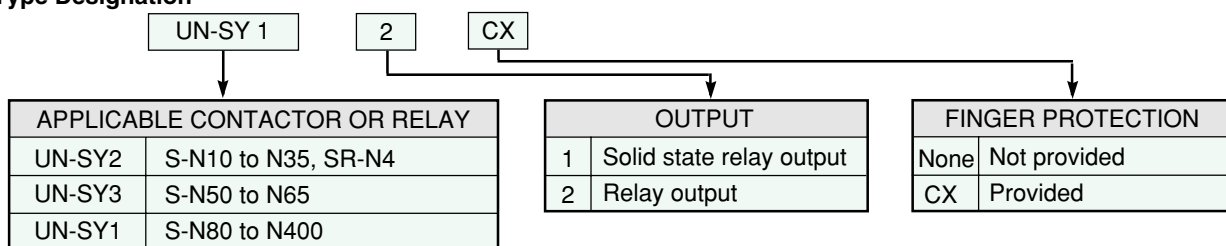

Note: Suffix "CX" is available only for UN-SY21 or SY22.

■ Specifications

Table 3.7.1

Type		UN-SY21(CX)	UN-SY31	UN-SY11	UN-SY22(CX)	UN-SY32	UN-SY12
Output		Solid state relay			Relay		
Applicable Type of contactor or relay	Direct mounting to contactor or relay	S-N10 to N35 S-N18, N28, N38, N48	S-N50, N65	–	S-N10 to N35 S-N18, N28, N38, N48	S-N50, N65	–
	Separate mounting	–	–	S-N80 to N400	–	–	S-N80 to N400
Input	Rated control voltage	24Vdc			24Vdc		
	Permissible voltage tolerance	80% to 110% of rated control voltage					
	Min. working voltage	18Vdc			18Vdc		
	Max. breaking voltage	4Vdc			1Vdc		
	Power consumption	0.4W			0.24W		
Output	Rated voltage	100Vac to 240Vac 50/60Hz					
	Rated operating current	0.5A (category AC11)					
	Response time	11ms or less			10ms or less		
	OFF-state leakage current	3mA/240Vac			–		
	Mechanical life	–			5 million operations		
	Electrical life	–			1 million operations		
Ambient temperature		–10 to 55°C					

■ Connection

(1) Solid State Output

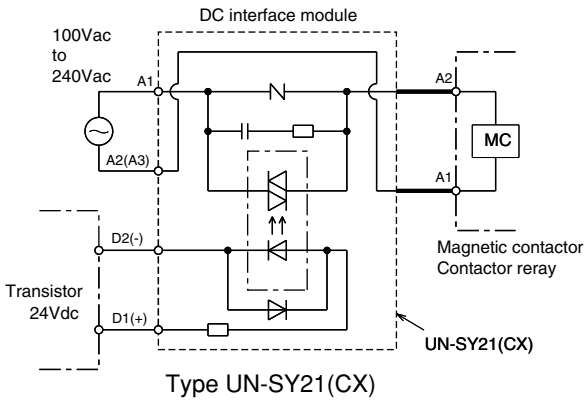

(2) Relay Output

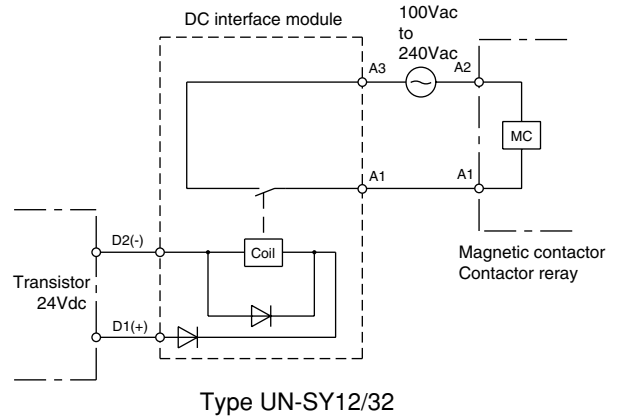
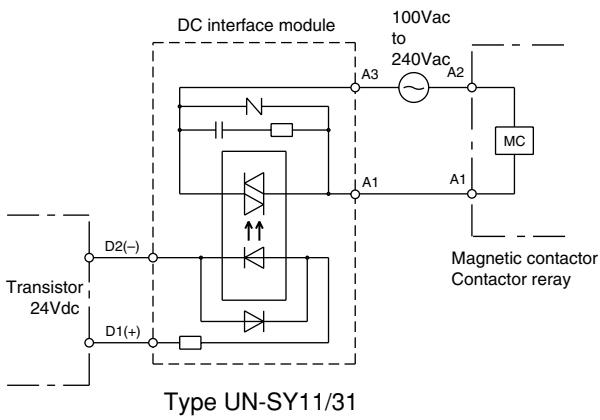
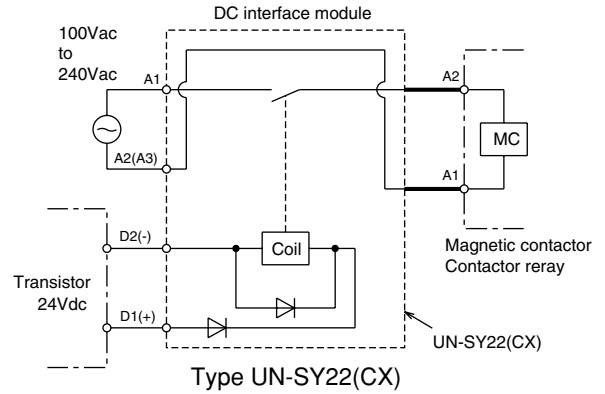

■ Mounting

- Direct mounting – Type S-N10 to S-N65 and SR-N4
Remove the coil terminal screw from the contactor or relay, then slide the tab on the interface module to the groove on the contactor or relay. Fasten the connecting conductor with the coil terminal screw.
- Separate mounting – Type S-N80 to S-N400
Mount the interface module (UN-SY11/12) with screw on a panel as follows.

■ Outline Dimensions

Type Number	UN-SY21/22(CX)	UN-SY-31/32	UN-SY11/12	
Module Outline dimensions			<p>M3.5 screw φ4.5 mtg. hole</p>	
Overall Mounting dimensions	Coupling outline			Mtg. hole layout for separate mounting
	<p>(A2) (A1)</p> <p>S-N10 S-N11 SR-N4 SR-N8 (S-N18) (S-N28)</p>	<p>(A2) (A1)</p> <p>S-N20 S-N21 (S-N25) (S-N35) (S-N38) (S-N48)</p>	<p>(A2) (A1)</p> <p>S-N12 SR-N5</p>	<p>M4 screw 3.2 hole</p>

4. RELAYS

4.1 Contactor Relays



SR-N4

The MITSUBISHI series SR-N contactor relays are specially designed for use in low voltage control applications. Series SR-N have many superior features.

■ Features

- High reliability: By adopting bifurcated moving contacts and by improving the shape of the contacts, contact performance has been made more reliable than ever.
- Long life
- Easily visible coil ratings
- Various accessories common with the series S-N contactors (Head-and side clip-on type additional aux. contact blocks, surge absorbers, safety covers)
- Finger protected types are available (DIN 57106/VDE 0106 Part 100)
- Can be mounted on 35mm rail
- Dust-proof construction
- Easy wiring (self-rising terminal screws)

Type Designation

● Standard types

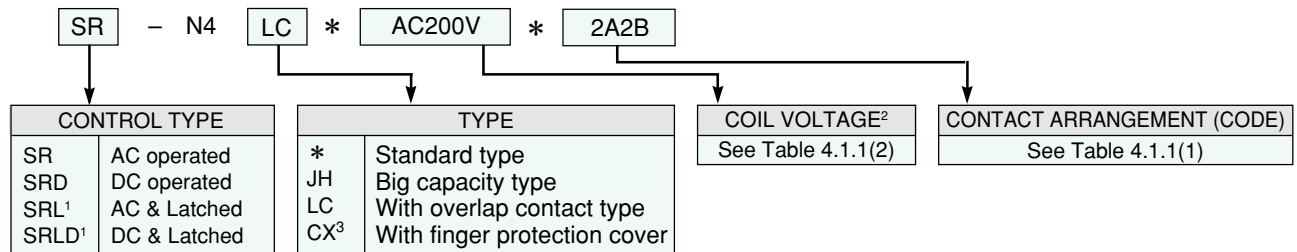

Notes: 1. For latched type relays, JH and LC types cannot be available.

2. When ordering the latched type relays, please specify the closing coil and tripping coil voltage.

ex: SRL-N4 * MC-AC200V * MT-AC100V * 4A
 closing coil tripping coil

3. Only suffix "CX" is admitted to make any combination with other tabulated suffixes.

Note: Mark * indicates a blank space.

4.1.1 Specifications

Rating and characteristics

Table 4.1.1 (1)

Type	SR-SRD-	N4 (CX)	N4JH (CX)	N4LC (CX)		
Available contact arrangements (code)		4NO (4A) 3NO+1NC (3A1B) 2NO+2NC (2A2B)	4NO (4A) 2NO+2NC (2A2B)	4NO (4A) 2NO+2NC (2A2B)		
Rated insulation voltage	V	660				
Conventional free air thermal current	lth	16	20	16		
Rated operating current	Category AC-15 (coil load)	110VAC	A	6	10	6 (3) ²
		230VAC	A	5	10	5 (3) ²
		440VAC	A	3	5	3 (3) ²
		550VAC	A	3	4	3 (3) ²
	Category AC-12 (resistive load)	110VAC	A	16	20	16
		230VAC	A	12	16	12
		440VAC	A	5	10	5
		550VAC	A	5	10	5
	Category DC-13 (large coil load)	24VDC	A	5		3
		48VDC	A	3		2
		110VDC	A	0.8(2) ¹		0.5
		220VDC	A	0.2(0.8) ¹		0.1
	Category DC-14	24VDC	A	8		5
		48VDC	A	3		2
		110VDC	A	2(4) ¹		1
		220VDC	A	0.4(1) ¹		0.2
	Category DC-12 (resistive load)	24VDC	A	10		8
		48VDC	A	8		5
110VDC		A	5(8) ¹		3	
220VDC		A	1(3) ¹		0.5	
Mechanical life	Operations	10 million (latched type 1 million)				
Electrical life	Operations	0.5 million				
Permissible ambient temperature/humidity	°C/%RH	-25 to +55/45 to 85				
Coil consumption	Ac-operated	Inrush	VA	60		
		Sealed	VA	10		
	DC-operated	Watts	W	3		
	DC-operated	Watts	W	7		
Coil voltage tolerance	times	0.85 to 1.1 (rated coil voltage)				
Operating time (average)	Make	ms	15 (AC)	50 (DC)		
	Break	ms	10 (operated)	10 (operated)		
Switching frequency	operations /hour	1,800				
Vibration resistance	10-55Hz	m/s ²	19.6			
Shock resistance	10 msec. half sine wave	m/s ²	49			
Conductor size		mm ²	1.0 to 2.5			

Notes: 1. Parenthesized rated operating current is for switching the load in 2-pole series connection.

2. Parenthesized rated operating current is for switching of NC contact.

Coil voltage

Table 4.1.1 (2)

Coil designation	Rated voltage (AC)		Coil designation	Rated voltage (AC)		Coil designation	Rated voltage (DC)
	50Hz	60Hz		50Hz	60Hz		
AC12V	12V	12V	AC220V	208-220V	220V	DC24V	24VDC
AC24V	24V	24V	AC230V	220-240V	230-240V	DC48V	48VDC
AC48V	48-50V	48-50V	AC260V	240-260V	260-280V	DC100V	100VDC
AC100V	100V	100-110V	AC380V	346-380V	380V	DC110V	110VDC
AC120V	110-120V	115-120V	AC400V	380-415V	400-440V	DC125V	120-125VDC
AC127V	125-127V	127V	AC440V	415-440V	460-480V	DC200V	200VDC
AC200V	200V	200-220V	AC500V	500V	500-550V	DC220V	220VDC

Note: AC operated coils are the same as those of S-N10 etc., and DC operated coils are the same as those of SD-N11 etc.

4.1.2 Auxiliary Contact Blocks

Type Designation

● Front clip-on types

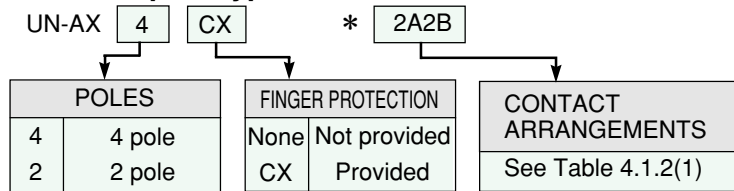

[FOR LOW SIGNAL LEVEL] UN-LL22 CX

FINGER PROTECTION	
None	Not provided
CX	Provided

● Side clip-on types

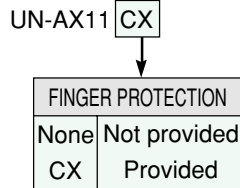

Note: Mark * indicates a blank space.

Ratings and characteristics

Table 4.1.2 (1)

Type	UN-	AX2 (CX)	AX4 (CX)	AX11(CX)	LL22 (CX)		
Applicable contact arrangements		2NO 1NO+1NC 2NC	4NO 3NO+1NC 2NO+2NC	1NO+1NC	1NO+1NC [Standard]	1NO+1NC' [Low level]	
Rated insulation voltage	V	690				250	
Conventional free air thermal current	lth	A				16	1
Rated operating current	Category AC-15 (coil load)	110VAC	A		6	240VAC 20mA ($\text{COS}\phi \geq 0.95$) 48VDC 100mA ($L/R \leq 1\text{msec}$) Minimum operating current 5VDC 5mA	
		220VAC	A		5		
		440VAC	A		3		
Rated operating current	Category DC-13 (large coil load)	48VDC	A		3		
		110VDC	A		0.8		
		220VDC	A		0.2		
Mechanical life	operations	10 million			2.5 million		
Electrical life	operations	0.5 million			0.5 million		
Permissible ambient temperature/humidity	°C/%RH	-25 to +55/45 to 85					
Switching frequency	operations /hour	1,800					
Conductor size	mm ²	1.0 to 2.5					

Note: 1. Contact reliability may be decreased if it is operated more than 1 million operations

Selection guide & contact arrangements

Table 4.1.2 (2)

Front clip-on types	UN-AX2 2A 2NO	UN-AX2 1A1B 1NO+1NC	UN-AX2 2B 2NC	UN-LL22 standard 1NO+1NC low level 1NO+1NC
	UN-AX4 4A 4NO	UN-AX4 3A1B 3NO+1NC	UN-AX4 2A2B 2NO+2NC	
	Side clip-on types UN-AX11 When mount on left side When mount on right side 1NO+1NC			

Note: Front clip-on types and side clip-on contact block should not be mounted both.

4.1.3 Contact Arrangements of Contactor Relay

Table 4.1.3

With standard contacts		
<p>4NO</p> <p>SR-N4(CX)AC.....V 4A SRD-N4(CX)DC.....V 4A</p>	<p>3NO + 1NC</p> <p>SR-N4(CX)AC.....V 3A1B SRD-N4(CX)DC.....V 3A1B</p>	<p>2NO + 2NC</p> <p>SR-N4(CX)AC.....V 2A2B SRD-N4(CX)DC.....V 2A2B</p>
With big capacity contacts		
<p>4NO</p> <p>SR-N4JH(CX)AC.....V 4A SRD-N4JH(CX)DC.....V 4A</p>	/	<p>2NO + 2NC</p> <p>SR-N4JH(CX)AC.....V 2A2B SRD-N4JH(CX)DC.....V 2A2B</p>
With late break contacts		
/	<p>3NO + 1NC (late break)</p> <p>SR-N4LC(CX)AC.....V 3A1B SRD-N4LC(CX)DC.....V 3A1B</p>	<p>2NO + 2NC (late break)</p> <p>SR-N4LC(CX)AC.....V 2A2B SRD-N4LC(CX)DC.....V 2A2B</p>
With mechanical latching		
<p>4NO</p> <p>SRL-N4 AC.....V 4A SRLD-N4 DC.....V 4A</p>	<p>3NO + 1NC</p> <p>SRL-N4 AC.....V 3A1B SRLD-N4 DC.....V 3A1B</p>	<p>2NO + 2NC</p> <p>SRL-N4 AC.....V 2A2B SRLD-N4 DC.....V 2A2B</p>

4.1.4 Spare Coils & Accessories

Spare coils and accessories are common with the series S-N contactors.

- Spare coils See Table 1.8.1 (except for Type SRL(D) latched relays)
- Surge absorbers (suppressors) See Table 1.8.6

4.1.5 Outline Dimensions

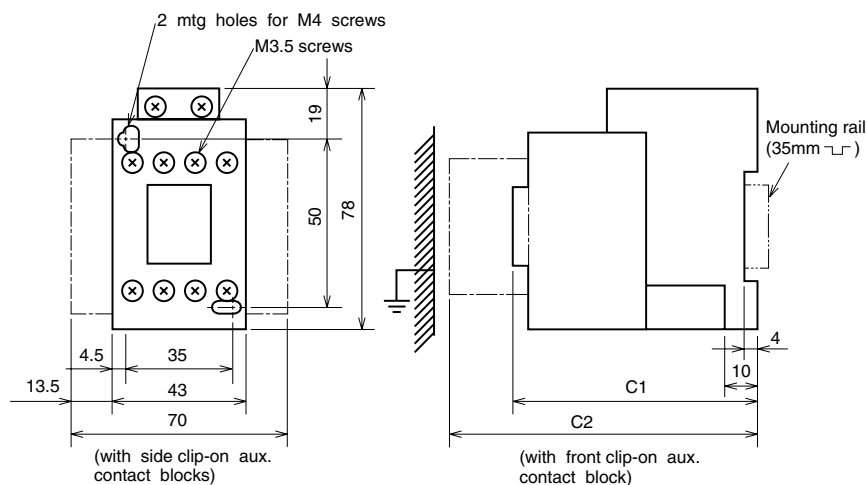

• Key to Dimensions

Model	C1	C2	Mass (kg)
SR-N4(CX)	78	106	0.3
SRD-N4(CX)	110	138	0.62
SRL-N4(CX) SRLD-N4(CX)	134	-	0.45

Note: Front clip-on and side clip-on contact block should not be mounted both.

4.2 Voltage Detection Relays



SRE-AA

The MITSUBISHI series SRE relays are specially designed for voltage sensing. The type SRE-A is specially designed for the detection of undervoltage or overvoltage conditions. The type SRE-K is particularly useful for the switching of automatic transfer panels. The type SRE-K can detect undervoltage by simply connecting to the power-source terminals.

■ Features

- High sensibility
- High reliability
- Easy wiring
- High surge tolerance
- Wide detective voltage range

Type Designation

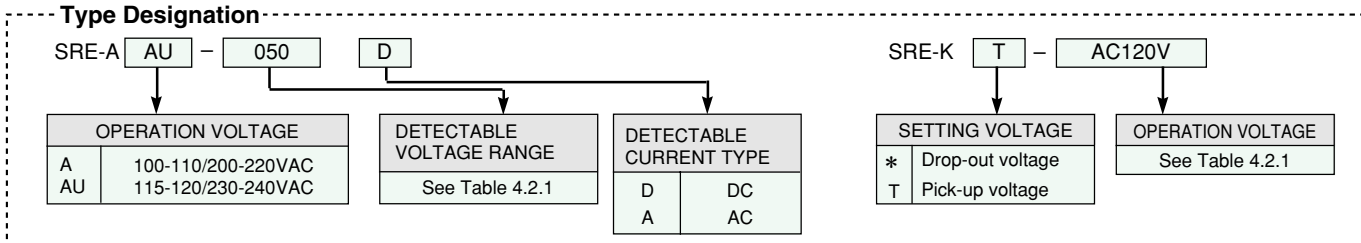

■ Specifications

● Selection table

Table 4.2.1

Type		Detectable voltage range	Permissible input voltage (continuous)	Input impedance	Operation voltage	
SRE-AA SRE-AAU	0P5D	0.1-0.5VDC	± 100VDC	20KΩ	Type SRE-AA 100-110V 50/60Hz 200-220V	
	1P5D	0.3-1.5VDC	± 100VDC	50KΩ		
	005D	1- 5VDC	± 150VDC	100KΩ		
	015D	3-15VDC	± 150VDC	100KΩ		
	050D	10-50VDC	± 200VDC	500KΩ		
	150D	30-150VDC	± 300VDC	800KΩ		
	250D	50-250VDC	± 300VDC	800KΩ		
	015A	3-15VAC	150VAC	100KΩ		Type SRE-AAU 115-120V 50/60Hz 230-240V
	050A	10-50VAC	200VAC	500KΩ		
	150A	30-150VAC	300VAC	800KΩ		
250A	50-250VAC	300VAC	800KΩ			
SRE-K	AC100V	75-105VAC	120VAC	Input 1.8VA	100-110V,50/60Hz	
	AC120V	90-125VAC	132VAC		115-120V,50/60Hz	
	AC200V	150-210VAC	240VAC		200-220V,50/60Hz	
	AC240V	180-250VAC	264VAC	Input 1.7W	230-240V,50/60Hz	
	DC 12V	9-12.5VDC	14VDC		12VDC	
	DC 24V	18-25VDC	28VDC		24VDC	
SRE-KT	AC100V	80-115VAC	120VAC	Input 1.8VA	100-110V,50/60Hz	
	AC120V	95-130VAC	132VAC		115-120V,50/60Hz	
	AC200V	160-230VAC	240VAC		200-220V,50/60Hz	
	AC240V	190-260VAC	264VAC		230-240V,50/60Hz	
	DC 12V	10-14VDC	14VDC	Input 1.7W	12VDC	
	DC 24V	20-28VDC	28VDC		24VDC	
	DC100V	80-115VDC	120VDC		100VDC	

Note: The type SRE-A □ D, for DC detection can be used for full-wave rectification voltage.

● Operating Condition

Fig 4.2.1

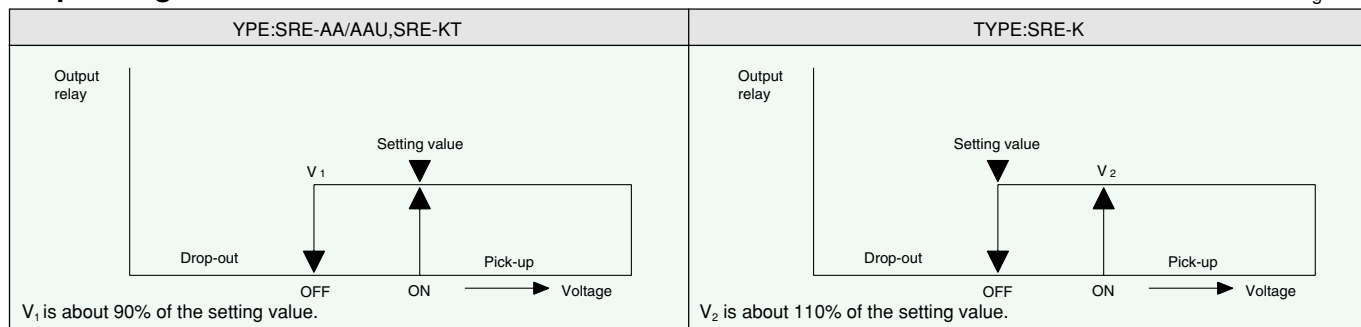

● Ratings and characteristics

Table 4.2.2

Type				SRE-A	SRE-K
Output contact arrangement				1 changeover	
Conventional free air thermal current			lth	A	3
Rated operating current of output contact	Category AC-15	110VAC	A	1.5	
		220VAC	A	1.0	
	Category DC-13	24VDC	A	1.0	
		110VDC	A	0.2	
Accuracy	Repetitive operation ¹		%	±1	
	Control voltage fluctuation		%	±1.5	—
	Ambient temperature change		%	±2.5	
Response time(at 150% of the rated voltage)			msec	100 to 200	
Mechanical life			operations	10 million	
Electrical life			operations	0.25 million	
Permissible ambient temperature/humidity			°C/ %RH	-10 to +55/max. 85	
Power consumption			VA	2	
Operation voltage tolerance (ambient temperature 40°C)			%	85 to 110	—
Withstand voltage			VAC	1500 [1 minute]	
Insulation resistance (500VDC insulation tester)			MΩ	min. 100	
Vibration resistance		10 to 55Hz	m/s ²	19.6	
Shock resistance		10msec half sine wave	m/s ²	98	

Note: 1. Repetitive operation accuracy (%) = $\pm \frac{1}{2} \times \frac{\text{max. measurement} - \text{min. measurement}}{\text{max. scale value}} \times 100$.

■ Wiring precautions

Fig 4.2.2

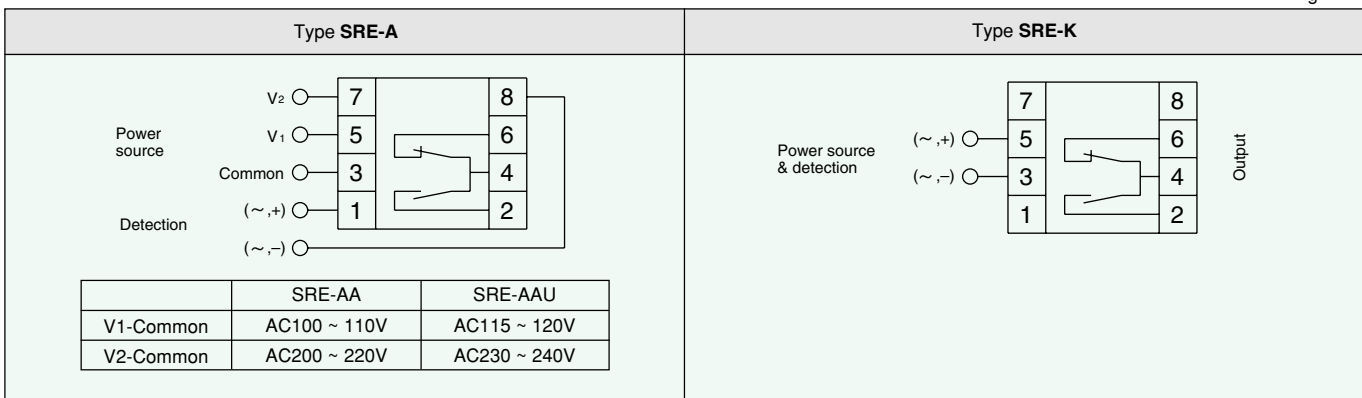

■ Outline dimensions

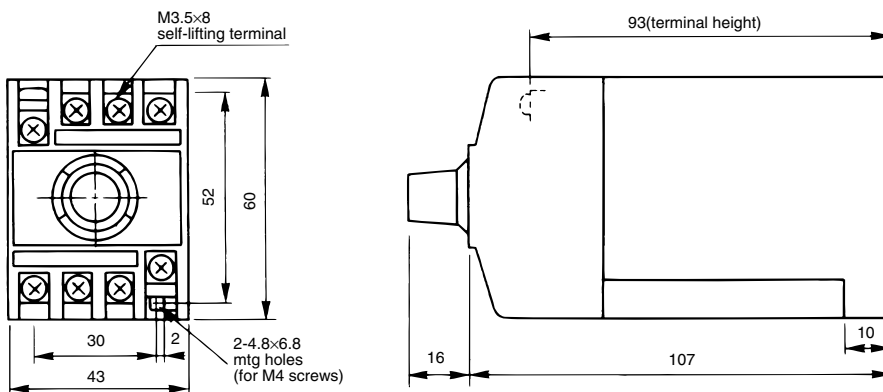

4.3 Re-Starting Relay



UA-DL2 with PF-08RM

The MITSUBISHI series UA-DL re-starting relays are specially designed for automatic re-starting. When the power recovers from an instantaneous power failure or voltage drop the UA-DL re-starts the stopped equipment or machines.

■ Features

- Easy installation and easy wiring
- Compact design
- Versatility of the control voltage (100VAC & 200VAC)
- Indicator lamp is provided.
- Selectable permissible max. power failure time (1sec. & 2sec.).

Type Designation

UA-DL2 * AC100/200V

CONTROL VOLTAGE	
Ordering designation	Rated control voltage (50/60Hz)
AC100/200V	100-110/200-220VAC
AC120V	100-110/110-120VAC
AC240V	200-220/220-240VAC

SOCKETS type: PF-08RM/08TM

See page 66

Notes: 1. DC control voltage type is not available.
2. Mark * indicates a blank space.

■ Specifications

● Ratings & characteristics

Table 4.3.1

Output contact arrangement			1 NO	
Rated operating current of output contact	Category	110VAC	A	1.5
	AC-15	220VAC	A	1.0
Selection of permissible max. power failure time			sec.	1 and 2
Accuracy	Set permissible power failure time		%	-20 to +50 (when 100VAC/200VAC is applied)
	Control voltage fluctuation		%	±35
	Ambient temperature change		%	±25
Minimum energizing time			sec.	5
Electrical life			operations	0.5 million
Permissible ambient temperature/humidity			°C/ %RH	-10 to +55/max. 85
Control voltage tolerance			%	85 to 110 (rated control voltage)
Power consumption			VA	3
Vibration resistance		10 to 55Hz	m/s ²	19.6
Shock resistance		10 msec. half sine wave	m/s ²	98
Withstand voltage			VAC	2000 (50/60Hz 1min.)
Insulation resistance			MΩ	min. 100

Note: 1. When shipping, permissible power failure is set to 2 secs.

When the required re-setting time is 1 sec., please turn the time setting dial to left until it stops.

When you want the permissible power failure time longer than 2 sec., please consult with MITSUBISHI.

● Connection diagrams

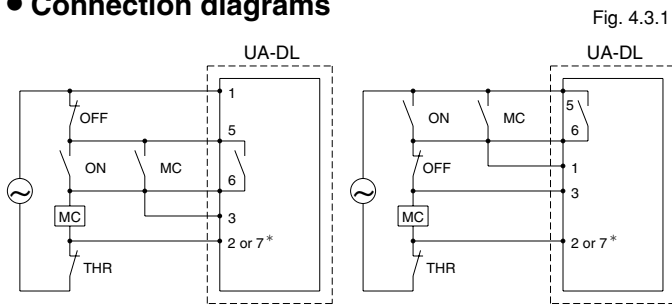

Connection of control switch differs in the above 2 connection diagrams.

* Selection table of terminals

Table 4.3.2

Control voltage	AC100/200V	AC120V	AC240V
Terminal No.			
2	100-110VAC	100-110VAC	200-220VAC
7	200-220VAC	110-120VAC	220-240VAC

1. The terminal (2) and (7) connections differ according to the control circuit voltage. Connect according to the circuit voltage. (Refer to connfarm, above Table 4.3.2)
2. The external switch (OFF push-button switch in connection diagram) which issues the OFF command requires an OFF time of 50ms or more.
3. When using a relay contact instead of the push-button switch (OFF), use a contact that does not open when the power fails. If the push-button switch (OFF) section opens, UA-DL2 will turn OFF, and the magnetic contactor will not restart.
4. An electrolytic capacitor is used, so periodically check the operation time.

● Operation characteristics

Fig. 4.3.2

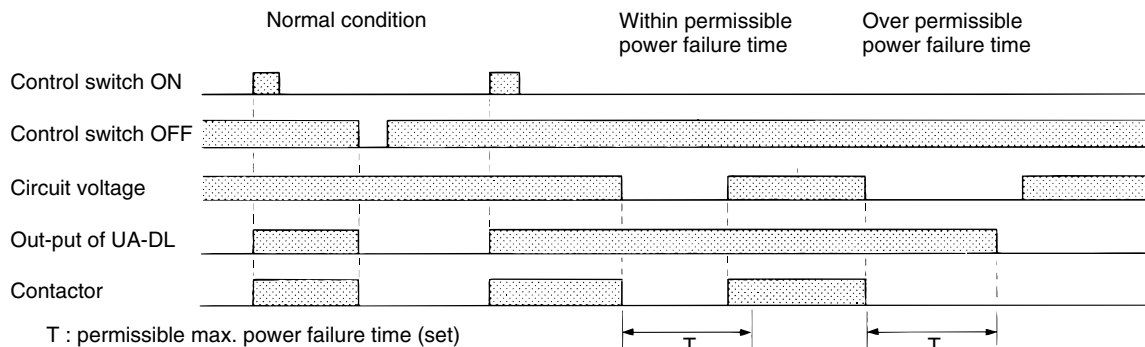

■ Outline Dimensions

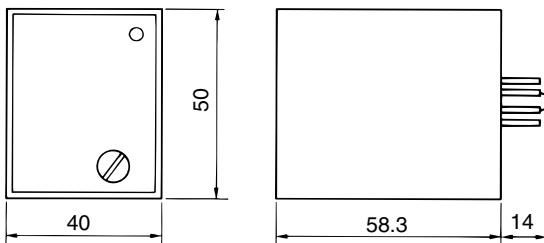

UA-DL2 (Mass: 0.1kg)

Note: 2 pcs of locking springs are enclosed in the each package of UA-DL.

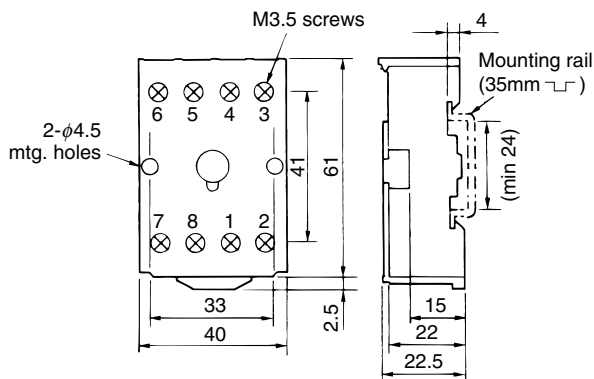

PF-08RM (Mass: 0.05kg)

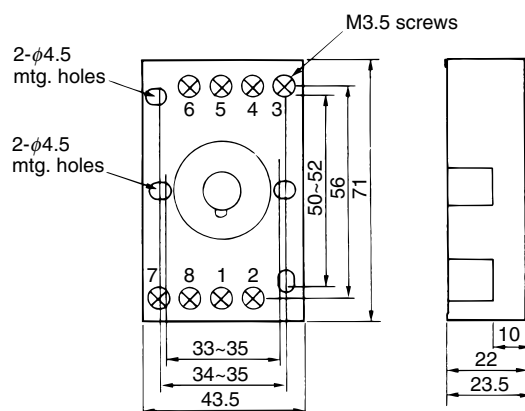

PF-08TM (Mass: 0.05kg)

4.4 Solid State Time Delay Relays

Series **SRS-H**



SRS-HNPS

The MITSUBISHI series SRS-H solid state time delay relays are specially designed for high accuracy and easy mounting.

■ Features

- High accuracy
- Compact design
- High reliability
- Easy mounting (for direct panel mounting or mounting on 35mm rail)
- With finger protection (terminal cover) model is available
- 1 delayed & 1 instantaneous changeover contact for ON-delay relay.

Type Designation

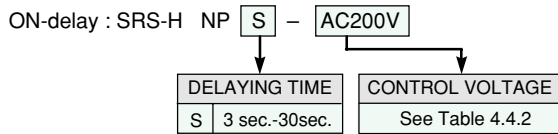

■ Specifications

• Time delay selection

Table 4.4.1

Relay type		Adjustable time range	Contacts
ON-delay	SRS-HNPS	3 sec. - 30 sec.	1 delayed and 1 instantaneous changeover

• Control voltages

Table 4.4.2

Ordering designation	Rated voltage
AC100V	100-120V 50/60Hz
AC200V	200-240V 50/60Hz
AC400V	380-440V 50/60Hz

• Rating & characteristics

Table 4.4.3

Type		ON-delay	
Conventional free air thermal current		A	2
Rated operating current	Category 120VAC	A	1.5
	AC-15 240VAC	A	1
	440VAC	A	0.3
Accuracy	Repetitive operation	%	±0.5
	Control voltage fluctuation	%	±1
	Ambient temperature change	%	±5
Minimum pause time		msec.	100
Mechanical life		operations	10 million
Electrical life		operations	0.1 million
Permissible ambient temperature		°C	-10 to 55
Permissible ambient relative humidity		%RH	45 to 80
Control voltage tolerance		%	85 to 110 (rated control voltage)
Power consumption	Control voltage AC	VA	5 (AC100V/AC200V) 10 (AC400V)
Vibration resistance		10-55Hz m/s ²	19.6
Shock resistance		10msec half sine wave m/s ²	49
Withstand voltage		[live parts to ground] VAC	2000 (1 min.)

• Internal wiring

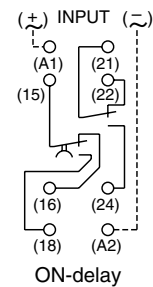

■ Outline Dimensions

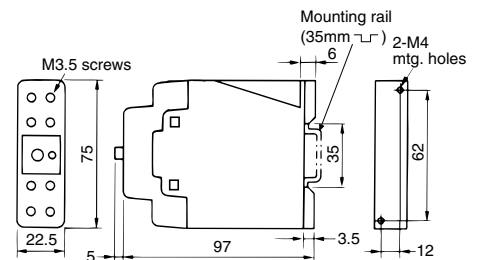

SRS-HNPS (Mass: 0.15kg)

4.5 Pneumatic Time Delay Relays

Series SRT-N



The MITSUBISHI series SRT pneumatic time delay relays are designed for general purpose time delaying, such as star-delta starters and transfer panels.

■ Features

- Easy delaying time adjustment
- High contact reliability: By using bifurcated moving contacts, contact performance has been made more reliable than ever.
- Finger protected types are available
- Manual testing
- 2 delayed contacts (1NO1NC) & 4 instantaneous contacts (2NO2NC)
- Can be mounted on 35mm rail

SRT-NN

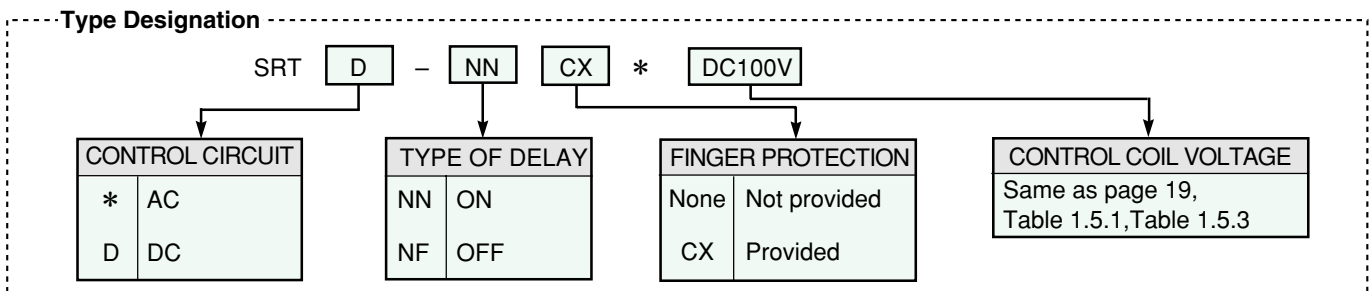

Note: Mark * indicates a blank space.

■ Specifications

● Ratings & characteristics

Table 4.5.1

Adjustable delay time range		sec.	0.1 to 60	
Type of contacts		-	Delayed	Instantaneous
Conventional free air thermal current I _{th}		A	10	16
Rated operating current	category	110VAC	A	5
		220VAC	A	3
	AC-15	440VAC	A	1
		550VAC	A	1
	category	110VAC	A	6
		220VAC	A	4
AC-12	440VAC	A	1.5	
	550VAC	A	1.5	
category	24VDC	A	1	
	48VDC	A	0.5	
	110VDC	A	0.3	
DC-13	110VDC	A	0.3	
	220VDC	A	0.15	
category	24VDC	A	2	
	48VDC	A	1	
	110VDC	A	0.6	
DC-12	110VDC	A	0.6	
	220VDC	A	0.3	
Rated insulation voltage		VAC	660	
Mechanical life		operations	1 million	
Electrical life		operations	1 million	0.5 million
Repeat accuracy		%	±10	
Min. pause time		msec.	500	
Min. energizing time	AC operated	msec.	15	
	DC operated	msec.	30	
Permissible ambient temperature		°C	-5 to 55	
Control coil voltage tolerance		%	85 to 110	
Make and break capacity (at rated operating current)	AC	times	11	
	DC	times	2	
Average operating times	AC operated	Make	msec.	11
		Break	msec.	10
	DC operated	Make	msec.	45
		Break	msec.	10
Coil consumption	AC operated	Inrush	VA	50
		Sealed	VA	10
	DC operated	W	7	
Switching frequency		operations /hour	1,800	
Vibration resistance		10-55Hz	m/s ²	19.6
Shock resistance		10msec. half sine wave	m/s ²	49
Conductor size			mm ²	1.0 to 2.5

■ Contact arrangement

Table 4.5.2

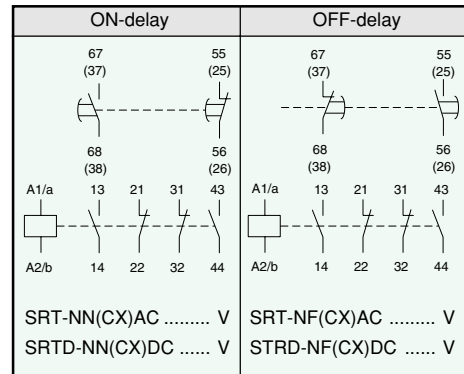

- Notes: 1. 13-14, 43-44 Instantaneous NO contacts
 23-24, 33-34 Instantaneous NC contacts
 55-56, 65-66 Delayed NC contacts
 57-58, 67-68 Delayed NO contacts
 2. Aux. contact block should not be mounted.

● Delay time characteristics

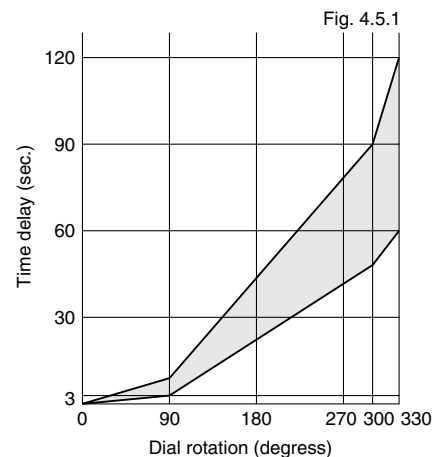

Pneumatic Time Delay Modules



UN-TR4AN

Type UA-TR pneumatic time delay modules are designed for attachment to series S-K contactors and SR-K contactor relays.

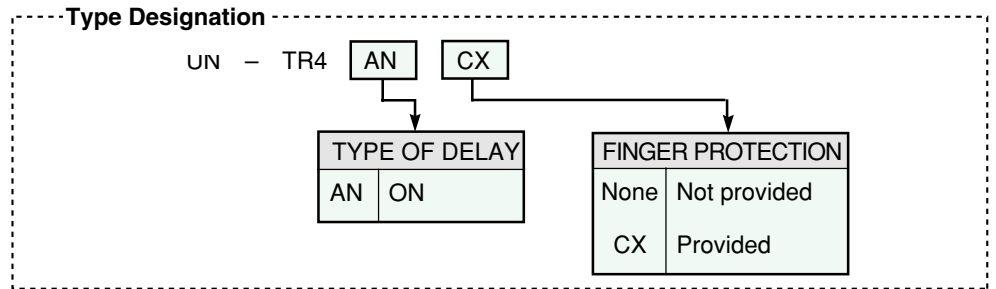

Applicable contactor and relay selection

Table 4.5.3

Type	Type of delay	Applicable contactors and relays	
UN-TR4AN(CX)	ON delay	AC operated	S-N10(CX), N11(CX), N18(CX) SR-N4(□□)(CX)
		DC operated	SD-N11(CX) SRD-N4(□□)(CX)

Note: When this module is mounted, aux. contact block should not be mounted.

Contact arrangement

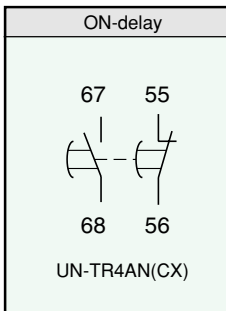

Note: 55-56 Delayed NC contacts
67-68 Delayed NO contacts

Ratings & characteristics

..... See delayed contacts of Table 4.5.1

Delay time characteristics

..... See Fig.4.5.1

Key to Dimensions

Type	A	B	Mass(kg)
SRT-NN(CX), -NF(CX)	121.5	-	0.36
SRTD-NN(CX), -NF(CX)	153.5	-	0.68
UN-TR4AN(CX)	-	48.5	0.06

Outline Dimensions

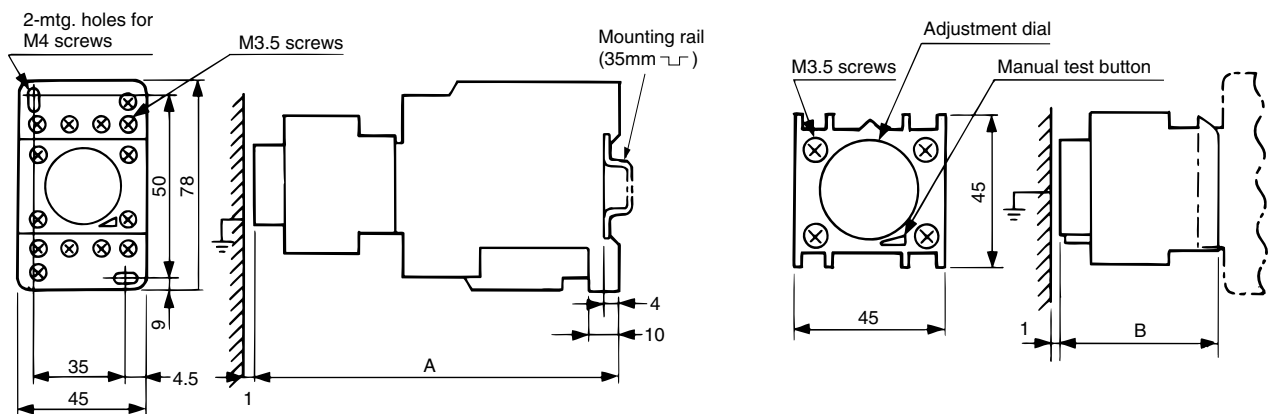

5. STAR-DELTA STARTERS

Series EYD-N



EYD-N35

The MITSUBISHI series EYD-N star-delta starters are generally suitable for squirrel-cage motors of 4kW to 250kW which can be started at no-load or reduced load during starting, the motor is star-connected, reducing current and torque to 1/3 of direct-on-line starting values.

So the voltage drop, due to starting current, can be reduced. Series EYD-N star-delta starters are the simplest and cheapest methods of all reduced-voltage starting methods. Series EYD-N star-delta starters comprise three contactors (for running, delta operation and star operation), one thermal overload relay and one time-delay relay (series SRS-H, solid-state time delay relay). The star-delta changeover time is set to 10 sec when shipped, but is easily adjustable from 3 sec. to 30 sec. The O.L.R. heater is set at the heater designation value (following) when shipped, and be sure to re-set to suit the motor full-load current in the field.

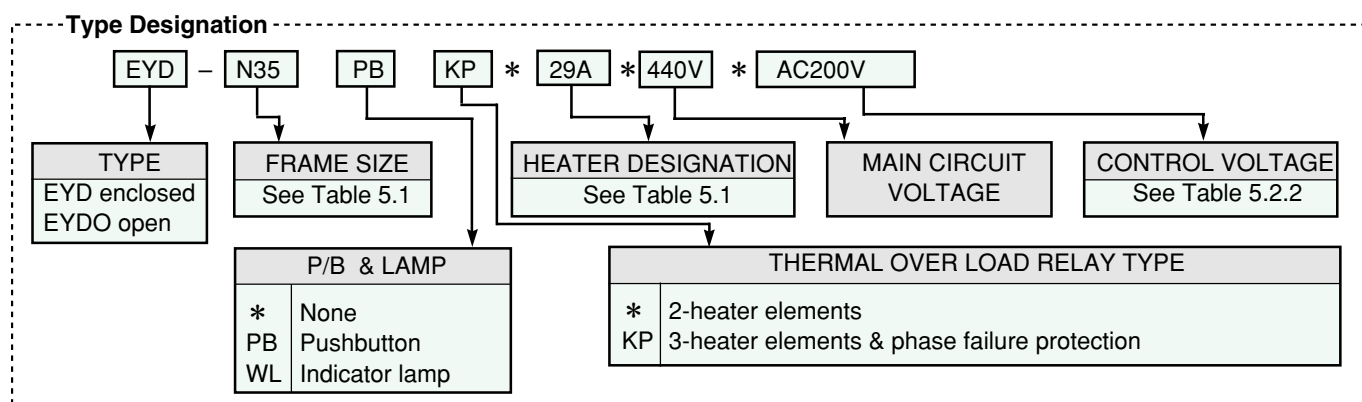

Note: Mark * indicates a blank space

5.1 Selection Table

Table 5.1

Rated 3-phase motor capacity				Star-delta starter Type EYD(O)–	Heater designation A	Setting range A	Components ¹		
220-240VAC		380-440VAC					Running & delta contactors	Star contactor	Thermal O.L.R
kW	HP	kW	HP						
11	15	18.5	25	N20(KP)	35	30~40	S-N20	S-N20	TH-N60(KP)
18.5	25	30	40	N35(KP)	54	43~65	S-N35	S-N20	TH-N60(KP)
22	30	45	60	N50(KP)	82	65~100	S-N50	S-N20	TH-N120(KP)
30	40	55	75	N65(KP)	105	85~125	S-N65	S-N25	TH-N120TA(KP)
45	60	75	100	N80(KP)	125	100~150	S-N80	S-N25	TH-N120TA(KP)
–	–	90	125	N95(KP)	150	120~180			
55	75	–	–		180	140~220	S-N95	S-N35	TH-N220HZ(KP)
62	85	110	150	N125(KP)	180	140~220	S-N125	S-N50	TH-N220HZ(KP)
75	100	132	180	N150(KP)	210	170~250	S-N150	S-N50	TH-N220HZ(KP)
110	150	220	300	N220(KP)	330	260~400	S-N220	S-N65	TH-N400HZ(KP)
160	220	250	340	N300(KP)	500	400~600	S-N300	S-N125	TH-N600(KP) ²

Notes: 1. Time delay relays are all SRS-HNPS.

2. TH-N600(KP) and current transformer, CW-15L or CW-15LM (by MITSUBISHI).

5.3 Outline Dimensions

5.3.1 Open Type

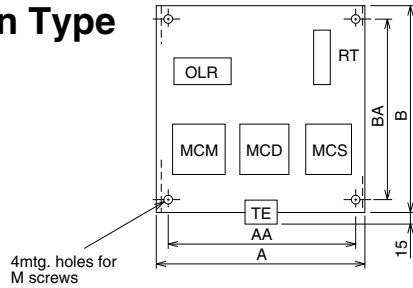

Type EYDO-N20, N35

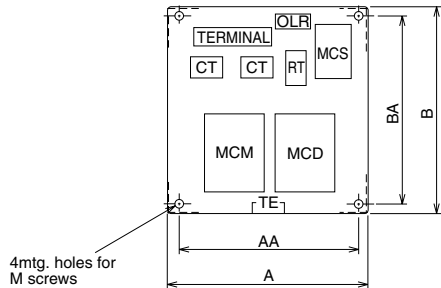

Type EYDO-N300, N400

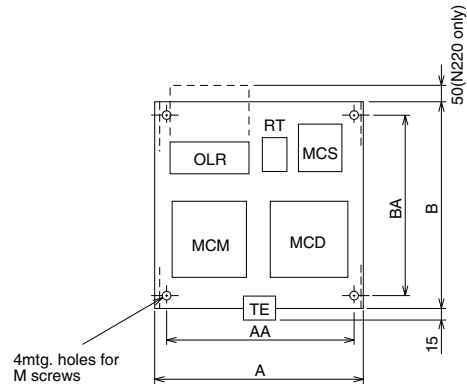

Type EYDO-N50~N220

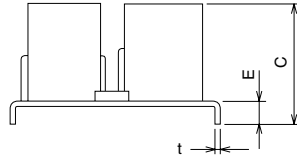

● Dimensions

Table 5.3.1

Type	A	B	C	AA	BA	E	M	t	Mass (kg)
EYDO-N20	230	220	114	200	200	12	M6	2.3	4
EYDO-N35	270	270	114	250	250	12	M6	2.3	5
EYDO-N50	270	270	118	250	250	12	M6	2.3	5.5
EYDO-N65	270	270	118	250	250	12	M6	2.3	5.5
EYDO-N80	270	270	140	250	250	12	M6	2.3	7
EYDO-N95	380	430	180	350	400	15	M8	3.2	11
EYDO-N125	380	430	180	350	400	15	M8	3.2	13
EYDO-N150	380	430	189	350	400	15	M8	3.2	14
EYDO-N220	380	430	189	350	400	15	M8	3.2	21
EYDO-N300	600	600	210	550	550	15	M12	3.2	42
EYDO-N400	600	600	210	550	550	15	M12	3.2	42

5.3.2 Enclosed Type

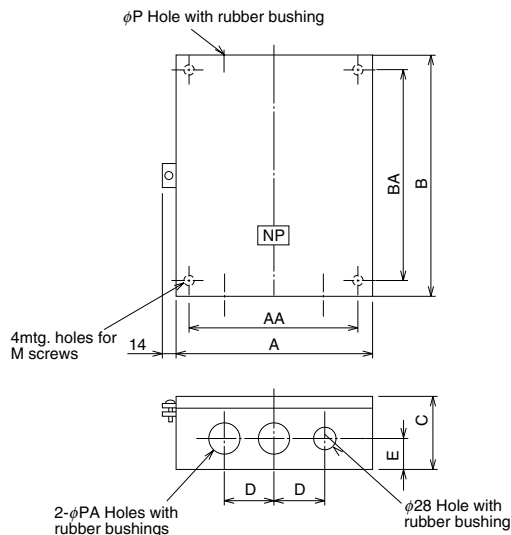

Type EYD-N20~N220

● Dimensions

Table 5.3.2

Type	A	B	C	AA	BA	D	E	M	P	PA	Mass (kg)
EYD-N20	260	360	165	200	300	75	60	M6	40	28	7
EYD-N35	310	460	165	250	400	75	60	M8	52	40	9
EYD-N50	310	460	165	250	400	75	60	M8	52	40	10
EYD-N65	310	460	165	250	400	75	60	M8	52	40	10
EYD-N80	310	460	165	250	400	75	60	M8	52	40	12
EYD-N95	460	660	225	400	600	125	80	M12	78	62	24
EYD-N125	460	660	225	400	600	125	80	M12	78	62	26
EYD-N150	460	660	225	400	600	125	80	M12	78	62	28
EYD-N220	460	660	225	400	600	125	80	M12	78	62	34

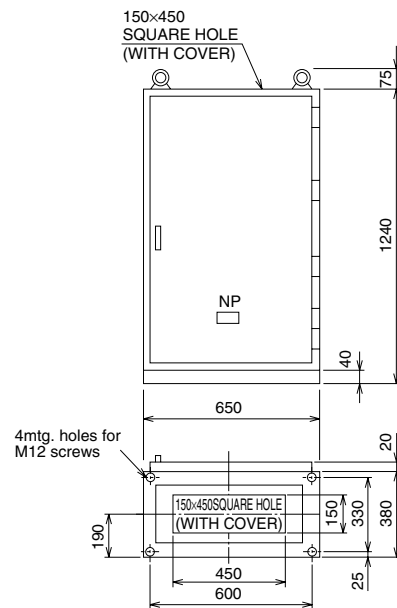

Type EYD-N300, N400 (Mass 120kg)

6. SOLID STATE CONTACTORS

6.1 Features

■ US-N/K Series (for motor/heater load)

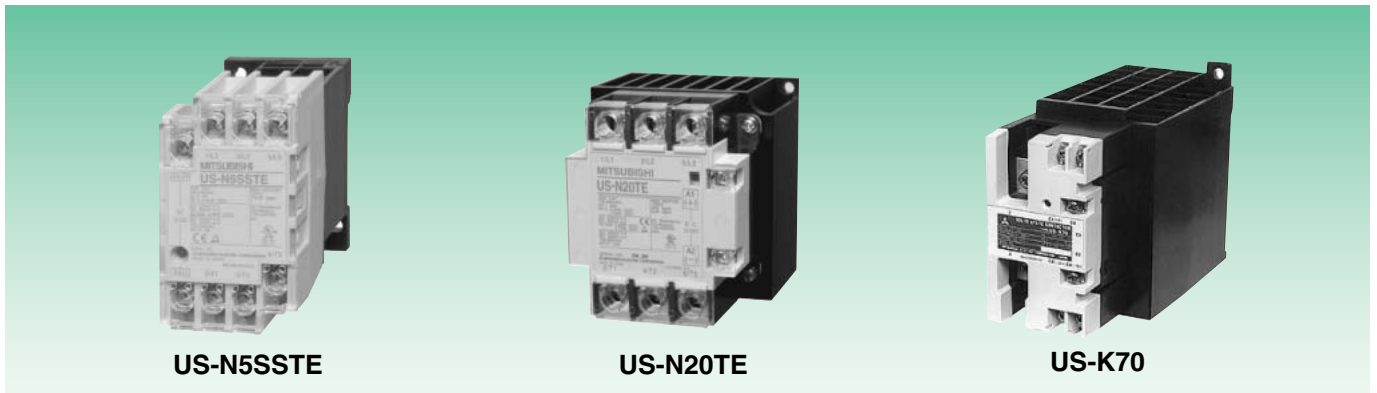

High-accuracy opening/closing, maintenance-free

With no electrical or mechanical wear sections, this type is a suitable maintenance-free selection for high-accuracy opening/closing (motor, heater, light, capacitor switching, etc.)

No sound noise, clean operation

The best suitable for applications that reduce to avoid sound noise (Ex.: hotels, hospitals, offices, or clean rooms, etc.).

Applicable to a wide range of main circuit voltage (US-N20(TE) to US-N50(TE))

Can be used with a wide main voltage range from 100 to 480VAC.

Conformity to International Standards (US-N Series)

The standard model complies with or is approved to be compliant with not only domestic standards but also various overseas standards.

Standard installation protection cover for live part location to improved safety (US-N Series)

A live part location protection cover, with finger protection complying with DIN and VDE Standards, is provided as a standard to improve safety.

Various line up and series

<Heater load>

- 2-circuit, 3-circuit integrated type
- Cycle control type power adjuster

<Motor load>

- 2-circuit, 3-circuit integrated type

<Current frame>

- 200VAC 5A to 200A frame
- 400VAC 20A to 200A frame

■ US-H Series (for heater load)



Best suitable for heater loads

Suitable for high-accuracy opening/closing applications such as injection molding machines and semiconductor manufacturing machines, etc.

Applicable to a wide range of main circuit voltage

Can be used with a wide main voltage range from 24 to 480VAC.

Conformity to International Standards

The standard model complies with or is approved to be compliant with not only domestic standards but also various overseas standards.



Live part location protection cover available for improved safety (option)



A live part location protection cover (Type UN-CV501US) can be easily mounted after the control cabinet is mounted to improve safety.





6.2 Product Scope







■ US-N/K • US-H Series Models







Table 1. US-N type, US-K type solid state contactors (standard model)

200VAC class (100 to 240VAC)	AC-1 class rated operating current (A) (Note 5)	5	8	20	30	40	50	70		
	Heater capacity (kW)	1 φ 200V (Note 2)	1	1.6	4	6	8	10	14	
		3 φ 200V	1.7	2.7	6.9	10.3	13.8	17.3	24.2 (Note 1)	
	Maximum motor capacity (kW)	0.4	0.4	2.2	3.7	5.5	5.5	11 (Note 1)		
	For three-phase load US-N□ US-K□		US-N5SS US-N5SSTE	US-N8SS US-N8SSTE	US-N20 US-N20TE	US-N30 US-N30TE	US-N40 US-N40TE	US-N50 US-N50TE	US-N70NS US-N70NSTE	
For single-phase load For three-phase load (using two or three) US-K□									US-K70	

400VAC class (200 to 440VAC)	AC-1 class rated operating current (A) (Note 5)			20	30	40	50	70	
	Heater capacity (kW)	1 φ 400V (Note 2)		8	12	16	20	28	
		3 φ 400V		13.8	20.7	27.7	34.6	48.5 (Note 1)	
	Maximum motor capacity (kW)			3.7	7.5	7.5	15	22 (Note 1)	
	For three-phase load US-N□ US-NH□ US-KH□				US-N20 US-N20TE	US-N30 US-N30TE	US-N40 US-N40TE	US-N50 US-N50TE	US-NH70NS US-NH70NSTE
For single-phase load For three-phase load (using two or three) US-KH□									US-KH70

Mounting on 35mm rail	Possible with standard product	(Note 4)	
Protection cover for live part location	Mounted as a standard part (Not mounted for US-K70 or KH70)		
Driving unit		UA-DR1	
Driving unit with output	UA-SH8 (Note 6)	UA-SH1	
Reversing unit	UA-RE		
Fault detecting unit	UN-FD (for main circuit 200V), UN-FD4 (for main circuit 400V)		
Power control unit	UA-PC		
Options (Note 3)			
	UA-SH8	UA-DR1	UA-SH1
			
			UA-RE

	80	100	120	150	200
	16	20	24	30	40
	27.7	34.6 (Note 1)	41.5	52 (Note 1)	69 (Note 1)
	11	15 (Note 1)	15	18.5 (Note 1)	22 (Note 1)
	 US-N80NS US-N80NSTE	 US-K100TE	 US-K120TE	 US-K150TE	
		 US-K100		 US-K150	 US-K200

	80	100	120	150	200
	32	40	48	60	80
	55.4	69.3 (Note 1)	83	103.9 (Note 1)	138.5 (Note 1)
	22	30 (Note 1)	30	37 (Note 1)	45 (Note 1)
	 US-NH80NS US-NH80NSTE	 US-KH100TE	 US-KH120TE	 US-KH150TE	
		 US-KH100		 US-KH150	 US-KH200



UN-FD



UA-PC

Table 2. US-K type solid state contactor (for DC load)

Direct current	DC-1 class rated operating current (A)		8
	Rated voltage		DC24~110V
	For DC load US-KD8		 US-KD8
	Option	Driving unit with output	UA-SH8
Mounting on 35mm rail			Possible with standard product

Note 1. For the US-K(H)□ type, the capacity when applied for a three-phase load using two or three US-K(H)□ type units for the single-phase load is shown.

Note 2. This is the capacity per pole.

Note 3. □ in the option unit field indicates the applicable range.

Note 4. Possible with a dedicated part (US-□RM).

Note 5. If ambient temperature is higher than 40°C, the derating factor shown in Fig.1 should be applied to the rated operating current.

Note 6. When installing the output driving unit UA-SH8 type onto the US-N5SS/N8SS (TE) type, remove the US-N□ type unit's cover first.

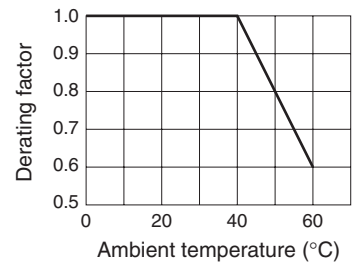

Fig.1

■ US-H Series Models

Solid state contactor for heater loads, suitable for high-frequency heater switching applications such as injection molding machines and semiconductor manufacturing machines.

Table 3. US-H type solid state contactor

Rated operating current (AC-51) (-10 to 40°C) (Note 1)		20A	30A	40A	50A	20A	30A	40A	50A
Heater capacity (-10 to 40°C) (Note 1)	1 φ 200V	4kW	6kW	8kW	10kW	4kW	6kW	8kW	10kW
	3 φ 400V	6.9kW	10.3kW	13.8kW	17.3kW	—	—	—	—
	3 φ 400V	13.8kW	20.7kW	27.7kW	34.6kW	—	—	—	—
Tolerable maximum current (peak) 60Hz 1 cycle		330A	800A	1000A	1300A	330A	800A	1000A	1300A
Rated operating voltage		AC24V~AC480V 50/60Hz							
Operating voltage range		AC20V~AC528V							
Main circuit control method		Batch control				Individual control			
Standard		US-H20	US-H30	US-H40	US-H50	US-H20DD	US-H30DD	US-H40DD	US-H50DD
									
		US-H20		US-H40		US-H20DD		US-H40DD	
Mounting on 35mm rail		US-H20RM	US-H30RM	—	—	US-H20DDRM	US-H30DDRM	—	—
Options	Fault detecting unit	UN-FD (for main circuit 200V) UN-FD4 (for main circuit 400V)							
	Power control unit	UA-PC							
	Protection cover of live part location	UN-CV501US							

Note:1. If ambient temperature is higher than 40°C, the derating factor shown in fig.2 should be applied to the rated operating current.

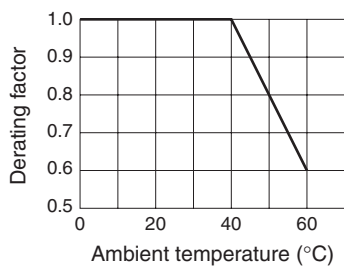

Fig.2

MITSUBISHI ELECTRIC WORLDWIDE SALES NETWORK

Country/Region	Company name and address	Telephone
Australia	Mitsubishi Electric Australia Pty. Ltd., 348 Victoria Road, Rydalmere N.S.W. 2116, Austraria	+61-(0)2-9684-7586
Belgium	Emac S.A., Industrialaan 1, B-1702 Groot-Bijgaarden, Belgium	+32-(0)2-4810211
Chile	Rhona S.A., Varinate Aqua Santa 4211 Vina Del Mar-Chile	+56-32-320652
China	Mitsubishi Electric Automation (Shang Hai) Ltd. 1-3/F., Block 5, 103 Cao Bao Road, Shanghai China	+86-(0)21-6120-0808
Colombia	Inpovarlda Proelectrico, Carrera 43G No.27-12, Medellin, Colombia	+57-1-232-2300
Denmark	Louis Poulsen Co.A/S., Geminivej 32, DK-2670 Greve, Denmark	+45-(0)43-95-95-95
Egypt	Cairo Electrical Group, 9 Rostoum Street, Garden City, Apt.5, P.O.Box : 165-11516 Cairo, Egypt	+20-2-796-1337
Germany	Mitsubishi Electric Europe B.V., German Branch, Gother Strasse 8, 40880 Ratingen, Germany	+49-(0)2102-486-0
Greece	Antonios Drepanias S.A., 52.Arkadias Street GR 12132, Peristeri Athens Greece	+30-(1)57815995781699
Hong Kong	Mitsubishi Electric Automation (Hong Kong) Ltd. 10/F., Manulife Tower, 169 Electric Road, North Point, Hong Kong	+852-2887-8870
Indonesia	P.T.Sahabat Indonesia, Muara Karang Selatan Blok A/Utare No.1, Kav No.11 Kawasan Industri Pergudangan Jakarta Utare 14440	+62-21-661-0651
Ireland	Mitsubishi Electric Europe B.V., Irish Branch, Westgate Business Park, Ballymount, Dublin 24, Ireland	+353-(0)1-450-5007
Italy	Mitsubishi Electric Europe B.V., Italy, C.D. Colleoni-P. Perseolng.2, Via Paracelso 12 1-20041 Agrate Brianza (M1)	+39-(0)396-0531
Korea	Mitsubishi Electric Automation (Korea) Ltd. 2/F., 660-11, Deungchon-Dong, Kangseo-ku, Seoul 157-030, Korea	+822-3660-9607
Kuwait	Salem M. Al-Nisf Electrical Co. W.L.L., P.O.Box 4784 Safat 13048 Safat, Kuwait	+965-481-5282
Lebanon	Comptoir Delectricite Generate-International, Cebaco Center-Block A, Autostrade Dore, P.O.Box 90-953, Beirut-Lebanon	+961-1-240430
Myanmar	Peace Myanmar Electric Co., Ltd., No.137/139, Botataung Pagoda Road, Botataung Town Ship 11161, Yangon, Myanmar	+95-(0)1-202589
Netherlands	Imtech Marine & Industry, Postbox 5054, NI-3008 Ab-Rotterdam, Netherlands	+31-(0)10-487-1911
New Zealand	Melco Sales (N.Z.) Ltd., 1 Parliament Street, Lower Hut1, New Zealand	+644-569-7350
Norway	SCANELECAS, 5074 Godvik-Bergen Leirvikasen 43B, Norway	+47-55-506000
Pakistan	Prince Electric Co., 16 Brandreth Road Lahore 54000, Pakistan	+92-765-4342
Peru	I.T.E., Ingenieros s.a., Paseo de la Republica 3573, Lima 27, Peru	+51-14-41-1825
Philippines	Edison Electric Integrated, Inc., 24TH Floor, Galleria Corporate Center, Edsa cor. Ortigas Ave., Quezon City	+632-634-8691-96
Poland	MPL Technology Sp Zo.o., Ul.Sliczna 36 31-444 Krakow, Poland	+48-(0)12-632-28-85
Saudi Arabia	Center of Electrical Goods, Al-Nabhaniya Street-4th Crossing Al-Hassa Road, P.O. Box 15955, Riyadh 11454, Saudi Arabia	+966-1-477-149
Singapore	Mitsubishi Electric ASIA PTE Ltd. 307 Alexandra Road #05-01/02 Mitsubishi Electric Building Singapore	+65-6473-2308
Slovenia	INEA, Ljubijanska 80, 61230 Domzale, Slovenia	+386-61-718000
South Africa	Circuit Breaker Industries Ltd., Private Bag 2016. Isando 1600, Johannesburg, South Africa	+27-(0)11-928-2000
Spain	Mitsubishi Electric Europe B.V., Spanish Branch, Caretera De Rubi 76-80, 08190-Sant Cugat Del Valles (Barcelona) Spain	+34-(0)93-595-3131
Sweden	Euro Energy Components AB, Energigatan 15 S-43422 Kungsbacka Sweden	+46-(0)300-51800
Switzerland	Trietec A G., Mühlenstrasse 136, 8200 Schaffhausen, Switzerland	+41-52-6258425
Taiwan	Setsuyo Enterprise Co., Ltd., 6th, Fl., Number 105, Wu Kung 3rd Rd, Wu-Ku Hsiang Taipei. Taiwan, ROC	+886-(0)2-2298-8889
Thailand	United Trading & Import Co. Ltd., 77/12 Burmrunmuang Road, Klong Mahanak, Pomprab, Bangkok 10100, Thailand	+66-2-6649647-50
Turkey	HEDEF, Balmumcu-Istanbul Barboros Bulv. Iba Blokleri Gazi Umur P. So Turkey	+90-(0)212-2754876
U.K.	Mitsubishi Electric Europe B.V., UK Branch, Travellers Lane, Hatfield, Herts AL10 8XB, United Kingdom	+44-(0)1707-276100
U.S.A.	Mitsubishi Electric Automation, Inc., 500 Corporation Woods Parkway, Vernon Hills, IC60061, U.S.A.	+1-847-478-2100
Uruguay	Fivia., AV. Uruguay 1274/76 11100 Montevideo Uruguay	+598-2-920808
Venezuela	Adesco S.A., P.O.Box 78034 Caracas 1074A, Venezuela	+58-241-4439
Vietnam	Sa Giang Techno Co., Ltd., 207/4 Nguyen Van Thu St., Dakao Ward, Dist1, Ho Chi Minh City, Vietnam	+84-8-825-6453

Safety tip: Be sure to read the instruction manual thoroughly before using these products.

 **MITSUBISHI ELECTRIC CORPORATION**
HEAD OFFICE: TOKYO BUILDING, 2-7-3, MARUNOUCHI, CHIYODA-KU, TOKYO 100-8310, JAPAN