

Advanced servo technology with optical network

# MELSERVO J3



Mitsubishi Electric Corporation Nagoya Works is a factory certified for ISO14001 (standards for environmental management systems) and ISO9001 (standards for quality assurance management systems)



# MELSERVO-J3 The ever-evolving new

## Able to realize high speed with high accuracy

### ■ Tact time improved with high-speed positioning

- High-speed, high-torque motor HF series  
\*Patent pending

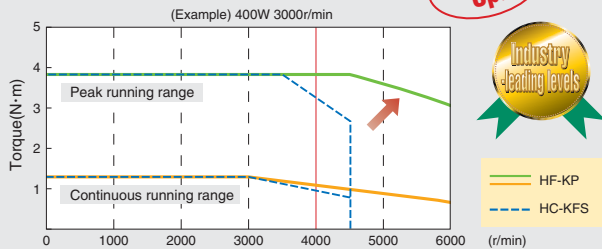

Power Up!



- The high speed (6000r/min) and high-function speed frequency response (900Hz) shorten positioning times.

Higher speed!

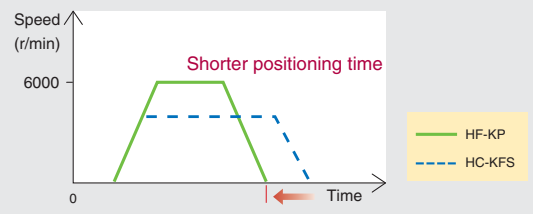

- Maximum speed has been increased to 6000r/min for the HF-MP/HF-KP series, and 3000r/min for the HF-SP□2 series.

### ■ Machine performance improved with highly accurate operation

- A high-resolution encoder 262144p/rev (18-bit) is mounted as standard to realize stability even at low speeds.
- Fluctuations in motor torque are reduced by reducing the cogging torque.



<Cogging torque> (Note 1)

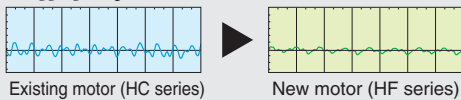

1/2 of existing products

- The absolute encoder is standard equipment. Home position return at each power on is not necessary if the battery (MR-J3BAT) is mounted on the servo amplifier.

## Compact and flexible

### <Servo amplifier>

- Installation area is 40% smaller than existing model (compared with 400W)

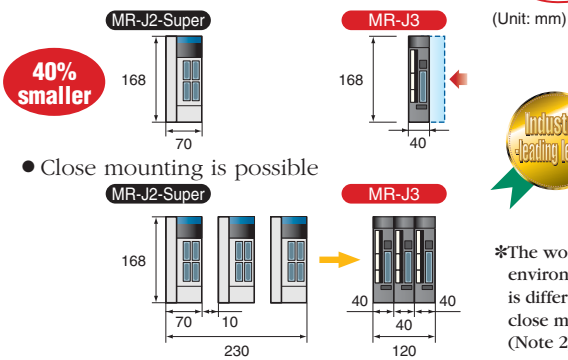

More compact!

### <Servo motor>

- 20% smaller than the existing model (Example: HF-MP/HF-KP series 400W)

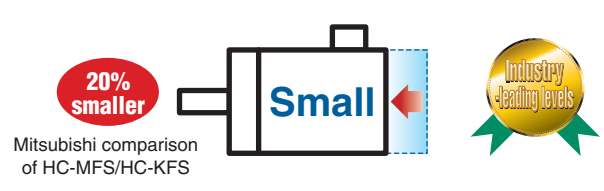

Even smaller!

### <Servo motor>

- The connectors of the HF-SP series are smaller than those of the existing HC-SFS series, so the user's system can be even more compact.

### ■ Flexible wiring

- Connectors have been adapted for the servo amplifier terminal block thereby reducing the time required for wiring. Refer to the section "Peripheral Equipment" in this catalog for details regarding the connectors. (Only for the MR-J3-350□ or smaller servo amplifier.)

- The cable mounting direction is changeable to either in a direction or an opposite direction of the motor shaft according to the selected cable. (HF-MP/HF-KP series)

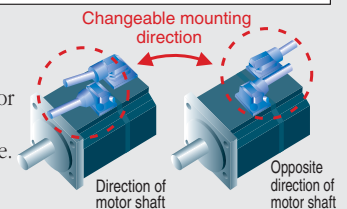

## Environmental safety

### ■ Improved environmental safety

- IP65 is conformed as standard for the servo motor HF-MP/HF-KP series (excluding the shaft-through portion). (Note 3)
- IP67 is conformed as standard for the servo motor HF-SP series (excluding the shaft-through portion).



## Compatible with global standards

### ■ Conformity to EN, UL and cUL standards

MELSERVO-J3 conforms to global standards.

\* This product is not subject to China Compulsory Certification (CCC).



Notes: 1. This data is for 750W.  
2. Refer to the sections "Amplifier Specifications" and "Cautions Concerning Use" in this catalog for details.  
3. Use IP65 compatible cables when using the motor in an IP65 environment.

# generation servo



## Advanced and evolving tuning functions

### ■ Easy tuning - Gain adjustment is not necessary -

Ever-evolving Real time Auto-tuning



#### Detailed setting of the response value now possible!

With Mitsubishi's original model adaptive control and the ever-evolving auto-tuning function, tuning can be completed just by changing the response setting value!!

### ■ Precise tuning

#### ● To suppress vibration at the end of the arm or the residual vibration in the machine

##### Advanced Vibration Control

\*Patent pending

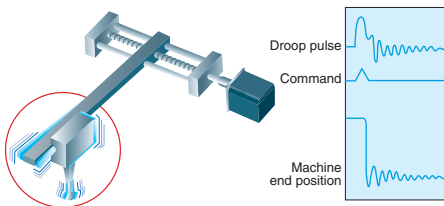

#### Easily eliminates vibration!

The auto-tuning suppresses vibration automatically.

Tuning ON

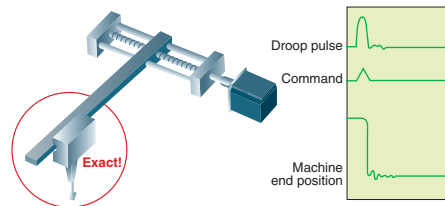

#### ● When drive shaft such as ball screw resonates

##### Adaptive Filter II

\*Patent pending

Easier to use!



The optimum "machine resonance suppression filter" is automatically set to suppress resonance without even measuring the machine system's (drive shaft) frequency characteristics. The adaptive frequency range has been increased compared to the existing models, so resonance at the drive shaft can also be suppressed.

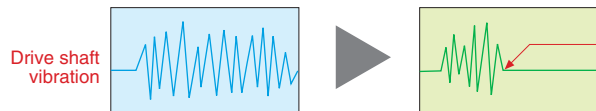

"Adaptive filter II" function ON

#### ● To improve the synchronization accuracy of printing machines and packaging machines, etc.

##### Robust Disturbance Compensation Function



The response only for the disturbance element can be increased, making it possible to suppress the disturbance in a stable state.

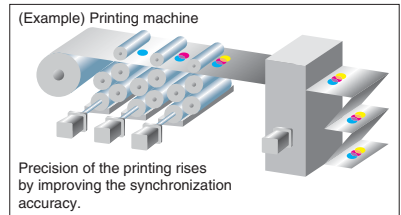
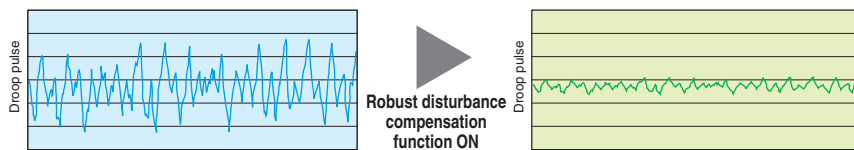

### ■ Simple setup and tuning support tools - Easy-to-use setup software (MR Configurator) -

#### ● Simple setup

The new "Parameter setting" window makes setup even easier!

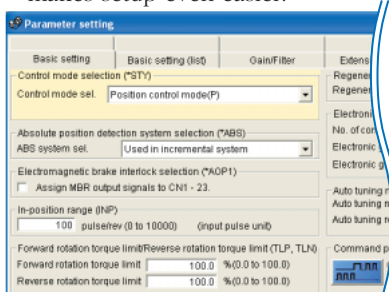

#### ● To find the motor status

##### Monitor function diagnostic function



• USB interface enables the high-speed sampling and long-term waveform measurement.

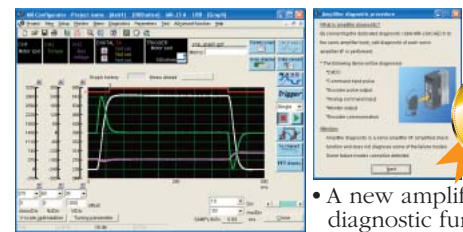

• One analog channel has been added to the graph function (total: 3ch).

• A new amplifier diagnostic function has been added.



#### ● For uniform management of information

For the MR-J3-B type, MR Configurator (setup software) can be used on a personal computer connected to a motion controller (Q172HCPU/Q173HCPU). The uniform management of information such as parameter settings of multi-axes and monitor is easily possible!

# SSCNET III, new high-speed serial bus compatible: MR-J3-B type

## High-speed with high accuracy via optical communication

- Improved system responsiveness!  
The speed of exchanging data between the controller and the servo amplifier has been greatly increased thereby shortening the tact time.
- Synchronized control and synchronized starting for advanced interpolation!
- Smooth control using the high-speed serial communication with cycle time up to 0.44ms! (Note 1)

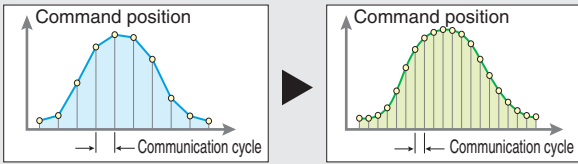

## Easy and flexible wiring with optical communication

- Compatible with long distance wiring (Maximum overall distance: up to 50m between stations (Note 2) x number of axes).
- Reduced wiring by issuing the stroke limit signal and the proximity dog signal via the servo amplifier.
- Simple connection with dedicated cables, reducing wiring time and chances of wiring errors.

## Enhanced reliability

- Improved noise resistance with optical communication!

Notes: 1. The communication cycle varies depending on the number of axes connected and the controller operation cycle.  
2. When using a long distance cable: 50m between stations x 16 axes = 800m

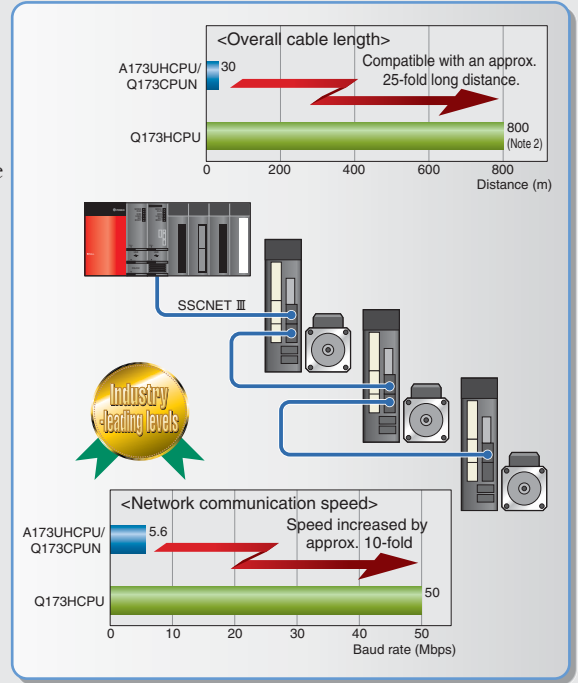

## Contents

Features . . . . .	1	MR-J3-B	
Model Configurations . . . . .	4	Peripheral Equipment (MR-J3-□B) . . . . .	19
Motor Specifications and Characteristics . . . . .	5	Amplifier Specifications . . . . .	20
Motor Dimensions . . . . .	9	Standard Wiring Diagram . . . . .	21
Motor Special Specifications . . . . .	11	Amplifier Dimensions . . . . .	22
MR-J3-A		Options (Note) . . . . .	24
Peripheral Equipment (MR-J3-□A) . . . . .	12	Ordering Information for Customers . . . . .	31
Amplifier Specifications . . . . .	13	MR-J3 Basic Configuration . . . . .	33
Standard Wiring Diagram . . . . .	14	Options . . . . .	35
Amplifier Dimensions . . . . .	17	Using a Personal Computer . . . . .	36
		Peripheral Equipment . . . . .	39
		Cautions Concerning Use . . . . .	42

Note: The cables and connectors in the section "Options ● Cables and connectors" in this catalog are sold separately. Suitable connectors vary for each motor, so carefully look through this catalog before ordering.

# Model Configurations

## ■ For servo amplifier

# MR-J3-10 A

Mitsubishi general-purpose  
AC servo amplifier  
MELSERVO-J3 Series

A : General-purpose interface  
B : SSCNET III compatible

### List of compatible motors

Symbol	HF-MP	HF-KP	HF-SP	
			1000r/min	2000r/min
10	053, 13	053, 13	—	—
20	23	23	—	—
40	43	43	—	—
60	—	—	51	52
70	73	73	—	—
100	—	—	81	102
200	—	—	121, 201	152, 202
350	—	—	—	352
500	—	—	—	502
700	—	—	—	702



Symbol	Power supply
None	3-phase 200VAC or 1-phase 230VAC (Note.1)
1	1-phase 100VAC (Note.2)

Notes: 1. The 1-phase 200VAC is available only for the MR-J3-70□ or smaller servo amplifier.  
2. The 1-phase 100VAC is available only for the MR-J3-40□1 or smaller servo amplifier.

\* Conforms to following standards:  
EN, UL and cUL

## ■ For servo motor

# HF-KP 05 3 B

Symbol	Motor series
HF-MP	Ultra-low inertia, small capacity 
HF-KP	Low inertia, small capacity 
HF-SP	Medium inertia, medium capacity 

Symbol	Oil seal
None	None
J	Installed (Note1, 2)

Notes: 1. Dimensions for the HF-MP/HF-KP series motors with an oil seal are different from those for the standard model. Contact Mitsubishi for details.  
2. For the HF-MP/HF-KP series, the oil seal is available only for 0.1kW or larger.

Symbol	Shaft end
None	Standard (Straight shaft)
K	Key way or with Key (Note)
D	D-cut (Note)

Note: Refer to the section "Special shaft end specifications" in this catalog for the compatible models and detailed specifications.

Symbol	Electromagnetic brake
None	None
B	Installed

Symbol	Rated output (kW)
05	0.05
1 to 8	0.1 to 0.85
10 to 70	1.0 to 7.0

Symbol	Rated speed (r/min)
1	1000 (Note1)
2	2000 (Note1)
3	3000 (Note2)

Notes: 1. 1000r/min and 2000r/min are available only for the HF-SP series.  
2. 3000r/min is available only for the HF-MP/HF-KP series.

\* Conforms to following standards:  
EN, UL and cUL

Note: Contact Mitsubishi for details on whether standards have been acquired for special-order products.

# Motor Specifications and Characteristics



## HF-MP series servo motor specifications

Servo motor series		HF-MP series (Ultra-low inertia, small capacity)						
Specifications	Models	Servo motor model	HF-MP053(B)	HF-MP13(B)	HF-MP23(B)	HF-MP43(B)	HF-MP73(B)	
		Servo amplifier model	MR-J3-10A(1)/B(1)		MR-J3-20A(1)/B(1)	MR-J3-40A(1)/B(1)	MR-J3-70A/B	
Servo motor	Power facility capacity (Note 1) (kVA)		0.3	0.3	0.5	0.9	1.3	
	Continuous running duty	Rated output (W)	50	100	200	400	750	
		Rated torque (N·m [oz·in])	0.16 (22.7)	0.32 (45.3)	0.64 (90.6)	1.3 (184)	2.4 (340)	
	Maximum torque (N·m [oz·in])		0.48 (68.0)	0.95 (135)	1.9 (269)	3.8 (538)	7.2 (1020)	
	Rated speed (r/min)		3000					
	Maximum speed (r/min)		6000					
	Permissible instantaneous speed (r/min)		6900					
	Power rate at continuous rated torque (kW/s)		13.3	31.7	46.1	111.6	95.5	
	Rated current (A)		1.1	0.9	1.6	2.7	5.6	
	Maximum current (A)		3.2	2.8	5.0	8.6	16.7	
	Regenerative braking frequency (times/min) (Note 2)		(Note 2-1)	(Note 2-2)	1570	920	420	
	Moment of inertia J ( $\times 10^{-4}$ kg·m <sup>2</sup> ) [J (oz·in <sup>2</sup> )]		Standard	0.019 (0.104)	0.032 (0.175)	0.088 (0.481)	0.15 (0.820)	0.60 (3.28)
			With electromagnetic brake	0.025 (0.137)	0.039 (0.213)	0.12 (0.656)	0.18 (0.984)	0.70 (3.83)
	Recommended load/motor inertia moment ratio		30 times the servo motor's inertia moment maximum (Note 3)					
	Speed/position detector		18-bit encoder (Resolution per encoder/servo motor rotation: 262144 p/rev)					
	Attachments		—	— (Motors with an oil seal are available (HF-MP□J))				
	Insulation class		Class B					
	Structure		Totally enclosed non ventilated (protection level: IP65) (Note 4)					
Environment	Ambient temperature		0 to 40°C (32 to 104°F) (non freezing), storage: -15 to 70°C (5 to 158°F) (non freezing)					
	Ambient humidity		80% RH maximum (non condensing), storage: 90% RH maximum (non condensing)					
	Atmosphere		Indoors (no direct sunlight); no corrosive gas, inflammable gas, oil mist or dust					
	Elevation/vibration (Note 5)		1000m or less above sea level; X: 49m/s <sup>2</sup> Y: 49m/s <sup>2</sup>					
Mass (kg [lb])	Standard		0.35 (0.78)	0.56 (1.3)	0.94 (2.1)	1.5 (3.3)	2.9 (6.4)	
	With electromagnetic brake		0.65 (1.5)	0.86 (1.9)	1.6 (3.6)	2.1 (4.7)	3.9 (8.6)	

Notes: 1. The power facility capacity varies depending on the power supply's impedance.

2. The regenerative braking frequency shows the permissible frequency for decelerating the motor without a load and the optional regeneration unit from the rated speed to a stop. When a load is connected, however, the value becomes the table value divided by (m+1) where m is the load inertia moment divided by the motor inertia moment. When the operating speed exceeds the rated speed, the regenerative braking frequency is inversely proportional to the square of (Operating speed/rated speed). When the operating speed varies frequently or when regeneration is constant (as with vertical feeds), find the regeneration heat generated (W) while operating. The heat should not exceed the tolerable regenerative power (W). Refer to the section "Options ● Optional regeneration unit" in this catalog for details on the tolerable regenerative power (W).

Optimal regenerative resistor varies for each system. Select the most suitable regenerative resistor by using the capacity selection software.

2-1. When a motor decelerates to a stop from the rated speed, the regenerative frequency will not be limited if the effective torque is within the rated torque range. When a motor decelerates to a stop from the maximum speed, the regenerative frequency will not be limited if the load inertia moment is 26-fold or less and the effective torque is within the rated torque range.

2-2. When a motor decelerates to a stop from the rated speed, the regenerative frequency will not be limited if the effective torque is within the rated torque range. When a motor decelerates to a stop from the maximum speed, the regenerative frequency will not be limited if the load inertia moment is 15-fold or less and the effective torque is within the rated torque range.

3. Contact Mitsubishi if the load/motor of inertia moment ratio exceeds the value in the table.

4. The shaft-through portion is excluded.

5. The vibration direction is shown in the right-side diagram. The numeric value indicates the maximum value of the component (commonly the bracket in the opposite direction of the motor shaft). Fretting of the bearing occurs easily when the motor stops, so maintain vibration to approximately one-half of the allowable value.



## HF-MP series servo motor torque characteristics

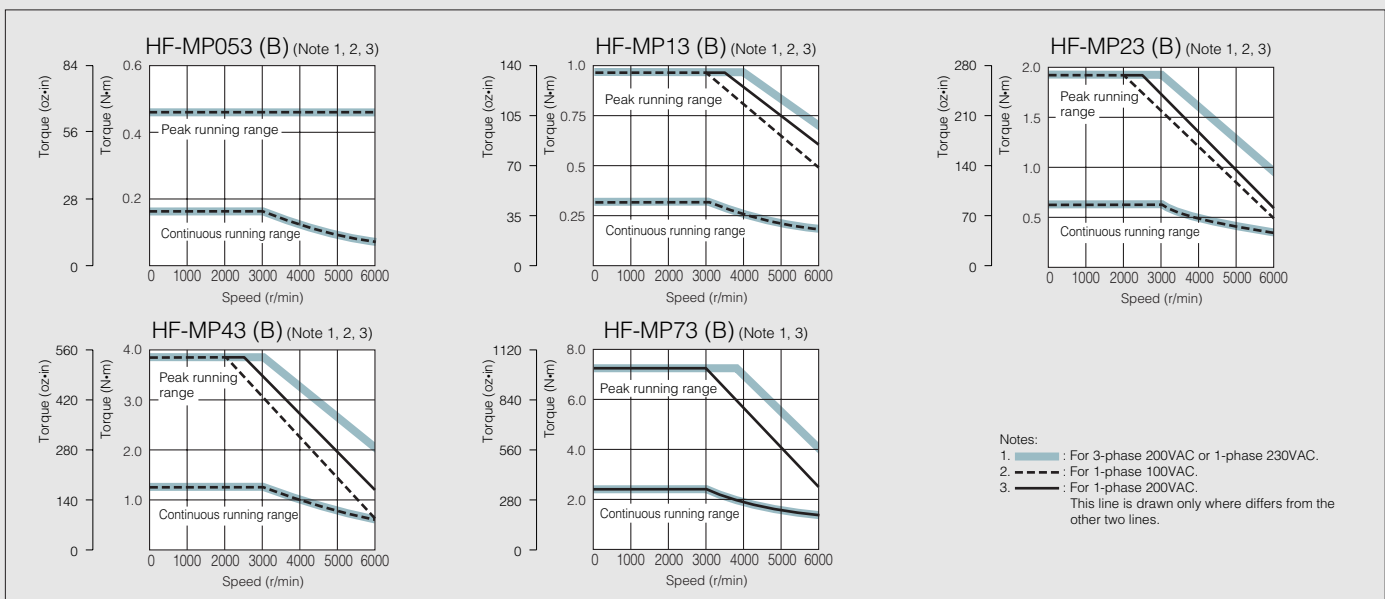

# Motor Specifications and Characteristics



## HF-KP series servo motor specifications

Servo motor series		HF-KP series (Low inertia, small capacity)						
Specifications	Models	Servo motor model	HF-KP053(B)	HF-KP13(B)	HF-KP23(B)	HF-KP43(B)	HF-KP73(B)	
	Servo amplifier model	MR-J3-10A(1)/B(1)		MR-J3-20A(1)/B(1)		MR-J3-40A(1)/B(1)		MR-J3-70A/B
Servo motor	Power facility capacity (Note 1) (kVA)		0.3	0.3	0.5	0.9	1.3	
	Continuous running duty	Rated output (W)	50	100	200	400	750	
		Rated torque (N·m [oz·in])	0.16 (22.7)	0.32 (45.3)	0.64 (90.6)	1.3 (184)	2.4 (340)	
	Maximum torque (N·m [oz·in])		0.48 (68.0)	0.95 (135)	1.9 (269)	3.8 (538)	7.2 (1020)	
	Rated speed (r/min)		3000					
	Maximum speed (r/min)		6000					
	Permissible instantaneous speed (r/min)		6900					
	Power rate at continuous rated torque (kW/s)		4.87	11.5	16.9	38.6	39.9	
	Rated current (A)		0.9	0.8	1.4	2.7	5.2	
	Maximum current (A)		2.7	2.4	4.2	8.1	15.6	
	Regenerative braking frequency (times/min) (Note 2)		(Note 2-1)	(Note 2-2)	448	249	140	
	Moment of inertia J ( $\times 10^{-4}$ kg·m <sup>2</sup> ) [J (oz·in <sup>2</sup> )]		Standard	0.052 (0.284)	0.088 (0.481)	0.24 (1.31)	0.42 (2.30)	1.43 (7.82)
			With electromagnetic brake	0.054 (0.295)	0.090 (0.492)	0.31 (1.69)	0.50 (2.73)	1.63 (8.91)
	Recommended load/motor inertia moment ratio		15 times the servo motor's inertia moment maximum (Note 3)					
	Speed/position detector		18-bit encoder (Resolution per encoder/servo motor rotation: 262144 p/rev)					
	Attachments		—	— (Motors with an oil seal are available (HF-KP□J))				
	Insulation class		Class B					
	Structure		Totally enclosed non ventilated (protection level: IP65) (Note 4)					
Environment	Ambient temperature		0 to 40°C (32 to 104°F) (non freezing), storage: -15 to 70°C (5 to 158°F) (non freezing)					
	Ambient humidity		80% RH maximum (non condensing), storage: 90% RH maximum (non condensing)					
	Atmosphere		Indoors (no direct sunlight); no corrosive gas, inflammable gas, oil mist or dust					
	Elevation/vibration (Note 5)		1000m or less above sea level; X: 49m/s <sup>2</sup> Y: 49m/s <sup>2</sup>					
Mass (kg [lb])	Standard		0.35 (0.78)	0.56 (1.3)	0.94 (2.1)	1.5 (3.3)	2.9 (6.4)	
	With electromagnetic brake		0.65 (1.5)	0.86 (1.9)	1.6 (3.6)	2.1 (4.7)	3.9 (8.6)	

Notes: 1. The power facility capacity varies depending on the power supply's impedance.

2. The regenerative braking frequency shows the permissible frequency for decelerating the motor without a load and the optional regeneration unit from the rated speed to a stop. When a load is connected, however, the value becomes the table value divided by (m+1) where m is the load inertia moment divided by the motor inertia moment. When the operating speed exceeds the rated speed, the regenerative braking frequency is inversely proportional to the square of (Operating speed/rated speed). When the operating speed varies frequently or when regeneration is constant (as with vertical feeds), find the regeneration heat generated (W) while operating. The heat should not exceed the tolerable regenerative power (W). Refer to the section "Options ● Optional regeneration unit" in this catalog for details on the tolerable regenerative power (W).

Optimal regenerative resistor varies for each system. Select the most suitable regenerative resistor by using the capacity selection software.

2-1. When a motor decelerates to a stop from the rated speed, the regenerative frequency will not be limited if the effective torque is within the rated torque range. When a motor decelerates to a stop from the maximum speed, the regenerative frequency will not be limited if the load inertia moment is 8-fold or less and the effective torque is within the rated torque range.

2-2. When a motor decelerates to a stop from the rated speed, the regenerative frequency will not be limited if the effective torque is within the rated torque range. When a motor decelerates to a stop from the maximum speed, the regenerative frequency will not be limited if the load inertia moment is 4-fold or less and the effective torque is within the rated torque range.

3. Contact Mitsubishi if the load/motor of inertia moment ratio exceeds the value in the table.

4. The shaft-through portion is excluded.

5. The vibration direction is shown in the right-side diagram. The numeric value indicates the maximum value of the component (commonly the bracket in the opposite direction of the motor shaft). Fretting of the bearing occurs easily when the motor stops, so maintain vibration to approximately one-half of the allowable value.



## HF-KP series servo motor torque characteristics

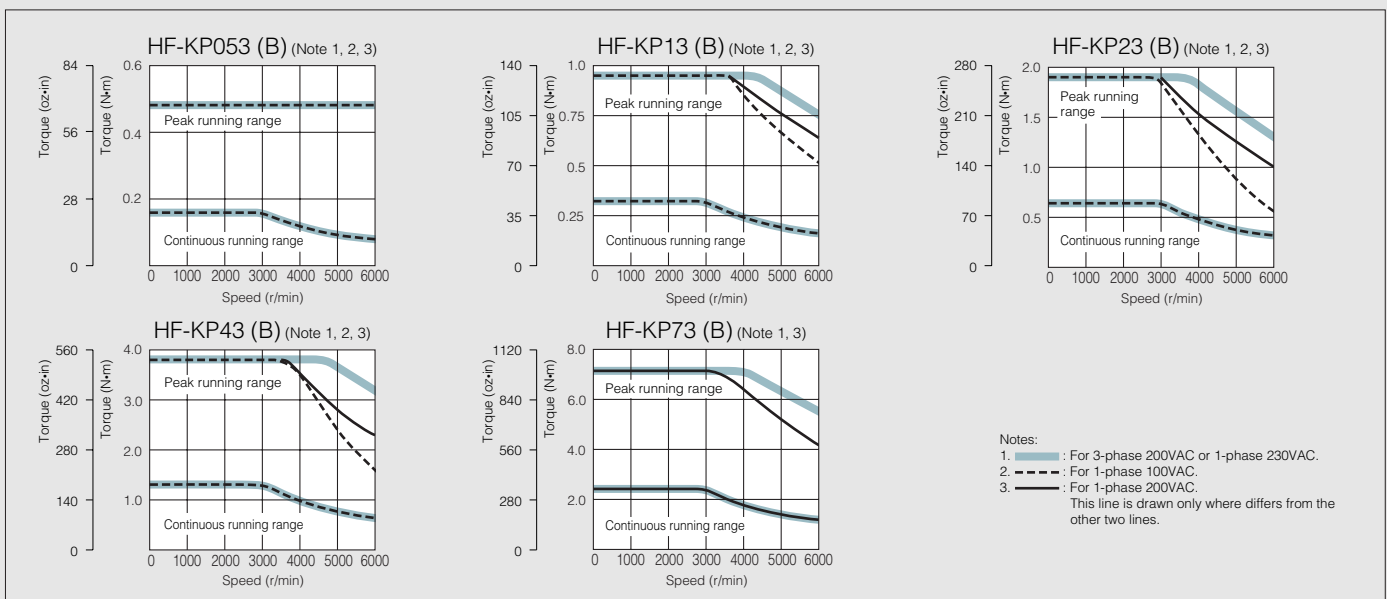

# Motor Specifications and Characteristics



## HF-SP 1000r/min series servo motor specifications

Servo motor series		HF-SP 1000r/min series (Medium inertia, medium capacity)				
Specifications	Models	Servo motor model	HF-SP51(B)	HF-SP81(B)	HF-SP121(B)	HF-SP201(B)
		Servo amplifier model	MR-J3-60A/B	MR-J3-100A/B	MR-J3-200A/B	
Servo motor	Power facility capacity (Note 1) (kVA)		1.0	1.5	2.1	3.5
	Continuous running duty	Rated output (W)	0.5	0.85	1.2	2.0
		Rated torque (N·m [oz·in])	4.77 (675)	8.12 (1150)	11.5 (1630)	19.1 (2700)
	Maximum torque (N·m [oz·in])		14.3 (2020)	24.4 (3460)	34.4 (4870)	57.3 (8110)
	Rated speed (r/min)		1000			
	Maximum speed (r/min)		1500			
	Permissible instantaneous speed (r/min)		1725			
	Power rate at continuous rated torque (kW/s)		19.2	37.0	34.3	48.6
	Rated current (A)		2.9	4.5	6.5	11
	Maximum current (A)		8.7	13.5	19.5	33
	Regenerative braking frequency (times/min) (Note 2)		36	90	188	105
	Moment of inertia J ( $\times 10^{-4}$ kg·m <sup>2</sup> ) [J (oz·in <sup>2</sup> )]	Standard	11.9 (65.1)	17.8 (97.3)	38.3 (209)	75.0 (410)
		With electromagnetic brake	14.0 (76.5)	20.0 (109)	47.9 (262)	84.7 (463)
	Recommended load/motor inertia moment ratio		15 times the servo motor's inertia moment maximum (Note 3)			
	Speed/position detector		18-bit encoder (Resolution per encoder/servo motor rotation: 262144 p/rev)			
	Attachments		— (Motors with an oil seal are available (HF-SP□J))			
	Insulation class		Class F			
	Structure		Totally enclosed non ventilated (protection level: IP67) (Note 4)			
	Environment	Ambient temperature	0 to 40°C (32 to 104°F) (non freezing), storage: -15 to 70°C (5 to 158°F) (non freezing)			
		Ambient humidity	80% RH maximum (non condensing), storage: 90% RH maximum (non condensing)			
Atmosphere		Indoors (no direct sunlight); no corrosive gas, inflammable gas, oil mist or dust				
Elevation		1000m or less above sea level				
Mass (kg [lb])	Vibration (Note 5)	X: 24.5m/s <sup>2</sup> Y: 24.5m/s <sup>2</sup>		X: 24.5m/s <sup>2</sup> Y: 49m/s <sup>2</sup>		
	Standard	6.5 (15)	8.3 (19)	12 (27)	19 (42)	
	With electromagnetic brake	8.5 (19)	10.3 (23)	18 (40)	25 (56)	

Notes: 1. The power facility capacity varies depending on the power supply's impedance.

2. The regenerative braking frequency shows the permissible frequency for decelerating the motor without a load and the optional regeneration unit from the rated speed to a stop. When a load is connected, however, the value becomes the table value divided by  $(m+1)$  where  $m$  is the load inertia moment divided by the motor inertia moment. When the operating speed exceeds the rated speed, the regenerative braking frequency is inversely proportional to the square of (Operating speed/rated speed). When the operating speed varies frequently or when regeneration is constant (as with vertical feeds), find the regeneration heat generated (W) while operating. The heat should not exceed the tolerable regenerative power (W). Refer to the section "Options ● Optional regeneration unit" in this catalog for details on the tolerable regenerative power (W). Optimal regenerative resistor varies for each system. Select the most suitable regenerative resistor by using the capacity selection software.

3. Contact Mitsubishi if the load/motor of inertia moment ratio exceeds the value in the table.

4. The shaft-through portion is excluded.

5. The vibration direction is shown in the right-side diagram. The numeric value indicates the maximum value of the component (commonly the bracket in the opposite direction of the motor shaft). Fretting of the bearing occurs easily when the motor stops, so maintain vibration to approximately one-half of the allowable value.



## HF-SP 1000r/min series servo motor torque characteristics

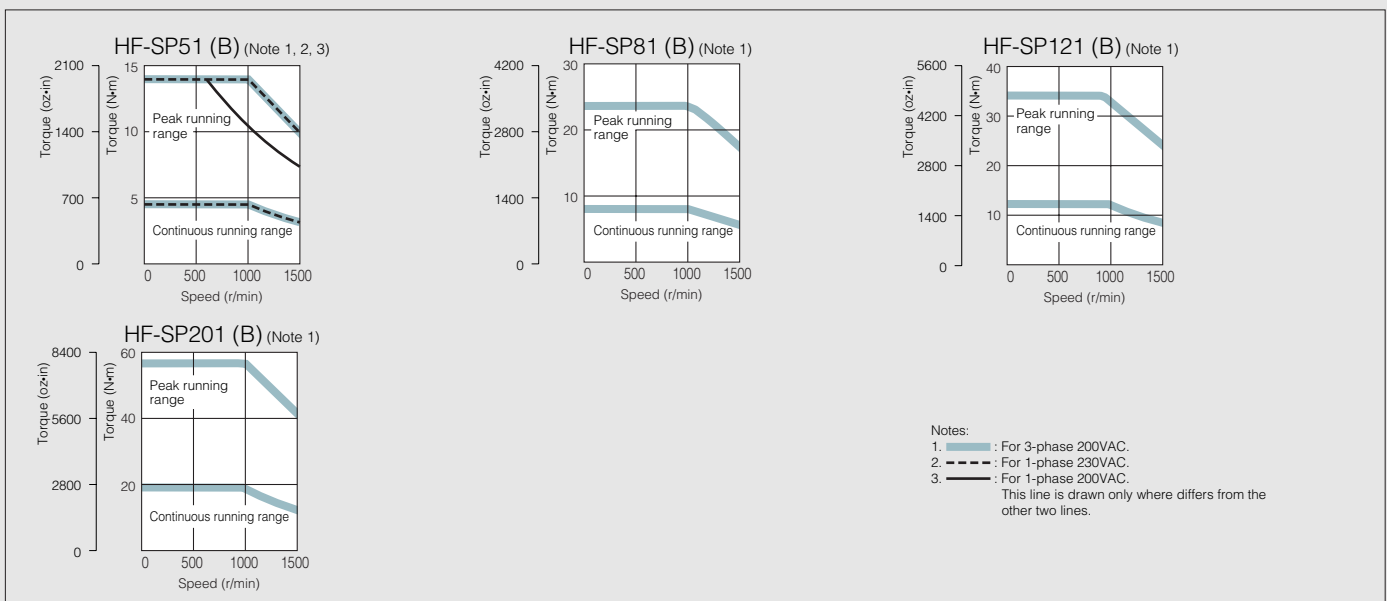



# Motor Specifications and Characteristics



## HF-SP 2000r/min series servo motor specifications

Servo motor series		HF-SP 2000r/min series (Medium inertia, medium capacity)							
Specifications	Models	Servo motor model	HF-SP52(B)	HF-SP102(B)	HF-SP152(B)	HF-SP202(B)	HF-SP352(B)	HF-SP502(B)	HF-SP702(B)
	Servo amplifier model	MR-J3-60A/B	MR-J3-100A/B	MR-J3-200A/B		MR-J3-350A/B	MR-J3-500A/B	MR-J3-700A/B	
Power facility capacity (Note 1) (kVA)		1.0	1.7	2.5	3.5	5.5	7.5	10	
Continuous running duty	Rated output (W)	0.5	1.0	1.5	2.0	3.5	5.0	7.0	
	Rated torque (N·m [oz·in])	2.39 (338)	4.77 (675)	7.16 (1010)	9.55 (1350)	16.7 (2360)	23.9 (3380)	33.4 (4730)	
Maximum torque (N·m [oz·in])		7.16 (1010)	14.3 (2020)	21.5 (3040)	28.6 (4050)	50.1 (7090)	71.6 (10100)	100 (14200)	
Rated speed (r/min)		2000							
Maximum speed (r/min)		3000							
Permissible instantaneous speed (r/min)		3450							
Power rate at continuous rated torque (kW/s)		9.34	19.2	28.8	23.8	37.2	58.8	72.5	
Rated current (A)		2.9	5.3	8.0	10	16	24	33	
Maximum current (A)		8.7	15.9	24	30	48	72	99	
Regenerative braking frequency (times/min) (Note 2)		60	62	152	71	33	37	31	
Moment of inertia J ( $\times 10^{-4}$ kg·m <sup>2</sup> ) [J (oz·in <sup>2</sup> )]	Standard	6.1 (33.4)	11.9 (65.1)	17.8 (97.3)	38.3 (209)	75.0 (410)	97.0 (530)	154 (842)	
	With electromagnetic brake	8.3 (45.4)	14.0 (76.5)	20.0 (109)	47.9 (262)	84.7 (463)	107 (585)	164 (897)	
Recommended load/motor inertia moment ratio		15 times the servo motor's inertia moment maximum (Note 3)							
Speed/position detector		18-bit encoder (Resolution per encoder/servo motor rotation: 262144 p/rev)							
Attachments		— (Motors with an oil seal are available (HF-SP□J))							
Insulation class		Class F							
Structure		Totally enclosed non ventilated (protection level: IP67) (Note 4)							
Environment	Ambient temperature	0 to 40°C (32 to 104°F) (non freezing), storage: -15 to 70°C (5 to 158°F) (non freezing)							
	Ambient humidity	80% RH maximum (non condensing), storage: 90% RH maximum (non condensing)							
	Atmosphere	Indoors (no direct sunlight); no corrosive gas, inflammable gas, oil mist or dust							
	Elevation	1000m or less above sea level							
Vibration (Note 5)		X: 24.5m/s <sup>2</sup> Y: 24.5m/s <sup>2</sup>			X: 24.5m/s <sup>2</sup> Y: 49m/s <sup>2</sup>		X: 24.5m/s <sup>2</sup> Y: 29.4m/s <sup>2</sup>		
Mass (kg [lb])	Standard	4.8 (11)	6.5 (15)	8.3 (19)	12 (27)	19 (42)	22 (49)	32 (71)	
	With electromagnetic brake	6.7 (15)	8.5 (19)	10.3 (23)	18 (40)	25 (56)	28 (62)	38 (84)	

Notes: 1. The power facility capacity varies depending on the power supply's impedance.

2. The regenerative braking frequency shows the permissible frequency for decelerating the motor without a load and the optional regeneration unit from the rated speed to a stop. When a load is connected, however, the value becomes the table value divided by (m+1) where m is the load inertia moment divided by the motor inertia moment. When the operating speed exceeds the rated speed, the regenerative braking frequency is inversely proportional to the square of (Operating speed/rated speed). When the operating speed varies frequently or when regeneration is constant (as with vertical feeds), find the regeneration heat generated (W) while operating. The heat should not exceed the tolerable regenerative power (W). Refer to the section "Options ● Optional regeneration unit" in this catalog for details on the tolerable regenerative power (W). Optimal regenerative resistor varies for each system. Select the most suitable regenerative resistor by using the capacity selection software.

3. Contact Mitsubishi if the load/motor of inertia moment ratio exceeds the value in the table.

4. The shaft-through portion is excluded.

5. The vibration direction is shown in the right-side diagram. The numeric value indicates the maximum value of the component (commonly the bracket in the opposite direction of the motor shaft). Fretting of the bearing occurs easily when the motor stops, so maintain vibration to approximately one-half of the allowable value.



## HF-SP 2000r/min series servo motor torque characteristics

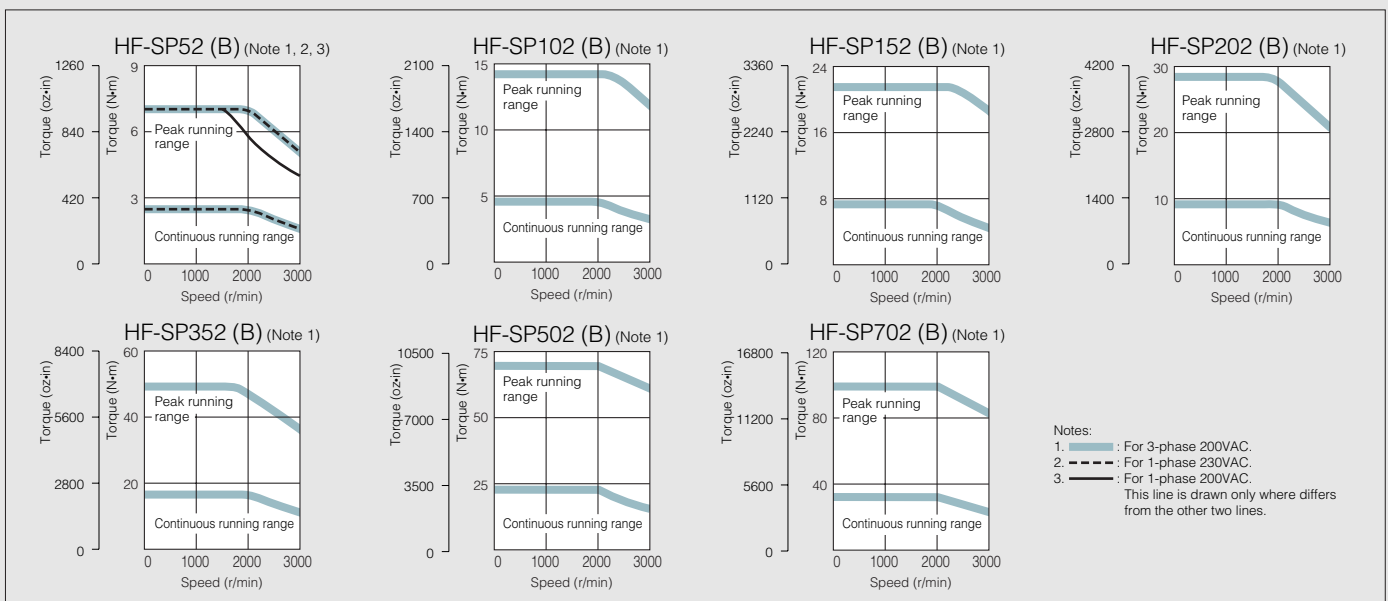



# Motor Dimensions

(Unit: mm)

- HF-SP51(B), HF-SP81(B)
- HF-SP52(B) to HF-SP152(B)

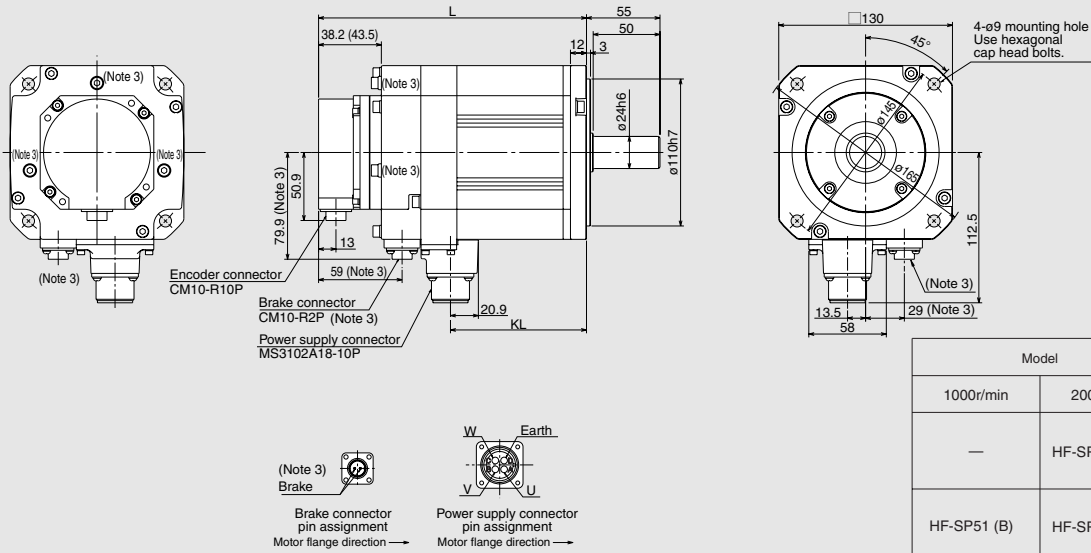

Model		Variable dimensions	
1000r/min	2000r/min	L	KL
—	HF-SP52 (B)	118.5 (153)	57.8
HF-SP51 (B)	HF-SP102 (B)	140.5 (175)	79.8
HF-SP81 (B)	HF-SP152 (B)	162.5 (197)	101.8

- HF-SP121(B), HF-SP201(B)
- HF-SP202(B) to HF-SP702(B)

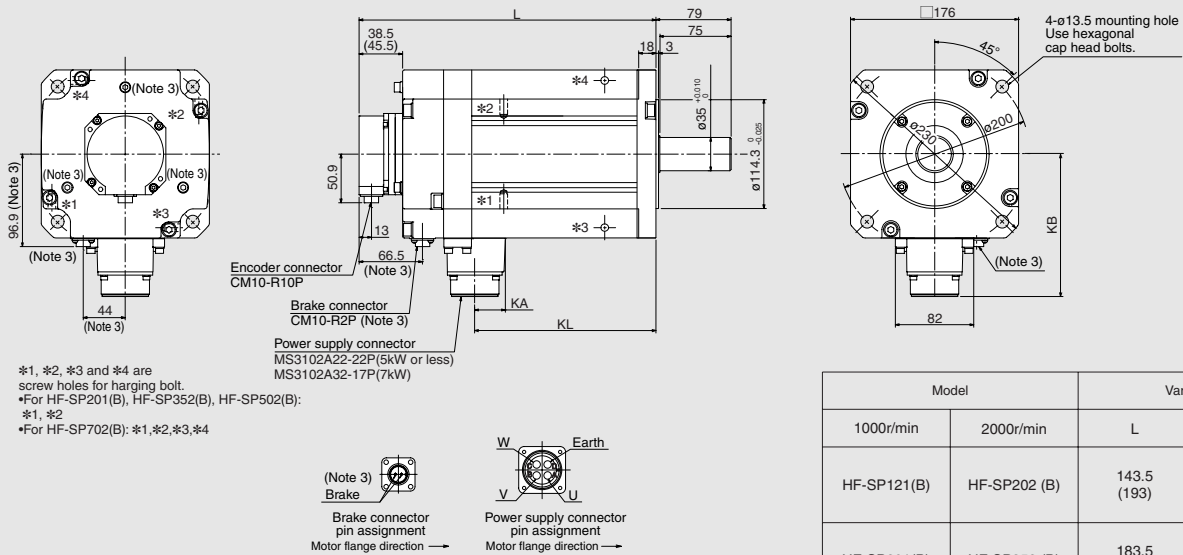

- \*1, \*2, \*3 and \*4 are screw holes for hanging bolt.  
 \*For HF-SP201(B), HF-SP352(B), HF-SP502(B):  
 \*1, \*2  
 \*For HF-SP702(B): \*1, \*2, \*3, \*4

Model		Variable dimensions			
1000r/min	2000r/min	L	KL	KA	KB
HF-SP121(B)	HF-SP202 (B)	143.5 (193)	79.8		
HF-SP201(B)	HF-SP352 (B)	183.5 (233)	119.8	24.8	140.9
—	HF-SP502 (B)	203.5 (253)	139.8		
—	HF-SP702 (B)	263.5 (313)	191.8	32	149.1

Notes:

1. Use a friction coupling to fasten a load.
2. Dimensions inside ( ) are for the models with an electromagnetic brake.
3. Only for the models with an electromagnetic brake. The electromagnetic brake terminals do not have the polarity.
4. For dimensions where there is no tolerance listed, use general tolerance.

# Motor Special Specifications

## Special shaft end specifications

Motors with the following specifications are available.

### HF-MP/HF-KP series

#### ● D-cut (Note 1) (50, 100W)

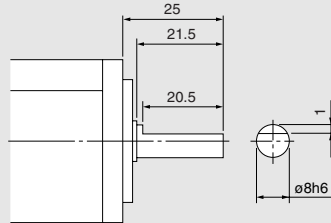

(Unit: mm)

#### ● With key (200, 400, 750W)

Motor model	Capacity (W)	Variable dimensions								Y
		T	S	R	Q	W	QK	QL	U	
HF-MP□K HF-KP□K	200, 400	5	14h6	30	27	5	20	3	3	M4 screw Depth: 15mm
	750	6	19h6	40	37	6	25	5	3.5	M5 screw Depth: 20mm

(Note 1)

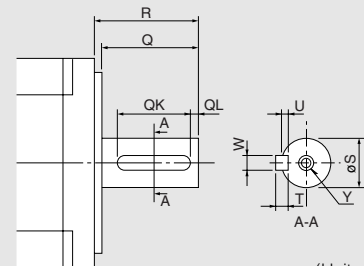

(Unit: mm)

### HF-SP 2000r/min series

#### ● Key way

Motor model	Capacity (kW)	Variable dimensions								Y
		S	R	Q	W	QK	QL	U	r	
HF-SP□K	0.5 to 1.5	24h6	55	50	8 <sup>0</sup> <sub>-0.036</sub>	36	5	4 <sup>+0.2</sup> <sub>0</sub>	4	M8 screw Depth: 20mm
	2.0 to 7.0	35 <sup>+0.01</sup> <sub>0</sub>	79	75	10 <sup>0</sup> <sub>-0.036</sub>	55	5	5 <sup>+0.2</sup> <sub>0</sub>	5	M8 screw Depth: 20mm

(Note 1, 2)

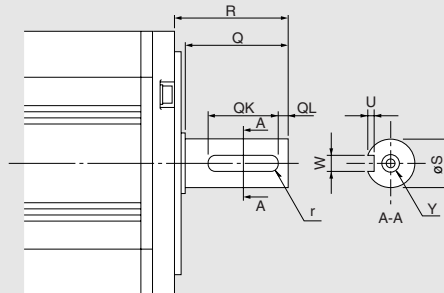

(Unit: mm)

Notes:

1. Cannot be used in applications that involve high frequency. Loose keys may damage the motor shaft.
2. A key is not supplied with the motor. The key shall be installed by the user.

## Electromagnetic brake specifications

Motor model	HF-MP/HF-KP					HF-SP 1000r/min			
	053B	13B	23B	43B	73B	51B	81B	121B	201B
Type	Spring-action safety brake					Spring-action safety brake			
Rated voltage	24VDC <sup>0</sup> <sub>-10%</sub>					24VDC <sup>0</sup> <sub>-10%</sub>			
Brake static friction torque	(N-m)	0.32	1.3	1.3	2.4	8.5	8.5	44	44
	(oz.in)	45.3	184	184	340	1200	1200	6230	6230
Power consumption (W) at 20°C (68°F)	6.3	6.3	7.9	7.9	10	20	20	34	34
Permissible braking work	(J)/time	5.6	22	22	64	400	400	4500	4500
	(J)/hour	56	220	220	640	4000	4000	45000	45000
Brake life (Note 1) (Braking work per braking action)	Times	20000 (5.6J)	20000 (5.6J)	20000 (22J)	20000 (22J)	20000 (64J)	20000 (200J)	20000 (1000J)	20000 (1000J)

Motor model	HF-SP 2000r/min					
	52B	102B	152B	202B	352B	702B
Type	Spring-action safety brake					
Rated voltage	24VDC <sup>0</sup> <sub>-10%</sub>					
Brake static friction torque	(N-m)	8.5	8.5	8.5	44	44
	(oz.in)	1200	1200	1200	6230	6230
Power consumption (W) at 20°C (68°F)	20	20	20	34	34	34
Permissible braking work	(J)/time	400	400	400	4500	4500
	(J)/hour	4000	4000	4000	45000	45000
Brake life (Note 1) (Braking work per braking action)	Times	20000 (200J)	20000 (200J)	20000 (200J)	20000 (1000J)	20000 (1000J)

Notes:

1. The brake gap cannot be adjusted. The brake life shows time until the readjustment is needed.
2. The electromagnetic brake is for holding. It cannot be used for braking applications.

# Peripheral Equipment (MR-J3-□A)

## Connections with peripheral equipment

Peripheral equipment is connected to MR-J3-A as described below.

Connectors, options, and other necessary equipment are available so that users can set up MR-J3-A easily and begin using it right away.

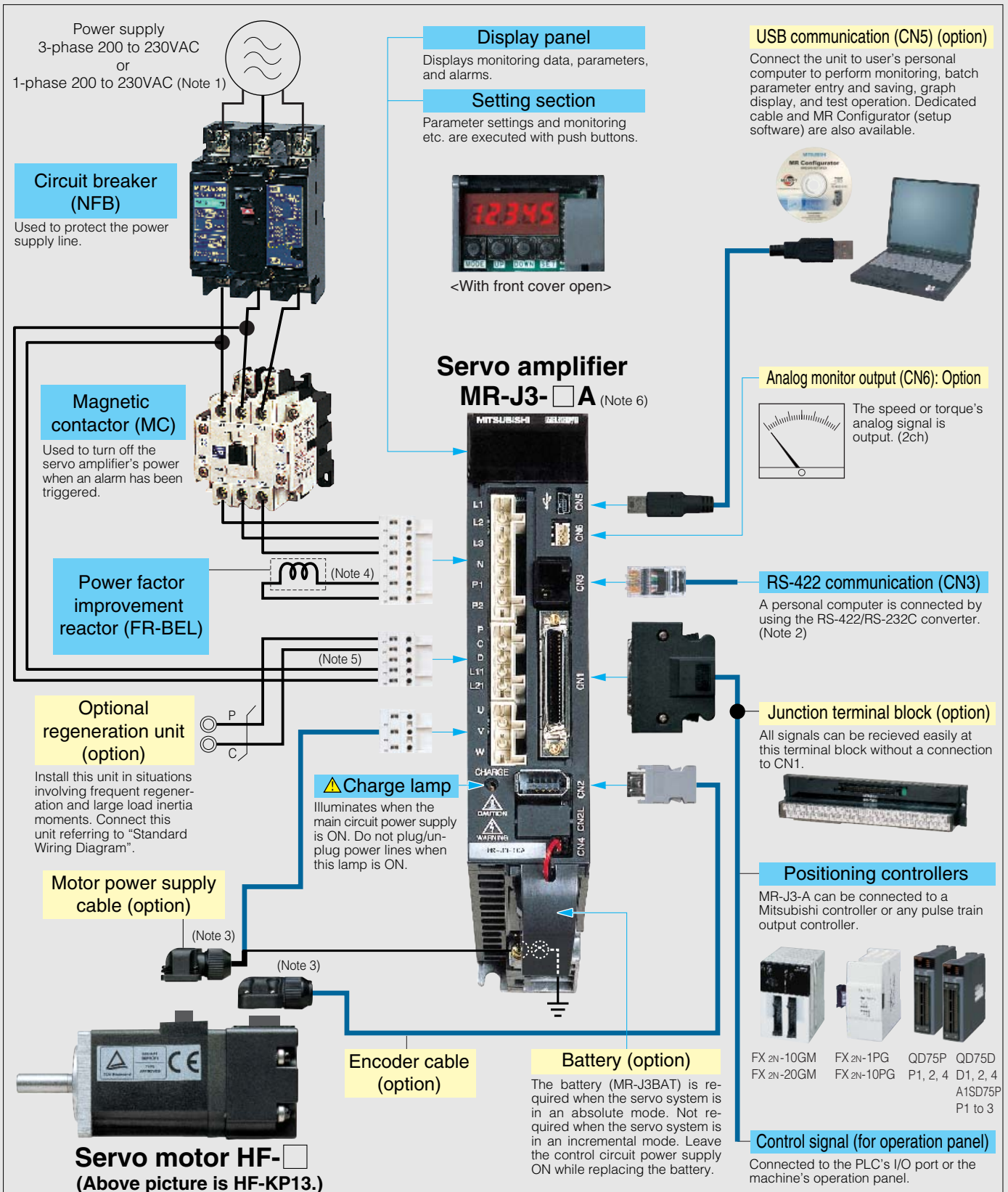

- Notes: 1. When using a power supply, 1-phase 200 to 230VAC, connect the power supply to the L1 and L2 terminals. Do not connect anything to L3.
2. When a personal computer is connected with the RS-422/RS-232C conversion cable (refer to the section "Ordering Information for Customers" in this catalog), some functions of MR Configurator (setup software) may be limited.
3. The connections show that the cables are led out in the opposite direction of the motor shaft. Optional cables are also available for leading the cables out in the direction of the motor shaft. Refer to the section "Options ● Cables and connectors (MR-J3-A type)" in this catalog.
4. Disconnect P1 and P2 when using FR-BEL.
5. Disconnect P and D when connecting the optional regeneration unit externally.
6. The connections with peripheral equipment shown above is for the MR-J3-350A or smaller servo amplifier.  
For MR-J3-500A or larger, connect with peripheral equipment in accordance with the standard wiring diagram in this catalog.

# Amplifier Specifications



## MR-J3-A type

Servo amplifier model MR-J3-			10A	20A	40A	60A	70A	100A	200A	350A	500A	700A	10A1	20A1	40A1		
Servo amplifier	Main circuit power supply	Voltage/frequency (Note 1)	3-phase 200 to 230VAC 50/60Hz or 1-phase 200 to 230VAC 50/60Hz (Note 2) 1-phase 200 to 240VAC 50/60Hz (Note 8)					3-phase 200 to 230VAC 50/60Hz (Note 2)					1-phase 100 to 120VAC 50/60Hz (Note 2)				
		Permissible voltage fluctuation	For 3-phase 200 to 230VAC: 3-phase 170 to 253VAC For 1-phase 200 to 230VAC: 1-phase 170 to 253VAC					3-phase 170 to 253VAC					1-phase 85 to 132VAC				
		Permissible frequency fluctuation	±5% maximum														
	Control circuit power supply	Voltage/frequency	1-phase 200 to 230VAC 50/60Hz											1-phase 100 to 120VAC 50/60Hz			
		Permissible voltage fluctuation	1-phase 170 to 253VAC											1-phase 85 to 132VAC			
		Permissible frequency fluctuation	±5% maximum														
	Power consumption (W)		30					45					30				
	Interface power supply			24VDC ±10% (required current capacity: 300mA (Note 7))													
	Regenerative resistor/ tolerable regenerative power (W) (Note 3)	With no option (Amplifier built-in resistor)		—	10	10	10	20	20	100	100	130	170	—	10	10	
		Optional regeneration unit	MR-RB032	30	30	30	30	30	30	×	×	×	×	30	30	30	
			MR-RB12	×	100	100	100	100	100	×	×	×	×	×	100	100	
			MR-RB30	×	×	×	×	×	×	300	300	×	×	×	×	×	
			MR-RB31	×	×	×	×	×	×	×	×	300	300	×	×	×	
			MR-RB32	×	×	×	×	300	300	×	×	×	×	×	×	×	
			MR-RB50 (Note 4)	×	×	×	×	×	×	500	500	×	×	×	×	×	
MR-RB51 (Note 4)	×	×	×	×	×	×	×	×	500	500	×	×	×				
Control system			Sine-wave PWM control/current control system														
Dynamic brake			Built-in (Note 5)														
Safety features			Overcurrent shutdown, regeneration overvoltage shutdown, overload shutdown (electronic thermal), servo motor overheat protection, encoder fault protection, regeneration fault protection, undervoltage/sudden power outage protection, overspeed protection, excess error protection														
Position control mode	Maximum input pulse frequency		1Mpps (when using differential receiver), 200kpps (when using open collector)														
	Positioning feedback pulse		Resolution per encoder/servo motor rotation: 262144 p/rev														
	Command pulse multiple		Electronic gear A/B multiple, A: 1 to 1048576, B: 1 to 1048576 1/10 < A/B < 2000														
	Positioning complete width setting		0 to ±10000 pulses (command pulse unit)														
	Excess error		±3 rotations														
Torque limit			Set by parameters or external analog input (0 to +10VDC/maximum torque)														
Speed control mode	Speed control range		Analog speed command 1:2000, internal speed command 1:5000														
	Analog speed command input		0 to ±10VDC/rated speed (possible to change the speed in 10V using the parameter No. PC12.)														
	Speed fluctuation rate		±0.01% maximum (load fluctuation 0 to 100%) 0% (power fluctuation ±10%) ±0.2% maximum (ambient temperature 25°C±10°C (77°F±50°F)), when using analog speed command														
	Torque limit			Set by parameters or external analog input (0 to +10VDC/maximum torque)													
Torque control mode	Analog torque command input		0 to ±8VDC/maximum torque (input impedance 10 to 12kΩ)														
	Speed limit			Set by parameters or external analog input (0 to ±10VDC/rated speed)													
Structure			Self-cooling open (IP00)					Fan cooling open (IP00)					Self-cooling open (IP00)				
Environment	Ambient temperature (Note 6)		0 to 55°C (32 to 131°F) (non freezing), storage: -20 to 65°C (-4 to 149°F) (non freezing)														
	Ambient humidity		90% RH maximum (non condensing), storage: 90% RH maximum (non condensing)														
	Atmosphere		Indoors (no direct sunlight); no corrosive gas, inflammable gas, oil mist or dust														
	Elevation		1000m or less above sea level														
	Vibration			5.9m/s <sup>2</sup> maximum													
Mass (kg [lb])			0.8 (1.8)	0.8 (1.8)	1.0 (2.2)	1.0 (2.2)	1.4 (3.1)	1.4 (3.1)	2.3 (5.1)	2.3 (5.1)	4.6 (10)	6.2 (14)	0.8 (1.8)	0.8 (1.8)	1.0 (2.2)		

- Notes: 1. Rated output and rated speed of the servo motor used in combination with the servo amplifier are as indicated when using the power supply voltage and frequency listed. The torque drops when the power supply voltage is less than specified.
2. For torque characteristics when combined with a servo motor, refer to the section "Servo motor torque characteristics" in this catalog.
3. Optimal regenerative resistor varies for each system. Select the most suitable regenerative resistor by using the capacity selection software. Note that the servo amplifiers MR-J3-500A, MR-J3-700A and MR-J3-□A1 are planned to be compatible with the software version A3 or above.
4. Install the cooling fan (1.0m<sup>3</sup>/min, approx. □92).
5. Special specification models without a dynamic brake, MR-J3-□A-ED and MR-J3-□A1-ED, are also available.
6. The MR-J3-350A or smaller servo amplifier can be installed closely. In this case, keep the ambient temperature within 0 to 45°C (32 to 113°F), or use them with 75% or less of the effective load rate.
7. 300mA is the value when all of the input/output points are used. The current capacity can be stepped down according to the number of input/output points in use. Refer to "MR-J3-□A SERVO AMPLIFIER INSTRUCTION MANUAL" for details.
8. The special specification model, MR-J3-□A-U004, is also available for 1-phase 200 to 240 VAC.

# Standard Wiring Diagram

## MR-J3-□A(1) type: Position control operation

### ● Connection to QD75D (position servo, incremental)

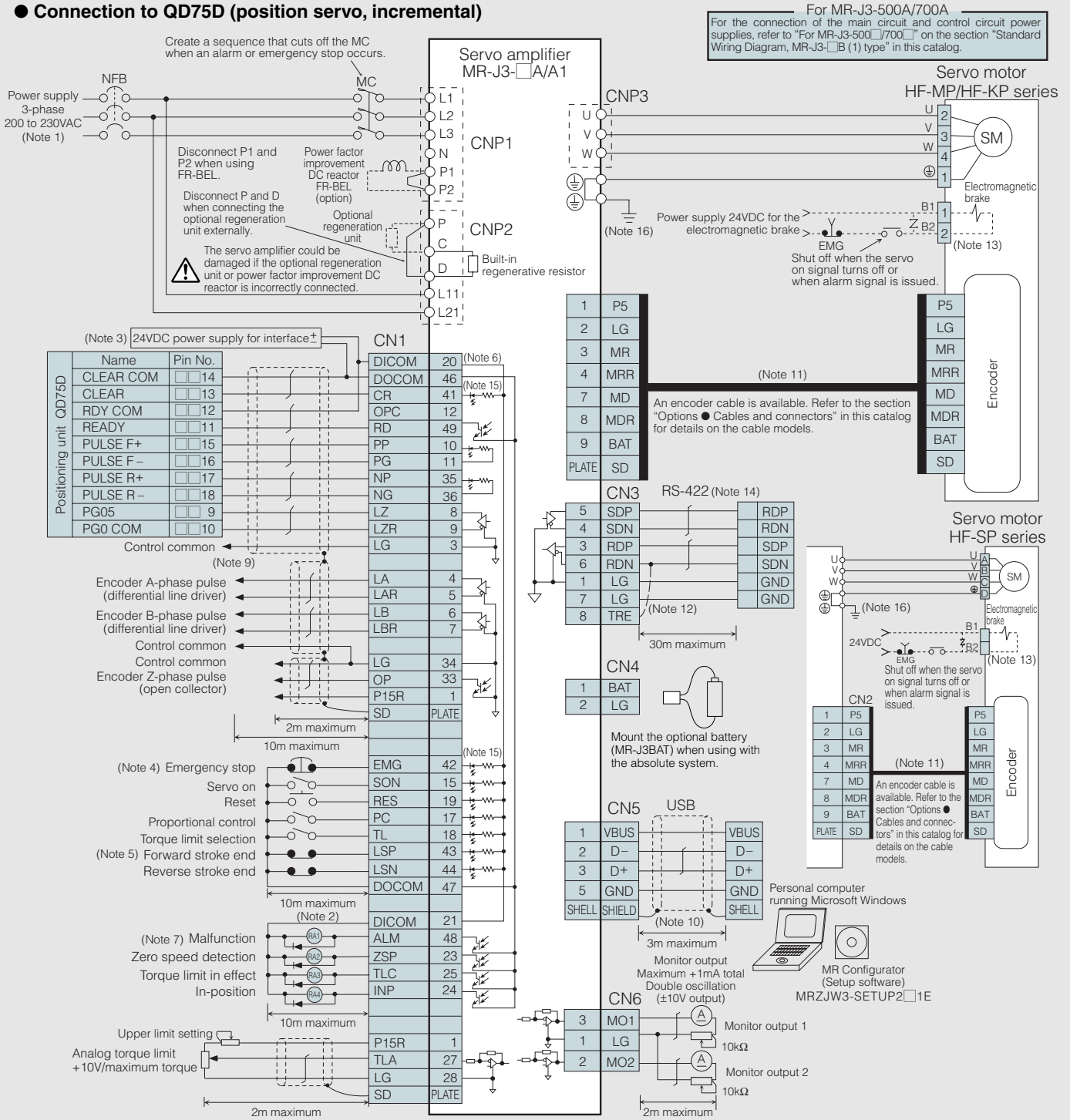

# Standard Wiring Diagram

## MR-J3-□A(1) type: Speed control operation

### ● Connection

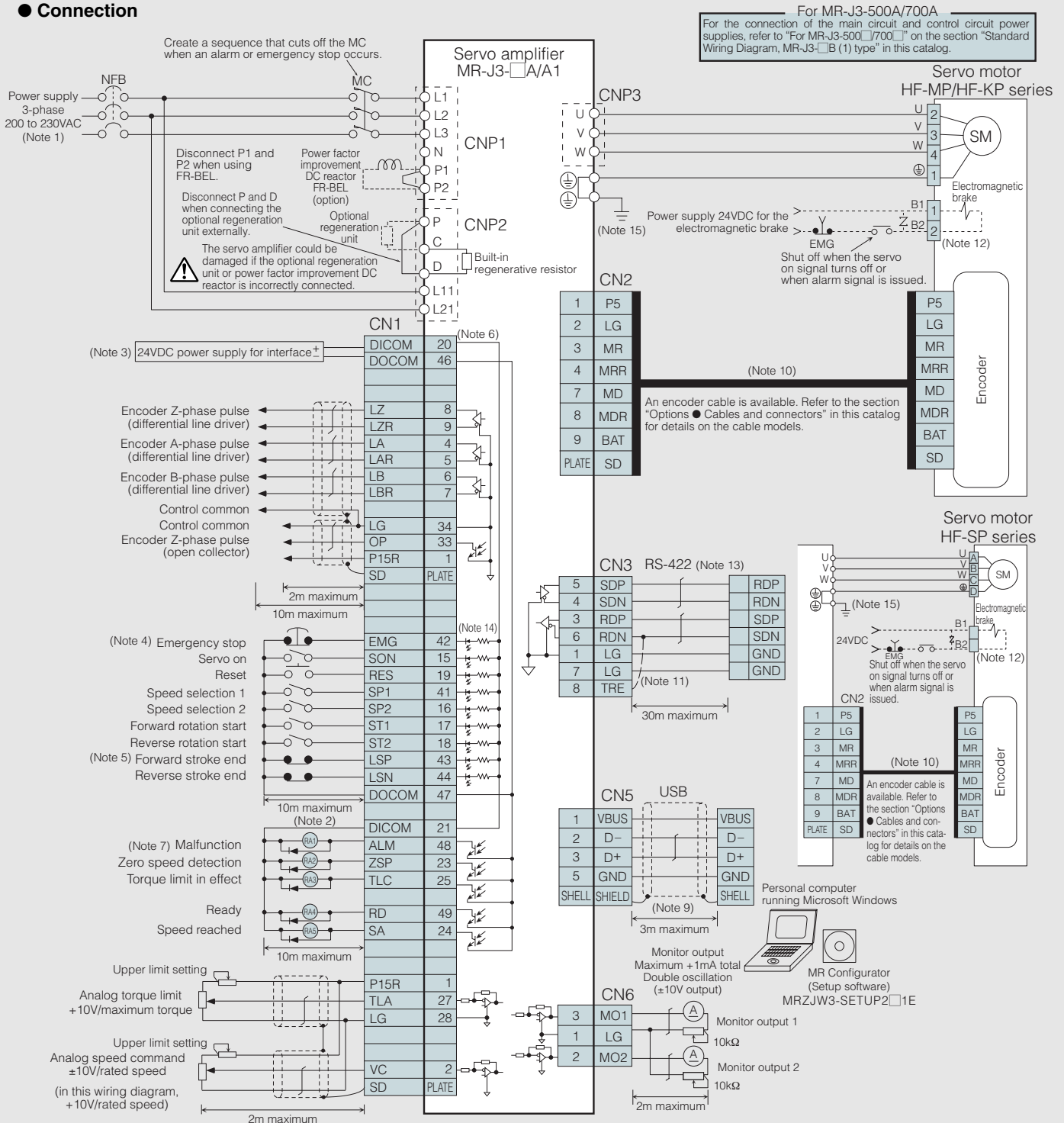



# Standard Wiring Diagram

## MR-J3-□A(1) type: Torque control operation

### ● Connection

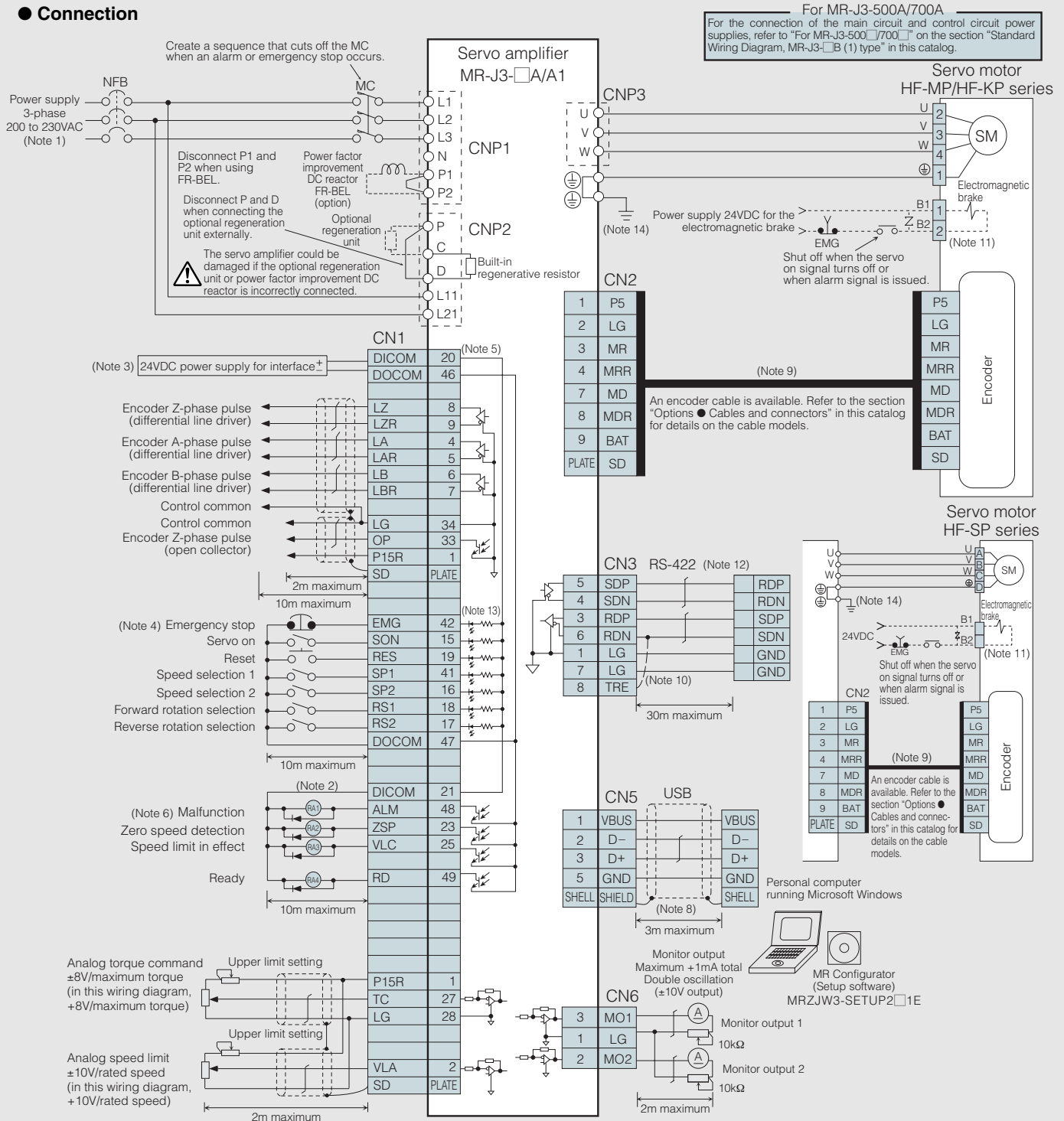

# Amplifier Dimensions

## MR-J3-□A(1) type

(Unit: mm)

### ● MR-J3-10A, 20A, 10A1, 20A1 (Note 1)

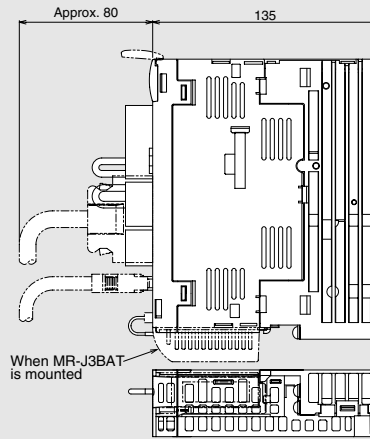
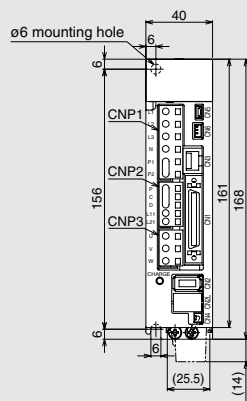

< Terminal arrangement >

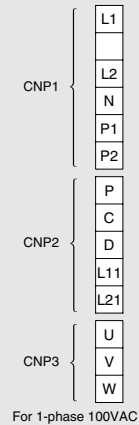

For 1-phase 100VAC

< Terminal arrangement >

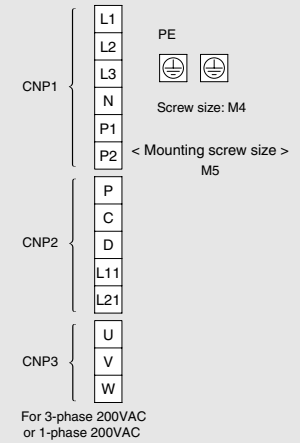

For 3-phase 200VAC or 1-phase 200VAC

### ● MR-J3-40A, 60A, 40A1 (Note 1)

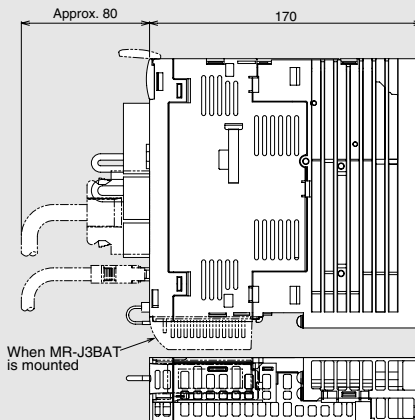
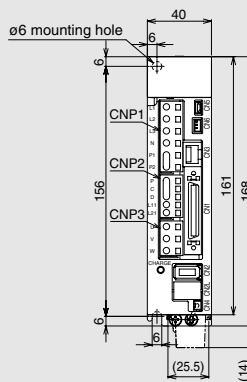

< Terminal arrangement >

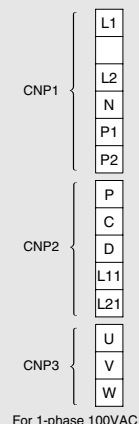

For 1-phase 100VAC

< Terminal arrangement >

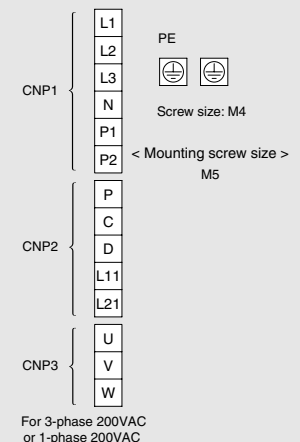

For 3-phase 200VAC or 1-phase 200VAC

### ● MR-J3-70A, 100A (Note 1)

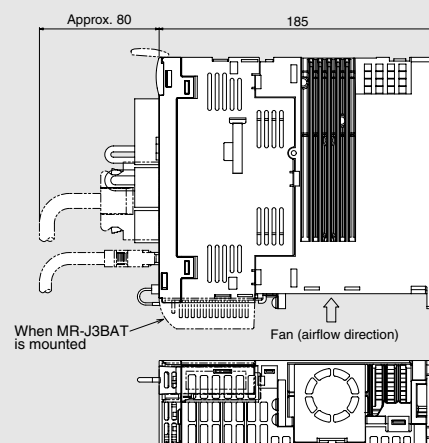
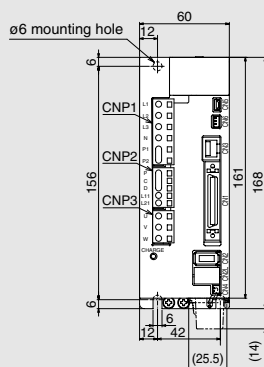

< Terminal arrangement >

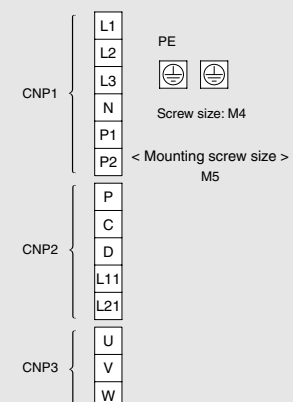

# Amplifier Dimensions

(Unit: mm)

## ● MR-J3-200A, 350A (Note 1)

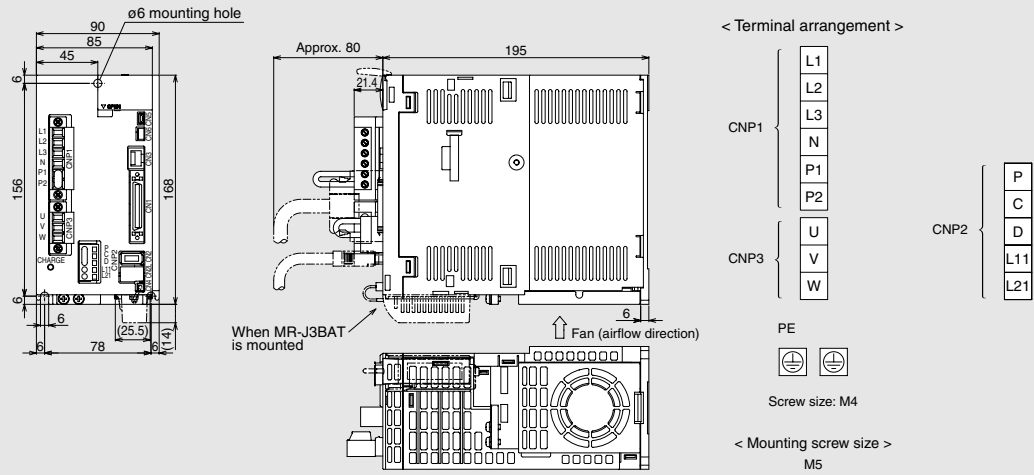

## ● MR-J3-500A

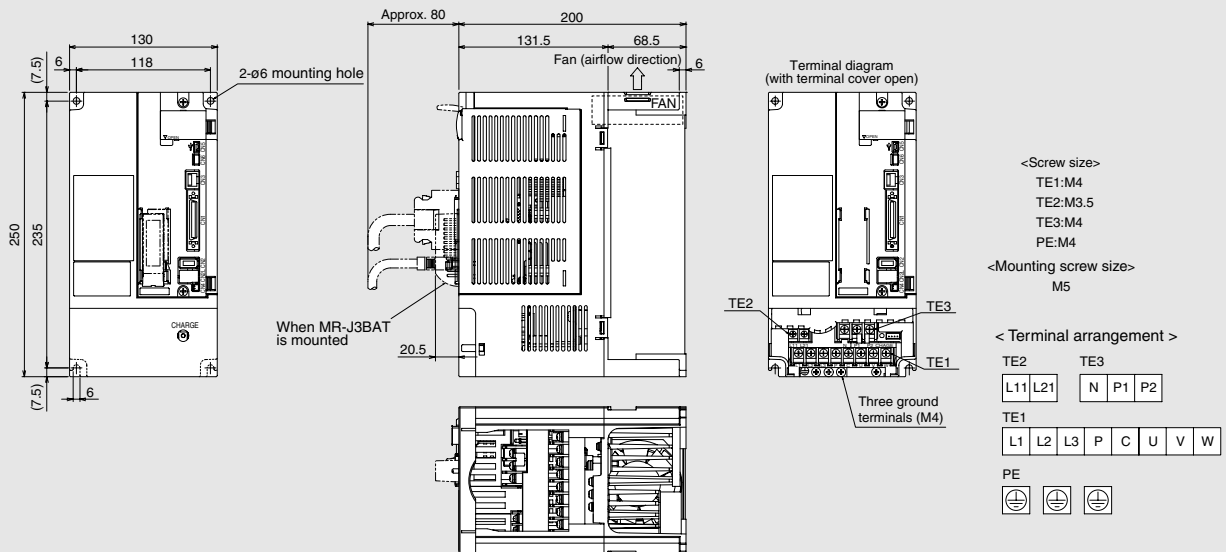

## ● MR-J3-700A

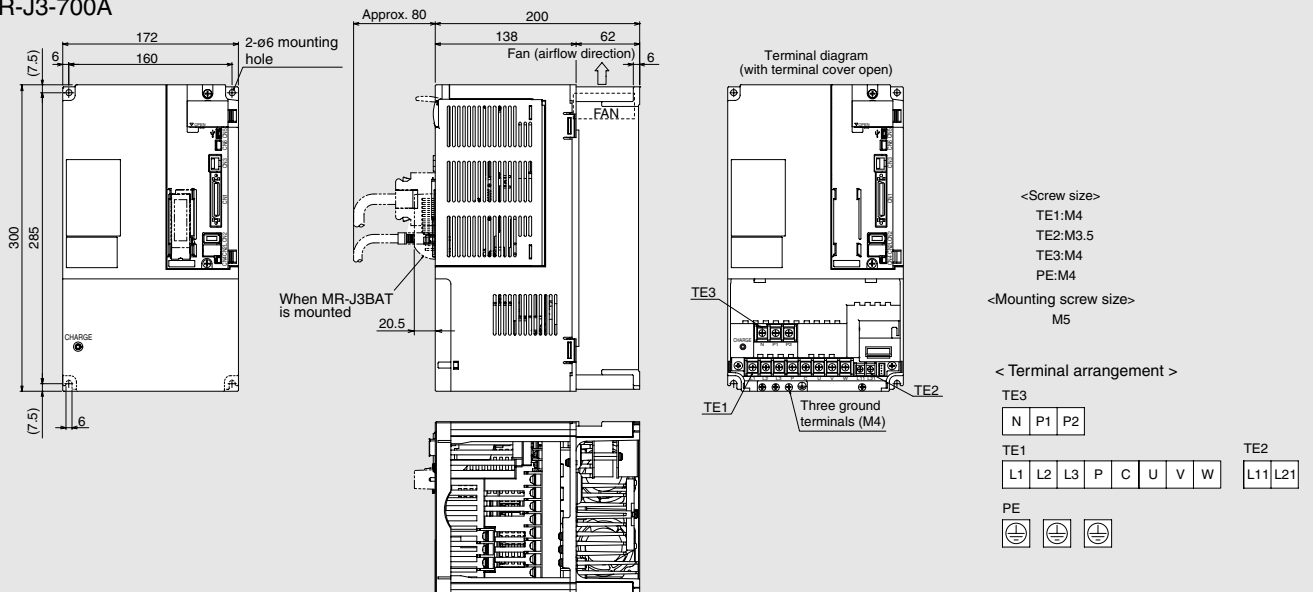

Note: The connectors CNP1, CNP2 and CNP3 (insertion type) are supplied with the servo amplifier.

# Peripheral Equipment (MR-J3-□B)

## Connections with peripheral equipment

Peripheral equipment is connected to MR-J3-B as described below.

Connectors, cables, options, and other necessary equipment are available so that users can set up MR-J3-B easily and begin using it right away. Through its SSCNET III-compatible simple connections, the MR-J3-B series reduce wiring time and chances of wiring errors.

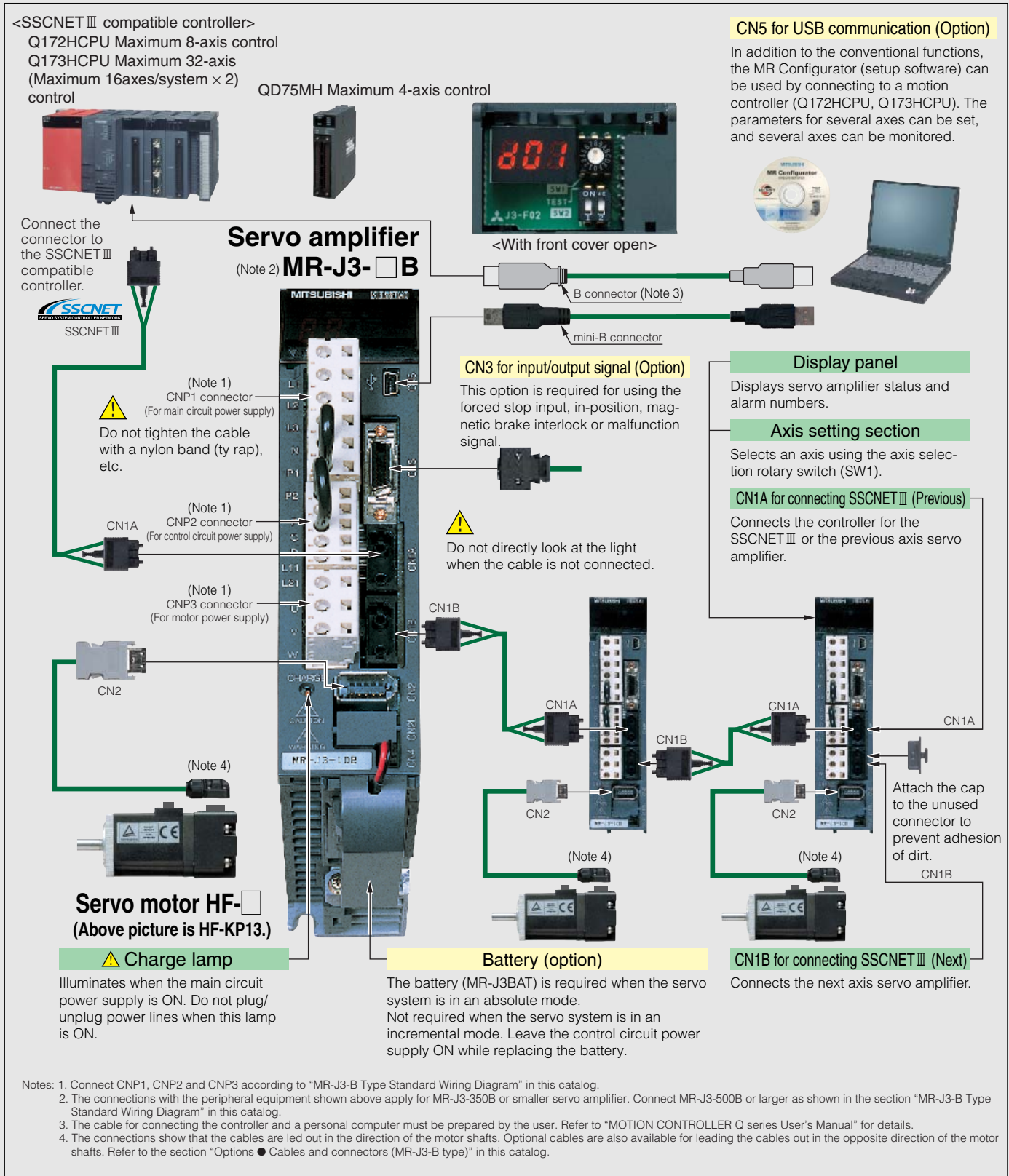

# Amplifier Specifications



## MR-J3-B (SSCNET III compatible) type

Servo amplifier model MR-J3-		10B	20B	40B	60B	70B	100B	200B	350B	500B	700B	10B1	20B1	40B1		
Servo amplifier	Main circuit power supply	Voltage/frequency (Note 1)	3-phase 200 to 230VAC 50/60Hz or 1-phase 200 to 230VAC 50/60Hz (Note 2) 1-phase 200 to 240VAC 50/60Hz (Note 8)					3-phase 200 to 230VAC 50/60Hz (Note 2)					1-phase 100 to 120VAC 50/60Hz (Note 2)			
		Permissible voltage fluctuation	For 3-phase 200 to 230VAC: 3-phase 170 to 253VAC For 1-phase 200 to 230VAC: 1-phase 170 to 253VAC					3-phase 170 to 253VAC					1-phase 85 to 132VAC			
		Permissible frequency fluctuation	±5% maximum													
	Control circuit power supply	Voltage/frequency	1-phase 200 to 230VAC 50/60Hz										1-phase 100 to 120VAC 50/60Hz			
		Permissible voltage fluctuation	1-phase 170 to 253VAC										1-phase 85 to 132VAC			
		Permissible frequency fluctuation	±5% maximum													
		Power consumption (W)	30					45					30			
	Interface power supply		24VDC ±10% (required current capacity: 150mA (Note 5))													
	Regenerative resistor/ tolerable regenerative power (W) (Note 3)	With no option (Amplifier built-in resistor)		—	10	10	10	20	20	100	100	130	170	—	10	10
		Optional regeneration unit	MR-RB032	30	30	30	30	30	30	×	×	×	×	30	30	30
			MR-RB12	×	100	100	100	100	100	×	×	×	×	×	100	100
			MR-RB30	×	×	×	×	×	×	300	300	×	×	×	×	×
			MR-RB31	×	×	×	×	×	×	×	×	300	300	×	×	×
			MR-RB32	×	×	×	×	300	300	×	×	×	×	×	×	×
			MR-RB50 (Note 4)	×	×	×	×	×	×	500	500	×	×	×	×	×
	MR-RB51 (Note 4)	×	×	×	×	×	×	×	×	500	500	×	×	×		
	Control system		Sine-wave PWM control/current control system													
	Dynamic brake		Built-in (Note 6)													
	Safety features		Overcurrent shutdown, regeneration overvoltage shutdown, overload shutdown (electronic thermal), servo motor overheat protection, encoder fault protection, regeneration fault protection, undervoltage/sudden power outage protection, overspeed protection, excess error protection													
	Structure		Self-cooling open (IP00)					Fan cooling open (IP00)					Self-cooling open (IP00)			
	Environment	Ambient temperature (Note 7)		0 to 55°C (32 to 131°F) (non freezing), storage: -20 to 65°C (-4 to 149°F) (non freezing)												
Ambient humidity		90% RH maximum (non condensing), storage: 90% RH maximum (non condensing)														
Atmosphere		Indoors (no direct sunlight); no corrosive gas, inflammable gas, oil mist or dust														
Elevation		1000m or less above sea level														
Vibration		5.9m/s <sup>2</sup> maximum														
Mass (kg [lb])		0.8 (1.8)	0.8 (1.8)	1.0 (2.2)	1.0 (2.2)	1.4 (3.1)	1.4 (3.1)	2.3 (5.1)	2.3 (5.1)	4.6 (10)	6.2 (14)	0.8 (1.8)	0.8 (1.8)	1.0 (2.2)		

- Notes: 1. Rated output and rated speed of the servo motor used in combination with the servo amplifier are as indicated when using the power supply voltage and frequency listed. The torque drops when the power supply voltage is less than specified.
2. For torque characteristics when combined with a servo motor, refer to the section "Servo motor torque characteristics" in this catalog.
3. Optimal regenerative resistor varies for each system. Select the most suitable regenerative resistor by using the capacity selection software. Note that the MR-J3-B type servo amplifier is planned to be compatible with the software version A3 or above.
4. Install the cooling fan (1.0m<sup>3</sup>/min, approx. □92).
5. 150mA is the value when all of the input/output points are used. The current capacity can be stepped down according to the number of input/output points in use. Refer to "MR-J3-□B SERVO AMPLIFIER INSTRUCTION MANUAL" for details.
6. Special specification models without a dynamic brake, MR-J3-□B-ED and MR-J3-□B1-ED, are also available.
7. The MR-J3-350B or smaller servo amplifier can be installed closely. In this case, keep the ambient temperature within 0 to 45°C (32 to 113°F), or use them with 75% or less of the effective load rate.
8. The special specification model, MR-J3-□B-U004, is also available for 1-phase 200 to 240VAC.

# Standard Wiring Diagram

## MR-J3-□B (1) type

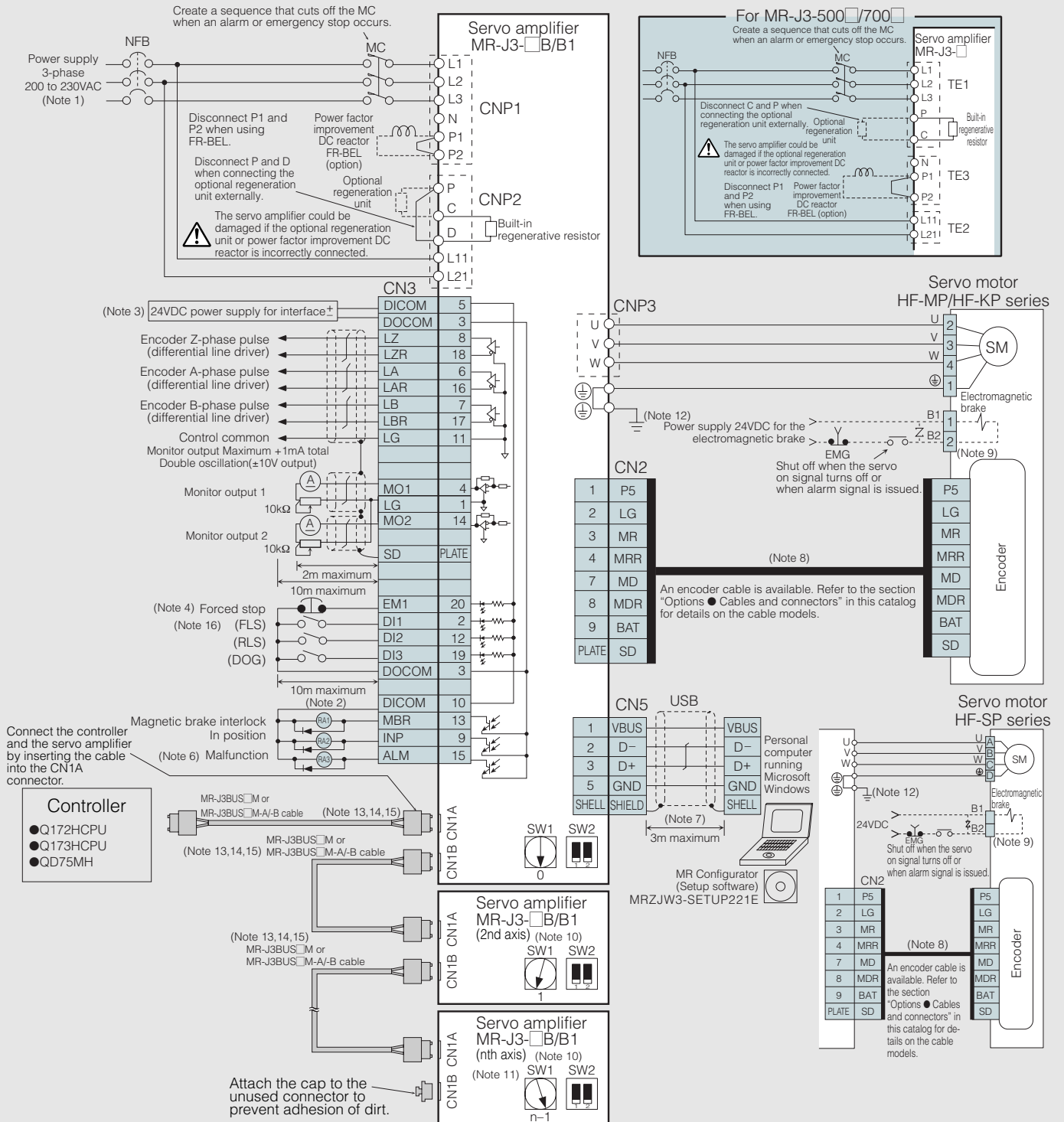

# Amplifier Dimensions

## MR-J3-□B(1) type

(Unit: mm)

### ● MR-J3-10B, 20B, 10B1, 20B1 (Note 1)

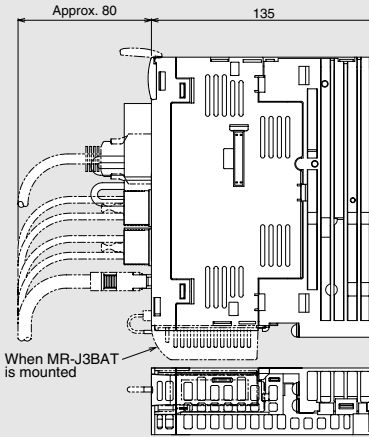
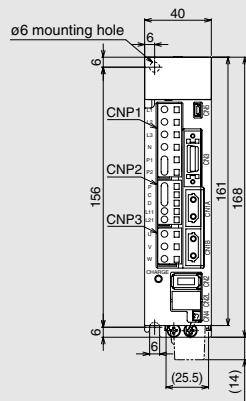

< Terminal arrangement >

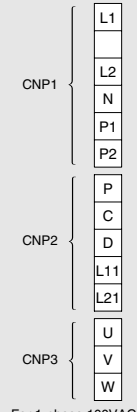

For 1-phase 100VAC

< Terminal arrangement >

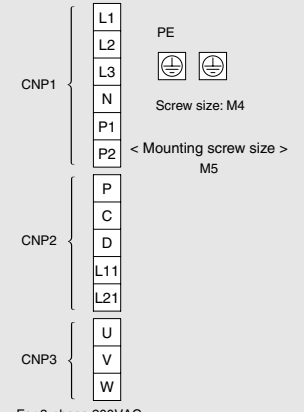

For 3-phase 200VAC or 1-phase 200VAC

### ● MR-J3-40B, 60B, 40B1 (Note 1)

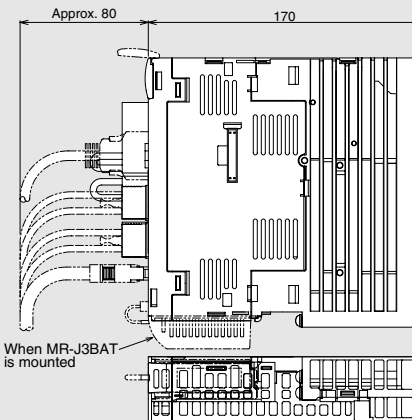
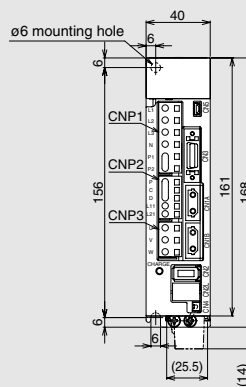

< Terminal arrangement >

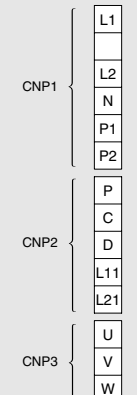

For 1-phase 100VAC

< Terminal arrangement >

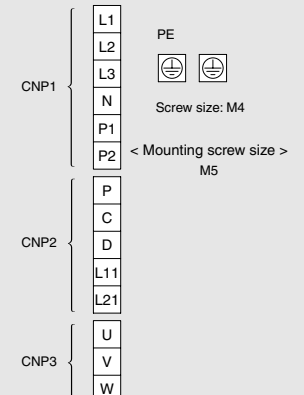

For 3-phase 200VAC or 1-phase 200VAC

### ● MR-J3-70B, 100B (Note 1)

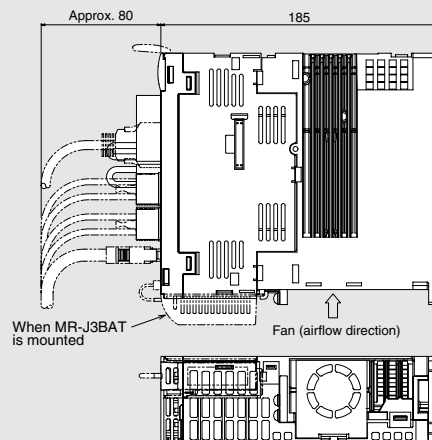
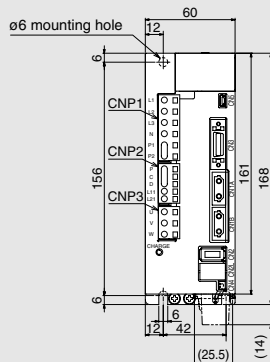

< Terminal arrangement >

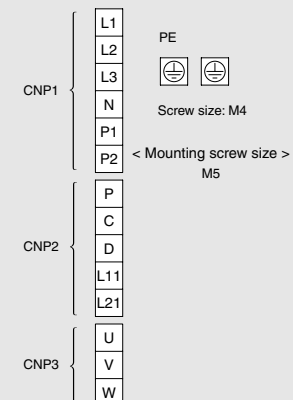

# Amplifier Dimensions

## ● MR-J3-200B, 350B (Note 1)

(Unit: mm)

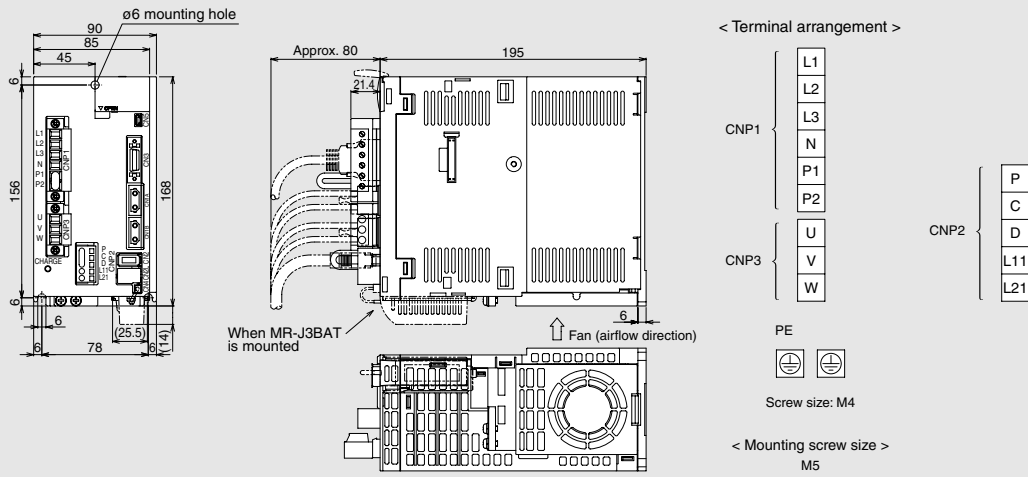

## ● MR-J3-500B

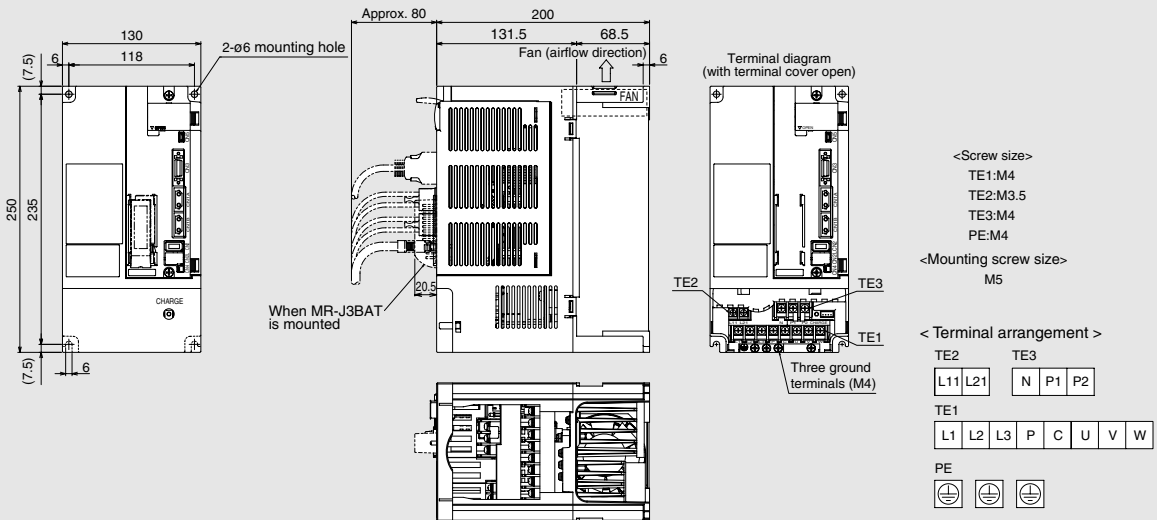

## ● MR-J3-700B

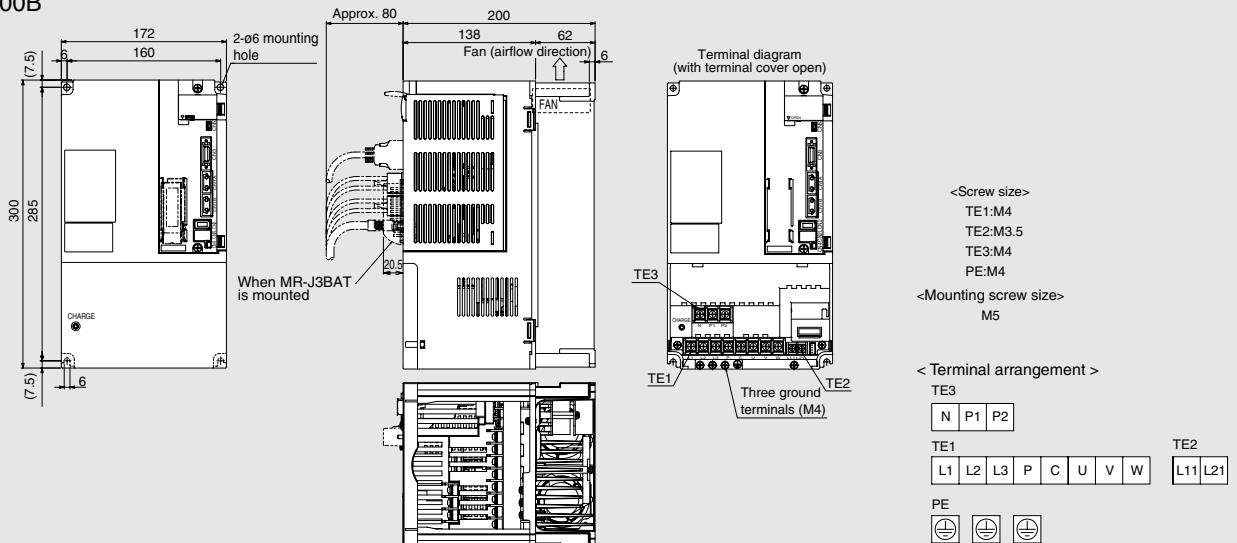



# Options

## ● Optional regeneration unit

Servo amplifier model	Built-in regenerative resistor/ tolerable regenerative power (W)	Optional regeneration unit/tolerable regenerative power (W)							Resistance value (Ω)
		MR-RB032	MR-RB12	MR-RB30	MR-RB31	MR-RB32	MR-RB50	MR-RB51	
MR-J3-10A(1) /B(1)	—	30	X	X	X	X	X	X	40
MR-J3-20A(1) /B(1)	10	30	100	X	X	X	X	X	40
MR-J3-40A(1) /B(1)	10	30	100	X	X	X	X	X	40
MR-J3-60A/B	10	30	100	X	X	X	X	X	40
MR-J3-70A/B	20	30	100	X	X	300	X	X	40
MR-J3-100A/B	20	30	100	X	X	300	X	X	40
MR-J3-200A/B	100	X	X	300	X	X	500	X	13
MR-J3-350A/B	100	X	X	300	X	X	500	X	13
MR-J3-500A/B	130	X	X	X	300	X	X	500	6.7
MR-J3-700A/B	170	X	X	X	300	X	X	500	6.7

Note: The tolerable regenerative power in the table differs from the regenerative resistor's rated wattage.

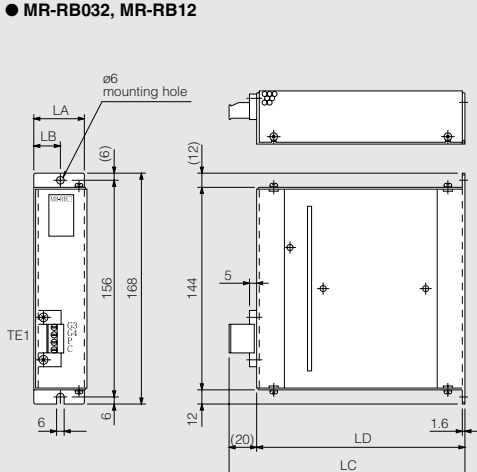
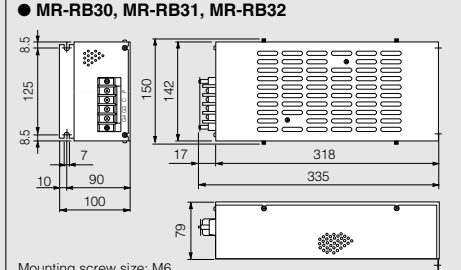
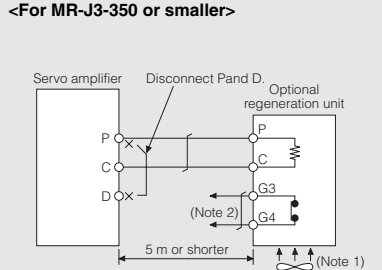
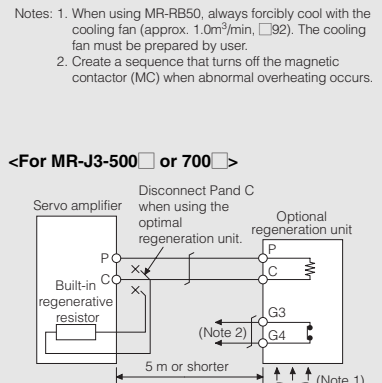
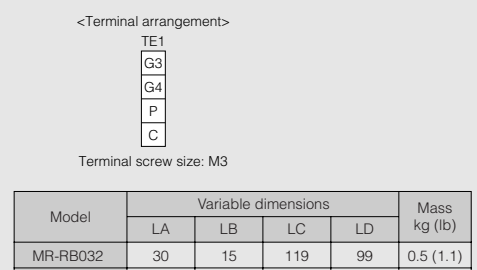
External dimensions		Connection																																								
(Unit: mm)		(Unit: mm)																																								
<p>● MR-RB032, MR-RB12</p>  <p>Mounting screw size: M5</p> <p>&lt;Terminal arrangement&gt;</p> <table border="1"> <tr><td>TE1</td></tr> <tr><td>G3</td></tr> <tr><td>G4</td></tr> <tr><td>P</td></tr> <tr><td>C</td></tr> </table> <p>Terminal screw size: M3</p> <table border="1"> <thead> <tr> <th rowspan="2">Model</th> <th colspan="4">Variable dimensions</th> <th rowspan="2">Mass kg (lb)</th> </tr> <tr> <th>LA</th> <th>LB</th> <th>LC</th> <th>LD</th> </tr> </thead> <tbody> <tr> <td>MR-RB032</td> <td>30</td> <td>15</td> <td>119</td> <td>99</td> <td>0.5 (1.1)</td> </tr> <tr> <td>MR-RB12</td> <td>40</td> <td>15</td> <td>169</td> <td>149</td> <td>1.1 (2.4)</td> </tr> </tbody> </table>	TE1	G3	G4	P	C	Model	Variable dimensions				Mass kg (lb)	LA	LB	LC	LD	MR-RB032	30	15	119	99	0.5 (1.1)	MR-RB12	40	15	169	149	1.1 (2.4)	<p>● MR-RB30, MR-RB31, MR-RB32</p>  <p>Mounting screw size: M6</p> <p>&lt;Terminal arrangement&gt;</p> <table border="1"> <tr><td>P</td></tr> <tr><td>C</td></tr> <tr><td>G3</td></tr> <tr><td>G4</td></tr> </table> <p>Terminal screw size: M4</p> <table border="1"> <thead> <tr> <th rowspan="2">Model</th> <th rowspan="2">Mass kg (lb)</th> </tr> </thead> <tbody> <tr> <td>MR-RB30</td> <td>2.9 (6.4)</td> </tr> <tr> <td>MR-RB31</td> <td>2.9 (6.4)</td> </tr> <tr> <td>MR-RB32</td> <td>2.9 (6.4)</td> </tr> </tbody> </table>	P	C	G3	G4	Model	Mass kg (lb)	MR-RB30	2.9 (6.4)	MR-RB31	2.9 (6.4)	MR-RB32	2.9 (6.4)	<p>&lt;For MR-J3-350 or smaller&gt;</p>  <p>Notes: 1. When using MR-RB50, always forcibly cool with the cooling fan (approx. 1.0m<sup>3</sup>/min, □92). The cooling fan must be prepared by user. 2. Create a sequence that turns off the magnetic contactor (MC) when abnormal overheating occurs.</p>	<p>&lt;For MR-J3-500 or 700&gt;</p>  <p>Notes: 1. When using MR-RB51, always forcibly cool with the cooling fan (approx. 1.0m<sup>3</sup>/min, □92). The cooling fan must be prepared by user. 2. Create a sequence that turns off the magnetic contactor (MC) when abnormal overheating occurs.</p>
TE1																																										
G3																																										
G4																																										
P																																										
C																																										
Model	Variable dimensions				Mass kg (lb)																																					
	LA	LB	LC	LD																																						
MR-RB032	30	15	119	99	0.5 (1.1)																																					
MR-RB12	40	15	169	149	1.1 (2.4)																																					
P																																										
C																																										
G3																																										
G4																																										
Model	Mass kg (lb)																																									
		MR-RB30	2.9 (6.4)																																							
MR-RB31	2.9 (6.4)																																									
MR-RB32	2.9 (6.4)																																									
<p>● MR-RB50, MR-RB51</p>  <p>Mounting screw size: M6</p> <p>&lt;Terminal arrangement&gt;</p> <table border="1"> <tr><td>P</td></tr> <tr><td>C</td></tr> <tr><td>G3</td></tr> <tr><td>G4</td></tr> </table> <p>Terminal screw size: M4</p> <table border="1"> <thead> <tr> <th rowspan="2">Model</th> <th rowspan="2">Mass kg (lb)</th> </tr> </thead> <tbody> <tr> <td>MR-RB50</td> <td>5.6 (12)</td> </tr> <tr> <td>MR-RB51</td> <td>5.6 (12)</td> </tr> </tbody> </table>	P	C	G3	G4	Model	Mass kg (lb)	MR-RB50	5.6 (12)	MR-RB51	5.6 (12)	<p>Notes: 1. The optional regeneration unit will heat up to approx. 100°C (212°F), so do not directly mount it on a wall susceptible to heat. Use nonflammable wires or provide flame resistant treatment (use silicon tubes, etc.), and wire so that the wires do not contact the optional regeneration unit. 2. Always use twisted wires for the optional regeneration unit, and keep the length as short as possible (5m or shorter). 3. Always use twisted wires for a thermal sensor, and make sure that the sensor does not fail to work properly due to inducted noise.</p>																															
P																																										
C																																										
G3																																										
G4																																										
Model	Mass kg (lb)																																									
		MR-RB50	5.6 (12)																																							
MR-RB51	5.6 (12)																																									

## ● Junction terminal block (MR-TB50): only for the MR-J3-A type

All signals can be received with this junction terminal block without a connection to CN1.

## ● Junction terminal block (PS7DW-20V14B-F)

For the MR-J3-B type, use PS7DW-20V14B-F recommended. MR-TB20 cannot be used.

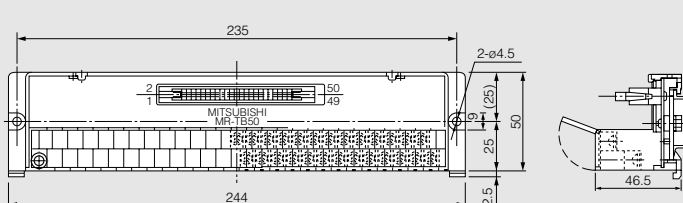
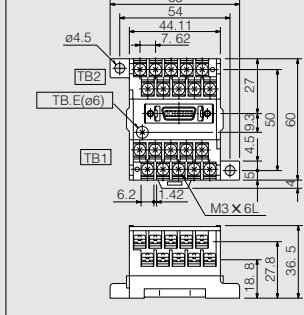
 <p>Terminal block screw size: M3.5 Compatible wire: 2mm<sup>2</sup> (AWG14) maximum Crimping terminal width: 7.2mm maximum</p>	 <p>● Manufacturer: YOSHIDA ELECTRIC INDUSTRY. * Use the junction terminal block cable, MR-J2HBUS□M. MR-J2TB□□M can not be used.</p> <p>Compatible wire: 1.25mm<sup>2</sup> (AWG16) maximum</p>
(Unit: mm)	(Unit: mm)

# Options

## ● Cables and connectors (MR-J3-A type)

Optional cables and connectors are shown in the diagram below.

### <Servo motor HF-MP/HF-KP series: encoder cable length 10m or shorter>

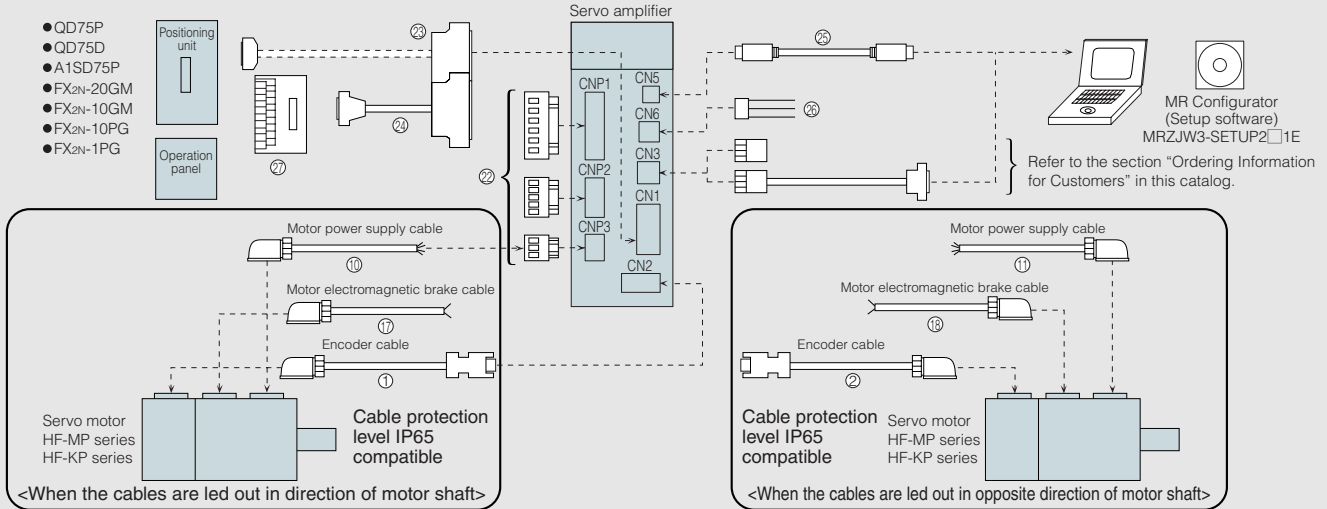

### <Servo motor HF-MP/HF-KP series: Encoder cable length over 10m>

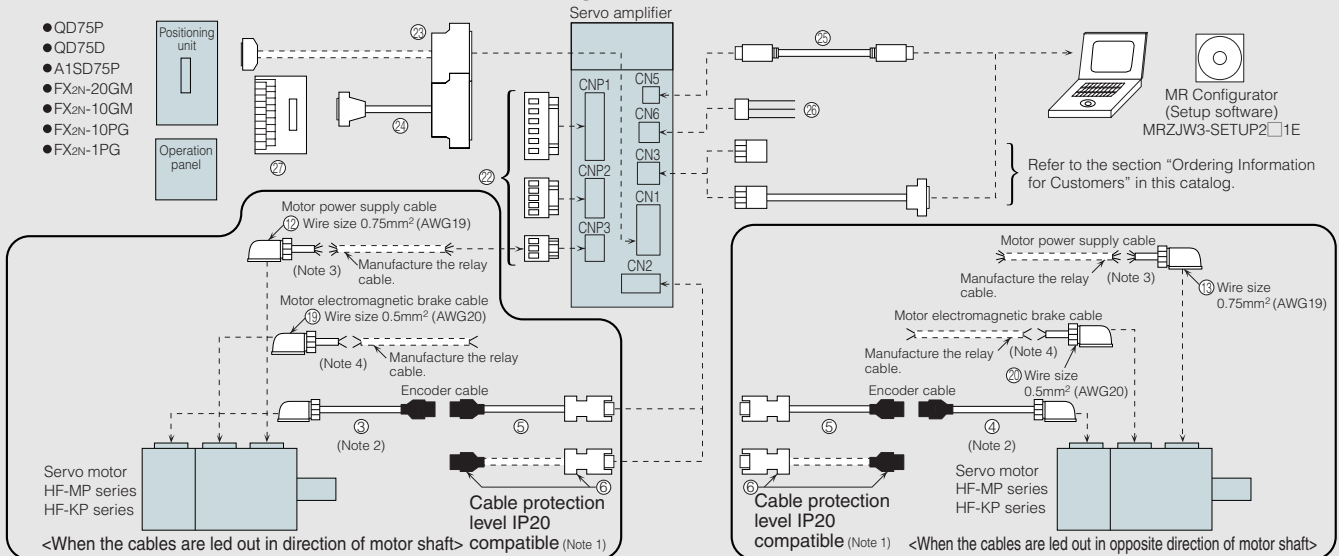

Notes: 1. Compatible with protection level IP20. Contact Mitsubishi when using in a protection level IP65 environment.

2. This cable does not have a long bending life, so always fix the cable before using.







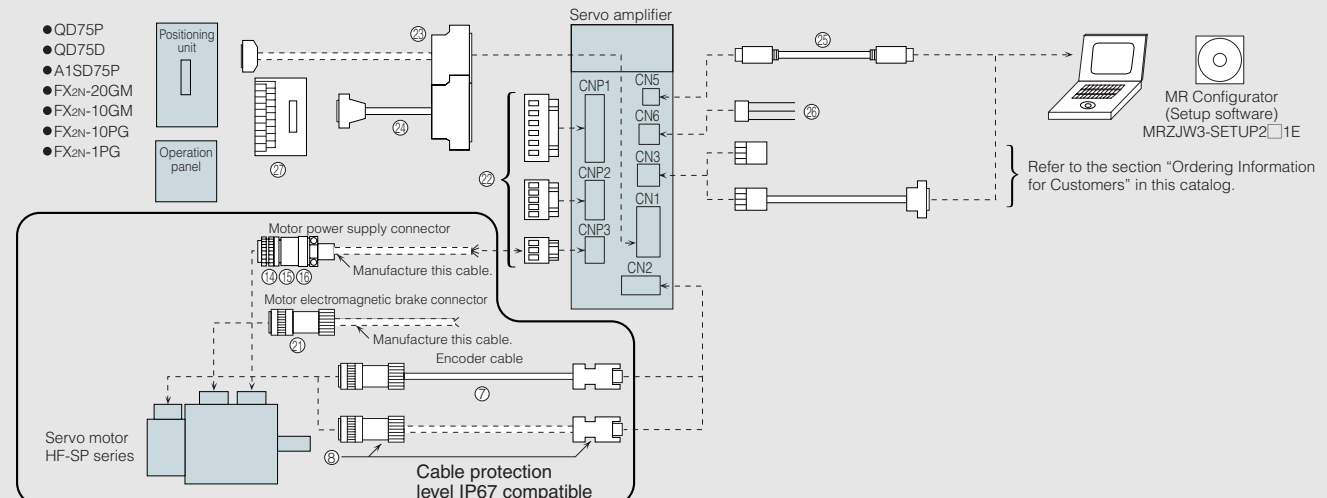

3. If the length exceeds 10m, relay the cable using the cable MR-PWS2CBL03M-A1-L/A2-L. This cable does not have a long bending life, so always fix the cable before using. Refer to "MR-J3-□A SERVO AMPLIFIER INSTRUCTION MANUAL" for details on manufacturing the relay cable.

4. If the length exceeds 10m, relay the cable using the cable MR-BKS2CBL03M-A1-L/A2-L. This cable does not have a long bending life, so always fix the cable before using. Refer to "MR-J3-□A SERVO AMPLIFIER INSTRUCTION MANUAL" for details on manufacturing the relay cable.

### <For servo motor HF-SP series>



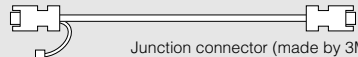















## ● Cables and connectors

Item			Model	Protection level	Description
Encoder cable for CN2	① 10m or shorter (Direct connection type)	Encoder cable for HF-MP/HF-KP series motor Lead out in direction of motor shaft	MR-J3ENCBL□M-A1-H □=cable length 2, 5, 10m (Note 1)	IP65	Encoder-side connector (made by Tyco Electronics AMP) 1674320-1  Amplifier-side connector (made by 3M or an equivalent product) 36210-0100JL (receptacle) 36310-3200-008 (shell kit)
			MR-J3ENCBL□M-A1-L □=cable length 2, 5, 10m (Note 1)	IP65	
		Encoder cable for HF-MP/HF-KP series motor Lead out in opposite direction of motor shaft	MR-J3ENCBL□M-A2-H □=cable length 2, 5, 10m (Note 1)	IP65	
			MR-J3ENCBL□M-A2-L □=cable length 2, 5, 10m (Note 1)	IP65	
	③	Encoder cable for HF-MP/HF-KP series motor Lead out in direction of motor shaft	MR-J3JCBL03M-A1-L Cable length 0.3m (Note 1)	IP20	Encoder-side connector (made by Tyco Electronics AMP) 1674320-1  Junction connector (made by Tyco Electronics AMP) 1473226-1 (with ring) (contact) 1-172169-9 (housing) 316454-1 (cable clamp)
			MR-J3JCBL03M-A2-L Cable length 0.3m (Note 1)	IP20	
	④ Exceeding 10m (Relay type)	Encoder cable for HF-MP/HF-KP series motor Lead out in opposite direction of motor shaft	MR-J3JCBL03M-A1-L Cable length 0.3m (Note 1)	IP20	Use this in combination of ⑤ or ⑥.
			MR-J3JCBL03M-A2-L Cable length 0.3m (Note 1)	IP20	
	⑤	Amplifier-side cable for HF-MP/HF-KP series motor	MR-EKCBL□M-H □=cable length 20, 30, 40, 50m (Note 1)	IP20	Junction connector (made by Tyco Electronics AMP) 1-172161-9 (housing) 170359-1 (connector pin) MTI-0002 (cable clamp, made by TOA ELECTRIC INDUSTRIAL) Amplifier-side connector (made by 3M or an equivalent product) 36210-0100JL (receptacle) 36310-3200-008 (shell kit)  Use this in combination of ③ or ④.
			MR-EKCBL□M-L □=cable length 20, 30m (Note 1)	IP20	
	⑥ Exceeding 10m (Relay type)	Junction connector, Amplifier-side connector (Note 2) for HF-MP/HF-KP series motor	MR-ECNM	IP20	Junction connector (made by Tyco Electronics AMP) 1-172161-9 (housing) 170359-1 (connector pin) MTI-0002 (cable clamp, made by TOA ELECTRIC INDUSTRIAL) Amplifier-side connector (made by Molex or an equivalent product) 54593-1011 (connector housing) 54594-1015 (plug cover A) 54595-1005 (plug cover B) 58935-1000 (shell cover) 58934-1000 (shell body) 58937-0000 (cable clamp) 58203-0010 (screw) (Note 3) Use these in combination of ③ or ④.  Amplifier-side connector (made by Molex or an equivalent product) 54593-1011 (connector housing) 54594-1015 (plug cover A) 54595-1005 (plug cover B) 58935-1000 (shell cover) 58934-1000 (shell body) 58937-0000 (cable clamp) 58203-0010 (screw) (Note 3) <Applicable cable example> Wire size: 0.3mm <sup>2</sup> (AWG22) Completed cable outer diameter: φ8.2mm Crimping tool (91529-1) is required.
			MR-ECNM	IP20	
⑦	Encoder cable for HF-SP series motor	MR-J3ENSCLB□M-H □=cable length 2, 5, 10, 20, 30, 40, 50m (Note 1)	IP67	Encoder-side connector (made by DDK) <For 10m or shorter cable> CM10-SP10S-M (straight plug) CM10-#22SC (C1) -100 (socket contact) Amplifier-side connector (made by 3M or an equivalent product) 36210-0100JL (receptacle) 36310-3200-008 (shell kit) <For over 10m cable> CM10-SP10S-M (straight plug) CM10-#22SC (C2) -100 (socket contact) 	
		MR-J3ENSCLB□M-L □=cable length 2, 5, 10, 20, 30m (Note 1)	IP67		
⑧	Encoder connector set for HF-SP series motor	MR-J3SCNS	IP67	Amplifier-side connector (made by Molex or an equivalent product) 54593-1011 (connector housing) 54594-1015 (plug cover A) 54595-1005 (plug cover B) 58935-1000 (shell cover) 58934-1000 (shell body) 58937-0000 (cable clamp) 58203-0010 (screw) (Note 3) Encoder-side connector (made by DDK) CM10-SP10S-M (straight plug) CM10-#22SC (S1) -100 (socket contact) <Applicable cable example> Wire size: 0.5mm <sup>2</sup> (AWG20) or less Completed cable outer diameter: φ6.0 to 9.0mm 	
		MR-J3SCNS	IP67		
⑨	Battery connection relay cable	MR-J3BTCBL03M Cable length 0.3m (Note 4)	—	Amplifier-side CN2 connector (made by 3M or an equivalent product) 36210-0100JL (receptacle) 36310-3200-008 (shell kit) Battery-side connector (made by HIROSE ELECTRIC) DF3-2EP-2C (plug) DF3-EP2428PCA (Crimping terminal for plug) 2 pcs. Junction connector (made by 3M) 36110-3000FD (plug) 36310-F200-008 (shell kit) Not required when the servo system is used in an incremental mode. Refer to the section "Options ● Battery connection relay cable" for details. 	
		MR-J3BTCBL03M Cable length 0.3m (Note 4)	—		
Select one of motor power supply cables ⑩ to ⑪ for use	⑩ 10m or shorter (Direct connection type)	Power supply cable for HF-MP/HF-KP series motor Lead out in direction of motor shaft	MR-PWS1CBL□M-A1-H □=cable length 2, 5, 10m (Note 1)	IP65	Motor power supply-side connector (made by Japan Aviation Electronics Industry) JN4FT04SJ1 (plug) ST-TMH-S-C1B-100-(A534G) (socket contact)  Lead-out
			MR-PWS1CBL□M-A1-L □=cable length 2, 5, 10m (Note 1)	IP65	
	Power supply cable for HF-MP/HF-KP series motor Lead out in opposite direction of motor shaft	MR-PWS1CBL□M-A2-H □=cable length 2, 5, 10m (Note 1)	IP65		
		MR-PWS1CBL□M-A2-L □=cable length 2, 5, 10m (Note 1)	IP65		

- Notes: 1. -H and -L indicate a bending life. -H indicates a long bending life, and -L indicates a standard bending life.  
2. Refer to "MR-J3-□A SERVO AMPLIFIER INSTRUCTION MANUAL" for details on manufacturing the cable.  
3. 3M connector can be used for the amplifier-side connector. Model: 36210-0100JL (receptacle), 36310-3200-008 (shell kit)  
4. The battery connection relay cable (MR-J3BTCBL03M) has a diode built-in. Do not manufacture this cable. This optional cable must be used.

## ● Cables and connectors

Item		Model	Protection level	Description	
Select one of motor power supply cables (10) to (16) for use	12	Power supply cable for HF-MP/HF-KP series motor Lead out in direction of motor shaft	MR-PWS2CBL03M-A1-L Cable length 0.3m (Note 1)	IP55	Motor power supply-side connector (made by Japan Aviation Electronics Industry) JN4FT04SJ1 (plug) ST-TMH-S-C1B-100-(A534G) (socket contact)
	13	Exceeding 10m (Relay type) Power supply cable for HF-MP/HF-KP series motor Lead out in opposite direction of motor shaft	MR-PWS2CBL03M-A2-L Cable length 0.3m (Note 1)	IP55	 Lead-out
	14	Power supply connector for HF-SP51, 81, HF-SP52, 102, 152	MR-PWCNS4 (Straight type)	IP67	 Motor power supply connector (made by DDK) CE05-6A18-10SD-B-BSS (plug) (straight) CE3057-10A-1 (D265) (cable clamp) <Applicable cable example> Wire size: 2mm <sup>2</sup> (AWG14) to 3.5mm <sup>2</sup> (AWG12) Completed cable outer diameter: φ10.5 to 14.1mm
	15	Power supply connector for HF-SP121, 201, HF-SP202, 352, 502	MR-PWCNS5 (Straight type)	IP67	 Motor power supply connector (made by DDK) CE05-6A22-22SD-B-BSS (plug) (straight) CE3057-12A-1 (D265) (cable clamp) <Applicable cable example> Wire size: 5.5mm <sup>2</sup> (AWG10) to 8mm <sup>2</sup> (AWG8) Completed cable outer diameter: φ12.5 to 16mm
	16	Power supply connector for HF-SP702	MR-PWCNS3 (Straight type)	IP67	 Plug (straight) (made by DDK) CE05-6A32-17SD-B-BSS  Cable clamp (made by DDK) CE3057-20A-1 (D265) <Applicable cable example> Wire size: 14mm <sup>2</sup> (AWG6) to 22mm <sup>2</sup> (AWG4) Completed cable outer diameter: φ22 to 23.8mm
Select one of motor brake cables for use	17	10m or shorter (Direct connection type) Brake cable for HF-MP/HF-KP series motor Lead out in direction of motor shaft	MR-BKS1CBL□M-A1-H □=cable length 2, 5, 10m (Note 1)	IP65	Motor brake-side connector (made by Japan Aviation Electronics Industry) JN4FT02SJ1 (plug) ST-TMH-S-C1B-100-(A534G) (socket contact)  Lead-out
	MR-BKS1CBL□M-A1-L □=cable length 2, 5, 10m (Note 1)		IP65		
	18	Brake cable for HF-MP/HF-KP series motor Lead out in opposite direction of motor shaft	MR-BKS1CBL□M-A2-H □=cable length 2, 5, 10m (Note 1)	IP65	
			MR-BKS1CBL□M-A2-L □=cable length 2, 5, 10m (Note 1)	IP65	
	19	Exceeding 10m (Relay type) Brake cable for HF-MP/HF-KP series motor Lead out in direction of motor shaft	MR-BKS2CBL03M-A1-L Cable length 0.3m (Note 1)	IP55	
	20	Brake cable for HF-MP/HF-KP series motor Lead out in opposite direction of motor shaft	MR-BKS2CBL03M-A2-L Cable length 0.3m (Note 1)	IP55	
21	Brake connector for HF-SP series motor	MR-BKCNS1 (Straight type)	IP67	 Motor brake connector (made by DDK) (Soldered type) CM10-SP2S-L (Straight plug) CM10-#22SC(S2)-100(socket contact) <Applicable cable example> Wire size: 1.25mm <sup>2</sup> (AWG16) or less Completed cable outer diameter: φ9.0 to 11.6mm	
For CNP1, CNP2, CNP3	22	Servo amplifier power supply connector set for MR-J3-10A (1) to MR-J3-350A (Note 4)	(Standard accessory: Insertion type)	—	 CNP1 connector • For 1kW or less (made by Molex or an equivalent product) 54928-0610 (connector) • For 2, 3.5kW (PHOENIX or an equivalent product) PC4/6-STF-7.62-CRWH (connector)   CNP2 connector (made by Molex or an equivalent product) 54927-0510 (connector)   CNP3 connector • For 1kW or less (made by Molex or an equivalent product) 54928-0310 (connector) • For 2, 3.5kW (PHOENIX or an equivalent product) PC4/3-STF-7.62-CRWH (connector)   Insertion tool (made by Molex or an equivalent product) 54932-0000  <Applicable cable example> (Note 3) • CNP2 connector for 1kW or less, 2 and 3.5kW Wire size: 0.14mm <sup>2</sup> (AWG26) to 2.5mm <sup>2</sup> (AWG14) Completed cable outer diameter: to φ3.8mm  <Applicable cable example> (Note 3) • CNP1 and CNP3 connectors for 2 and 3.5kW Wire size: 0.2mm <sup>2</sup> (AWG24) to 5.5mm <sup>2</sup> (AWG10) Completed cable outer diameter: to φ5mm
For CN1	23	CN1 connector	MR-J3CN1	—	 Amplifier-side connector (made by 3M or an equivalent product) 10150-3000VE (connector) 10350-52F0-008 (shell kit)
	24	Junction terminal block cable	MR-J2M-CN1TBL□M □=cable length 0.5, 1m	—	 Junction terminal block-side connector (made by 3M) D7950-B500FL (connector)  Amplifier-side connector (made by 3M or an equivalent product) 10150-6000EL (connector) 10350-3210-000 (shell kit) (Note 2)
For CN5	25	Personal computer communication cable USB cable	MR-J3USBCBL3M Cable length 3m	—	Amplifier-side connector mini-B connector (5 pins)  Personal computer-side connector A connector
For CN6	26	Monitor cable	MR-J3CN6CBL1M Cable length 1m	—	 Amplifier-side connector (made by Molex) 51004-0300 (housing) 50011-8100 (terminal)
	27	Junction terminal block	MR-TB50	—	

Notes: 1. -H and -L indicate a bending life. -H indicates a long bending life, and -L indicates a standard bending life.  
2. The connector and the shell kit are press bonding type. Models for soldered type are 10150-3000VE (connector) and 10350-52F0-008 (shell kit).  
3. Refer to the section "Peripheral Equipment" ● Electrical wires, circuit breakers, magnetic contactors" in this catalog for details on electrical wire size recommended.  
4. The connector type terminal block is available only for the MR-J3-350A or smaller servo amplifier. Refer to the section "Amplifier Dimensions" for details.

## ● Cables and connectors (MR-J3-B type)

Optional cables and connectors are shown in the diagram below.

### <Servo motor HF-MP/HF-KP series: encoder cable length 10m or shorter>

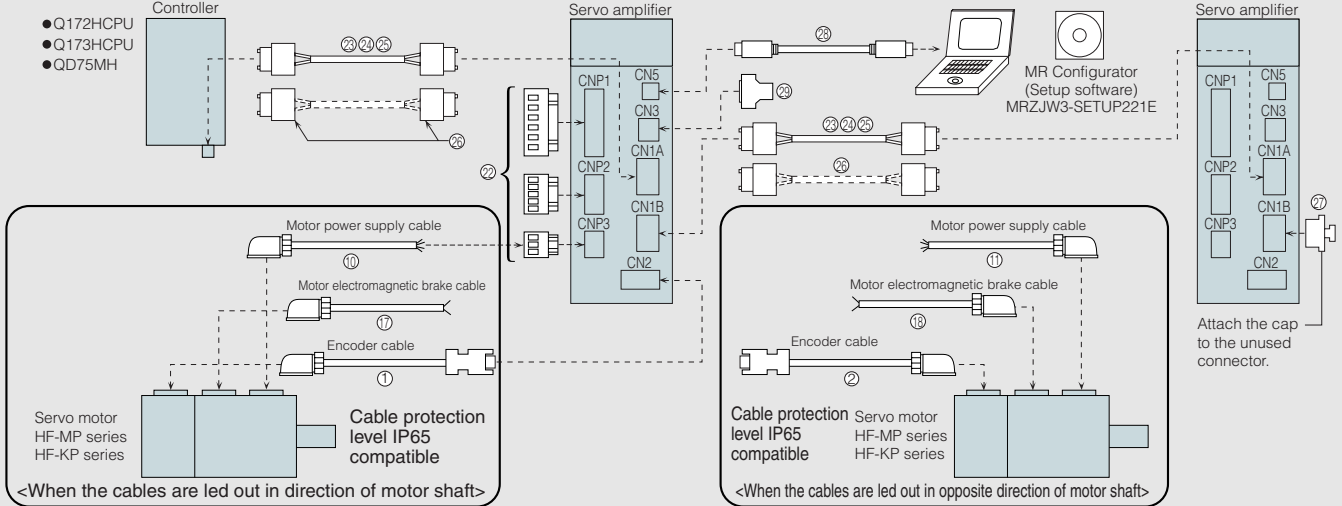

### <Servo motor HF-MP/HF-KP series: Encoder cable length over 10m>

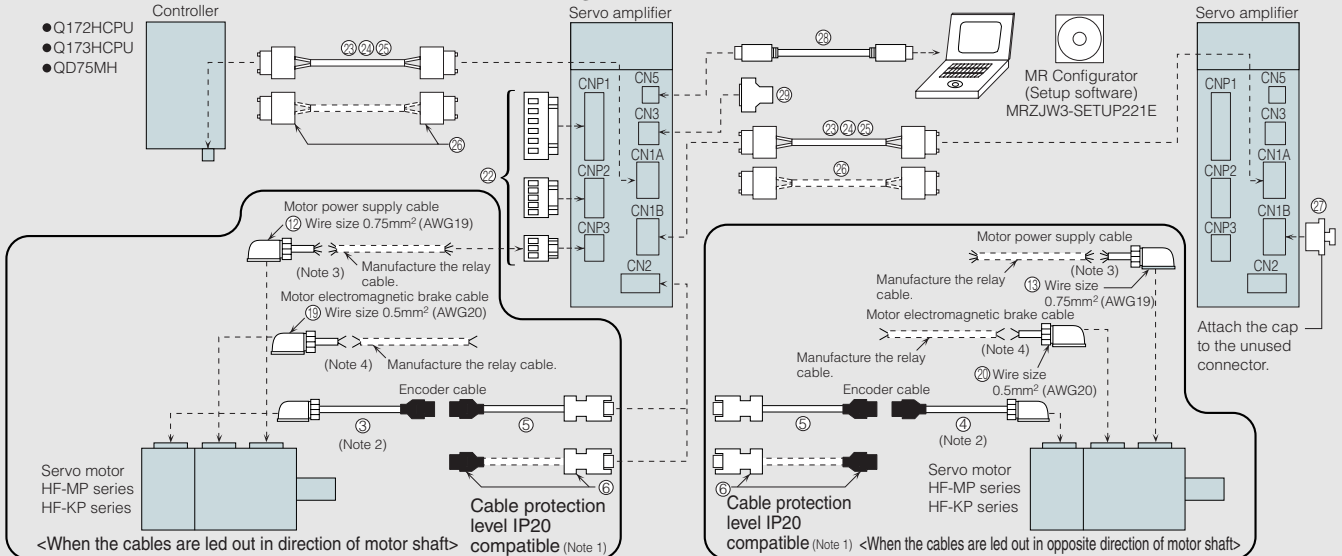

Notes: 1. Compatible with protection level IP20. Contact Mitsubishi when using in a protection level IP65 environment.

2. This cable does not have a long bending life, so always fix the cable before using.

3. If the length exceeds 10m, relay the cable using the cable MR-PWS2CBL03M-A1-L/A2-L. This cable does not have a long bending life, so always fix the cable before using. Refer to "MR-J3-B SERVO AMPLIFIER INSTRUCTION MANUAL" for details on manufacturing the relay cable.





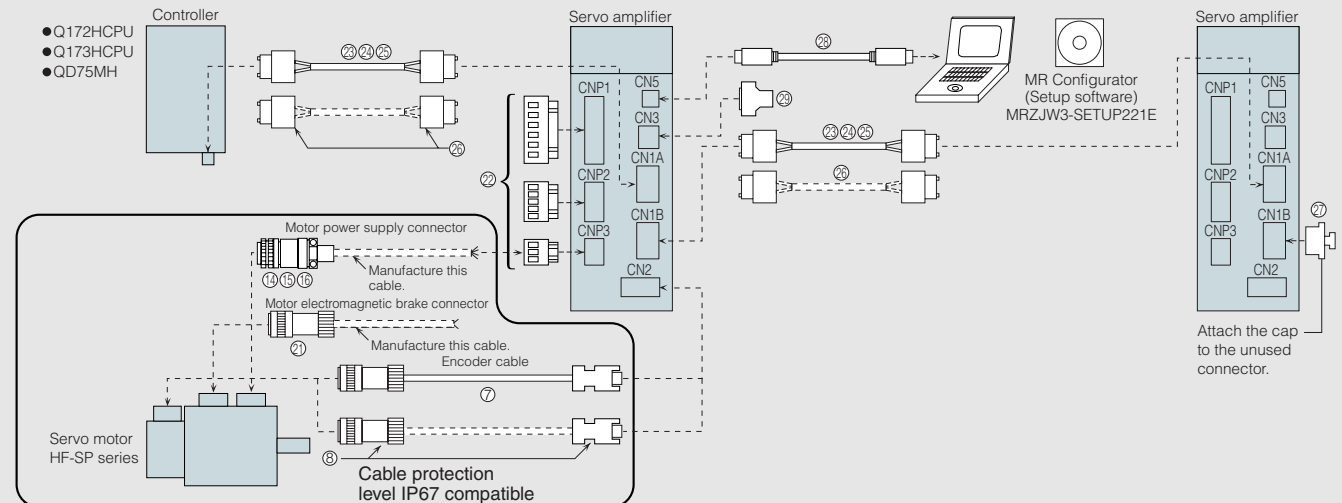



4. If the length exceeds 10m, relay the cable using the cable MR-BKS2CBL03M-A1-L/A2-L. This cable does not have a long bending life, so always fix the cable before using. Refer to "MR-J3-B SERVO AMPLIFIER INSTRUCTION MANUAL" for details on manufacturing the relay cable.

### <For servo motor HF-SP series>





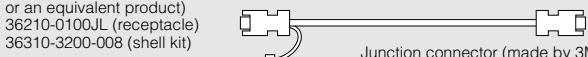







# Options

## ● Cables and connectors

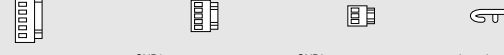
Item		Model	Protection level	Description		
Encoder cable for CN2	① 10m or shorter (Direct connection type)	Encoder cable for HF-MP/HF-KP series motor Lead out in direction of motor shaft	MR-J3ENCBL□M-A1-H □=cable length 2, 5, 10m (Note 1)	IP65	Encoder-side connector (made by Tyco Electronics AMP) 1674320-1  Amplifier-side connector (made by 3M or an equivalent product) 36210-0100JL (receptacle) 36310-3200-008 (shell kit)	
		Encoder cable for HF-MP/HF-KP series motor Lead out in opposite direction of motor shaft	MR-J3ENCBL□M-A1-L □=cable length 2, 5, 10m (Note 1)	IP65		
	②	Encoder cable for HF-MP/HF-KP series motor Lead out in direction of motor shaft	MR-J3ENCBL□M-A2-H □=cable length 2, 5, 10m (Note 1)	IP65		
		Encoder cable for HF-MP/HF-KP series motor Lead out in opposite direction of motor shaft	MR-J3ENCBL□M-A2-L □=cable length 2, 5, 10m (Note 1)	IP65		
	③	Encoder cable for HF-MP/HF-KP series motor Lead out in direction of motor shaft	MR-J3JCBL03M-A1-L Cable length 0.3m (Note 1)	IP20	Encoder-side connector (made by Tyco Electronics AMP) 1674320-1  Junction connector (made by Tyco Electronics AMP) 1473226-1 (with ring) (contact) 1-172169-9 (housing) 316454-1 (cable clamp)	
		Encoder cable for HF-MP/HF-KP series motor Lead out in opposite direction of motor shaft	MR-J3JCBL03M-A2-L Cable length 0.3m (Note 1)	IP20		
	④ Exceeding 10m (Relay type)	Amplifier-side cable for HF-MP/HF-KP series motor	MR-EKCBL□M-H □=cable length 20, 30, 40, 50m (Note 1)	IP20	Junction connector (made by Tyco Electronics AMP) 1-172161-9 (housing) 170359-1 (connector pin) MTI-0002 (cable clamp, made by TOA ELECTRIC INDUSTRIAL) Amplifier-side connector (made by 3M or an equivalent product) 36210-0100JL (receptacle) 36310-3200-008 (shell kit)  Use this in combination of ③ or ④.	
			MR-EKCBL□M-L □=cable length 20, 30m (Note 1)	IP20		
	⑤	Exceeding 10m (Relay type)	Junction connector, Amplifier-side connector (Note 2) for HF-MP/HF-KP series motor	MR-ECNM	IP20	Junction connector (made by Tyco Electronics AMP) 1-172161-9 (housing) 170359-1 (connector pin) MTI-0002 (cable clamp, made by TOA ELECTRIC INDUSTRIAL) Amplifier-side connector (made by Molex or an equivalent product) 54593-1011 (connector housing) 54594-1015 (plug cover A) 54595-1005 (plug cover B) 58935-1000 (shell cover) 58934-1000 (shell body) 58937-0000 (cable clamp) 58203-0010 (screw) (Note 3) Use these in combination of ③ or ④. 
				<Applicable cable example> Wire size: 0.3mm <sup>2</sup> (AWG22) Completed cable outer diameter: φ8.2mm Crimping tool (91529-1) is required.		
⑥	Encoder cable for HF-SP series motor	MR-J3ENSCBL□M-H □=cable length 2, 5, 10, 20, 30, 40, 50m (Note 1)	IP67	Encoder-side connector (made by DDK) <For 10m or shorter cable> CM10-SP10S-M (straight plug) CM10-#22SC (C1) -100 (socket contact)  Amplifier-side connector (made by 3M or an equivalent product) 36210-0100JL (receptacle) 36310-3200-008 (shell kit) <For exceeding 10m cable> CM10-SP10S-M (straight plug) CM10-#22SC (C2) -100 (socket contact)		
		MR-J3ENSCBL□M-L □=cable length 2, 5, 10, 20, 30m (Note 1)	IP67			
⑦	Encoder connector set for HF-SP series motor	MR-J3SCNS	IP67	Encoder-side connector (made by DDK) CM10-SP10S-M (straight plug) CM10-#22SC (S1) -100 (socket contact)  <Applicable cable example> Wire size: 0.5mm <sup>2</sup> (AWG20) or less Completed cable outer diameter: φ6.0 to 9.0mm		
				Amplifier-side connector (made by Molex or an equivalent product) 54593-1011 (connector housing) 54594-1015 (plug cover A) 54595-1005 (plug cover B) 58935-1000 (shell cover) 58934-1000 (shell body) 58937-0000 (cable clamp) 58203-0010 (screw) (Note 3)		
⑧	Battery connection relay cable	MR-J3BTCBL03M Cable length 0.3m (Note 4)	—	Amplifier-side CN2 connector (made by 3M or an equivalent product) 36210-0100JL (receptacle) 36310-3200-008 (shell kit) Battery-side connector (made by HIROSE ELECTRIC) DF3-2EP-2C (plug) DF3-EP2428PCA (Crimping terminal for plug) 2 pcs. Junction connector (made by 3M) 36110-3000FD (plug) 36310-F200-008 (shell kit) Not required when the servo system is used in an incremental mode. Refer to the section "Options ● Battery connection relay cable" for details. 		
Select one of motor power supply cables ⑩ to ⑬ for use	⑩ 10m or shorter (Direct connection type)	Power supply cable for HF-MP/HF-KP series motor Lead out in direction of motor shaft	MR-PWS1CBL□M-A1-H □=cable length 2, 5, 10m (Note 1)	IP65	Motor power supply-side connector (made by Japan Aviation Electronics Industry) JN4FT04SJ1 (plug) ST-TMH-S-C1B-100-(A534G) (socket contact)  Lead-out	
		Power supply cable for HF-MP/HF-KP series motor Lead out in opposite direction of motor shaft	MR-PWS1CBL□M-A1-L □=cable length 2, 5, 10m (Note 1)	IP65		
	⑪	Power supply cable for HF-MP/HF-KP series motor Lead out in direction of motor shaft	MR-PWS1CBL□M-A2-H □=cable length 2, 5, 10m (Note 1)	IP65		
		Power supply cable for HF-MP/HF-KP series motor Lead out in opposite direction of motor shaft	MR-PWS1CBL□M-A2-L □=cable length 2, 5, 10m (Note 1)	IP65		
⑫ Exceeding 10m (Relay type)	Power supply cable for HF-MP/HF-KP series motor Lead out in direction of motor shaft	MR-PWS2CBL03M-A1-L Cable length 0.3m (Note 1)	IP55			
		Power supply cable for HF-MP/HF-KP series motor Lead out in opposite direction of motor shaft	MR-PWS2CBL03M-A2-L Cable length 0.3m (Note 1)	IP55		

- Notes: 1. -H and -L indicate a bending life. -H indicates a long bending life, and -L indicates a standard bending life.  
2. Refer to "MR-J3-□B SERVO AMPLIFIER INSTRUCTION MANUAL" for details on manufacturing the cable.  
3. 3M connector can be used for the amplifier-side connector. Model: 36210-0100JL (receptacle), 36310-3200-008 (shell kit)  
4. The battery connection relay cable (MR-J3BTCBL03M) has a diode built-in. Do not manufacture this cable. This optional cable must be used.

## ● Cables and connectors



Item		Model	Protection level	Description		
Select one of motor power supply cables ⑩ to ⑮ for use	⑭	Power supply connector for HF-SP51, 81, HF-SP52, 102, 152	MR-PWCNS4 (Straight type)	IP67  Motor power supply connector (made by DDK) CE05-6A18-10SD-B-BSS (plug) (straight) CE3057-10A-1 (D265) (cable clamp) <Applicable cable example> Wire size: 2mm <sup>2</sup> (AWG14) to 3.5mm <sup>2</sup> (AWG12) Completed cable outer diameter: φ10.5 to 14.1mm		
	⑮	Power supply connector for HF-SP121, 201, HF-SP202, 352, 502	MR-PWCNS5 (Straight type)	IP67  Motor power supply connector (made by DDK) CE05-6A22-22SD-B-BSS (plug) (straight) CE3057-12A-1 (D265) (cable clamp) <Applicable cable example> Wire size: 5.5mm <sup>2</sup> (AWG10) to 8mm <sup>2</sup> (AWG8) Completed cable outer diameter: φ12.5 to 16mm		
	⑯	Power supply connector for HF-SP702	MR-PWCNS3 (Straight type)	IP67  <Applicable cable example> Wire size: 14mm <sup>2</sup> (AWG6) to 22mm <sup>2</sup> (AWG4) Completed cable outer diameter: φ22 to 23.8mm		
Select one of motor brake cables for use	⑰ 10m or shorter (Direct connection type)	Brake cable for HF-MP/HF-KP series motor Lead out in direction of motor shaft	MR-BKS1CBL□M-A1-H □=cable length 2, 5, 10m (Note 1)	IP65	Motor brake-side connector (made by Japan Aviation Electronics Industry) JN4FT02SJ1 (plug) ST-TMH-S-C1B-100-(A534G) (socket contact)  Lead-out	
		Brake cable for HF-MP/HF-KP series motor Lead out in opposite direction of motor shaft	MR-BKS1CBL□M-A1-L □=cable length 2, 5, 10m (Note 1)	IP65		
	⑱ Exceeding 10m (Relay type)	Brake cable for HF-MP/HF-KP series motor Lead out in direction of motor shaft	MR-BKS1CBL□M-A2-H □=cable length 2, 5, 10m (Note 1)	IP65		
		Brake cable for HF-MP/HF-KP series motor Lead out in opposite direction of motor shaft	MR-BKS1CBL□M-A2-L □=cable length 2, 5, 10m (Note 1)	IP65		
	⑲ Exceeding 10m (Relay type)	Brake cable for HF-MP/HF-KP series motor Lead out in direction of motor shaft	MR-BKS2CBL03M-A1-L Cable length 0.3m (Note 1)	IP55		
		Brake cable for HF-MP/HF-KP series motor Lead out in opposite direction of motor shaft	MR-BKS2CBL03M-A2-L Cable length 0.3m (Note 1)	IP55		
⑳	Brake connector for HF-SP series motor	MR-BKCNS1 (Straight type)	IP67  Motor brake connector (made by DDK) (Soldered type) CM10-SP2S-L (Straight plug) CM10-#22SC (S2) -100 (socket contact) <Applicable cable example> Wire size: 1.25mm <sup>2</sup> (AWG16) or less Completed cable outer diameter: φ9.0 to 11.6mm			
For CNP1, CNP2, CNP3	⑳	Servo amplifier power supply connector set for MR-J3-10B(1) to MR-J3-350B (Note 2)	(Standard accessory: Insertion type)	—  CNP1 connector • For 1kW or less (made by Molex or an equivalent product) 54928-0610 (connector) • For 2, 3.5kW (PHOENIX or an equivalent product) PC4/6-STF-7.62-CRWH (connector) CNP2 connector (made by Molex or an equivalent product) 54927-0510 (connector) CNP3 connector • For 1kW or less (made by Molex or an equivalent product) 54928-0310 (connector) • For 2, 3.5kW (PHOENIX or an equivalent product) PC4/3-STF-7.62-CRWH (connector) Insertion tool (made by Molex or an equivalent product) 54932-0000 <Applicable cable example> (Note 5) • CNP2 connector for 1kW or less, 2 and 3.5kW Wire size: 0.14mm <sup>2</sup> (AWG26) to 2.5mm <sup>2</sup> (AWG14) Completed cable outer diameter: to φ3.8mm <Applicable cable example> (Note 5) • CNP1 and CNP3 connectors for 2 and 3.5kW Wire size: 0.2mm <sup>2</sup> (AWG24) to 5.5mm <sup>2</sup> (AWG10) Completed cable outer diameter: to φ5mm		
For controller, CN1A, CN1B	㉓	SSCNET III cable (Standard cord for inside panel)	MR-J3BUS□M □=cable length 0.15, 0.3, 0.5, 1, 3m	— Connector (made by Japan Aviation Electronics Industry) PF-2D103 (connector)	Connector (made by Japan Aviation Electronics Industry) PF-2D103 (connector)	
	㉔	SSCNET III cable (Standard cable for outside panel)	MR-J3BUS□M-A □=cable length 5, 10, 20m	— 	Note: Look carefully through the precautions enclosed with the options before the use.	
	㉕	SSCNET III cable (Long distance cable) (Note 4)	MR-J3BUS□M-B □=cable length 30, 40, 50m	— Connector (made by Japan Aviation Electronics Industry) CF-2D103-S (connector)		Connector (made by Japan Aviation Electronics Industry) CF-2D103-S (connector)
	㉖	Connector set for SSCNET III	MR-J3BCN1	— 		Connector (made by Japan Aviation Electronics Industry) PF-2D103 (connector)
For CN1B	㉗	Connector cap for SSCNET III	(Standard accessory)	— 		
For CN5	㉘	Personal computer communication cable	USB cable	MR-J3USBCBL3M Cable length 3m	— Amplifier-side connector mini-B connector (5 pins) Personal computer-side connector A connector  Note: This cable cannot be used with the SSCNET III compatible controller.	
For CN3	㉙	Input/output signal connector	MR-CCN1	—  Amplifier-side connector (made by 3M or an equivalent product) 10120-3000VE (connector) 10320-52F0-008 (shell kit) (Note 3)		

Notes: 1. -H and -L indicate a bending life. -H indicates a long bending life, and -L indicates a standard bending life.  
2. The connector type terminal block is available only for the MR-J3-350B or smaller servo amplifier. Refer to the section "Amplifier Dimensions" in this catalog for details.  
3. The connector and the shell kit are soldered type. Models for press bonding type are 10120-6000EL (connector) and 10320-3210-000 (shell kit).  
4. Contact Mitsubishi for details on cables shorter than 30m.  
5. Refer to the section "Peripheral Equipment ● Electrical wires, circuit breakers, magnetic contactors" in this catalog for details on the electrical wire size recommended.

# Ordering Information for Customers

To order the following products, contact the relevant manufacturers directly.

## ● Personal computer communication cables

Item	Model	Protection level	Description
RS-422/RS-232C conversion cable	FA-T-RS40VS	—	 RS-422 cable    RS-422/RS-232C converter    RS-232C cable Manufacturer: MITSUBISHI ELECTRIC ENGINEERING COMPANY LIMITED
	DSV-CABV	—	 Amplifier-side connector    Personal computer-side connector Manufacturer: Diatrend Corp.



## ● RS-422 connector

Item	Model	Protection level	Description
RS-422 connector	TM10P-88P	—	 Manufacturer: HIROSE ELECTRIC CO., LTD.

## ● RS-422 distributor (for multi drop)



Item	Model	Protection level	Description
RS-422 distributor	BMJ-8	—	 Manufacturer: HACHIKO ELECTRIC CO. LTD

## ● Servo amplifier power supply connectors (press bonding type) ... For 1kW or less



Item	Model	Protection level	Description	Applicable cable example
Amplifier-side CNP1 connector	51241-0600 (connector) 56125-0118 (terminal)	—	 Manufacturer: Molex	Wire size: 0.75mm <sup>2</sup> (AWG18) to 2.5mm <sup>2</sup> (AWG14) Completed cable outer diameter: to φ3.8mm Crimping tool (CNP57349-5300) is required.
Amplifier-side CNP2 connector	51240-0500 (connector) 56125-0118 (terminal)	—	 Manufacturer: Molex	
Amplifier-side CNP3 connector	51241-0300 (connector) 56125-0118 (terminal)	—	 Manufacturer: Molex	

## ● Encoder connectors

<For HF-MP/HF-KP series>

Item	Model	Protection level	Description	Applicable cable example
Motor encoder connector	1674320-1	IP65	 Manufacturer: Tyco Electronics AMP K.K.	Wire size: 0.14mm <sup>2</sup> (AWG26) to 0.3mm <sup>2</sup> (AWG22) Completed cable outer diameter: to φ7.1 ± 0.3mm Crimping tools 1596970-1 (for gland clip) and 1596847-1 (for receptacle contact) are required.
Amplifier-side CN2 connector (Note 1)	54593-1011 (connector housing) 54594-1015 (plug cover A) 54595-1005 (plug cover B) 58935-1000 (shell cover) 58934-1000 (shell body) 58937-0000 (cable clamp)	—	 Manufacturer: Molex	

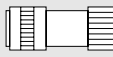
<For HF-SP series>

Item	Connector			Contact	Protection level	Description	Applicable cable example	
	Type	Straight plug	Socket contact				Wire size	Completed cable outer diameter
Motor encoder connector	Straight	CM10-SP10S-M	CM10-#22SC(C1)-100	Press bonding type	IP67	 Manufacturer: DDK Ltd.	0.3mm <sup>2</sup> (AWG22) to 0.5mm <sup>2</sup> (AWG20) Crimping tool (357J-50446) is required.	φ6.0 to 9.0mm
			CM10-#22SC(C2)-100				0.08mm <sup>2</sup> (AWG28) to 0.25mm <sup>2</sup> (AWG23) Crimping tool (357J-50447) is required.	
			CM10-#22SC(S1)-100	Soldered type			0.5mm <sup>2</sup> (AWG20) or less	
Amplifier-side CN2 connector (Note 1)	—	54593-1011 (connector housing) 54594-1015 (plug cover A) 54595-1005 (plug cover B) 58935-1000 (shell cover) 58934-1000 (shell body) 58937-0000 (cable clamp)	—	—	—	 Manufacturer: Molex	—	—

Note: 1. The amplifier-side CN2 connector made by 3M can be used.  
 Model: 36210-0100JL (receptacle), 36310-3200-008 (shell kit).



# Ordering Information for Customers

## ● Motor power supply connectors

### <For HF-MP/HF-KP series>

Item	Model	Protection level	Description	Applicable cable example
Motor power supply-side connector	JN4FT04SJ1 (plug) ST-TMH-S-C1B-100-(A534G) (socket contact)	IP65	 Manufacturer: Japan Aviation Electronics Industry, Ltd.	Wire size: 0.75mm <sup>2</sup> (AWG19) Completed cable outer diameter: $\phi 6.2 \pm 0.3\text{mm}$ Fluoric resin wire (Vinyl jacket cable FV4C <UL Style 2103> (SP3866W-X) made by KURABE INDUSTRIAL CO.,LTD. or equivalent) Crimping tool (CT160-3-TMH5B) is required.

### <For HF-SP series>

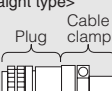
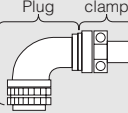
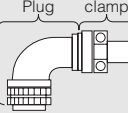
Item	Plug		Cable clamp	Protection level	Description	Applicable cable example	
	Type	Model	Model			Wire size	Completed cable outer diameter
Motor power supply connector for HF-SP51, 81, HF-SP52, 102, 152	Straight	CE05-6A18-10SD-B-BSS	CE3057-10A-2(D265)	IP67 EN standards	<b>&lt;Straight type&gt;</b>  Manufacturer: DDK Ltd.	2mm <sup>2</sup> (AWG14) to 3.5mm <sup>2</sup> (AWG12)	$\phi 8.5$ to 11mm
			CE3057-10A-1(D265)				$\phi 10.5$ to 14.1mm
	Angled	CE05-8A18-10SD-B-BAS	CE3057-10A-2(D265)				$\phi 8.5$ to 11mm
			CE3057-10A-1(D265)				$\phi 10.5$ to 14.1mm
Motor power supply connector for HF-SP121, 201 HF-SP202, 352, 502	Straight	MS3106B18-10S	MS3057-10A	General environment (Note 1)	<b>&lt;Angled type&gt;</b>  Manufacturer: DDK Ltd.	3.5mm <sup>2</sup> (AWG12) to 8mm <sup>2</sup> (AWG8)	$\phi 14.3\text{mm}$ (Inner diameter of bushing)
			Angled				MS3108B18-10S
	CE05-6A22-22SD-B-BSS	CE3057-12A-2(D265)					
	Motor power supply connector for HF-SP702	Straight	CE05-6A32-17SD-B-BSS				CE3057-12A-1(D265)
Angled				CE05-8A22-22SD-B-BAS	CE3057-12A-2(D265)	$\phi 12.5$ to 16mm	
		Straight	MS3106B22-22S		MS3057-12A	$\phi 9.5$ to 13mm	
Angled				MS3108B22-22S	MS3057-12A	$\phi 12.5$ to 16mm	
	Motor power supply connector for HF-SP702	Straight	CE05-6A32-17SD-B-BSS		CE3057-20A-1(D265)	IP67 EN standards	<b>&lt;Angled type&gt;</b>  Manufacturer: DDK Ltd.
Angled				CE05-8A32-17SD-B-BAS	CE3057-20A-1(D265)		
		Straight	MS3106B32-17S		MS3057-20A		
Angled				MS3108B32-17S	MS3057-20A		

Note: 1. Not compliant with EN standards.

## ● Motor brake connectors

### <For HF-MP/HF-KP series>

Item	Model	Protection level	Description	Applicable cable example
Motor brake connector	JN4FT02SJ1 (plug) ST-TMH-S-C1B-100-(A534G) (socket contact)	IP65	 Manufacturer: Japan Aviation Electronics Industry, Ltd.	Wire size: 0.5mm <sup>2</sup> (AWG20) Completed cable outer diameter: $\phi 4.5 \pm 0.3\text{mm}$ Fluoric resin wire (Vinyl jacket cable FV2C <UL Style 2103> (SP3866U-X) made by KURABE INDUSTRIAL CO.,LTD. or equivalent) Crimping tool (CT160-3-TMH5B) is required.

### <For HF-SP series>

Item	Connector			Contact	Protection level	Description	Applicable cable example				
	Type	Straight plug	Socket contact				Wire size	Completed cable outer diameter			
Motor brake connector	Straight	CM10-SP2S-S	CM10-#22SC(S2)-100	Soldered type	IP67	 Manufacturer: DDK Ltd.	1.25mm <sup>2</sup> (AWG16) or less	$\phi 4.0$ to 6.0mm			
		CM10-SP2S-M						$\phi 6.0$ to 9.0mm			
		CM10-SP2S-L						$\phi 9.0$ to 11.6mm			
		CM10-SP2S-S	CM10-#22SC(C3)-100					Press bonding type	IP67	0.5mm <sup>2</sup> (AWG20) to 1.25mm <sup>2</sup> (AWG16) Crimping tool (357J-50448) is required.	$\phi 4.0$ to 6.0mm
		CM10-SP2S-M									$\phi 6.0$ to 9.0mm
		CM10-SP2S-L									$\phi 9.0$ to 11.6mm

# MR-J3 Basic Configuration

Select your system from the items, “Servo amplifiers” and “Servo motors” in the following table.

Item	Configuration	Necessary parts
Servo amplifiers	MR-J3-A type	Refer to parts No. 1 to 2 in the following table “● Servo amplifiers, 1. For MR-J3-A type”.
	MR-J3-B type	Refer to parts No. 1 to 3 in the following table “● Servo amplifiers, 2. For MR-J3-B type”.
Servo motors	HF-MP series Without brake	Refer to parts No. 1 to 3 in the table on the following page “● Servo motors, 3. For HF-MP/HF-KP series”.
	HF-MP series With brake	Refer to parts No. 1 to 4 in the table on the following page “● Servo motors, 3. For HF-MP/HF-KP series”.
	HF-KP series Without brake	Refer to parts No. 1 to 3 in the table on the following page “● Servo motors, 3. For HF-MP/HF-KP series”.
	HF-KP series With brake	Refer to parts No. 1 to 4 in the table on the following page “● Servo motors, 3. For HF-MP/HF-KP series”.
	HF-SP series Without brake	Refer to parts No. 1 to 3 in the table on the following page “● Servo motors, 4. For HF-SP series”.
	HF-SP series With brake	Refer to parts No. 1 to 4 in the table on the following page “● Servo motors, 4. For HF-SP series”.

## ● Servo amplifiers

### 1. For MR-J3-A type

No.	Item	Model
1	Servo amplifier	MR-J3-□A
2	CN1 connector	MR-J3CN1

### 2. For MR-J3-B type

No.	Item	Model	
1	Servo amplifier	MR-J3-□B	
2	SSCNET III cable (between the controller and the servo amplifier): Select one from the following (1) to (3).		
	3m or shorter	(1)	MR-J3BUS□M Refer to item ㉓ on page 30 of this catalog.
	5 to 20m	(2)	MR-J3BUS□M-A Refer to item ㉔ on page 30 of this catalog.
	30 to 50m	(3)	MR-J3BUS□M-B Refer to item ㉕ on page 30 of this catalog.
3	SSCNET III cable (between the servo amplifiers): Select from the following (1) to (3). (No. of axes-1) pcs of cables are required.		
	3m or shorter	(1)	MR-J3BUS□M Refer to item ㉓ on page 30 of this catalog.
	5 to 20m	(2)	MR-J3BUS□M-A Refer to item ㉔ on page 30 of this catalog.
	30 to 50m	(3)	MR-J3BUS□M-B Refer to item ㉕ on page 30 of this catalog.

# MR-J3 Basic Configuration

## ● Servo motors

### 3. For HF-MP/HF-KP series

No.	Item				Model		
1	Servo motor				HF-MP□(B) or HF-KP□(B)		
2	Encoder cable: Select one from the following (1) to (8).						
	10m or shorter (Direct connection type)	IP65	Lead out in direction of motor shaft	Long bending life	(1)	MR-J3ENCBL□M-A1-H	Refer to item ① on page 26 or 29 of this catalog.
				Standard	(2)	MR-J3ENCBL□M-A1-L	
			Lead out in opposite direction of motor shaft	Long bending life	(3)	MR-J3ENCBL□M-A2-H	Refer to item ② on page 26 or 29 of this catalog.
				Standard	(4)	MR-J3ENCBL□M-A2-L	
	Exceeding 10m (Relay type)	IP20	Lead out in direction of motor shaft	Long bending life	(5)	Two types of cables are required. • MR-J3JCBLO3M-A1-L • MR-EKCBL□M-H	Refer to item ③ and ⑤ on page 26 or 29 of this catalog.
				Standard	(6)	Two types of cables are required. • MR-J3JCBLO3M-A1-L • MR-EKCBL□M-L	
			Lead out in opposite direction of motor shaft	Long bending life	(7)	Two types of cables are required. • MR-J3JCBLO3M-A2-L • MR-EKCBL□M-H	Refer to item ④ and ⑤ on page 26 or 29 of this catalog.
Standard				(8)	Two types of cables are required. • MR-J3JCBLO3M-A2-L • MR-EKCBL□M-L		
3	Motor power supply cable: Select one from the following (1) to (6).						
	10m or shorter (Direct connection type)	IP65	Lead out in direction of motor shaft	Long bending life	(1)	MR-PWS1CBL□M-A1-H	Refer to item ⑩ on page 26 or 29 of this catalog.
				Standard	(2)	MR-PWS1CBL□M-A1-L	
			Lead out in opposite direction of motor shaft	Long bending life	(3)	MR-PWS1CBL□M-A2-H	Refer to item ⑪ on page 26 or 29 of this catalog.
				Standard	(4)	MR-PWS1CBL□M-A2-L	
	Exceeding 10m (Relay type)	IP55	Lead out in direction of motor shaft	Standard	(5)	Use a user-manufactured cable connected to MR-PWS2CBL03M-A1-L (optional cable).	Refer to item ⑫ on page 27 or 29 of this catalog.
Lead out in opposite direction of motor shaft			Standard	(6)	Use a user-manufactured cable connected to MR-PWS2CBL03M-A2-L (optional cable).	Refer to item ⑬ on page 27 or 29 of this catalog.	
4	Motor electromagnetic brake cable: Select one from the following (1) to (6).						
	10m or shorter (Direct connection type)	IP65	Lead out in direction of motor shaft	Long bending life	(1)	MR-BKS1CBL□M-A1-H	Refer to item ⑰ on page 27 or 30 of this catalog.
				Standard	(2)	MR-BKS1CBL□M-A1-L	
			Lead out in opposite direction of motor shaft	Long bending life	(3)	MR-BKS1CBL□M-A2-H	Refer to item ⑱ on page 27 or 30 of this catalog.
				Standard	(4)	MR-BKS1CBL□M-A2-L	
	Exceeding 10m (Relay type)	IP55	Lead out in direction of motor shaft	Standard	(5)	Use a user-manufactured cable connected to MR-BKS2CBL03M-A1-L (optional cable).	Refer to item ⑲ on page 27 or 30 of this catalog.
Lead out in opposite direction of motor shaft			Standard	(6)	Use a user-manufactured cable connected to MR-BKS2CBL03M-A2-L (optional cable).	Refer to item ⑳ on page 27 or 30 of this catalog.	

### 4. For HF-SP series

No.	Item				Model	
1	Servo motor				HF-SP□(B)	
2	Encoder cable: Select one from the following (1) to (2).					
	IP67	Long bending life		(1)	MR-J3ENSCBL□M-H	Refer to item ⑦ on page 26 or 29 of this catalog.
Standard		(2)	MR-J3ENSCBL□M-L			
3	Motor power supply cable: Select one from the following (1) to (3).					
	IP67	For HF-SP51,81 HF-SP52, 102, 152		(1)	Manufacture a cable using MR-PWCNS4 (optional connector).	Refer to item ⑭ on page 27 or 30 of this catalog.
		For HF-SP121,201 HF-SP202, 352, 502		(2)	Manufacture a cable using MR-PWCNS5 (optional connector).	Refer to item ⑮ on page 27 or 30 of this catalog.
For HF-SP702		(3)	Manufacture a cable using MR-PWCNS3 (optional connector).	Refer to item ⑯ on page 27 or 30 of this catalog.		
4	Motor electromagnetic brake cable				Manufacture a cable using MR-BKCNS1 (optional connector).	

# Options

## ● Battery (MR-J3BAT)

The servo motor's absolute value can be maintained by installing the battery in the servo amplifier. The battery is not required when the servo system is used in an incremental mode.

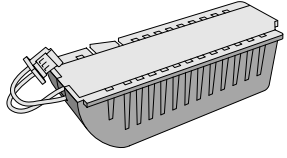
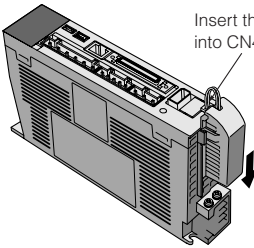
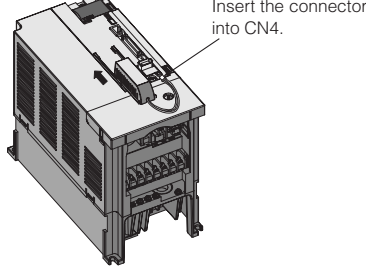
Appearance	Installation method	
 <p>Model: MR-J3BAT Nominal voltage: 3.6V Nominal capacity: 2000mAh Lithium content: 0.65g</p>	<p>&lt;For MR-J3-350A/B or smaller&gt;</p>  <p>Insert the connector into CN4.</p>	<p>&lt;For MR-J3-500A/B or larger&gt;</p>  <p>Insert the connector into CN4.</p>

Note: The 44th Edition of the IATA (International Air Transportation Association) Dangerous Goods Regulations was taken effect on January 1st, 2003 and administered immediately.

In this edition, the provisions relating to lithium and lithium ion batteries have been revised to strengthen regulations on the air transportation of batteries.

This battery is not classified as dangerous goods (not class 9). Therefore, transporting 24 units or less is not subject to the regulations.

However, more than 24 units require packing based on Packing Instruction 903.

For the self-certification form for the battery safety test or more information, contact Mitsubishi.

(as of April, 2005)

## ● Battery connection relay cable (MR-J3BTCBL03M)

Use this relay cable to hold the absolute value if the servo amplifier is removed from the machine for shipping. The servo motor HF series does not have a super capacitor (for holding an absolute value for short time) in the encoder. When this optional cable is used, the absolute value can be held even when the encoder cable is disconnected from the servo amplifier, making it easy to do maintenance on the servo amplifier.

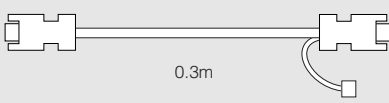
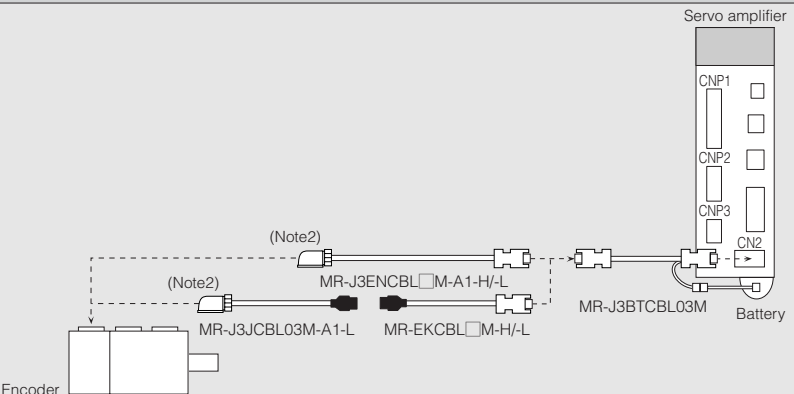
Appearance	Installation method
 <p>0.3m</p>	 <p>Encoder</p> <p>Servo amplifier</p> <p>CNP1</p> <p>CNP2</p> <p>CNP3</p> <p>CN2</p> <p>MR-J3ENCBL□M-A1-H/L</p> <p>MR-J3J3CBL03M-A1-L</p> <p>MR-EKCBL□M-H/L</p> <p>MR-J3BTCBL03M</p> <p>Battery</p> <p>(Note2)</p>

Notes: 1. To hold the absolute value, the encoder, the encoder cable(s), the relay cable and the battery must be kept connected.

2. The encoder cables are led out in the direction of the motor shaft.

Optional cables are also available for leading the cables out in the opposite direction of the motor shaft. Refer to the section "Options ● Cables and connectors" in this catalog.

User's system		Battery (MR-J3BAT)	Battery connection relay cable (MR-J3BTCBL03M)
Incremental	—	Not required	Not required
Absolute	Not necessary to hold an absolute value after the encoder cable is disconnected from the servo amplifier	Required	Not required
	Necessary to hold an absolute value after the encoder cable is disconnected from the servo amplifier (Note)	Required	Required

Note: Start up the absolute system after mounting this optional cable.

## ● Diagnostic cable (MR-J3ACHECK): only for the MR-J3-A type

This cable is required when using the amplifier diagnostic function of MR Configurator (Setup software).

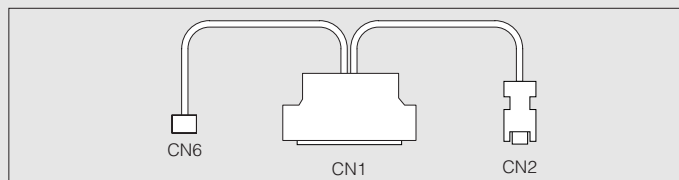

# Using a Personal Computer



## Servo support software

MR Configurator (Setup software) and capacity selection software are available as support software to improve usability.

### ● Compatible personal computer

IBM PC/AT compatible model running with the following operation conditions.

### ● Operation conditions

Software		Capacity selection software MRZJW3-MOTSZ111E (Note 4)	MR Configurator (Setup software) MRZJW3-SETUP2□1E (Note 5)
Personal computer (Note 2)	OS (Note 1)		
	Windows® 95	○	✕
	Windows® 98	○	○ (Note 6)
	Windows® 98 Second Edition	○	○
	Windows® Me	○	○
	Windows NT® Workstation4.0	○	✕
	Windows® 2000 Professional	○	○
	Windows® XP Professional	○	○
Windows® XP Home Edition	○	○	
Processor	Pentium®133MHz or more (Windows® 95, Windows® 98, Windows® 98 Second Edition, Windows NT® Workstation4.0, Windows® 2000 Professional) Pentium®150MHz or more (Windows® Me) Pentium®300MHz or more (Windows® XP Professional, Windows® XP Home Edition)		
Memory	16MB or more (Windows® 95) 24MB or more (Windows® 98, Windows® 98 Second Edition) 32MB or more (Windows® Me, Windows NT® Workstation4.0, Windows® 2000 Professional) 128MB or more (Windows® XP Professional, Windows® XP Home Edition)		
Free hard disk space	40MB or more	130MB or more	
Communication interface	—	Use serial port or USB port	
Monitor	Capable of resolution 800X600 or more, high Color (16-bit display)		
Keyboard	Compatible with above personal computers.		
Mouse	Compatible with above personal computers. Note that serial mice are incompatible.		
Printer	Compatible with above personal computers.		
Communication cable	Not required	MR-J3USBCBL3M	

○ : Available ✕ : Unavailable

## <Capacity selection software>

### ●MRZJW3-MOTSZ111E (Note 4)

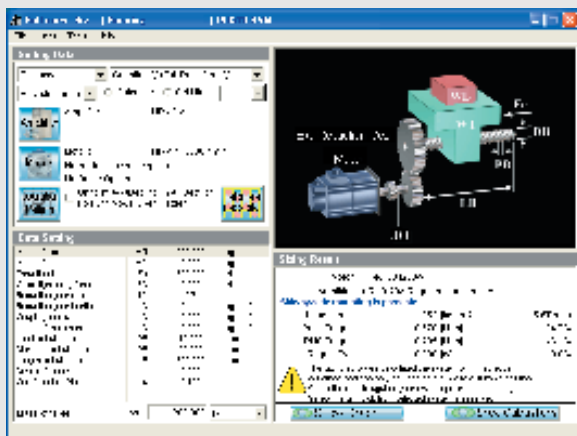

A user-friendly design facilitates selecting the optimum servo amplifier, servo motor (including the servo motor with an electromagnetic brake) and optional regeneration unit just by entering constants and an operation pattern into machine-specific windows.

### Features

- (1) User-defined operation patterns can be set. The operation pattern can be selected from the position control mode operation or speed control mode operation. The selected operation pattern can be also displayed in the graph.
- (2) The feedrate (or motor speed) and torque can be displayed in the graph during the selection process.

### ● Specifications

Item	Description
Types of machine component	Horizontal ball screws, vertical ball screws, rack and pinions, roll feeds, rotating tables, dollies, elevators, conveyors, other (direct inertia input) devices
Output of results	Parameter
	Printing
	Data storage
Inertia moment calculation function	Cylinder, core alignment column, variable speed, linear movement, suspension, conical, truncated cone

Notes:

1. Pentium is registered trademark of Intel Corporation. Windows and Windows NT are registered trademarks of Microsoft Corporation in the United States and other countries.
2. This software may not run correctly, depending on the personal computer being used.
3. The screen shown on this page is for reference and may differ from the actual screen.
4. The MRZJW3-MOTSZ111 software version A3 or above is planned to be compatible with the servo amplifiers, MR-J3-500A or larger, MR-J3-□A1 and MR-J3-B type, and the servo motors, HF-MP, HF-SP1000r/min series and HF-SP502, 702.
5. MRZJW3-SETUP211E is not compatible with the servo amplifiers MR-J3-500A or larger and the MR-J3-B type. Use the MRZJW3-SETUP221E software version B0 or above for these amplifiers.
6. MRZJW3-SETUP221E or above is compatible with Windows®98.

# Using a Personal Computer

## Servo support software

### <MR Configurator>

#### ● MRJW3-SETUP2□1E (Setup software)

This software makes it easy to perform setup, tuning, monitor display, diagnostics, reading and writing of parameters, and test operations with a personal computer. User-satisfying functions that enable the balance with the machine system, optimum control and short setup time are available.

#### ● Features

- (1) This software can easily set up and tune your servo system with a personal computer.
- (2) Multiple monitor functions  
Graphic display functions are provided to display the servo motor status with the input signal triggers, such as the command pulse, droop pulse and speed.
- (3) Test operations with a personal computer  
Test operation of the servo motors can be performed with a personal computer using multiple test mode menus.
- (4) Further advanced tuning is possible with the improved advanced functions.



#### ● Specifications

Main-menu	Functions
Monitors	Batch display, input/output I/F display, high speed monitor, graph display
Alarms	Alarm display, alarm history, display of data that generated alarm
Diagnostics	Failure to rotate reason display, system information display, tuning data display, absolute data display, axis name setting, amplifier diagnostic (Note 2)
Parameters	Parameter setting, device setting, tuning, display of change list, display of detailed information, converter, parameter copy
Test operations	JOG operation, positioning operation, operation without motor, forced digital output, program operation using simple language
Advanced function	Machine analyzer, gain search, machine simulation
Project	Project creation, reading or saving, various data reading, saving or printing
Others	Automatic operation, help display

Notes: 1. The screens shown on this page and the next page are for reference and may differ from the actual screens.

2. The amplifier diagnostic function is available only for the MR-J3-A type. The following versions are compatible with MR-J3-100A or smaller.

- Servo amplifier: Software Version A1 or above
- MR Configurator: MRJW3-SETUP211E Software Version A0 or above

## New functions! Selecting a variety of waveforms now possible !

### [Graph] window

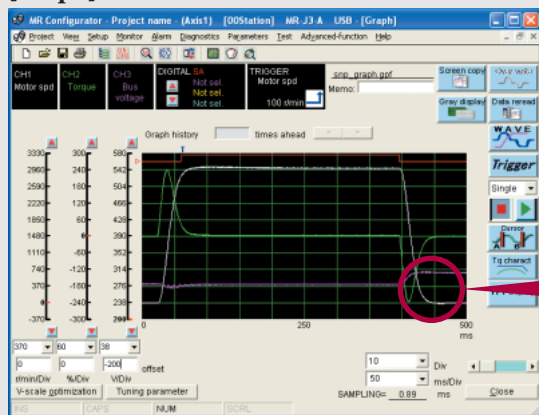

Powerful graph functions with 3 analog channels and 4 digital channels support tuning. User-friendly functions such as [Over write] and [Graph history] and a diverse waveform selection powerfully support user's work. Also, the [Gray display] function is provided for easy reading of printed data. Data can be saved either in CSV or JPEG format.

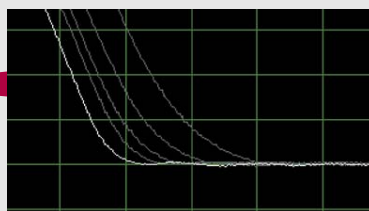

Example of using the [Over write] function in [Graph] window

## New functions!

### Example of using the [Torque characteristic diagram] function in [Graph] window

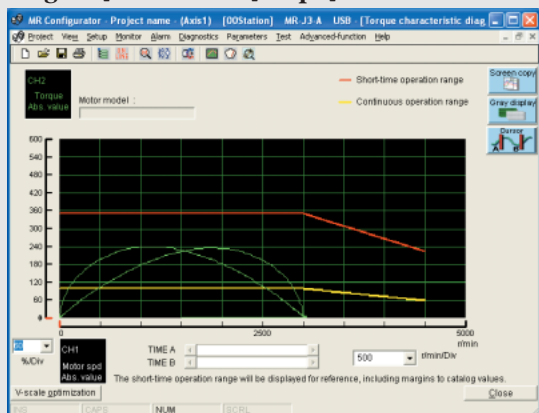

The speed-torque characteristic diagram of the motor in operation can be displayed using the [Torque characteristic diagram] function. Since the actual operation status can be displayed on the servo motor torque characteristics diagram, the status of your servo system can be checked.

# Using a Personal Computer

## Improved accuracy!

### [Machine analyzer operation] window

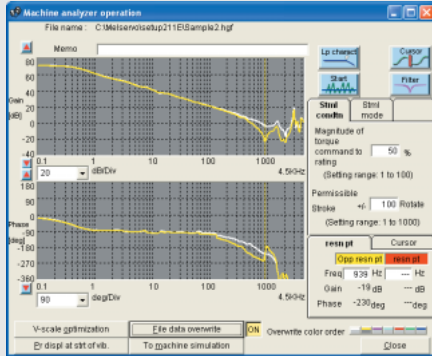

When the [Start] button is pressed, the servo motor is automatically oscillated, and the machine system's frequency characteristics are displayed.

The frequency characteristics that could only be analyzed in a range between 0.1 and 1kHz can now be analyzed in a range between 0.1 and 4.5kHz. Use this also as a tool to comprehend the machine system's characteristics. In addition, data can be overwritten.

## Improved usability!

### [Gain search] window

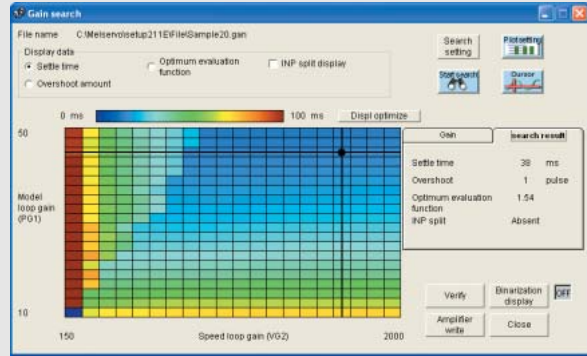

While automatically fluctuating the gain, the setup software "MR Configurator" searches for values with the shortest settling time and lowest overshooting or vibration.

Ever-higher level tuning is now possible.

## Improved usability!

### [Parameter setting] window

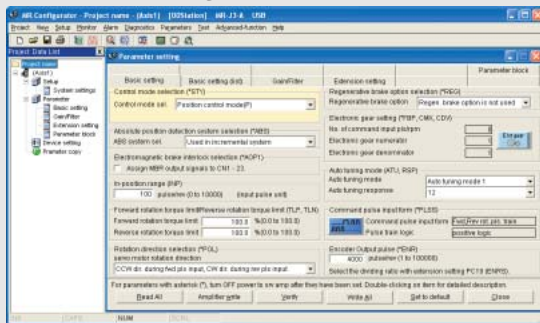

The [Parameter setting] window has been renewed. The basic setting parameters can be easily set in a selection format. Settings in the list format are also possible.

## Improved usability!

### [Monitor] function:

### [Amplifier Data Display] window

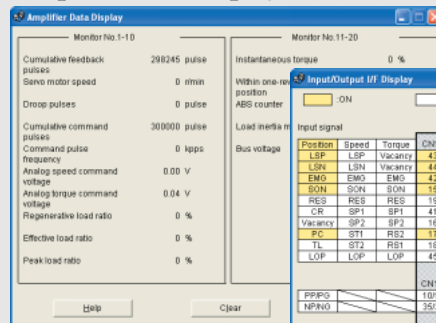

### [Input/Output I/F Display] window

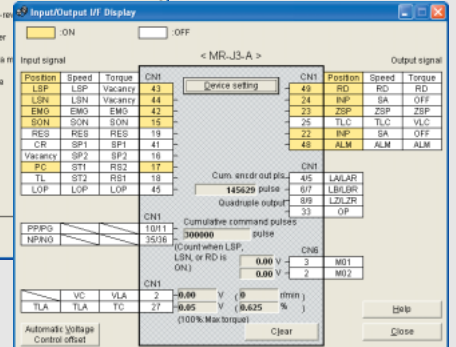

The [Input/Output I/F Display] window has been renewed.

The [Input/Output I/F Display] window and [Amplifier Data Display] window can be displayed simultaneously, so the DI/DO ON/OFF status and operation status can be checked in real time.

## Additional menus further improve usability!

### [Test mode menu] window

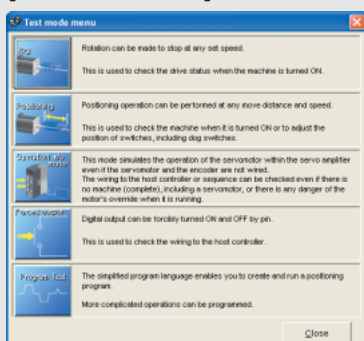

The test operation that matches the application can be selected from the multiple test mode menus.

## New functions!

### [Amplifier diagnostic procedure] window (only for the MR-J3-A type)

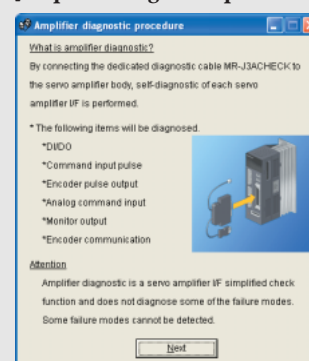

The amplifier diagnostic function has been newly added. The DI/DO signal, command pulse I/F and encoder pulse output are checked. If any fault is found, the amplifier's faulty section is pinpointed to speed up recovery.

The diagnostic cable (MR-J3ACHECK) is required.

# Peripheral Equipment

## ● Power factor improvement reactor (FR-BEL, FR-BAL)

This reactor enables users to boost the servo amplifier's power factor and reduce its power supply capacity. The power factor improvement effect of the DC reactor (FR-BEL) is higher than the AC reactor (FR-BAL), the size is compact and light, and the wiring is easy (The AC reactor uses six wires, and the DC reactor uses two wires). Use of the DC reactor is recommended.

Type	Model	Applicable servo amplifier	Fig.
DC reactor	FR-BEL-0.4K	MR-J3-10A/B MR-J3-20A/B	A
	FR-BEL-0.75K	MR-J3-40A/B	
	FR-BEL-1.5K	MR-J3-60A/B MR-J3-70A/B	
	FR-BEL-2.2K	MR-J3-100A/B	
	FR-BEL-3.7K	MR-J3-200A/B	
	FR-BEL-7.5K	MR-J3-350A/B	
	FR-BEL-11K	MR-J3-500A/B	
	FR-BEL-15K	MR-J3-700A/B	

Type	Model	Applicable servo amplifier	Fig.
AC reactor	FR-BAL-0.4K	MR-J3-10A/B, MR-J3-10A1/B1 MR-J3-20A/B	B
	FR-BAL-0.75K	MR-J3-40A/B MR-J3-20A1/B1	
	FR-BAL-1.5K	MR-J3-60A/B MR-J3-70A/B MR-J3-40A1/B1	
	FR-BAL-2.2K	MR-J3-100A/B	
	FR-BAL-3.7K	MR-J3-200A/B	
	FR-BAL-7.5K	MR-J3-350A/B	
	FR-BAL-11K	MR-J3-500A/B	
	FR-BAL-15K	MR-J3-700A/B	

External dimensions		(Unit: mm)		Connections																																																																																																						
A		<table border="1"> <thead> <tr> <th rowspan="2">Model</th> <th colspan="6">Variable dimensions (mm)</th> <th rowspan="2">Mounting screw size</th> <th rowspan="2">Mass kg (lb)</th> </tr> <tr> <th>A</th> <th>B</th> <th>C</th> <th>D</th> <th>E</th> <th>F × L</th> </tr> </thead> <tbody> <tr> <td>FR-BEL-0.4K</td> <td>110</td> <td>50</td> <td>94</td> <td>1.6</td> <td>95</td> <td>6 × 12</td> <td>M3.5</td> <td>25</td> <td>M5</td> <td>0.5 (1.1)</td> </tr> <tr> <td>FR-BEL-0.75K</td> <td>120</td> <td>53</td> <td>102</td> <td>1.6</td> <td>105</td> <td>6 × 12</td> <td>M4</td> <td>25</td> <td>M5</td> <td>0.7 (1.5)</td> </tr> <tr> <td>FR-BEL-1.5K</td> <td>130</td> <td>65</td> <td>110</td> <td>1.6</td> <td>115</td> <td>6 × 12</td> <td>M4</td> <td>30</td> <td>M5</td> <td>1.1 (2.4)</td> </tr> <tr> <td>FR-BEL-2.2K</td> <td>130</td> <td>65</td> <td>110</td> <td>1.6</td> <td>115</td> <td>6 × 12</td> <td>M4</td> <td>30</td> <td>M5</td> <td>1.2 (2.6)</td> </tr> <tr> <td>FR-BEL-3.7K</td> <td>150</td> <td>75</td> <td>102</td> <td>2.0</td> <td>135</td> <td>6 × 12</td> <td>M4</td> <td>40</td> <td>M5</td> <td>1.7 (3.7)</td> </tr> <tr> <td>FR-BEL-7.5K</td> <td>150</td> <td>75</td> <td>126</td> <td>2.0</td> <td>135</td> <td>6 × 12</td> <td>M5</td> <td>40</td> <td>M5</td> <td>2.3 (5.1)</td> </tr> <tr> <td>FR-BEL-11K</td> <td>170</td> <td>93</td> <td>132</td> <td>2.3</td> <td>155</td> <td>6 × 14</td> <td>M5</td> <td>50</td> <td>M5</td> <td>3.1 (6.8)</td> </tr> <tr> <td>FR-BEL-15K</td> <td>170</td> <td>93</td> <td>170</td> <td>2.3</td> <td>155</td> <td>6 × 14</td> <td>M8</td> <td>56</td> <td>M5</td> <td>3.8 (8.4)</td> </tr> </tbody> </table>	Model	Variable dimensions (mm)						Mounting screw size	Mass kg (lb)	A	B	C	D	E	F × L	FR-BEL-0.4K	110	50	94	1.6	95	6 × 12	M3.5	25	M5	0.5 (1.1)	FR-BEL-0.75K	120	53	102	1.6	105	6 × 12	M4	25	M5	0.7 (1.5)	FR-BEL-1.5K	130	65	110	1.6	115	6 × 12	M4	30	M5	1.1 (2.4)	FR-BEL-2.2K	130	65	110	1.6	115	6 × 12	M4	30	M5	1.2 (2.6)	FR-BEL-3.7K	150	75	102	2.0	135	6 × 12	M4	40	M5	1.7 (3.7)	FR-BEL-7.5K	150	75	126	2.0	135	6 × 12	M5	40	M5	2.3 (5.1)	FR-BEL-11K	170	93	132	2.3	155	6 × 14	M5	50	M5	3.1 (6.8)	FR-BEL-15K	170	93	170	2.3	155	6 × 14	M8	56	M5	3.8 (8.4)	<p>Note: Disconnect the short bar between P1 and P2 when using the DC reactor.</p>
				Model	Variable dimensions (mm)							Mounting screw size	Mass kg (lb)																																																																																													
A	B	C	D		E	F × L																																																																																																				
FR-BEL-0.4K	110	50	94	1.6	95	6 × 12	M3.5	25	M5	0.5 (1.1)																																																																																																
FR-BEL-0.75K	120	53	102	1.6	105	6 × 12	M4	25	M5	0.7 (1.5)																																																																																																
FR-BEL-1.5K	130	65	110	1.6	115	6 × 12	M4	30	M5	1.1 (2.4)																																																																																																
FR-BEL-2.2K	130	65	110	1.6	115	6 × 12	M4	30	M5	1.2 (2.6)																																																																																																
FR-BEL-3.7K	150	75	102	2.0	135	6 × 12	M4	40	M5	1.7 (3.7)																																																																																																
FR-BEL-7.5K	150	75	126	2.0	135	6 × 12	M5	40	M5	2.3 (5.1)																																																																																																
FR-BEL-11K	170	93	132	2.3	155	6 × 14	M5	50	M5	3.1 (6.8)																																																																																																
FR-BEL-15K	170	93	170	2.3	155	6 × 14	M8	56	M5	3.8 (8.4)																																																																																																
B		<table border="1"> <thead> <tr> <th rowspan="2">Model</th> <th colspan="6">Variable dimensions (mm)</th> <th rowspan="2">Mounting screw size</th> <th rowspan="2">Terminal screw size</th> <th rowspan="2">Mass kg (lb)</th> </tr> <tr> <th>W</th> <th>W1</th> <th>H</th> <th>D</th> <th>D1</th> <th>C</th> </tr> </thead> <tbody> <tr> <td>FR-BAL-0.4K</td> <td>135</td> <td>120</td> <td>115</td> <td>59</td> <td>45<sup>0</sup>/<sub>2.5</sub></td> <td>7.5</td> <td>M4</td> <td>M3.5</td> <td>2.0 (4.4)</td> </tr> <tr> <td>FR-BAL-0.75K</td> <td>135</td> <td>120</td> <td>115</td> <td>69</td> <td>57<sup>0</sup>/<sub>2.5</sub></td> <td>7.5</td> <td>M4</td> <td>M3.5</td> <td>2.8 (6.2)</td> </tr> <tr> <td>FR-BAL-1.5K</td> <td>160</td> <td>145</td> <td>140</td> <td>71</td> <td>55<sup>0</sup>/<sub>2.5</sub></td> <td>7.5</td> <td>M4</td> <td>M3.5</td> <td>3.7 (8.2)</td> </tr> <tr> <td>FR-BAL-2.2K</td> <td>160</td> <td>145</td> <td>140</td> <td>91</td> <td>75<sup>0</sup>/<sub>2.5</sub></td> <td>7.5</td> <td>M4</td> <td>M3.5</td> <td>5.6 (12)</td> </tr> <tr> <td>FR-BAL-3.7K</td> <td>220</td> <td>200</td> <td>192</td> <td>90</td> <td>70<sup>0</sup>/<sub>2.5</sub></td> <td>10</td> <td>M5</td> <td>M4</td> <td>8.5 (19)</td> </tr> <tr> <td>FR-BAL-7.5K</td> <td>220</td> <td>200</td> <td>194</td> <td>120</td> <td>100<sup>0</sup>/<sub>2.5</sub></td> <td>10</td> <td>M5</td> <td>M5</td> <td>14.5 (32)</td> </tr> <tr> <td>FR-BAL-11K</td> <td>280</td> <td>255</td> <td>220</td> <td>135</td> <td>100<sup>0</sup>/<sub>2.5</sub></td> <td>12.5</td> <td>M6</td> <td>M6</td> <td>19 (42)</td> </tr> <tr> <td>FR-BAL-15K</td> <td>295</td> <td>270</td> <td>275</td> <td>133</td> <td>110<sup>0</sup>/<sub>2.5</sub></td> <td>12.5</td> <td>M6</td> <td>M6</td> <td>27 (60)</td> </tr> </tbody> </table>	Model	Variable dimensions (mm)						Mounting screw size	Terminal screw size	Mass kg (lb)	W	W1	H	D	D1	C	FR-BAL-0.4K	135	120	115	59	45 <sup>0</sup> / <sub>2.5</sub>	7.5	M4	M3.5	2.0 (4.4)	FR-BAL-0.75K	135	120	115	69	57 <sup>0</sup> / <sub>2.5</sub>	7.5	M4	M3.5	2.8 (6.2)	FR-BAL-1.5K	160	145	140	71	55 <sup>0</sup> / <sub>2.5</sub>	7.5	M4	M3.5	3.7 (8.2)	FR-BAL-2.2K	160	145	140	91	75 <sup>0</sup> / <sub>2.5</sub>	7.5	M4	M3.5	5.6 (12)	FR-BAL-3.7K	220	200	192	90	70 <sup>0</sup> / <sub>2.5</sub>	10	M5	M4	8.5 (19)	FR-BAL-7.5K	220	200	194	120	100 <sup>0</sup> / <sub>2.5</sub>	10	M5	M5	14.5 (32)	FR-BAL-11K	280	255	220	135	100 <sup>0</sup> / <sub>2.5</sub>	12.5	M6	M6	19 (42)	FR-BAL-15K	295	270	275	133	110 <sup>0</sup> / <sub>2.5</sub>	12.5	M6	M6	27 (60)	<p>Servo amplifier 3-phase 200VAC MR-J3-700A/B or smaller</p> <p>Servo amplifier 1-phase 100/200VAC MR-J3-40A1/B1 or smaller or MR-J3-70A/B or smaller</p>							
				Model	Variable dimensions (mm)								Mounting screw size	Terminal screw size	Mass kg (lb)																																																																																											
W	W1	H	D		D1	C																																																																																																				
FR-BAL-0.4K	135	120	115	59	45 <sup>0</sup> / <sub>2.5</sub>	7.5	M4	M3.5	2.0 (4.4)																																																																																																	
FR-BAL-0.75K	135	120	115	69	57 <sup>0</sup> / <sub>2.5</sub>	7.5	M4	M3.5	2.8 (6.2)																																																																																																	
FR-BAL-1.5K	160	145	140	71	55 <sup>0</sup> / <sub>2.5</sub>	7.5	M4	M3.5	3.7 (8.2)																																																																																																	
FR-BAL-2.2K	160	145	140	91	75 <sup>0</sup> / <sub>2.5</sub>	7.5	M4	M3.5	5.6 (12)																																																																																																	
FR-BAL-3.7K	220	200	192	90	70 <sup>0</sup> / <sub>2.5</sub>	10	M5	M4	8.5 (19)																																																																																																	
FR-BAL-7.5K	220	200	194	120	100 <sup>0</sup> / <sub>2.5</sub>	10	M5	M5	14.5 (32)																																																																																																	
FR-BAL-11K	280	255	220	135	100 <sup>0</sup> / <sub>2.5</sub>	12.5	M6	M6	19 (42)																																																																																																	
FR-BAL-15K	295	270	275	133	110 <sup>0</sup> / <sub>2.5</sub>	12.5	M6	M6	27 (60)																																																																																																	



## ● EMC filter

The following filters are recommended as a filter compliant with the EMC directive for the servo amplifier's power supply.

Model	Applicable servo amplifier	Fig.
HF3010A-UN (Note)	MR-J3-10A/B to 100A/B MR-J3-10A1/B1 to 40A1/B1	A
HF3030A-UN (Note)	MR-J3-200A/B MR-J3-350A/B	B
HF3040A-UN (Note)	MR-J3-500A/B MR-J3-700A/B	C

Note: The EMC filters described above are made by SOSHIN ELECTRIC CO.

	External dimensions (Unit: mm)	Connections																																							
A	<p>● HF3010A-UN</p> <table border="1" style="margin-left: auto; margin-right: auto;"> <thead> <tr> <th>Model</th> <th>Mass kg (lb)</th> </tr> </thead> <tbody> <tr> <td>HF3010A-UN</td> <td>3 (6.6)</td> </tr> </tbody> </table> <p>Note: A surge protector is separately required to use this EMC filter. Refer to "EMC Installation Guidelines".</p>	Model	Mass kg (lb)	HF3010A-UN	3 (6.6)	<p>Note: Servo amplifier MR-J3-350A/B or smaller MR-J3-40A1/B1 or smaller</p> <p>(Note) Power supply 3-phase 200 to 230VAC or 1-phase 200 to 230VAC</p> <p>Note: When using a power supply, 1-phase 200 to 230VAC, connect the power supply to the L1 and L2 terminals. Do not connect anything to L3. 1-phase 200 to 230VAC is available only for the MR-J3-70□ or smaller servo amplifier. There is no L3 for 1-phase 100 to 120VAC power supply.</p>																																			
Model	Mass kg (lb)																																								
HF3010A-UN	3 (6.6)																																								
B	<p>● HF3030A-UN</p> <table border="1" style="margin-left: auto; margin-right: auto;"> <thead> <tr> <th rowspan="2">Model</th> <th colspan="11">Variable dimensions (mm)</th> <th rowspan="2">Mass kg (lb)</th> </tr> <tr> <th>A</th> <th>B</th> <th>C</th> <th>D</th> <th>E</th> <th>F</th> <th>G</th> <th>H</th> <th>J</th> <th>K</th> <th>L</th> <th>M</th> </tr> </thead> <tbody> <tr> <td>HF3030A-UN</td> <td>260</td> <td>210</td> <td>85</td> <td>155</td> <td>140</td> <td>125</td> <td>44</td> <td>140</td> <td>70</td> <td>R3.25 Length 8</td> <td>M5</td> <td>M4</td> <td>5.5 (12)</td> </tr> </tbody> </table> <p>Note: A surge protector is separately required to use this EMC filter. Refer to "EMC Installation Guidelines".</p>	Model	Variable dimensions (mm)											Mass kg (lb)	A	B	C	D	E	F	G	H	J	K	L	M	HF3030A-UN	260	210	85	155	140	125	44	140	70	R3.25 Length 8	M5	M4	5.5 (12)	<p>Note: Servo amplifier MR-J3-500A/B MR-J3-700A/B</p> <p>(Note) Power supply 3-phase 200 to 230VAC</p> <p>Note: When using a power supply, 1-phase 200 to 230VAC, connect the power supply to the L1 and L2 terminals. Do not connect anything to L3. 1-phase 200 to 230VAC is available only for the MR-J3-70□ or smaller servo amplifier. There is no L3 for 1-phase 100 to 120VAC power supply.</p>
Model	Variable dimensions (mm)											Mass kg (lb)																													
	A	B	C	D	E	F	G	H	J	K	L		M																												
HF3030A-UN	260	210	85	155	140	125	44	140	70	R3.25 Length 8	M5	M4	5.5 (12)																												
C	<p>● HF3040A-UN</p> <table border="1" style="margin-left: auto; margin-right: auto;"> <thead> <tr> <th rowspan="2">Model</th> <th colspan="11">Variable dimensions (mm)</th> <th rowspan="2">Mass kg (lb)</th> </tr> <tr> <th>A</th> <th>B</th> <th>C</th> <th>D</th> <th>E</th> <th>F</th> <th>G</th> <th>H</th> <th>J</th> <th>K</th> <th>L</th> <th>M</th> </tr> </thead> <tbody> <tr> <td>HF3040A-UN</td> <td>260</td> <td>210</td> <td>85</td> <td>155</td> <td>140</td> <td>125</td> <td>44</td> <td>140</td> <td>70</td> <td>R3.25 Length 8</td> <td>M5</td> <td>M4</td> <td>6.0 (13)</td> </tr> </tbody> </table> <p>Note: A surge protector is separately required to use this EMC filter. Refer to "EMC Installation Guidelines".</p>	Model	Variable dimensions (mm)											Mass kg (lb)	A	B	C	D	E	F	G	H	J	K	L	M	HF3040A-UN	260	210	85	155	140	125	44	140	70	R3.25 Length 8	M5	M4	6.0 (13)	<p>Note: Servo amplifier MR-J3-500A/B MR-J3-700A/B</p> <p>(Note) Power supply 3-phase 200 to 230VAC</p> <p>Note: When using a power supply, 1-phase 200 to 230VAC, connect the power supply to the L1 and L2 terminals. Do not connect anything to L3. 1-phase 200 to 230VAC is available only for the MR-J3-70□ or smaller servo amplifier. There is no L3 for 1-phase 100 to 120VAC power supply.</p>
Model	Variable dimensions (mm)											Mass kg (lb)																													
	A	B	C	D	E	F	G	H	J	K	L		M																												
HF3040A-UN	260	210	85	155	140	125	44	140	70	R3.25 Length 8	M5	M4	6.0 (13)																												

# Peripheral Equipment

## ● Electrical wires, circuit breakers, magnetic contactors

Servo amplifier	Circuit breaker	Magnetic contactor	Electrical wire size (mm <sup>2</sup> ) (Note 1)				
			L1, L2, L3, P1, P2, ⊕ (Note 2)	L11, L21	U, V, W, ⊕	P, C (Note 2)	B1, B2
MR-J3-10A(1)/B(1) MR-J3-20A/B	30A frame 5A	S-N10	2 (AWG14)	1.25 (AWG16)	1.25 (AWG16) (Note 3)	2 (AWG14)	1.25 (AWG16) (Note 4)
MR-J3-40A/B MR-J3-20A1/B1	30A frame 10A						
MR-J3-60A/B MR-J3-40A1/B1 MR-J3-70A/B	30A frame 15A						
MR-J3-100A/B	30A frame 20A						
MR-J3-200A/B	30A frame 20A	S-N18	3.5 (AWG12)				
MR-J3-350A/B	30A frame 30A	S-N20	5.5 (AWG10)				
MR-J3-500A/B	50A frame 50A	S-N35					
MR-J3-700A/B	100A frame 75A	S-N50	8 (AWG8)			3.5 (AWG12)	

- Notes: 1. The wires in the above table are assumed to use 600V polyvinyl chloride electrical wire having a length of 30m. Use a wire with the above size or larger.  
 2. Connect a reactor or an optional regeneration unit using the 5m or shorter length electrical wire.  
 3. Use a fluoric resin wire (0.75mm<sup>2</sup> (AWG19)) when connecting with the HF-MP/HF-KP series motor power supply connector. Refer to "SERVO AMPLIFIER INSTRUCTION MANUAL" for details on wiring cables.  
 4. Use a fluoric resin wire (0.5mm<sup>2</sup> (AWG20)) when connecting with the HF-MP/HF-KP series motor electromagnetic brake connector. Refer to "SERVO AMPLIFIER INSTRUCTION MANUAL" for details on wiring cables.

## ● Surge suppressor

Attach surge suppressors to the servo amplifier, signal cable's AC relays, AC valves, and AC electromagnetic brake. Attach diodes to DC relays and DC valves.

Sample configuration

Surge suppressor: 972A-2003 504 11 (rated 200VAC, made by Matsuo Denki)

Diode : A diode with resisting pressure 4 or more times greater than the relay's drive voltage, and 2 or more times greater than the current.

## ● Data line filter

Attaching a data line filter to the pulse output cable or motor encoder cable of the pulse train output controller (QD75D, etc.) is effective in preventing noise penetration.

Sample configuration

Data line filter: ESD-SR-25 (made by NEC TOKIN), ZCAT3035-1330 (made by TDK)

## ● Radio noise filter (FR-BIF)

This filter effectively controls noise emitted from the power supply side of the servo amplifier, and is especially effective for radio frequency bands 10MHz or lower. Available only for input.

External dimensions (Unit: mm)	Connections
	<p>Notes:            1. Cannot be connected to output side of the servo amplifier.            2. Wiring should be as short as possible.            3. Be sure to insulate the unused wire when using FR-BIF with the 1-phase wire.</p>

## ● Line noise filter (FR-BSF01, FR-BLF)

This filter is effective in suppressing radio noise emitted from the servo amplifier's power supply side or output side, and high-frequency leakage current (zero-phase current). Especially effective in the 0.5 to 5MHz band.

External dimensions (Unit: mm)	Connections
<div style="display: flex; justify-content: space-around;"> <div style="text-align: center;"> <p>&lt;FR-BSF01&gt; MR-J3-200A/B or smaller</p> </div> <div style="text-align: center;"> <p>&lt;FR-BLF&gt; MR-J3-350A/B or larger</p> </div> </div>	<p>Wind 3-phase wires an equal number of times in the same direction and connect them to the power supply side and output side of the servo amplifier. The effect of the filter on the power supply side rises as the number of winds increases, but generally wind the wires four times each. If the wire is thick and hard to wind, use two or more filters, and make sure that the total number of turns exceeds the above number. Make sure that the number of turns on the output side is four times or less. Do not wind the grounding (earth) wire together with the 3-phase wires. The effect of the filter will drop.</p>

# Cautions Concerning Use

## To ensure safe use

- To use the products given in this catalog properly, always read the “Installation Guide” and “MR-J3 INSTRUCTION MANUAL” before starting to use them.
- These products have been manufactured as a general-purpose part for general industries, and have not been designed or manufactured to be incorporated in a device or system used in purposes related to human life.
- Before using the products for special purposes such as nuclear power, electric power, aerospace, medicine, passenger movement vehicles or underwater relays, contact Mitsubishi.
- These products have been manufactured under strict quality control. However, when installing the product where major accidents or losses could occur if the product fails, install appropriate backup or failsafe functions in the system.

## Cautions concerning use

### Transport and installation of motor

- Protect the motor or encoder from impact during handling. When installing a pulley or coupling, do not hammer on the shaft. Impact can damage the encoder. In the case of the motor with a key, install a pulley or coupling with the screw of shaft-end. Use a pulley extractor when taking off the pulley.



- Do not apply a load exceeding the tolerable load onto the servo motor shaft. The shaft could break.

### Installation

- Avoid installation in an environment in which oil mist, dust, etc. are in the air. When using in such an environment, enclose the servo amplifier in a sealed panel. Protect the motor by furnishing a cover for it or taking similar measures.
- Mount the amplifier vertically on a wall.
- When installing several amplifiers in a row in a sealed panel, leave 10mm or more open between each amplifier. The MR-J3-350□ or smaller servo amplifier can be installed closely. In this case, keep the ambient temperature within 0 to 45°C (32 to 113°F), or use them with 75% or less of the effective load rate.

When using one amplifier, always leave 40mm or more open in the upward and downward directions.

To ensure the life and reliability, keep space as open as possible toward the top plate so that heat does not build up. Take special care, especially when installing several amplifiers in a row.

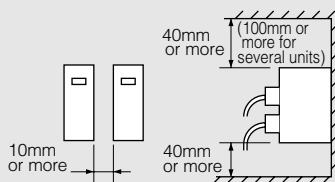

- For a single motor, the motor can be mounted horizontally or vertically. When mounting vertically (shaft-up), take measures on the machine side to ensure that oil from the gear

box does not get into the motor.

- Do not touch the servo motor during or after operation until it has had sufficient time to cool. The motor could be very hot, and severe burns may result from touching the motor.
- The optional regeneration unit becomes hot (the temperature could be 100°C(212°F) or more) with frequent use. Do not install within flammable objects or objects subject to thermal deformation. Take care to ensure that electrical wires do not come into contact with the main unit.
- Carefully consider the cable clamping method, and make sure that bending stress and the stress of the cable's own weight are not applied on the cable connection section.
- If using in an application where the servo motor moves, select the cable bending radius according to the required bending life and wire type.

### Grounding

- Securely ground to prevent electric shocks and to stabilize the potential in the control circuit.
- To ground the servo motor and servo amplifier at one point, connect the grounding terminals of each unit, and ground from the servo amplifier side.
- Faults such as a deviation in position could occur if the grounding is insufficient.

### Wiring

- When a commercial power supply is applied to the amplifier's output terminals (U, V, W), the amplifier will be damaged. Before switching the power on, perform thorough wiring and sequence checks to ensure that there are no wiring errors, etc.
- When a commercial power supply is applied to the motor's input terminals (U, V, W), the motor will be damaged. Connect the motor to the amplifier's output terminals (U, V, W).
- Match the phase of the motor's input terminals (U, V, W) to the amplifier's output terminals (U, V, W) before connecting. If they are not the same, the motor control cannot be performed.
- Validate the stroke end signals (LSP, LSN) in the position control or speed control mode. The motor will not start if the signals are invalid.
- Do not apply excessive tension on the fiber-optic cable when cabling.
- The minimum bending radius of the fiber-optic cable is 25mm for MR-J3BUS□M and 50mm for MR-J3BUS□M-A/-B. Using the cable under the minimum bending radius cannot be guaranteed.
- If the ends of the fiber-optic cable are dirty, the light will be obstructed, resulting malfunctions. Always clean the ends if dirty.
- Do not tighten the fiber-optic cable with a nylon band (ty rap), etc.
- Do not directly look at the light when the fiber-optic cable is not connected.

# Cautions Concerning Use

## Factory settings

- All available motor and amplifier combinations are predetermined. Confirm the models of the motor and amplifier to be used before installation.
- For the MR-J3-A type, use the parameter No.PA01 for the control mode to set position, speed and torque. The default value is set to position, so when using the speed operation, change the setting value.  
For the MR-J3-B type, the control mode is selected by the controller.
- When using the optional regeneration unit, change the parameter No.PA02 (for the MR-J3-A or MR-J3-B type). The optional regeneration unit is disabled as the default, so the parameter must be changed to increase the regeneration performance.

## Operation

- When a magnetic contactor (MC) is installed on the amplifier's primary side, do not perform frequent starts and stops with the MC. Doing so could cause the amplifier to fail.
- When a trouble occurs, the amplifier's safety features are activated, halting output, and the dynamic brake instantly stops the motor. If free run is required, contact Mitsubishi about solutions involving servo amplifiers where the dynamic brake is not activated.
- When using a motor with an electromagnetic brake, do not apply the brake when the servo is on. Doing so could cause an amplifier overload or shorten brake life. Apply the brake when the servo is off.

## Precautions for Choosing the Products

- Mitsubishi will not be held liable for damage caused by factors found not to be the cause of Mitsubishi; opportunity loss or lost profits caused by faults in the Mitsubishi products; damage, secondary damage, accident compensation caused by special factors unpredictable by Mitsubishi; damages to products other than Mitsubishi products; and to other duties.

## Cautions concerning model selection

- Select a motor with a rated torque above the continuous effective load torque.
- Design the operation pattern in the command section so that positioning can be completed, taking the stop setting time ( $t_s$ ) into account.

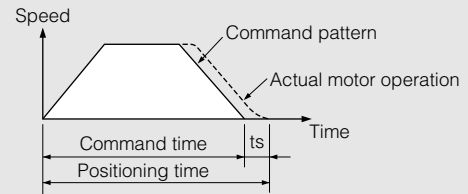

- The load inertia moment should be below the recommended load inertia moment ratio of the motor being used. If it is too large, desired performance may not be attainable.





 **Safety Warning**

To ensure proper use of the products listed in this catalog,  
please be sure to read the instruction manual prior to use.

 **MITSUBISHI ELECTRIC CORPORATION**  
HEAD OFFICE: MITSUBISHI DENKI BLDG., 2-2-3, MARUNOUCHI, CHIYODA-KU, TOKYO 100-8310, JAPAN