

MITSUBISHI



GRAPHIC OPERATION TERMINAL

GOT1000

GT14 User's Manual



● SAFETY PRECAUTIONS ●

(Always read these precautions before using this equipment.)

Before using this product, please read this manual and the relevant manuals introduced in this manual carefully and pay full attention to safety to handle the product correctly.

The precautions given in this manual are concerned with this product.

In this manual, the safety precautions are ranked as "DANGER" and "CAUTION".



DANGER

Indicates that incorrect handling may cause hazardous conditions, resulting in death or severe injury.



CAUTION

Indicates that incorrect handling may cause hazardous conditions, resulting in medium or slight personal injury or physical damage.

Note that the  caution level may lead to a serious accident according to the circumstances.

Always follow the instructions of both levels because they are important to personal safety.

Please save this manual to make it accessible when required and always forward it to the end user.

[DESIGN PRECAUTIONS]

DANGER

- Some failures of the GOT, communication unit or cable may keep the outputs on or off.
An external monitoring circuit should be provided to check for output signals which may lead to a serious accident.
Not doing so can cause an accident due to false output or malfunction.
- If a communication fault (including cable disconnection) occurs during monitoring on the GOT, communication between the GOT and PLC CPU is suspended and the GOT becomes inoperative.
A system where the GOT is used should be configured to perform any significant operation to the system by using the switches of a device other than the GOT on the assumption that a GOT communication fault will occur.
Not doing so can cause an accident due to false output or malfunction.
- Do not use the GOT as the warning device that may cause a serious accident.
An independent and redundant hardware or mechanical interlock is required to configure the device that displays and outputs serious warning.
Failure to observe this instruction may result in an accident due to incorrect output or malfunction.
- Incorrect operation of the touch switch(s) may lead to a serious accident if the GOT backlight is gone out.
When the GOT backlight goes out, the POWER LED blinks (green/orange) and the display section dims, while the input of the touch switch(s) remains active.
This may confuse an operator in thinking that the GOT is in "screensaver" mode, who then tries to release the GOT from this mode by touching the display section, which may cause a touch switch to operate.
Note that the following occurs on the GOT when the backlight goes out.
 - The POWER LED flickers (green/orange) and the monitor screen appears blank.

[DESIGN PRECAUTIONS]

DANGER

- The display section is an analog-resistive type touch panel.
If you touch the display section simultaneously in 2 points or more, the switch that is located around the center of the touched point, if any, may operate.
Do not touch the display section in 2 points or more simultaneously.
Doing so may cause an accident due to incorrect output or malfunction.
- When programs or parameters of the controller (such as a PLC) that is monitored by the GOT are changed, be sure to reset the GOT or shut off the power of the GOT at the same time.
Not doing so can cause an accident due to false output or malfunction.

CAUTION

- Do not bundle the control and communication cables with main-circuit, power or other wiring.
Run the above cables separately from such wiring and keep them a minimum of 100mm apart.
Not doing so noise can cause a malfunction.
- Do not press the GOT display section with a pointed material as a pen or driver.
Doing so can result in a damage or failure of the display section.
- When the GOT is connected to the Ethernet network, the available IP address is restricted according to the system configuration.
 - When multiple GOTs are connected to the Ethernet network:
Do not set the IP address (192.168.0.18) for the GOTs and the controllers in the network.
 - When a single GOT is connected to the Ethernet network:
Do not set the IP address (192.168.0.18) for the controllers except the GOT in the network.
Doing so can cause the IP address duplication. The duplication can negatively affect the communication of the device with the IP address (192.168.0.18).
The operation at the IP address duplication depends on the devices and the system.
- Turn on the controllers and the network devices to be ready for communication before they communicate with GOT.
Failure to do so can cause a communication error on the GOT.

[MOUNTING PRECAUTIONS]

DANGER

- Be sure to shut off all phases of the external power supply used by the system before mounting or removing the GOT to/from the panel.
Not switching the power off in all phases can cause a unit failure or malfunction.

[MOUNTING PRECAUTIONS]

CAUTION

- Use the GOT in the environment that satisfies the general specifications described in the User's Manual.
Not doing so can cause an electric shock, fire, malfunction or product damage or deterioration.
- When mounting the GOT to the panel, tighten the mounting screws within the specified torque range. Undertightening can cause the GOT to drop, short or malfunction. Also, undertightening can disable waterproof or oil proof effect.
Overtightening can cause a drop, short circuit or malfunction due to the damage of the screws or the GOT.
Also, "distortion" of the GOT or the panel may disable waterproof or oil proof effect.
- Never drop cutting chips and electric wire chips into the ventilation window of the GOT when you drill screw holes or perform wiring.
Otherwise, fire, failure or malfunction may be caused.
- When inserting/removing a SD card into/from the GOT, turn the SD card access switch off in advance.
Failure to do so may corrupt data within the SD card.
- When removing a SD card from the GOT, make sure to support the SD card by hand, as it may pop out.
Failure to do so may cause the SD card to drop from the GOT and break.
- When installing a USB memory to the GOT, make sure to install the USB memory to the USB interface firmly.
Failure to do so may cause a malfunction due to poor contact.
- Before removing the USB memory from the GOT, operate the utility screen for removal.
After the successful completion dialog box is displayed, remove the memory by hand carefully.
Failure to do so may cause the USB memory to drop, resulting in a damage or failure of the memory.
- Operate and store the GOT in environments without direct sunlight, high temperature, dust, humidity, and vibrations.
- When using the GOT in the environment of oil or chemicals, use the protective cover for oil.
Failure to do so may cause failure or malfunction due to the oil or chemical entering into the GOT.

[WIRING PRECAUTIONS]

DANGER

- Be sure to shut off all phases of the external power supply used by the system before wiring. Failure to do so may result in an electric shock, product damage or malfunctions.
- Always ground the FG terminal of the GOT power to the protective ground conductors dedicated to the GOT.
Not doing so may cause an electric shock or malfunction.
- Correctly wire the GOT power supply section after confirming the rated voltage and terminal arrangement of the product.
Not doing so can cause a fire or failure.
- Tighten the terminal screws of the GOT power supply section in the specified torque range. Undertightening can cause a short circuit or malfunction.
Overtightening can cause a short circuit or malfunction due to the damage of the screws or the GOT.
- Exercise care to avoid foreign matter such as chips and wire offcuts entering the GOT.
Not doing so can cause a fire, failure or malfunction.

CAUTION

- The cables connected to the unit must be run in ducts or clamped.
Not doing so can cause the unit or cable to be damaged due to the dangling, motion or accidental pulling of the cables or can cause a malfunction due to a cable connection fault.
- When unplugging the cable connected to the unit, do not hold and pull the cable portion.
Doing so can cause the unit or cable to be damaged or can cause a malfunction due to a cable connection fault.
- Plug the communication cable into the connector of the connected unit and tighten the mounting and terminal screws in the specified torque range.
Undertightening can cause a short circuit or malfunction. Overtightening can cause a short circuit or malfunction due to the damage of the screws or unit.

[TEST OPERATION PRECAUTIONS]

DANGER

- Before performing the test operations of the user creation monitor screen (such as turning ON or OFF bit device, changing the word device current value, changing the settings or current values of the timer or counter, and changing the buffer memory current value), read through the manual carefully and make yourself familiar with the operation method.
During test operation, never change the data of the devices which are used to perform significant operation for the system.
False output or malfunction can cause an accident.

[STARTUP/MAINTENANCE PRECAUTIONS]

DANGER

- When power is on, do not touch the terminals.
Doing so can cause an electric shock or malfunction.
- Correctly connect the battery connector.
Do not charge, disassemble, heat, short-circuit, solder, or throw the battery into the fire.
Doing so will cause the battery to produce heat, explode, or ignite, resulting in injury and fire.
- Before starting cleaning or terminal screw retightening, always switch off the power externally in all phases.
Not switching the power off in all phases can cause a unit failure or malfunction.
Undertightening can cause a short circuit or malfunction.
Overtightening can cause a short circuit or malfunction due to the damage of the screws or unit.

CAUTION

- Do not disassemble or modify the unit.
Doing so can cause a failure, malfunction, injury or fire.
- Do not touch the conductive and electronic parts of the unit directly.
Doing so can cause a unit malfunction or failure.
- Do not drop or apply strong impact to the unit.
Doing so may damage the unit.
- Do not drop or give an impact to the battery mounted to the unit.
Doing so may damage the battery, causing the battery fluid to leak inside the battery.
If the battery is dropped or given an impact, dispose of it without using.
- For repair of the backlight, contact your local Mitsubishi (Electric System) Service.
- Before touching the unit, always touch grounded metal, etc. to discharge static electricity from human body, etc.
Not doing so can cause the unit to fail or malfunction.
- Replace battery with GT11-50BAT by Mitsubishi electric Co. only.
Use of another battery may present a risk of fire or explosion.
- Dispose of used battery promptly.
Keep away from children. Do not disassemble and do not dispose of in fire.

[DISPOSAL PRECAUTIONS]

CAUTION

- When disposing of the product, handle it as industrial waste.
- When disposing of this product, treat it as industrial waste. When disposing of batteries, separate them from other wastes according to the local regulations.
(For details of the battery directive in EU member states, refer to the User's Manual of the GOT to be used.)

[TOUCH PANEL PRECAUTIONS]

CAUTION

- For the analog-resistive film type touch panels, normally the adjustment is not required. However, the difference between a touched position and the object position may occur as the period of use elapses. When any difference between a touched position and the object position occurs, execute the touch panel calibration.
- When any difference between a touched position and the object position occurs, other object may be activated. This may cause an unexpected operation due to incorrect output or malfunction.

[TRANSPORTATION PRECAUTIONS]

CAUTION

- When transporting lithium batteries, make sure to treat them based on the transport regulations.
(For details on models subject to restrictions, refer to the User's Manual for the GOT you are using.)
- Before transporting the GOT, turn the GOT power on and check that the battery voltage status is normal on the Time setting & display screen (utilities screen). In addition, confirm that the adequate battery life remains on the rating plate.
Transporting the GOT with the low battery voltage or the battery the reached battery life may unstabilize the backup data unstable during transportation.
- Make sure to transport the GOT main unit and/or relevant unit(s) in the manner they will not be exposed to the impact exceeding the impact resistance described in the general specifications of the User's Manual, as they are precision devices.
Failure to do so may cause the unit to fail.
Check if the unit operates correctly after transportation.

INTRODUCTION

Thank you for choosing Mitsubishi Graphic Operation Terminal (Mitsubishi GOT).

Read this manual and make sure you understand the functions and performance of the GOT thoroughly in advance to ensure correct use.

CONTENTS

SAFETY PRECAUTIONS	A - 1
INTRODUCTION	A - 7
CONTENTS	A - 7
MANUALS.....	A - 13
QUICK REFERENCE	A - 13
ABBREVIATIONS AND GENERIC TERMS	A - 15
HOW TO READ THIS MANUAL	A - 20

1. OVERVIEW

1.1 Features.....	1 - 2
1.1.1 Rough procedure.....	1 - 3

2. SYSTEM CONFIGURATION

2.1 Overall Configuration	2 - 1
2.2 System Equipment.....	2 - 1
2.2.1 GOT (GT14)	2 - 2
2.2.2 Option	2 - 3

3. SPECIFICATIONS

3.1 General Specifications.....	3 - 1
3.2 Performance Specifications	3 - 2
3.3 Power Supply Specifications	3 - 3

4. PARTS NAME

4.1 Front Panel	4 - 1
4.2 Back Panel.....	4 - 2
4.3 Rear Face.....	4 - 3

5. UL, cUL STANDARDS AND EMC DIRECTIVE

5.1 UL, cUL Standards	5 - 1
5.2 EMC Directive	5 - 1
5.2.1 Requirements to Meet EMC Directive	5 - 2
5.2.2 EMC Directive-Compliant System Configuration	5 - 4
5.2.3 Precautions for Wiring/Connecting the EMC Directive-Compliant Product	5 - 5

6. INSTALLATION

6.1	Control Panel Inside Dimensions for Mounting GOT	6 - 1
6.2	Panel Cutting Dimension	6 - 2
6.3	Mounting Position	6 - 2
6.4	Control Panel Temperature and Mounting Angle	6 - 3
6.5	Installation Procedure	6 - 4

7. WIRING

7.1	Power Supply Wiring	7 - 2
7.1.1	Wiring example	7 - 2
7.1.2	Grounding the GOT	7 - 2
7.1.3	The cause of malfunctions related wiring/Remedy	7 - 3
7.2	Wiring inside and outside the panel	7 - 5
7.2.1	Wiring inside	7 - 5
7.2.2	Outside the panel.....	7 - 5
7.2.3	Attaching surge killers to control equipment	7 - 6

8. OPTION

8.1	SD Card	8 - 1
8.1.1	Applicable SD card	8 - 1
8.1.2	Installing and removing procedures of the SD card	8 - 1
8.2	USB Memory	8 - 3
8.2.1	Applicable USB memory	8 - 3
8.2.2	Installing and removing procedures of the USB memory	8 - 3
8.3	Battery	8 - 4
8.3.1	Applicable battery	8 - 4
8.3.2	Battery specifications.....	8 - 4
8.3.3	Battery replacement procedure	8 - 5
8.4	Protective Sheet	8 - 6
8.4.1	Applicable protective sheet.....	8 - 6
8.4.2	Installing procedure	8 - 6
8.5	Protective Cover for Oil.....	8 - 7
8.5.1	Applicable protective cover for oil	8 - 7
8.5.2	Installing procedure	8 - 7
8.6	USB Environmental Protection Cover.....	8 - 9
8.6.1	Applicable USB environmental protection cover.....	8 - 9
8.6.2	Installing procedure	8 - 9
8.7	Stand	8 - 10
8.7.1	Applicable stand	8 - 10
8.7.2	Installing procedure	8 - 10
8.8	Connector Conversion Adapter	8 - 11
8.8.1	Applicable connector conversion adapter	8 - 11
8.8.2	Installing procedure of connector conversion adapter	8 - 11
8.9	Serial Multi-Drop Connection Unit.....	8 - 12
8.9.1	Serial multi-drop connection unit	8 - 12
8.9.2	Applicable serial multi-drop connection unit	8 - 12
8.9.3	Installation.....	8 - 12

8.9.4	Parts name	8 - 13
8.9.5	Caution for compliance with EMC Directive.....	8 - 13
8.10	Panel-Mounted USB Port Extension.....	8 - 14
8.10.1	Applicable panel-mounted USB port extension	8 - 14
8.10.2	Parts name	8 - 14
8.10.3	Installing procedure	8 - 14
8.11	RS-232/485 Signal Conversion Adapter.....	8 - 16
8.11.1	Applicable RS-232/485 signal conversion adapter.....	8 - 16
8.11.2	Installing procedure of RS-232/485 signal conversion adapter	8 - 16

9. UTILITY FUNCTION

9.1	Utility Execution	9 - 1
9.2	Utility Function List.....	9 - 2
9.3	Utility Display	9 - 4
9.3.1	Display operation of main menu	9 - 6
9.3.2	Utility basic configuration.....	9 - 8
9.3.3	Basic operation of settings change.....	9 - 9

10. COMMUNICATION INTERFACE SETTING (COMMUNICATION SETTING)

10.1	Communication setting	10 - 1
10.1.1	Communication setting functions.....	10 - 1
10.1.2	Display operation of Communication Setting.....	10 - 1
10.1.3	Communication setting contents	10 - 2
10.1.4	Communication setting operation	10 - 4
10.2	Communication Detail Setting	10 - 8
10.2.1	Communication detail setting functions	10 - 8
10.2.2	Display operation of Communication Detail setting	10 - 8
10.2.3	Display contents of Communication Detail setting.....	10 - 10
10.3	Ethernet Setting	10 - 15
10.3.1	Ethernet setting functions	10 - 15
10.3.2	Display operation of Ethernet setting.....	10 - 15
10.3.3	Display contents of Ethernet setting	10 - 16

11. DISPLAY AND OPERATION SETTINGS (GOT SET UP)

11.1	Display Setting.....	11 - 1
11.1.1	Function of Display	11 - 1
11.1.2	Display operation of Display	11 - 2
11.1.3	Display operations	11 - 3
11.2	Operation Setting (Settings Regarding Operation).....	11 - 6
11.2.1	Operation setting functions	11 - 6
11.2.2	Display operation of Operation	11 - 7
11.2.3	Setting operation of operation	11 - 8
11.2.4	Security level change	11 - 9
11.2.5	Utility Call Key Setting	11 - 11
11.2.6	Adjusting the touch panel position (Touch panel calibration)	11 - 13
11.2.7	USB mouse/keyboard setting	11 - 15
11.3	Transparent Mode Setting	11 - 17
11.4	Backup/Restoration Setting	11 - 18
11.5	Behavior of Duplicate IPs	11 - 21

12. CLOCK SETTINGS AND BATTERY STATUS DISPLAY (TIME SETTING AND DISPLAY)

12.1	Time Setting and Display	12 - 1
12.1.1	Time setting and display functions.....	12 - 1

13. FILE DISPLAY AND COPY (PROGRAM/DATA CONTROL)

13.1	Data Storage Location	13 - 1
13.1.1	Data type and storage location	13 - 1
13.1.2	OS version confirmation	13 - 3
13.1.3	Capacity confirmation of the project data downloading location.....	13 - 4
13.1.4	Display file	13 - 4
13.2	Various Data Control	13 - 5
13.2.1	OS information.....	13 - 5
13.2.2	Alarm information.....	13 - 11
13.2.3	Project Information.....	13 - 17
13.2.4	Hard copy information.....	13 - 27
13.2.5	Advanced recipe information	13 - 33
13.2.6	Logging information	13 - 53
13.2.7	Memory card format.....	13 - 63
13.2.8	Memory information	13 - 65
13.2.9	USB device status display	13 - 66
13.2.10	SRAM control.....	13 - 68
13.2.11	GOT data package acquisition	13 - 73
13.2.12	Operator information management.....	13 - 74

14. GOT SELF CHECK (DEBUG AND SELF CHECK)

14.1	Debug	14 - 1
14.1.1	System monitor.....	14 - 1
14.1.2	A list editor	14 - 1
14.1.3	FX list editor	14 - 1
14.1.4	Backup/restoration.....	14 - 2
14.2	Self Check	14 - 3
14.2.1	Memory check	14 - 3
14.2.2	Drawing check	14 - 6
14.2.3	Font check	14 - 10
14.2.4	Touch panel check.....	14 - 12
14.2.5	I/O check.....	14 - 14
14.2.6	Ethernet status check	14 - 17
14.3	System Alarm Display.....	14 - 19
14.4	GOT start time	14 - 21

15. CLEANING DISPLAY SECTION (CLEAN)

16. INSTALLATION OF COREOS, BOOTOS AND STANDARD MONITOR OS

16.1	BootOS and Standard Monitor OS Required for Installation.....	16 - 2
16.2	Prior Preparations for Installing BootOS and Standard Monitor OS	16 - 3
16.3	BootOS and Standard Monitor OS Installation Using SD card or USB Memory.....	16 - 4
16.3.1	Installing when starting the GOT	16 - 5
16.3.2	Installing using the program/data control function (Utility).....	16 - 7

16.4	When Installing the Different Version of BootOS, Standard Monitor OS	16 - 9
16.5	CoreOS	16 - 11
16.5.1	Installing the CoreOS	16 - 11
16.5.2	When the CoreOS cannot be installed	16 - 13

17. MAINTENANCE AND INSPECTION

17.1	Daily Inspection	17 - 2
17.2	Periodic Inspection	17 - 2
17.3	Cleaning Method.....	17 - 3
17.4	Battery Voltage Low Detection and Battery Replacement.....	17 - 4
17.5	Backlight Shutoff Detection.....	17 - 7
17.5.1	Backlight shutoff detection and external alarm	17 - 7

18. TROUBLESHOOTING

18.1	GOT Restoration Sheet	18 - 1
18.2	Error Message and System Alarm.....	18 - 11
18.2.1	Error contents display	18 - 11
18.2.2	List of error message/system alarm.....	18 - 13

APPENDICES

Appendix.1	External Dimensions.....	App - 1
Appendix.2	Usage Condition of Utility Function	App - 7
Appendix.3	Transportation Precautions	App - 9
Appendix.3.1	Relevant models.....	App - 9
Appendix.3.2	Transportation guidelines	App - 9

INDEX

REVISIONS

MANUALS

The following table lists the manual relevant to this product.
Refer to each manual for any purpose.

Manual Name	Packaging	Manual Number (Model code)
GT Works3 Version1 Installation Procedure Manual	Enclosed in product	-
GT Designer3 Version1 Screen Design Manual (Fundamentals) 1/2, 2/2	Stored in CD-ROM	SH-080866ENG (1D7MB9)
GT Designer3 Version1 Screen Design Manual (Functions) 1/2, 2/2	Stored in CD-ROM	SH-080867ENG (1D7MC1)
GOT1000 Series Connection Manual (Mitsubishi Products) for GT Works3	Stored in CD-ROM	SH-080868ENG (1D7MC2)
GOT1000 Series Connection Manual (Non-Mitsubishi Products 1) for GT Works3	Stored in CD-ROM	SH-080869ENG (1D7MC3)
GOT1000 Series Connection Manual (Non-Mitsubishi Products 2) for GT Works3	Stored in CD-ROM	SH-080870ENG (1D7MC4)
GOT1000 Series Connection Manual (Microcomputer, MODBUS Products, Peripherals) for GT Works3	Stored in CD-ROM	SH-080871ENG (1D7MC5)
GT Simulator3 Version1 Operating Manual for GT Works3	Stored in CD-ROM	SH-080861ENG (1D7MB1)
GOT1000 Series User's Manual (Extended Functions, Option Functions) for GT Works3	Stored in CD-ROM	SH-080863ENG (1D7MB3)

QUICK REFERENCE

■ Creating a project

Obtaining the specifications and operation methods of GT Designer3	GT Designer3 Version1 Screen Design Manual (Fundamentals) 1/2, 2/2
Setting available functions on GT Designer3	
Creating a screen displayed on the GOT	
Obtaining useful functions to increase efficiency of drawing	
Setting details for figures and objects	GT Designer3 Version1 Screen Design Manual (Functions) 1/2, 2/2
Setting functions for the data collection or trigger action	
Setting functions to use peripheral devices	
Simulating a created project on a personal computer	GT Simulator3 Version1 Operating Manual for GT Works3

■ Connecting a controller to the GOT

Obtaining information of Mitsubishi products applicable to the GOT	GOT1000 Series Connection Manual (Mitsubishi Products) for GT Works3
Connecting Mitsubishi products to the GOT	
Connecting multiple controllers to one GOT (Multi-channel function)	
Establishing communication between a personal computer and a controller via the GOT (FA transparent function)	

Obtaining information of Non-Mitsubishi products applicable to the GOT	<ul style="list-style-type: none"> • GOT1000 Series Connection Manual (Non-Mitsubishi Products 1) for GT Works3 • GOT1000 Series Connection Manual (Non-Mitsubishi Products 2) for GT Works3
Connecting Non-Mitsubishi products to the GOT	
Obtaining information of peripheral devices applicable to the GOT	GOT1000 Series Connection Manual (Microcomputer, MODBUS Products, Peripherals) for GT Works3
Connecting peripheral devices including a barcode reader to the GOT	
■ Transferring data to the GOT	
Writing data to the GOT	GT Designer3 Version1 Screen Design Manual (Fundamentals) 1/2, 2/2
Reading data from the GOT	
Verifying a editing project to a GOT project	
■ Others	
Configuring the extended function and option function	GOT1000 Series User's Manual (Extended Functions, Option Functions) for GT Works3

ABBREVIATIONS AND GENERIC TERMS

■ GOT

Abbreviations and generic terms		Description
GOT1000 Series	GT1695	GT1695M-X Abbreviation of GT1695M-STBA, GT1695M-STBD
	GT1685	GT1685M-S Abbreviation of GT1685M-STBA, GT1685M-STBD
	GT1675	GT1675M-S Abbreviation of GT1675M-STBA, GT1675M-STBD
		GT1675M-V Abbreviation of GT1675M-VTBA, GT1675M-VTBD
		GT1675-VN Abbreviation of GT1675-VNBA, GT1675-VNBD
	GT1672	GT1672-VN Abbreviation of GT1672-VNBA, GT1672-VNBD
	GT1665	GT1665M-S Abbreviation of GT1665M-STBA, GT1665M-STBD
		GT1665M-V Abbreviation of GT1665M-VTBA, GT1665M-VTBD
	GT1662	GT1662-VN Abbreviation of GT1662-VNBA, GT1662-VNBD
	GT16	Abbreviation of GT1695, GT1685, GT1675, GT1672, GT1665, GT1662, GT1655, GT16 Handy GOT
	GT1595	GT1595-X Abbreviation of GT1595-XTBA, GT1595-XTBD
	GT1585	GT1585V-S Abbreviation of GT1585V-STBA, GT1585V-STBD
		GT1585-S Abbreviation of GT1585-STBA, GT1585-STBD
	GT157□	GT1575V-S Abbreviation of GT1575V-STBA, GT1575V-STBD
		GT1575-S Abbreviation of GT1575-STBA, GT1575-STBD
		GT1575-V Abbreviation of GT1575-VTBA, GT1575-VTBD
		GT1575-VN Abbreviation of GT1575-VNBA, GT1575-VNBD
		GT1572-VN Abbreviation of GT1572-VNBA, GT1572-VNBD
	GT156□	GT1565-V Abbreviation of GT1565-VTBA, GT1565-VTBD
		GT1562-VN Abbreviation of GT1562-VNBA, GT1562-VNBD
	GT155□	GT1555-V Abbreviation of GT1555-VTBD
		GT1555-Q Abbreviation of GT1555-QTBD, GT1555-QSBD
		GT1550-Q Abbreviation of GT1550-QLBD
	GT15	Abbreviation of GT1595, GT1585, GT157□, GT156□, GT155□
	GT145□	GT1455-Q Abbreviation of GT1455-QTBD, GT1455-QTBDE
		GT1450-Q Abbreviation of GT1450-QLBD, GT1450-QLBDE
	GT14	Abbreviation of GT1455-QTBD, GT1455-QTBDE, GT1450-QLBD, GT1450-QLBDE
	GT1275	GT1275-V Abbreviation of GT1275-VNBA, GT1275-VNBD
	GT1265	GT1265-V Abbreviation of GT1265-VNBA, GT1265-VNBD
	GT12	Abbreviation of GT1275, GT1265
GT115□	GT1155-Q Abbreviation of GT1155-QTBDQ, GT1155-QSBDQ, GT1155-QTBDA, GT1155-QSBDA, GT1155-QTBD, GT1155-QSBD	
	GT1150-Q Abbreviation of GT1150-QLBDQ, GT1150-QLBDA, GT1150-QLBD	
GT11	Abbreviation of GT115□, GT11 Handy GOT	
GT105□	GT1055-Q Abbreviation of GT1055-QSBD	
	GT1050-Q Abbreviation of GT1050-QBBD	
GT104□	GT1045-Q Abbreviation of GT1045-QSBD	
	GT1040-Q Abbreviation of GT1040-QBBD	
GT1030	Abbreviation of GT1030-LBD, GT1030-LBD2, GT1030-LBL, GT1030-LBDW, GT1030-LBDW2, GT1030-LBLW, GT1030-LWD, GT1030-LWD2, GT1030-LWL, GT1030-LWDW, GT1030-LWDW2, GT1030-LWLW, GT1030-HBD, GT1030-HBD2, GT1030-HBL, GT1030-HBDW, GT1030-HBDW2, GT1030-HBLW, GT1030-HWD, GT1030-HWD2, GT1030-HWL, GT1030-HWDW, GT1030-HWDW2, GT1030-HWLW	
GT1020	Abbreviation of GT1020-LBD, GT1020-LBD2, GT1020-LBL, GT1020-LBDW, GT1020-LBDW2, GT1020-LBLW, GT1020-LWD, GT1020-LWD2, GT1020-LWL, GT1020-LWDW, GT1020-LWDW2, GT1020-LWLW	
GT10	Abbreviation of GT105□, GT104□, GT1030, GT1020	

Abbreviations and generic terms			Description	
GOT1000 Series	Handy GOT	GT16 Handy GOT	GT1665HS-V	Abbreviation of GT1665HS-VTBD
		GT11 Handy GOT	GT1155HS-Q	Abbreviation of GT1155HS-QSBD
			GT1150HS-Q	Abbreviation of GT1150HS-QLBD
	GT SoftGOT1000		Abbreviation of GT SoftGOT1000	

■ Communication unit

Abbreviations and generic terms	Description
Bus connection unit	GT15-QBUS, GT15-QBUS2, GT15-ABUS, GT15-ABUS2, GT15-75QBUSL, GT15-75QBUS2L, GT15-75ABUSL, GT15-75ABUS2L
Serial communication unit	GT15-RS2-9P, GT15-RS4-9S, GT15-RS4-TE
RS-422 conversion unit	GT15-RS2T4-9P, GT15-RS2T4-25P
Ethernet communication unit	GT15-J71E71-100
MELSECNET/H communication unit	GT15-J71LP23-25, GT15-J71BR13
MELSECNET/10 communication unit	GT15-75J71LP23-Z ^{*1} , GT15-75J71BR13-Z ^{*2}
CC-Link IE Controller Network communication unit	GT15-J71GP23-SX
CC-Link IE Field Network communication unit	GT15-J71GF13-T2
CC-Link communication unit	GT15-J61BT13, GT15-75J61BT13-Z ^{*3}
CC-Link interface unit	GT11HS-CCL, GT11H-CCL
Interface converter unit	GT15-75IF900
Serial multi-drop connection unit	GT01-RS4-M
Connection Conversion Adapter	GT10-9PT5S
RS-232/485 signal conversion adapter	GT14-RS2T4-9P

*1 A9GT-QJ71LP23 + GT15-75IF900 set

*2 A9GT-QJ71BR13 + GT15-75IF900 set

*3 A8GT-J61BT13 + GT15-75IF900 set

■ Option unit

Abbreviations and generic terms	Description	
Printer unit	GT15-PRN	
Video/RGB unit	Video input unit	GT16M-V4, GT15V-75V4
	RGB input unit	GT16M-R2, GT15V-75R1
	Video/RGB input unit	GT16M-V4R1, GT15V-75V4R1
	RGB output unit	GT16M-ROUT, GT15V-75ROUT
Multimedia unit	GT16M-MMR	
CF card unit	GT15-CFCD	
CF card extension unit ^{*1}	GT15-CFEX-C08SET	
External I/O unit	GT15-DIO, GT15-DIOR	
Sound output unit	GT15-SOUT	

*1 GT15-CFEX + GT15-CFEXIF + GT15-C08CF set.

■ Option

Abbreviations and generic terms	Description	
CF card	GT05-MEM-16MC, GT05-MEM-32MC, GT05-MEM-64MC, GT05-MEM-128MC, GT05-MEM-256MC, GT05-MEM-512MC, GT05-MEM-1GC, GT05-MEM-2GC, GT05-MEM-4GC, GT05-MEM-8GC, GT05-MEM-16GC	
Memory card adaptor	GT05-MEM-ADPC	
SD card	L1MEM-2GBSD, L1MEM-4GBSD	
Option function board	GT16-MESB, GT15-FNB, GT15-QFNB, GT15-QFNB16M, GT15-QFNB32M, GT15-QFNB48M, GT11-50FNB, GT15-MESB48M	
Battery	GT15-BAT, GT11-50BAT	
Protective Sheet	For GT16	GT16-90PSCB, GT16-90PSGB, GT16-90PSCW, GT16-90PSGW, GT16-80PSCB, GT16-80PSGB, GT16-80PSCW, GT16-80PSGW, GT16-70PSCB, GT16-70PSGB, GT16-70PSCW, GT16-70PSGW, GT16-60PSCB, GT16-60PSGB, GT16-60PSCW, GT16-60PSGW, GT16-50PSCB, GT16-50PSGB, GT16-50PSCW, GT16-50PSGW, GT16-90PSCB-012, GT16-80PSCB-012, GT16-70PSCB-012, GT16-60PSCB-012, GT16-50PSCB-012, GT16H-60PSC
	For GT15	GT15-90PSCB, GT15-90PSGB, GT15-90PSCW, GT15-90PSGW, GT15-80PSCB, GT15-80PSGB, GT15-80PSCW, GT15-80PSGW, GT15-70PSCB, GT15-70PSGB, GT15-70PSCW, GT15-70PSGW, GT15-60PSCB, GT15-60PSGB, GT15-60PSCW, GT15-60PSGW, GT15-50PSCB, GT15-50PSGB, GT15-50PSCW, GT15-50PSGW
	For GT14	GT14-50PSCB, GT14-50PSGB, GT14-50PSCW, GT14-50PSGW
	For GT12	GT11-70PSCB, GT11-65PSCB
	For GT11	GT11-50PSCB, GT11-50PSGB, GT11-50PSCW, GT11-50PSGW, GT11H-50PSC
	For GT10	GT10-50PSCB, GT10-50PSGB, GT10-50PSCW, GT10-50PSGW, GT10-40PSCB, GT10-40PSGB, GT10-40PSCW, GT10-40PSGW, GT10-30PSCB, GT10-30PSGB, GT10-30PSCW, GT10-30PSGW, GT10-20PSCB, GT10-20PSGB, GT10-20PSCW, GT10-20PSGW
Protective cover for oil	GT05-90PCO, GT05-80PCO, GT05-70PCO, GT05-60PCO, GT05-50PCO, GT16-50PCO, GT10-40PCO, GT10-30PCO, GT10-20PCO	
USB environmental protection cover	GT16-UCOV, GT16-50UCOV, GT15-UCOV, GT14-50UCOV, GT11-50UCOV	
Stand	GT15-90STAND, GT15-80STAND, GT15-70STAND, A9GT-50STAND, GT05-50STAND	
Attachment	GT15-70ATT-98, GT15-70ATT-87, GT15-60ATT-97, GT15-60ATT-96, GT15-60ATT-87, GT15-60ATT-77, GT15-50ATT-95W, GT15-50ATT-85	
Backlight	GT16-90XLTT, GT16-80SLTT, GT16-70VLTN, GT16-70VLTTA, GT16-60VLTN, GT15-90XLTT, GT15-80SLTT, GT16-70SLTT, GT16-70VLTN, GT16-60SLTT, GT16-60VLTN, GT15-70SLTT, GT15-70VLTN, GT15-60VLTN, GT15-60VLTN	
Multi-color display board	GT15-XHNB, GT15-VHNB	
Connector conversion box	GT11H-CNB-37S, GT16H-CNB-42S	
Emergency stop sw guard cover	GT11H-50ESCOV, GT16H-60ESCOV	
Memory loader	GT10-LDR	
Memory board	GT10-50FMB	
Panel-mounted USB port extension	GT10-C10EXUSB-5S, GT14-C10EXUSB-4S	

■ Software

Abbreviations and generic terms	Description
GT Works3	Abbreviation of the SW□DNC-GTWK3-E and SW□DNC-GTWK3-EA
GT Designer3	Abbreviation of screen drawing software GT Designer3 for GOT1000 series
GT Simulator3	Abbreviation of screen simulator GT Simulator3 for GOT1000/GOT900 series
GT SoftGOT1000	Abbreviation of monitoring software GT SoftGOT1000
GT Converter2	Abbreviation of data conversion software GT Converter2 for GOT1000/GOT900 series
GT Designer2 Classic	Abbreviation of screen drawing software GT Designer2 Classic for GOT900 series
GT Designer2	Abbreviation of screen drawing software GT Designer2 for GOT1000/GOT900 series
iQ Works	Abbreviation of iQ Platform compatible engineering environment MELSOFT iQ Works
MELSOFT Navigator	Generic term for integrated development environment software included in the SW□DNC-IQWK (iQ Platform compatible engineering environment MELSOFT iQ Works)
GX Works2	Abbreviation of SW□DNC-GXW2-E and SW□DNC-GXW2-EA type programmable controller engineering software
GX Simulator2	Abbreviation of GX Works2 with the simulation function
GX Simulator	Abbreviation of SW□D5C-LLT-E(-EV) type ladder logic test tool function software packages (SW5D5C-LLT (-EV) or later versions)
GX Developer	Abbreviation of SW□D5C-GPPW-E(-EV)/SW D5F-GPPW-E type software package
GX LogViewer	Abbreviation of SW□DNN-VIEWER-E type software package
PX Developer	Abbreviation of SW□D5C-FBDQ-E type FBD software package for process control
MT Works2	Abbreviation of motion controller engineering environment MELSOFT MT Works2 (SW□DNC-MTW2-E)
MT Developer	Abbreviation of SW□RNC-GSV type integrated start-up support software for motion controller Q series
MR Configurator2	Abbreviation of SW□DNC-MRC2-E type Servo Configuration Software
MR Configurator	Abbreviation of MRZJW□-SETUP□E type Servo Configuration Software
FR Configurator	Abbreviation of Inverter Setup Software (FR-SW□-SETUP-WE)
NC Configurator	Abbreviation of CNC parameter setting support tool NC Configurator
FX Configurator-FP	Abbreviation of parameter setting, monitoring, and testing software packages for FX3U-20SSC-H (SW□D5C-FXSSC-E)
FX3U-ENET-L Configuration tool	Abbreviation of FX3U-ENET-L type Ethernet module setting software (SW1D5-FXENETL-E)
RT ToolBox2	Abbreviation of robot program creation software (3D-11C-WINE)
MX Component	Abbreviation of MX Component Version□ (SW□D5C-ACT-E, SW□D5C-ACT-EA)
MX Sheet	Abbreviation of MX Sheet Version□ (SW□D5C-SHEET-E, SW□D5C-SHEET-EA)
LCPU Logging Configuration Tool	Abbreviation of LCPU Logging Configuration Tool (SW1DNN-LLUTL-E)

■ License key (for GT SoftGOT1000)

Abbreviations and generic terms	Description
License	GT15-SGTKEY-U, GT15-SGTKEY-P

■ Others

Abbreviations and generic terms	Description
IAI	Abbreviation of IAI Corporation
AZBIL	Abbreviation of Azbil Corporation (former Yamatake Corporation)
OMRON	Abbreviation of OMRON Corporation
KEYENCE	Abbreviation of KEYENCE CORPORATION
KOYO EI	Abbreviation of KOYO ELECTRONICS INDUSTRIES CO., LTD.
SHARP	Abbreviation of Sharp Manufacturing Systems Corporation
JTEKT	Abbreviation of JTEKT Corporation
SHINKO	Abbreviation of Shinko Technos Co., Ltd.
CHINO	Abbreviation of CHINO CORPORATION
TOSHIBA	Abbreviation of TOSHIBA CORPORATION
TOSHIBA MACHINE	Abbreviation of TOSHIBA MACHINE CO., LTD.
HITACHI IES	Abbreviation of Hitachi Industrial Equipment Systems Co., Ltd.
HITACHI	Abbreviation of Hitachi, Ltd.
FUJI FA	Abbreviation of Fuji Electric FA Components & Systems Co., Ltd.
PANASONIC	Abbreviation of Panasonic Corporation
FUJI SYS	Abbreviation of Fuji Electric Systems Co., Ltd.
YASKAWA	Abbreviation of YASKAWA Electric Corporation
YOKOGAWA	Abbreviation of Yokogawa Electric Corporation
ALLEN-BRADLEY	Abbreviation of Allen-Bradley products manufactured by Rockwell Automation, Inc.
GE FANUC	Abbreviation of GE Fanuc Automation Corporation GE Fanuc Automation Corporation
LS IS	Abbreviation of LS Industrial Systems Co., Ltd.
SCHNEIDER	Abbreviation of Schneider Electric SA
SICK	Abbreviation of SICK AG
SIEMENS	Abbreviation of Siemens AG
RKC	Abbreviation of RKC INSTRUMENT INC.
HIRATA	Abbreviation of Hirata Corporation
MURATEC	Abbreviation of Muratec products manufactured by Muratec Automation Co., Ltd.
PLC	Abbreviation of programmable controller
Temperature controller	Generic term for temperature controller manufactured by each corporation
Indicating controller	Generic term for indicating controller manufactured by each corporation
Control equipment	Generic term for control equipment manufactured by each corporation
Controller	Generic term for controller manufactured by each corporation
PC CPU module	Abbreviation of PC CPU Unit manufactured by CONTEC CO., LTD
GOT (server)	Abbreviation of GOTs that use the server function
GOT (client)	Abbreviation of GOTs that use the client function
Windows® font	Abbreviation of TrueType font and OpenType font available for Windows® (Differs from the True Type fonts settable with GT Designer3)
Intelligent function module	Indicates the modules other than the PLC CPU, power supply module and I/O module that are mounted to the base unit
MODBUS® /RTU	Generic term for the protocol designed to use MODBUS® protocol messages on a serial communication
MODBUS® /TCP	Generic term for the protocol designed to use MODBUS® protocol messages on a TCP/IP network

HOW TO READ THIS MANUAL

■ Symbols

Following symbols are used in this manual.

■ Memory check operation
Carries out write/read check of memory.

POINT

When drive is not displayed
When the drive (memory) to check is not displayed, confirm the mounting procedure or memory type with reference to the following.

- 8,1 SD Card
- 8,2 USB Memory

When no faults are found in mounting, etc, a memory failure may be arisen.
Replace the SD card or USB memory or built-in flash memory (C drive).
For details of built-in flash memory, contact your local Mitsubishi (Electric System) Service.

The following example explains about Memory Check using built-in flash memory (C drive).
For the Built-in SD card (A drive) memory check, install the SD card before carrying out the same key operations as built-in flash memory. For the USB drive (E drive) memory check, install the USB memory before carrying out the check operations.

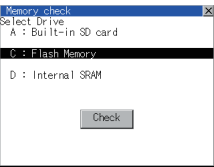

1. Select a drive to check in the Select Drive screen in Memory check and touch [Check] button.

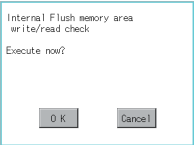

2. Touching [Check] button displays the dialog box on the left.
Selecting [OK] button displays the numeric keyboard window.
Selecting [Cancel] button returns to the initial menu.



3. Touch to input password (5920) and touch [Enter] key.
Touching [Enter] key executes read/write check for the built-in flash memory, which is completed in around 10 seconds.

POINT Refers to the information required.

HINT Refers to information useful for operation.

Indicates the location of related content.

Indicates the operation procedure.
Perform procedures in numerical order.

[] : Indicates the setting items displayed on the software and GOT screen.

[] : Refers to a button displayed on the computer screen or the GOT screen, or a key of the computer keyboard.

14 - 4 14 GOT SELF CHECK (DEBUG AND SELF CHECK)
14.2 Self Check

Since the above page was created for explanation purpose, it differs from the actual page.

1. OVERVIEW

■ About GOT

A GOT is installed on the panel surface of a control panel or operating panel and connects to the PLC within the control panel. The GOT carries out switch operation, lamp display, data display, message display, etc.

For the display screen, two kinds of screens are available: user screen and utility screen.

(1) User Screen

The user screen is a screen drawn by drawing software.

The objects [Touch switch], [Lamp display], [Comment display], and [Numeric display] can be arbitrarily arranged on the display.

Moreover, multiple screens created within drawing software can be individually selected or overlapped for the display.

For details, refer to the following.

 GT Designer3 Version1 Screen Design Manual

(2) Utility Screen

The utility screen is a factory drawn horizontal screen that cannot be edited.

Installing the BootOS or Standard monitor OS in the GOT from drawing software, the utility screen is displayed. The utility screen has options for [Brightness/contrast], [Memory check], etc.

For details, refer to the following.

 9. to 18.

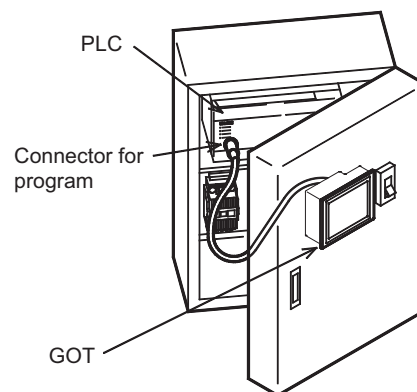

1.1 Features

Monitoring for turning ON/OFF bit devices of a PLC, forced turning ON/OFF the bit devices of a PLC, monitoring the word device set value/current value and changing that numeric values are easily made.

- (1) The display unit is used for engineers' stage replacement, setting change and troubleshooting or for operation guidance to an operator.
 - Monitor
 - Forced turning ON/OFF
 - Set value change
 - Trouble check
- (2) Improved monitoring performance and connectivity to FA devices
 - Multiple languages are displayed using the Unicode2.1-compatible fonts and beautiful characters are drawn using the TrueType and high quality fonts.
 - Two types of display modes are provided: 65536-color display and monochrome display
A fine and beautiful full-color display which shows even small characters clearly, is enabled in the 65536-color display by adopting the high intensity, wide viewing angle and high definition TFT color liquid crystal display. (Also compatible with digital screen displays with 65536 colors, BMP, etc.)
In the monochrome display, 16 scales are used to improve the display.
 - High speed monitoring through high speed communication at maximum of 115.2kbps.
 - High speed display and high speed touch switch response.
 - The operation performance is improved by the analog touch panel.
- (3) More efficient GOT operations including screen design, startup, adjustment, management and maintenance works
 - The 9MB built-in flash memory is included as standard.
 - SD card interface is included as standard.
 - RS-232 interface is included as standard.
 - RS-422/485 interface is included as standard.
 - USB interface (host/device) is included as standard.
 - Ethernet interface is included as standard.
 - System font types are increased by the adoption of the font installation system.
 - Four types of alarms (system alarm, user alarm, alarm history and alarm popup display) are integrated, and realizing an efficient alarm notification.
- (4) Enhanced support of FA device setup tools
 - Transferring or monitoring the sequence programs using the PC connected to GOT is available, during connection to A, QnA, L, Q, or FX series PLC CPU (FA Transparent function).

1.1.1 Rough procedure

The outline procedures before operating GOT and the descriptions of each item are shown below.

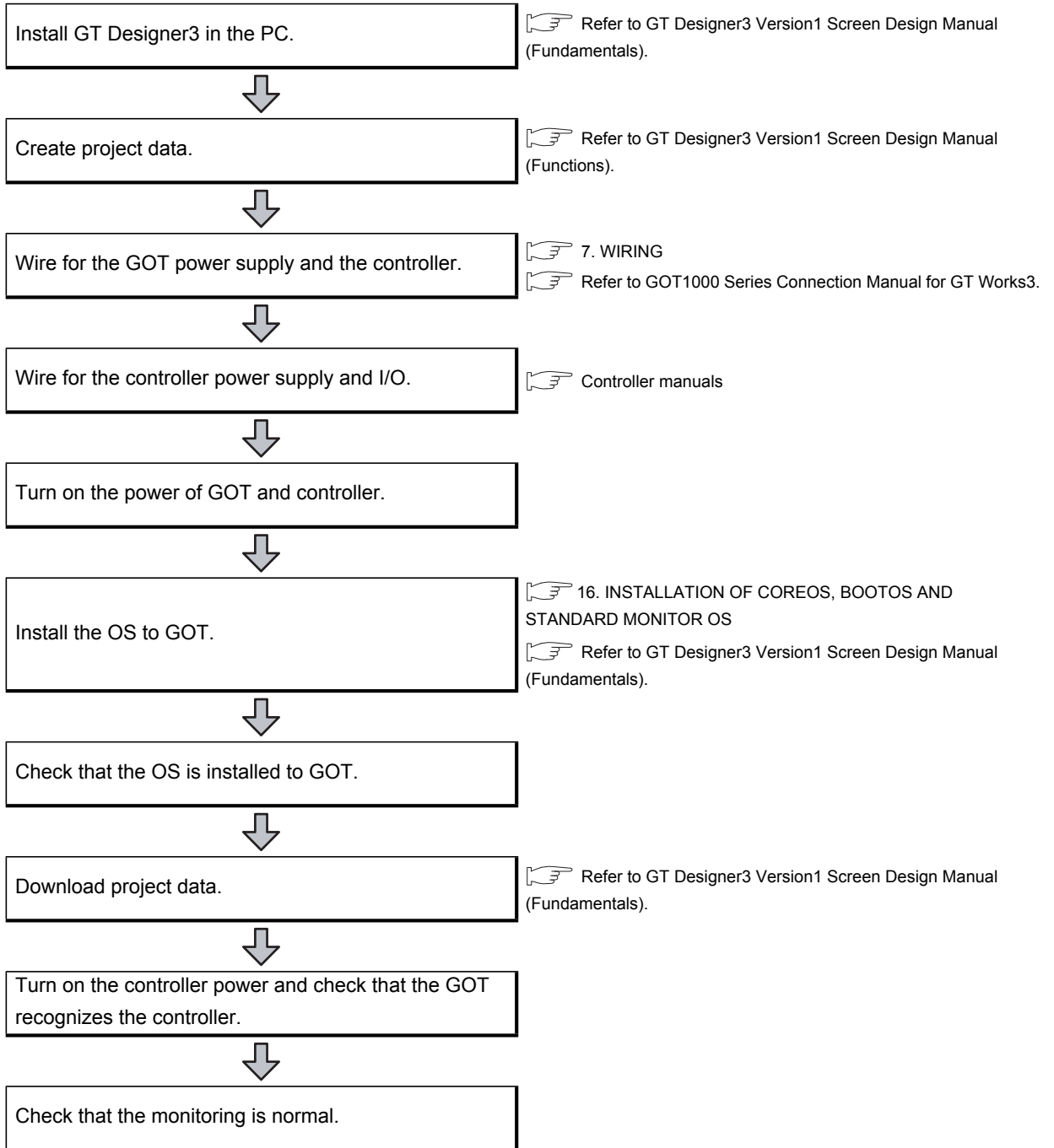

2. SYSTEM CONFIGURATION

2.1 Overall Configuration

The overall configuration of GOT is as follows.

For the connection methods applicable to GOT1000 series and cable, refer to the following.

 GOT1000 Series Connection Manual for GT Works3

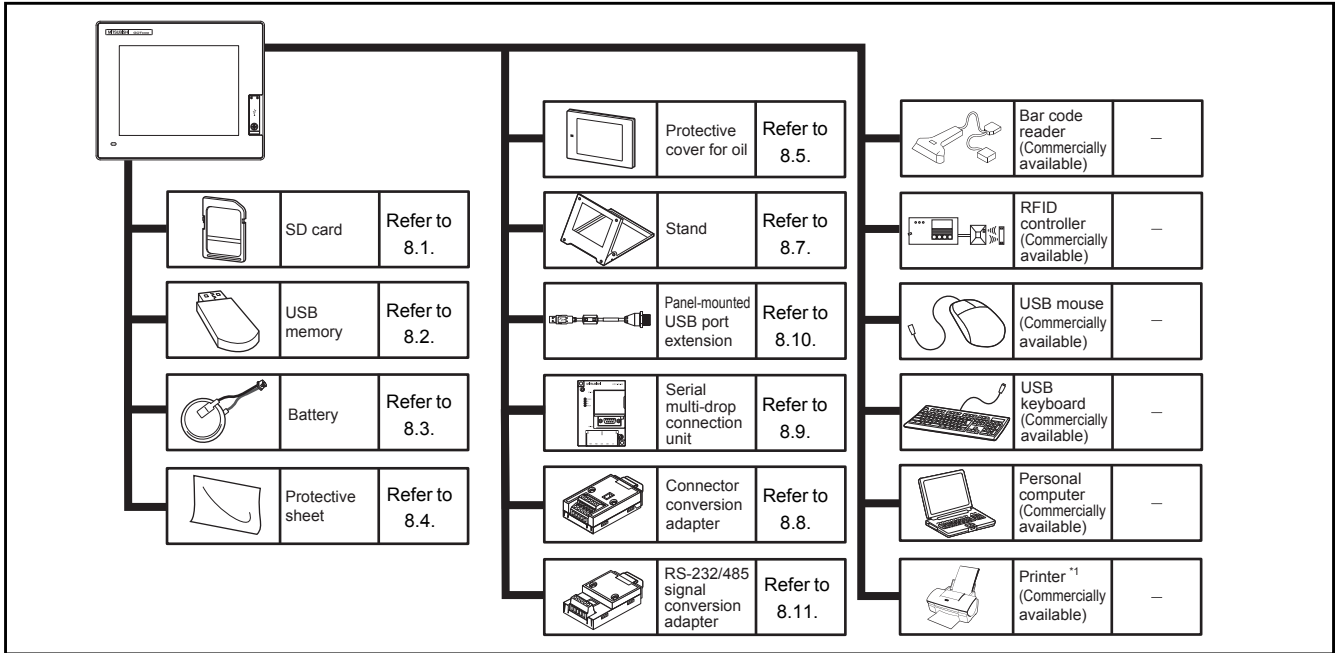

*1 Only hard copy of the screen can be printed.

2.2 System Equipment

(1) Explanation of the GOT model name

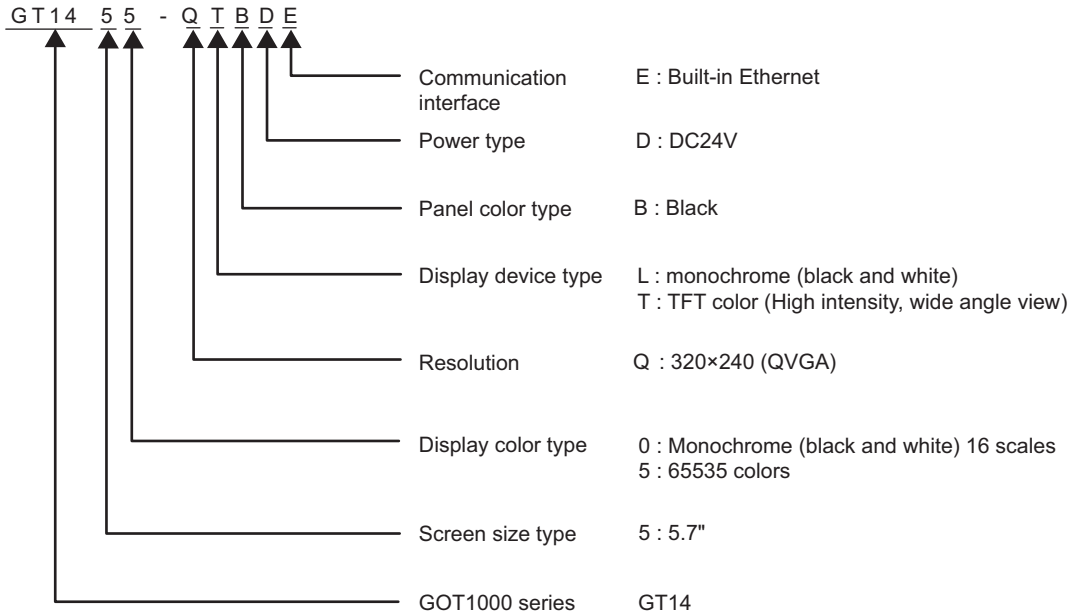

(2) Explanation of the option model name

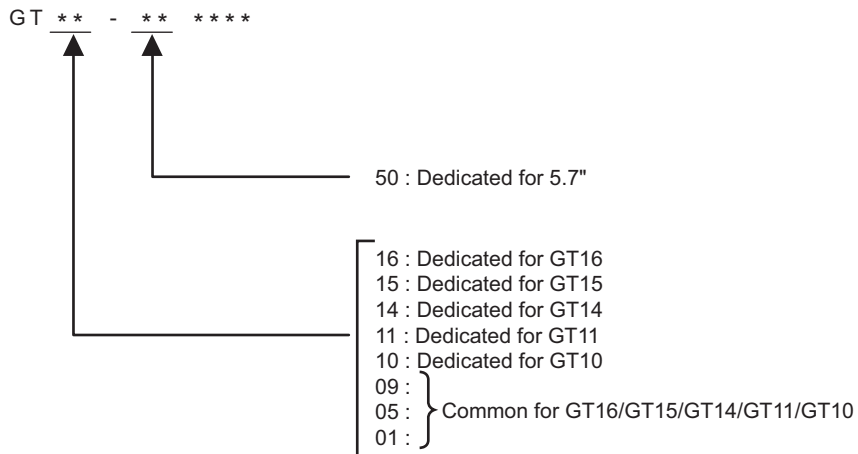

2.2.1 GOT (GT14)

Product name	Model name	Specifications
GOT	GT1455-QTBDE	5.7" [320 × 240 dots], TFT color liquid crystal display, 65536 colors, 24VDC, memory size 9MB, built-in battery, built-in Ethernet interface
	GT1455-QTBD	5.7" [320 × 240 dots], TFT color liquid crystal display, 65536 colors, 24VDC, memory size 9MB, built-in battery
	GT1450-QLBDE	5.7" [320 × 240 dots], STN monochrome liquid crystal display, monochrome (black/white), 24VDC, memory size 9MB, built-in battery, built-in Ethernet interface
	GT1450-QLBD	5.7" [320 × 240 dots], STN monochrome liquid crystal display, monochrome (black/white), 24VDC, memory size 9MB, built-in battery

2.2.2 Option

Connection cables for MITSUBISHI PLCs (Sold separately)

Product name	Model name	Cable length	Contents	
RS-422 cable	FXCPU direct connection cable, FX expansion board connection cable	GT01-C10R4-8P	1m	For connecting GOT to FXCPU (MINI DIN 8pin) For connecting GOT to FXCPU expansion board (MINI DIN 8pin)
		GT01-C30R4-8P	3m	
		GT01-C100R4-8P	10m	
		GT01-C200R4-8P	20m	
		GT01-C300R4-8P	30m	
	QnA/A/FXCPU direct connection cable, computer link connection cable	GT01-C30R4-25P	3m	For connecting GOT to QnA/A Motion controller CPU (A series), FXCPU (D-Sub 25pin)
		GT01-C100R4-25P	10m	
		GT01-C200R4-25P	20m	For connecting GOT to FA-CNV□CBL For connecting GOT to serial communication unit (AJ71QC24(N)-R4)
		GT01-C300R4-25P	30m	
	Computer link connection cable	GT09-C30R4-6C	3m	For connecting GOT to computer link module/serial communication unit
		GT09-C100R4-6C	10m	
		GT09-C200R4-6C	20m	
GT09-C300R4-6C		30m		
RS-232 cable	QCPU direct connection cable	GT01-C30R2-6P	3m	For connecting GOT to QCPU
	FX expansion board connection, FX special adaptor connection, data transfer cable	GT01-C30R2-9S	3m	For connecting GOT to FXCPU expansion board (D-Sub 9pin) For connecting GOT to FXCPU special adaptor (D-Sub 9pin)
		GT01-C30R2-25P	3m	For connecting GOT to FXCPU special adaptor (D-Sub 25pin)
	Computer link connection cable	GT09-C30R2-9P	3m	For connecting GOT to computer link module/serial communication unit
		GT09-C30R2-25P	3m	

Connection cables for OMRON PLCs (Sold separately)

Product name	Model name	Cable length	Contents
RS-422 cable	GT09-C30R40101-9P	3m	For connecting GOT to OMRON PLC, serial communication unit, serial communication board
	GT09-C100R40101-9P	10m	
	GT09-C200R40101-9P	20m	
	GT09-C300R40101-9P	30m	
	For connecting GOT to serial communication board	GT09-C30R40103-5T	3m
		GT09-C100R40103-5T	10m
		GT09-C200R40103-5T	20m
		GT09-C300R40103-5T	30m
RS-422 cable	GT09-C30R40102-9P	3m	For connecting GOT to OMRON rack type host link unit, communication board
	GT09-C100R40102-9P	10m	
	GT09-C200R40102-9P	20m	
	GT09-C300R40102-9P	30m	
RS-232 cable	GT09-C30R20101-9P	3m	For connecting GOT to OMRON PLC, serial communication unit, communication board, serial communication board
	GT09-C30R20102-25S	3m	For connecting GOT to OMRON connection cable
	GT09-C30R20103-25P	3m	For connecting GOT to OMRON rack type host link unit

Connection cables for KEYENCE PLCs (Sold separately)

Product name	Model name	Cable length	Contents
RS-422 cable	GT09-C30R41101-5T	3m	For connecting GOT to KEYENCE multi-communication unit
	GT09-C100R41101-5T	10m	
	GT09-C200R41101-5T	20m	
	GT09-C300R41101-5T	30m	
RS-232 cable	GT09-C30R21101-6P	3m	For connecting GOT to KEYENCE PLC
	GT09-C30R21102-9S	3m	For connecting GOT to KEYENCE multi-communication unit
	GT09-C30R21103-3T	3m	For connecting GOT to KEYENCE multi-communication unit

Connection cables for Panasonic PLCs (Sold separately)

Product name	Model name	Cable length	Contents
RS-232 cable	GT09-C30R20901-25P	3m	For connecting GOT to Panasonic RS422/232C conversion adapter
	GT09-C30R20902-9P	3m	For connecting GOT to the tool port or RS232C port of Panasonic PLC, computer communication unit
	GT09-C30R20903-9P	3m	For connecting GOT to the RS232C port of Panasonic PLC
	GT09-C30R20904-3C	3m	For connecting GOT to the RS232C port of Panasonic PLC

Connection cables for YASKAWA PLCs (Sold separately)

Product name	Model name	Cable length	Contents	
RS-422 cable	GT09-C30R40201-9P	3m	For connecting GOT to YASKAWA MEMOBUS module	
	GT09-C100R40201-9P	10m		
	GT09-C200R40201-9P	20m		
	GT09-C300R40201-9P	30m		
	RS-422 cable	GT09-C30R40202-14P	3m	For connecting GOT to YASKAWA PLC
		GT09-C100R40202-14P	10m	
		GT09-C200R40202-14P	20m	
		GT09-C300R40202-14P	30m	
RS-232 cable	GT09-C30R20201-9P	3m	For connecting GOT to YASKAWA PLC	
	GT09-C30R20202-15P	3m		
	GT09-C30R20203-9P	3m		
	GT09-C30R20204-14P	3m		
	GT09-C30R20205-25P	3m	For connecting GOT to YASKAWA MEMOBUS module	

Connection cables for YOKOGAWA PLCs (Sold separately)

Product name	Model name	Cable length	Contents
RS-422 cable	GT09-C30R40301-6T	3m	For connecting GOT to YOKOGAWA PC link module
	GT09-C100R40301-6T	10m	
	GT09-C200R40301-6T	20m	
	GT09-C300R40301-6T	30m	
	GT09-C30R40302-6T	3m	
	GT09-C100R40302-6T	10m	
	GT09-C200R40302-6T	20m	
	GT09-C300R40302-6T	30m	
	For connecting GOT to YOKOGAWA temperature controller	GT09-C30R40303-6T	3m
		GT09-C100R40303-6T	10m
		GT09-C200R40303-6T	20m
		GT09-C300R40303-6T	30m
		GT09-C30R40304-6T	3m
		GT09-C100R40304-6T	10m
		GT09-C200R40304-6T	20m
		GT09-C300R40304-6T	30m
RS-232 cable	GT09-C30R20301-9P	3m	For connecting GOT to YOKOGAWA CPU port/D-Sub 9pin conversion cable
	GT09-C30R20302-9P	3m	For connecting GOT to YOKOGAWA PC link module
	GT09-C30R20304-9S	3m	For connecting GOT to YOKOGAWA converter

Connection cables for Allen-Bradley PLCs (Sold separately)

Product name	Model name	Cable length	Contents
RS-232 cable	GT09-C30R20701-9S	3m	For connecting GOT to Allen-Bradley PLC
	GT09-C30R20702-25P	3m	For connecting GOT to Allen-Bradley Adapter

Connection cables for SIEMENS PLCs (Sold separately)

Product name	Model name	Cable length	Contents
RS-232 cable	GT09-C30R20801-9S	3m	For connecting GOT to SIEMENS HMI Adapter

Connection cables for SHINKO indicating controller PLCs (Sold separately)

Product name	Model name	Cable length	Contents
RS-232 cable	GT09-C30R21401-4T	3m	For connecting GOT to SHINKO indicating controller

SD card (Sold separately)

Product name	Model name	Contents
SD card	L1MEM-2GBSD	SD memory card 2GB
	L1MEM-4GBSD	SDHC memory card 4GB
	-	Commercially-available SD card *1

*1 Some models with the operations checked by our company are usable.
For the operation-checked models, refer to "Operation Check Results of Third Party SD Cards on GT14 Model" (Hime-T-P-0089) separately available, or contact your local distributor.

USB memory (Sold separately)

Product name	Model name	Contents
USB memory	-	Commercially-available USB memory *2

*2 Some models with the operations checked by our company are usable.
For the operation-checked models, refer to "List of valid devices applicable for GOT1000 series" (T10-0039) separately available, or contact your local distributor.

Battery (Sold separately)

Product name	Model name	Contents
Battery *3	GT11-50BAT	Battery for clock data, alarm history, recipe data, time action setting value, advanced alarm, advanced recipe, logging, hard copy, and SRAM user area backups

*3 At GOT purchase, it is installed in the main unit.

Stand (Sold separately)

Product name	Model name	Contents
Stand	GT05-50STAND	Stand for 5.7"

Protective cover for oil (Sold separately)

Product name	Model name	Contents
Protective cover for oil	GT05-50PCO	For 5.7" GOT

Protective sheet (Sold separately)

Product name	Model name	Contents	
Protective sheet	GT14-50PSCB	5.7" protective sheet	Clear 5 sheets
	GT14-50PSGB		Antiglare 5 sheets
	GT14-50PSCW		Clear (Frame: white) 5 sheets
	GT14-50PSGW		Antiglare (Frame: white) 5 sheets

Drawing software (Sold separately)

Product name	Model name	Contents
GT Designer3	SW□DNC-GTD3-E (□ indicates the version.)	Drawing software for GOT1000 series

PC connection cable (Sold separately)

Product name	Model name	Cable length	Contents
Project data transfer cable	GT09-C30USB-5P	3m	GOT (USB Mini-B) ↔ PC (USB)
	GT01-C30R2-9S	3m	GOT (D-Sub 9pin) ↔ PC (D-Sub 9pin)

Panel-mounted USB port extension (Sold separately)

Product name	Model name	Cable length	Contents
Panel-mounted USB port extension	GT14-C10EXUSB-4S	1m	Panel-mounted USB port extension, compatible with IP67f

Serial multi-drop connection unit (Sold separately)

Product name	Model name	Contents
Serial multi-drop connection unit	GT01-RS4-M	For GOT multi-drop connection

Connector conversion adapter (Sold separately)

Product name	Model name	Contents
Connector conversion adapter	GT10-9PT5S	For GOT multi-drop connection

Bar code reader, RFID controller (Sold separately)

Product name	Model name	Contents
Bar code reader	-	Commercially-available bar code reader *4
RFID controller	-	Commercially-available RFID controller *4

*4 Some models with the operations checked by our company are usable.
For the operation-checked models, refer to "List of valid devices applicable for GOT1000 series" (T10-0039) separately available, or contact your local distributor.

RS-232/485 signal conversion adapter (Sold separately)

Product name	Model name	Contents
RS-232/485 signal conversion adapter	GT14-RS2T4-9P	For GOT multi-drop connection, multi-channel function connection, temperature controller connection, and MODBUS(R)/RTU connection

1	OVERVIEW
2	SYSTEM CONFIGURATION
3	SPECIFICATIONS
4	PARTS NAME
5	UL, cUL STANDARDS AND EMC DIRECTIVE
6	INSTALLATION
7	WIRING
8	OPTION

3. SPECIFICATIONS

3.1 General Specifications

Item		Specifications					
Operating ambient temperature	Display section	0 to 50°C					
	Other than display section	0 to 55°C (when horizontally installed), 0 to 50°C (when vertically installed)					
Storage ambient temperature		-20 to 60°C					
Operating ambient humidity		10 to 90%, non-condensing (WBT: 39°C)					
Storage ambient humidity		10 to 90%, non-condensing					
Vibration resistance		Conforms to JIS B 3502 and IEC 61131-2		Frequency	Acceleration	Half-amplitude	Sweep count
			Under intermittent vibration	5 to 8.4Hz	-	3.5mm	10 times each in X, Y and Z directions
				8.4 to 150Hz	9.8m/s ²	-	
			Under continuous vibration	5 to 8.4Hz	-	1.75mm	-
8.4 to 150Hz	4.9m/s ²	-					
Shock resistance		Conforms to JIS B 3502, IEC 61131-2 (147 m/s ² , 3 times each in X, Y and Z directions)					
Operating atmosphere		Must be free of lamp black, corrosive gas, flammable gas, or excessive amount of electro conductive dust particles and must be no direct sunlight. (Same as for saving)					
Operating altitude *1		2000 m (6562 ft) max.					
Installation location		Inside control panel					
Overvoltage category *2		II or less					
Pollution degree *3		2 or less					
Cooling method		Self-cooling					
Grounding		Class D grounding (100Ω or less), to be connected to the panel when grounding is not possible.					

*1 Do not use or store the GOT under pressures higher than the atmospheric pressure of altitude 0m (0ft.). Failure to observe this instruction may cause a malfunction.

When the air inside the control panel is purged by pressurization, the surface sheet may be lifted by high pressure. As a result, the touch panel may be difficult to press, and the sheet may be peeled off.

*2 This indicates the section of the power supply to which the equipment is assumed to be connected between the public electrical power distribution network and the machinery within the premises.

Category II applies to equipment for which electrical power is supplied from fixed facilities.



The surge voltage withstand level for up to the rated voltage of 300V is 2500V.

*3 This index indicates the degree to which conductive pollution is generated in the environment where the equipment is used. In pollution degree 2, only non-conductive pollution occurs but temporary conductivity may be produced due to condensation.

3.2 Performance Specifications

The performance specifications are as follows.

Item	Specifications		
	GT1455-QTBD(E)	GT1450-QLBD(E)	
Display section *1	Type	TFT color liquid crystal display	Monochrome (black/white) liquid crystal display
	Screen size	5.7"	
	Resolution	320 × 240 dots	
	Display size	W115(4.53) × H86(3.39)[mm](inch) (Horizontal format)	
	Display character	16-dot standard font: 20 characters × 15 lines (Horizontal format), 12-dot standard font: 26 characters × 20 lines (Horizontal format)	
	Display color	65536 colors	Monochrome (black/white) 16 scales
	Display angle *2	Left/Right: 80 degrees, Top: 80 degrees, Bottom: 60 degrees (Horizontal format)	Left/Right: 45 degrees, Top: 20 degrees, Bottom: 40 degrees (Horizontal format)
	Intensity of liquid crystal display only	400[cd/m ²]	300[cd/m ²]
	Contrast adjustment	-	32-level adjustment
	Intensity adjustment	8-level adjustment	
	Life	Approx. 50,000h. (Time for contrast to become 1/5 at operating ambient temperature of 25°C)	
Backlight	LED type (irreplaceable) Backlight off/screen saving time can be set. *3		
Life	Approx. 70,000h or longer. (Time for display intensity reaches 50% at operating ambient temperature of 25°C)		
Touch panel ⁴	Type	Analog resistive film	
	Key size	Minimum 2 × 2 dots (per key)	
	Number of points touched simultaneously	Simultaneous presses not allowed. (Only 1 point can be touched.)	
	Life	1 million times (operating force 0.98N max.)	
Memory	C drive *5	Built-in flash memory, 9Mbytes (for storing project data and OS) Life (Number of write times): 100,000 times	
	D drive	SRAM (internal), 512Kbytes (battery backup)	
Battery		GT11-50BAT lithium battery	
	Backup target	Clock data, alarm history, recipe data, time action setting value, advanced alarm, advanced recipe, logging, hard copy and SRAM user area	
	Life	Approx. 5 years (Operating ambient temperature of 25°C)	
Built-in interface	RS-422/485	RS-422/485, 1ch Transmission speed: 115200/57600/38400/19200/9600/4800bps Connector shape: D-Sub 9pin (Female) Application: For communicating with a controller Terminating resistor: Open/110Ω/330Ω (Switched by terminating resistor selector switch) ⁶ (At factory shipment: 330Ω)	
	RS-232	RS-232, 1ch Transmission speed: 115200/57600/38400/19200/9600/4800bps Connector shape: D-Sub 9pin (Male) Application: For communicating with a controller, connecting a bar code reader/RFID, connecting a PC (project data upload/download, OS installation, FA transparent function)	
	Ethernet (Only for models equipped with Ethernet)	Data transfer method: 100BASE-TX, 10BASE-T, 1ch Connector shape: RJ-45 (modular jack) Application: For communicating with a controller, using the gateway function, connecting a PC (project data upload/download, OS installation, FA transparent function)	
	USB	USB (Full Speed 12Mbps), Host, 1ch Connector shape: TYPE-A Application: For transferring data, storing data	
		USB (Full Speed 12Mbps), device, 1ch Connector shape: Mini-B Application: For connecting a PC (project data upload/download, OS installation, FA transparent function)	
SD card	SD standard, 1ch Supported memory card: SDHC memory card, SD memory card Application: For uploading/downloading project data, OS installation, storing logging data		
Buzzer output	Single tone (tone length adjustable)		
Protective structure *7	IP67f (front section of the panel only)		
External dimensions	W164(6.46) × H135(5.32) × D55(2.17)[mm](inch)		
Weight	Approx. 0.7kg (Excluding mounting fixtures)		
Compatible software package (GT Designer3 version)	Version1.37P or later		

- *1 Bright dots (always lit) and dark dots (unlit) may appear on a liquid crystal display panel due to its characteristics. It is impossible to completely avoid this symptom, as the liquid crystal display comprises of a great number of display elements. Flickers may be observed depending on the display color.
 Please note that these dots appear due to its characteristic and are not caused by product defect.
 Flickers and partial discoloration may be generated on the liquid crystal display panel due to the display contents or the contrast adjustment. However, please note that these phenomena appear due to its characteristic and are not caused by product defect.
 There is a difference in the display brightness and the color tones between liquid crystal display panels. When using multiple liquid crystal display panels, please note that there is an individual difference between them.
 A crosstalk (shadow as an extension of the display) may appear on the liquid crystal display panel. Please note that it appears due to its characteristic.
 When the display section is seen from the outside of the display angle, the display color seems like it has changed. Please note that it appears due to its characteristic. Especially, the response time of a STN liquid crystal display is slower in the lower temperature due to its characteristic. Please use the display after checking the response time.
 Please note that the response time, brightness and color of the liquid crystal display panel may vary depending on the usage environmental temperature.
 When the same screen is displayed for a long time, an incidental color or partial discoloration is generated on the screen due to heat damage, and it may not disappear.
 To prevent the heat damage, the screen saver function is effective.
 For details on the screen saver function, refer to the following.
 11.1 Display Setting
- *2 Gradation inversion is a characteristic of liquid crystal display panel. Please be forewarned that depending on the displayed color, the visualization may be difficult even within the described view angle.
- *3 The GOT screen saving/backlight off function prevents images from becoming permanently etched on the display screen and increases the backlight life.
 11.1 Display Setting
- *4 The touch panel is analog resistive film-type. If you touch the panel simultaneously in 2 points or more, the switch that is located around the center of the touched point, if any, may operate. Do not touch the panel in 2 points or more simultaneously.
 Do not press the GOT display section with a pointed material as a pen or driver. Doing so can result in a damage or failure of the display section.
 An analog resistive film-type touch panel does not require adjustment usually. However, misalignment between object position and actual touched position may be caused as usage time passes. If misalignment between object position and actual touched position may occur, adjust the touch panel position. Misalignment between object position and actual touched position may operate an unintended object, which causes unintended operation by mis-output and mis-operation.
- *5 ROM in which new data can be written without deleting the written data
- *6 Set the terminating resistor selector switch of the GOT in accordance with the connection type when adopting GOT multidrop connection.
- *7 Note that this does not guarantee all user's operation environment. The protection is not applied when the interface environment protection cover is removed.
 In addition, the product may not be used in environments under exposition of oil or chemicals for a long period of time, or in environments filled with oil-mist.

3.3 Power Supply Specifications

Item	Specifications			
	GT1450-QLBD	GT1450-QLBDE	GT1455-QTBD	GT1455-QTBDE
Input power supply voltage	24VDC (+10% -15%), ripple voltage 200mV or less			
Fuse (built-in, irreplaceable)	1.6A			
Power consumption	7.68W (320mA/24V)	8.40W (350mA/24V)	7.68W (320mA/24V)	8.40W (350mA/24V)
At backlight off	6.72W (280mA/24V)	7.44W (310mA/24V)	6.72W (280mA/24V)	7.44W (310mA/24V)
Inrush current	30A or less (26.4VDC) 2ms			
Permissible instantaneous power failure time	Within 5ms			
Noise immunity	Noise voltage: 1000Vp-p, Noise width: 1μs (by noise simulator of 30 to 100Hz noise frequency)			
Dielectric withstand voltage	500VAC for 1 minute (across power supply terminals and earth)			
Insulation resistance	10MΩ or larger by insulation resistance tester (across power supply terminals and earth)			
Applicable wire size	0.75[mm ²] or more for power supply, 2[mm ²] or more for grounding			
Applicable solderless terminal	Solderless terminal for M3 screw RAV1.25-3, V2-N3A, FV2-N3A			

POINT

Operation at momentary power failure
 The GOT continues to operate even upon 5ms or shorter instantaneous power failure.
 The GOT stops operating if there is extended power failure or voltage drop, while it automatically resumes operation as soon as the power is restored.

4. PARTS NAME

4.1 Front Panel

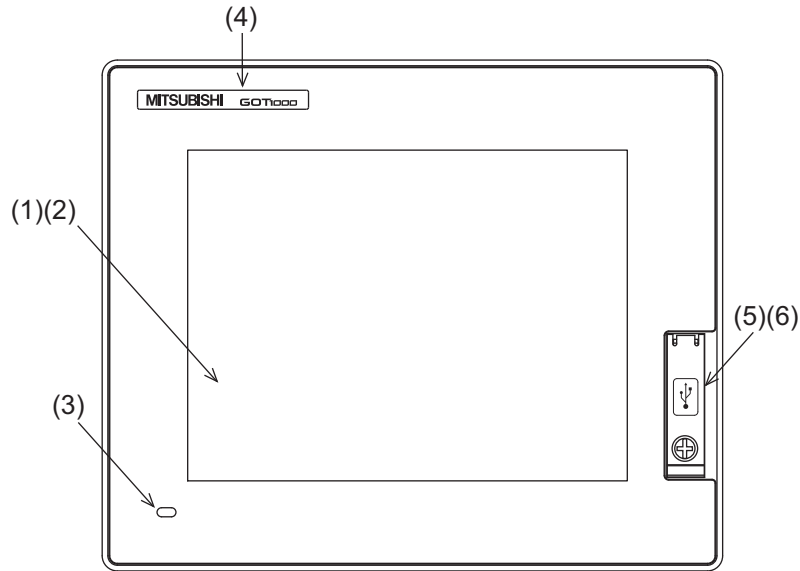

No.	Name	Description
(1)	Display section	Displays the utility screen and the user creation screen.
(2)	Touch panel	For touch switch operation on the utility screen and the user creation screen
(3)	POWER LED	Lit in green: Power is correctly supplied. Lit in orange: Screen saving. Blinks in orange/green: Blown back light bulb Not lit: Power is not supplied.
(4)	Logo label	Removable
(5)	USB interface	USB interface for communicating with PC (Device) For OS installation, project data download, and FA transparent
(6)	USB environmental protection cover	Opens/closes when the USB interface is used.

4.2 Back Panel

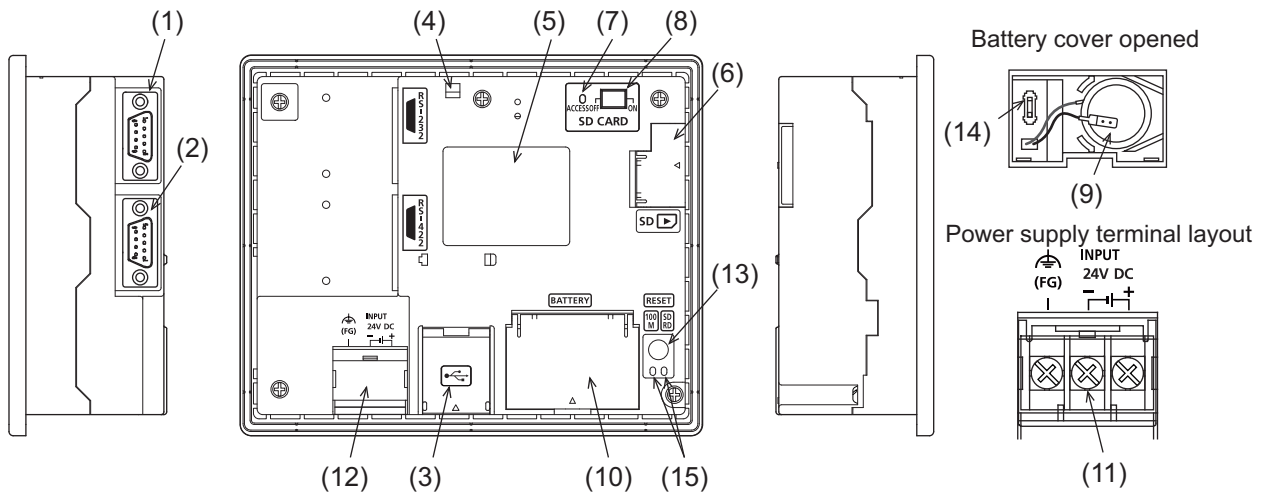

No.	Name	Description
(1)	RS-232 interface	For communicating with controller (PLC, microcomputer board, bar code reader, RFID, etc) or PC (OS installation, project data download, transparent) (D-sub 9pin male)
(2)	RS-422/485 interface	For communicating with controller (PLC, microcomputer board, etc) (D-sub 9pin female)
(3)	USB interface	USB interface for data transfer, data storage (host)
(4)	Preventive hole from removing for the USB cable	Hole fixed with banding band or others as a prevention from removing for the USB cable
(5)	Rating plate (nameplate)	The model name, current consumption, product number, H/W version, and BootOS version are described.
(6)	SD card interface	Interface for installing the SD card to the GOT
(7)	SD card access LED	Lit: SD card being accessed, Not lit: SD card is not accessed.
(8)	SD card access switch	Prohibits accessing the SD card removing the card from the GOT. ON: SD card being accessed (SD card removal prohibited) OFF: SD card not accessed (SD card removal possible)
(9)	Battery	GT11-50BAT battery for storing clock data, alarm history, recipe data, time action setting value, advanced alarm, advanced recipe, logging, hard copy and SRAM user area
(10)	Battery cover	Opens/closes when the battery is replaced or the terminating resistor is selected.
(11)	Power terminal	Power terminal and FG terminal (for power supply (24VDC) to GOT and grounding)
(12)	Power terminal cover	Opens/closes when the power terminal is connected. (color: transparent)
(13)	Reset switch	Switch for resetting the hardware (Use an isolated rod to operate.)
(14)	Terminating resistor selector switch	For switching the RS-422/485 communication interface terminating resistor
(15)	Ethernet communication status LED	SD RD: Turns on in green during data communication, 100M: Turns on in green during 100Mbps transmission.

4.3 Rear Face

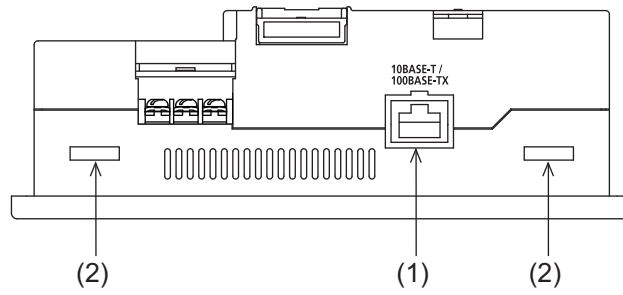

No.	Name	Description
(1)	Ethernet interface	For Ethernet connection to a controller (PLC microcomputer board) (RJ-45 connector)
(2)	Holes for unit mounting fixtures	Holes for the mounting fixtures (accessory) when the GOT is mounted to the panel (4 holes at top and bottom)

1

OVERVIEW

2

SYSTEM
CONFIGURATION

3

SPECIFICATIONS

4

PARTS NAME

5

UL, cUL
STANDARDS AND
EMC DIRECTIVE

6

INSTALLATION

7

WIRING

8

OPTION

5. UL, cUL STANDARDS AND EMC DIRECTIVE

5.1 UL, cUL Standards

UL, cUL Standard are recognized in use by the following combination (Model and Hardware version of the GOT/LOT.).

Item	Model	Hardware version of the GOT/LOT.
GOT	GT1455-QTBD GT1455-QTBDE GT1450-QLBD GT1450-QLBDE	Version C or later
RS-232/485 signal conversion adapter	GT14-RS2T4-9P	LOT.121 or later

POINT

- Checking method of hard ware version.
- Confirm the hardware version with the rating plate of the GOT.

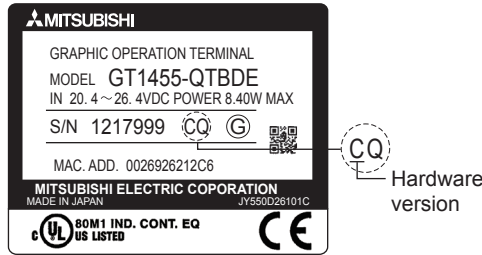

■ General notes on Power supply

This equipment must be supplied by a UL Listed or Recognized 24V DC rated power supply and UL Listed or Recognized fuse rated not higher than 4A, or a UL Listed Class 2 power supply.

5.2 EMC Directive

For the products sold in European countries, the conformance to the EMC Directive, which is one of the European Directives, has been a legal obligation since 1996. Also, conformance to the Low Voltage Directive, another European Directives, has been a legal obligation since 1997. Manufacturers who recognize their products must conform to the EMC and Low Voltage Directive are required to declare that their products conform to these Directives and put a "CE mark" on their products.

- This product is designed for use in industrial applications.
- Manufactured by: Mitsubishi Electric Corporation
2-7-3 Marunouchi, Chiyoda-ku, Tokyo 100-8310 Japan
- Manufactured at: Mitsubishi Electric Corporation Himeji Works
840 Chiyoda-machi, Himeji, Hyogo 670-8677 Japan
- Manufactured at: Mitsubishi Electric Corporation Nagoya Works
1-14 Yada-minami 5-Chome, Higashi-ku, Nagoya 461-0048 Japan
- Authorized Representative in the European Community: Mitsubishi Electric Europe B.V.
Gothaer Str. 8, 40880 Ratingen, Germany.

5.2.1 Requirements to Meet EMC Directive

EMC Directives are those which require "any strong electromagnetic force is not output to the external.:Emission (electromagnetic interference)" and "It is not influenced by the electromagnetic wave from the external.: Immunity (electromagnetic sensitivity)".

Items ■ EMC directive thru ■ Grounding summarize the precautions to use GOT and configure the mechanical unit in order to match the EMC directives.

Though the data described herein are produced with our best on the basis of the requirement items and standards of the restrictions gathered by Mitsubishi, they do not completely guaranteed that all mechanical unit manufactured according to the data do not always match the above directives. The manufacturer itself which manufactures the mechanical unit must finally judge the method and others to match the EMC directives.

■ EMC directive

The standards of the EMC Directive are shown below.

Applied standard	Test standard	Test details	Standard value
EN61131-2 : 2007	EN55011 Radiated noise* ¹	Electromagnetic emissions from the product are measured.	30M-230MHz QP: 30dB μ V/m (30m in measurement range)* ² , * ³ 230M-1000MHz QP: 37dB μ V/m(30m in measurement range)* ² , * ³
	EN61000-4-2 Electrostatic immunity* ¹	Immunity test in which static electricity is applied to the cabinet of the equipment.	\pm 4kV Contact discharge \pm 8kV Aerial discharge
	EN61000-4-3 Radiated field AM modulation* ¹	Immunity test in which field is irradiated to the product.	80-1000MHz:10V/m 1.4-2GHz:3V/m 2.0-2.7GHz:1V/m 80%AM modulation@1kHz
	EN61000-4-4 Fast transient burst noise* ¹	Immunity test in which burst noise is applied to the power line and signal lines.	Power line:2kV Digital I/O(24V or higher): 1kV (Digital I/O(24V or less))> 250V (Analog I/O, signal lines)> 250V
	EN61000-4-5 Surge immunity* ¹	Immunity test in which lightning surge is applied to the product.	Power line (between line and ground): \pm 0.5kV Power line (between lines): \pm 0.5kV Data communication port: \pm 1kV
	EN61000-4-6 Conducted RF immunity* ¹	Immunity test in which a noise inducted on the power and signal lines is applied.	Power line: 10V Data communication port: 10V
	EN61000-4-8 Power supply frequency magnetic field immunity	Test for checking normal operations under the circumstance exposed to the ferromagnetic field noise of the power supply frequency (50/60Hz).	30 A/m

*¹ The GOT is an open type device (device installed to another device) and must be installed in a conductive control panel. The above test items are conducted in the condition where the GOT is installed on the conductive control panel and combined with the Mitsubishi PLC.

*² QP: Quasi-peak value, Mean : Average value

*³ The above test items are conducted in the following conditions.
30M-230MHz QP : 40dB μ V/m (10m in measurement range)
230M-1000MHz QP : 47dB μ V/m (10m in measurement range)

■ Control panel

GOT is an open type device (device installed to another device) and must be installed in a conductive control panel. It not only assure the safety but also has a large effect to shut down the noise generated from GOT, on the control panel.

(1) Control panel

- (a) The control panel must be conductive.
- (b) When fixing a top or bottom plate of the control panel with bolts, do not coat the plate and bolt surfaces so that they will come into contact.
And connect the door and box using a thick grounding cable in order to ensure the low impedance under high frequency.
- (c) When using an inner plate to ensure electric conductivity with the control panel, do not coat the fixing bolt area of the inner plate and control panel to ensure conductivity in the largest area as possible.
- (d) Ground the control panel using a thick grounding cable in order to ensure the low impedance under high frequency.
- (e) Holes made in the control cabinet must be 10 cm (3.94inch) diameter or less. If the holes are 10cm (3.94inch) or larger, radio frequency noise may be emitted.
In addition, because radio waves leak through a clearance between the control panel door and the main unit, reduce the clearance as much as practicable.
The leakage of radio waves can be suppressed by the direct application of an EMI gasket on the paint surface.

(2) Connection of power and ground wires

Ground and power supply wires for the GOT must be connected as described below.

Provide a grounding point near the GOT. Short-circuit the FG terminals of the GOT (FG: frame ground) and ground them with the thickest and shortest wire possible (The wire length must be 30cm (11.81in.) or shorter.) The FG terminals function is to pass the noise generated in the PC system to the ground, so an impedance that is as low as possible must be ensured. As the wires are used to relieve the noise, the wire itself carries a large noise content and thus short wiring means that the wire is prevented from acting as an antenna.
Note) A long conductor will become a more efficient antenna at high frequency.

(3) Shock protection

In order to prevent those who are unfamiliar with power facility, e.g., an operator, from getting a shock, make sure to take the following measures on the control panel.

- (a) Store the GOT within the control panel locked, and allow only those who are familiar with power facility to unlock the panel.
- (b) Build the structure in order that the power supply will be shut off when the control panel is opened.

(4) Dustproof and waterproof features

The control panel also provides protection from dust, water and other substances. Insufficient ingress protection may lower the insulation withstand voltage, resulting in insulation destruction. The insulation in the GOT is designed to cope with the pollution level 2, so use in an environment with pollution level 2 or better.

Pollution level1 :	An environment where the air is dry and conductive dust does not exist.
Pollution level2 :	An environment where conductive dust does not usually exist, but occasional temporary conductivity occurs due to the accumulated dust. Generally, this is the level for inside the control panel equivalent a control room or on the floor of a typical factory.
Pollution level3 :	An environment where conductive dust exists and conductivity may be generated due to the accumulated dust. An environment for a typical factory floor.
Pollution level4 :	Continuous conductivity may occur due to rain, snow, etc. An outdoor environment.

■ Grounding

The following are applicable ground terminals. Use them in the grounded state.

Be sure to ground the GOT for ensuring the safety and complying with the EMC Directive.

Protective grounding  : Ensures the safety of the GOT and improves the noise resistance.

Functional grounding  : Improves the noise resistance.

5.2.2 EMC Directive-Compliant System Configuration

For information of the EMC Directive-compliant models please consult with your nearest Mitsubishi product provider.

■ GOT

Use any of the following GOTs with which CE mark logo is printed on the rating plate.
When using a GOT other than shown below, the system does not conform to the EMC Directive.

Item	Model	Hardware version of the GOT
GT1455-Q	GT1455-QTBD GT1455-QTBDE	Version C or later
GT1450-Q	GT1450-QLBD GT1450-QLBDE	Version C or later

POINT

Checking method of hard ware version.

Confirm the hardware version with the rating plate of the GOT.

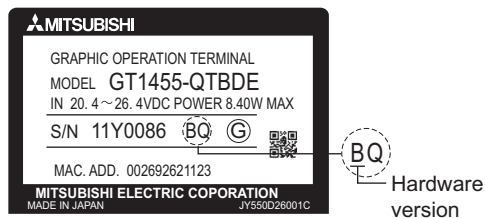

■ Connection method

Use the following methods to connect with the GOT to ensure compliance with the EMC Directive.

○ : Compliant with EMC Directive × : Not compliant with EMC Directive

Connection method ^{*1}	GT14
Direct connection to CPU	○
Computer link connection	×
CC-Link connection (via G4)	×
Ethernet connection	○
GOT multi-drop connection	×
Other connections	○ ^{*1}

^{*1} When connecting the GOT to other controllers as a PLC manufactured by other company, create the cable (by the user) and configure the system to meet the EMC Directive specifications for the connected device.

POINT

Connected devices

If connecting to the PLC or microcomputer other than Mitsubishi products (MELSEC-Q series, MELSEC-L series, MELSEC-QnA , MELSEC-A series or MELSEC-FX series) please refer to the EMC Directive compliance manual for that specific device.

■ About the cable used

Any device which utilizes a data communication function is susceptible to the wider effects of local EMC noise. Therefore, when installing any communication cables care should always be taken with the routing and location of those cables. The GOT identified on the previous page are compliant with the EMC requirement when the following communication cables are used.

- (1) Panel-mounted USB port extension
GT14-C10EXUSB-4S
- (2) Direct connection cable

Existing Cables	User Made Cables
GT01-C30R2-6P, GT01-C30R4-25P, GT01-C100R4-25P, GT01-C200R4-25P, GT01-C300R4-25P, GT01-C10R4-8P, GT01-C30R4-8P, GT01-C100R4-8P, GT01-C200R4-8P, GT01-C300R4-8P, GT01-C30R2-9S, GT01-C30R2-25P, WS0-C20R2	The cable need to be independently tested by the user to demonstrate EMC compatibility when they are used with the GOT, the PLC of MELSEC-Q series, MELSEC-L series, MELSEC-QnA, MELSEC-A series and MELSEC-FX series.

- (3) Ethernet connection cable
Shielded twisted pair cable (STP)
- (4) PLC (manufactured by other company), microcomputer, temperature controller, inverter, servo amplifier, CNC, MODBUS(R)/RTU or MODBUS(R)/TCP connection
Produce the cable (RS-232 cable, RS-422 / 485 cable) for connecting the GOT to a controller with reference to the following manual.

 GOT1000 Series Connection Manual for GT Works3 and a controller used

5.2.3 Precautions for Wiring/Connecting the EMC Directive-Compliant Product

Wire and connect GOT1000 series equipments as instructed below. If the GOT1000 series equipments are configured in a way different from the following instructions, the system may not comply with EMC directives.

■ Power and ground wires wiring method

- (1) Power and ground wires wiring method
Connect the power wire and connection cable as shown in the illustration, and be sure to attach a ferrite core (TDK Corporation type ZCAT3035-1330 or similar) within the range shown below.
Lead the power wire and ground wire as shown in 5.2.1 ■ Control panel (2).
Be sure to ground the FG cable, and protective ground cable.

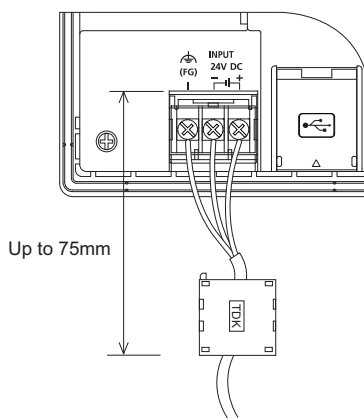

POINT

Any device which utilizes a data communication function is susceptible to the wider effects of local EMC noise. Therefore, when installing any communication cables care should always be taken with the routing and location of those cables.

Optional ferrite cores are recommended when the cable route is close to EMC noise sources like welders, large motors, etc.

All tests have been performed with original Mitsubishi cables. For customer prepared cables, please refer to the previous page.

GOT Unit	Existing Cables	User Made Cables
GT1450-QLBD GT1450-QLBDE GT1455-QTBD GT1455-QTBDE	Ex. GT01-C30R4-8P (as shown in EX.1)	3 rd party cables need to be independently tested by the user to demonstrate EMC compliance.

Example 1

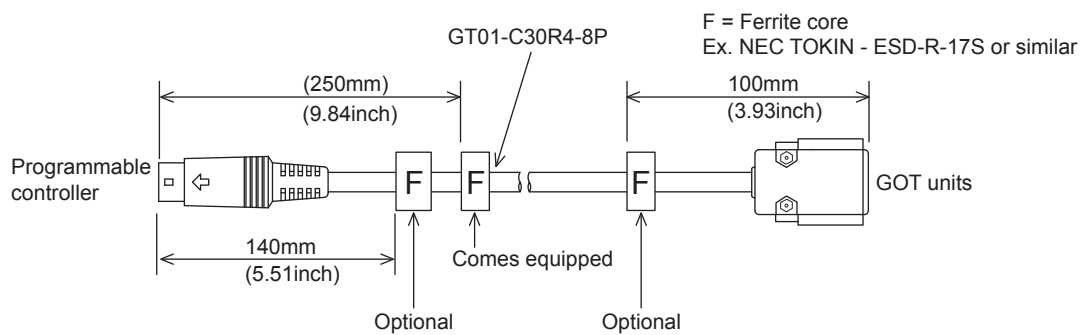

6. INSTALLATION

MOUNTING PRECAUTIONS **! DANGER**

- Be sure to shut off all phases of the external power supply used by the system before mounting or removing the GOT to/from the panel.
Not doing so can cause the unit to fail or malfunction.

MOUNTING PRECAUTIONS **! CAUTION**

- Use the GOT in the environment that satisfies the general specifications described in this manual. Not doing so can cause an electric shock, fire, malfunction or product damage or deterioration.
- Never drop cutting chips and electric wire chips into the ventilation window of the GOT when you drill screw holes or perform wiring. Otherwise, fire, failure or malfunction may be caused.
- Connect connection cables securely to the specified connectors while the power is turned OFF. Imperfect connection may cause malfunction or failure.
- Operate and store the GOT in environments without direct sunlight, dust, lamp black, conductive dust, corrosive gas, combustible gas, high temperature, condensation, wind, rain, vibrations and impacts. Electric shock, fire, malfunction, product damage or deterioration can be caused.
- Tighten the mounting screws within the specified torque range. Undertightening can cause the GOT to drop, short circuit or malfunction. Also, undertightening can disable waterproof or oil proof effect. Overtightening can cause a drop, short circuit or malfunction due to the damage of the screws or the GOT. Also, "distortion" of the GOT or the panel may disable waterproof or oil proof effect.

6.1 Control Panel Inside Dimensions for Mounting GOT

Mount the GOT onto the control panel while considering the following control panel inside dimensions. Vertical installation of the GOT requires a space with the same dimensions as the horizontal installation turned 90 degrees clockwise (seen from the display side).

POINT

Applicable cable

Some cables may need to be longer than the specified dimensions when connecting to the GOT. Therefore, consider the connector dimensions and bending radius of the cable as well for installation.

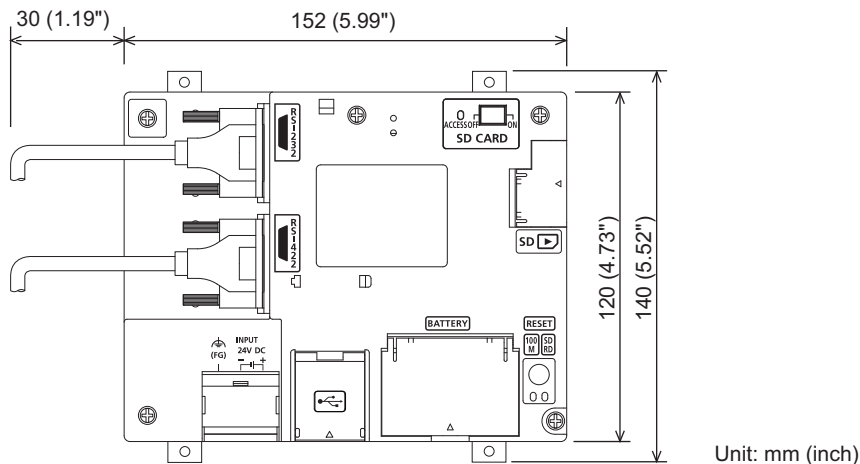

6.2 Panel Cutting Dimension

Make holes in the panel according to the dimensions list below.
Also, ensure 10mm of space in upper and lower parts of the panel for mounting fixtures.

- Horizontal format (If the vertical format is selected, the dimension must be rotated 90 degrees.)

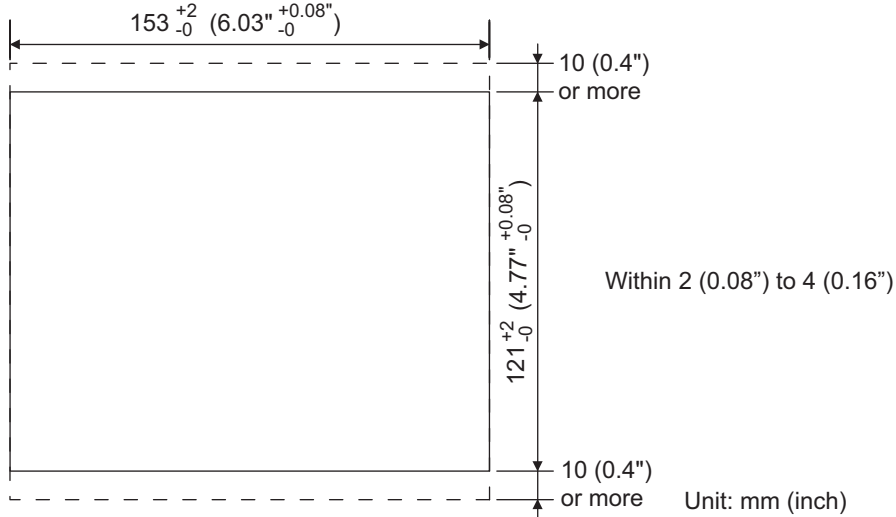

6.3 Mounting Position

When mounting the GOT, the following clearances must be maintained from other structures and devices.

- The below diagram represents a horizontal installation. (The same clearances must be maintained when rotating the GOT 90 degrees clockwise for a vertical installation.)

Installation Environment	A, D	B	C	E
In the presence of radiated-noise or heat-generating equipment nearby	50mm or more	80mm or more ^{*1}	50mm or more ^{*2}	100mm or more
In the absence of radiated-noise or heat-generating equipment nearby	20mm or more	20mm or more	20mm or more	20mm or more

*1 Vertical Format...50 mm (1.97") or more

*2 Vertical Format...80 mm (3.14") or more

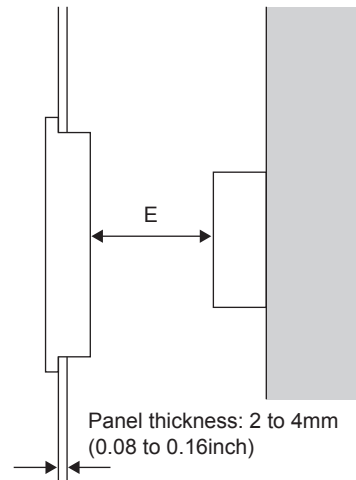
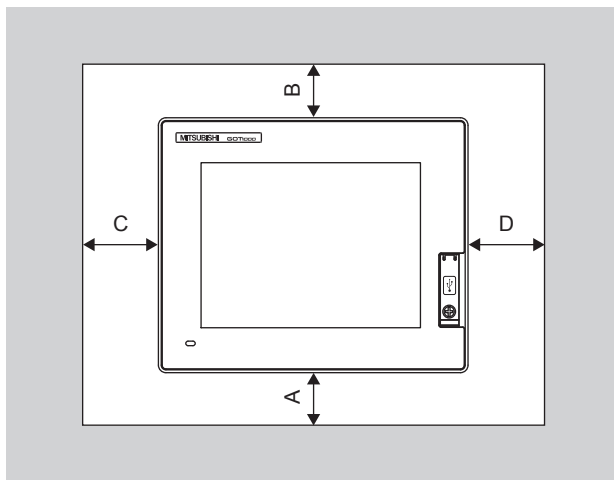

6.4 Control Panel Temperature and Mounting Angle

When mounting the main unit to a control panel or similar fixture, set the GOT display section as shown below.

■ Horizontal installation

When the temperature inside the control panel is 40 to 55°C, the mounting angle should be in the range from 60 to 105 degrees.

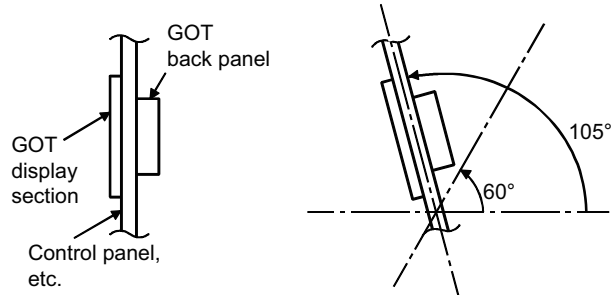

The GOT will have a longer lifetime if used within the mounting angles shown above. Ideally, the temperature inside the control panel should not exceed 0 to 40°C.

■ Vertical installation

When the temperature inside the control panel is 40 to 50°C, the mounting angle should be in the range from 60 to 105 degrees.

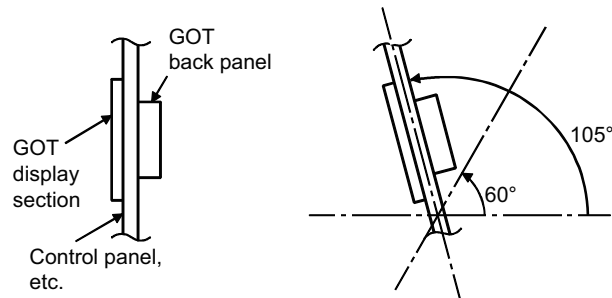

The GOT will have a longer lifetime if used within the mounting angles shown above. Ideally, the temperature inside the control panel should not exceed 0 to 40°C.

6.5 Installation Procedure

The GOT is designed to be embedded into a panel. Mount the GOT by following the procedure below. For the panel cutting dimension, refer to "6.2 Panel Cutting Dimension". Also, be sure that the thickness of the mounting panel face is 2 to 4mm.

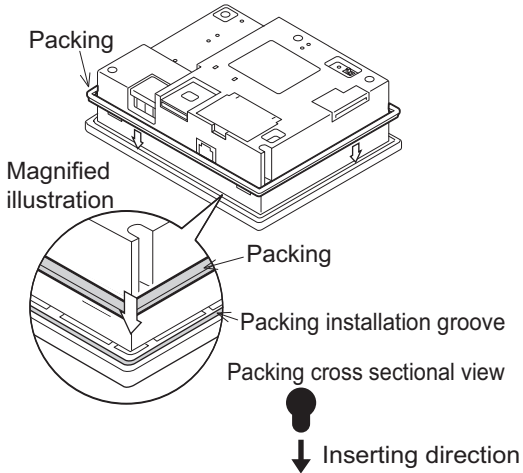

- 1. Installing the packing**
Install packing to the packing installation groove on the back panel of the GOT.
While referring to the cross sectional view of the packing shown left, push the thinner side into the packing groove.
(Left drawing is the example of lateral format.)

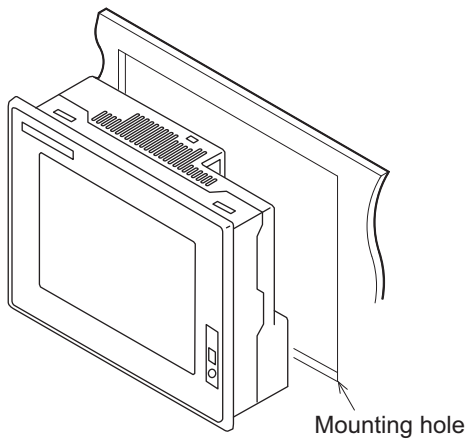

- 2. Inserting into the panel face**
Insert the GOT from the front side of the panel.

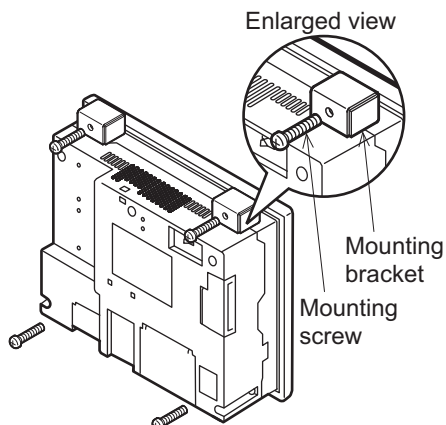

- 3. Fixing the GOT**
Engage the hook of the mounting fixture (accessory) to the unit fixing hole of the GOT and fix them by tightening the mounting screws in the torque range of 0.3 to 0.5N·m.

- 4.** A protection film is attached on the display section of GOT prior to shipment.
Remove the film when the installation is completed.

POINT

Cautions on installation

(1) Tightening the mounting screw

Tighten the mounting screws within the specified torque range.

Undertightening can cause a drop and disable waterproof or oil proof effect.

Overtightening may damage the unit, or distort the panel and make a surface waviness on the display area, leading to deterioration of the visibility or incorrect input from the touch panel. Also, overtightening can disable waterproof or oil proof effect.

- Specified torque range: 0.3 to 0.5N·m

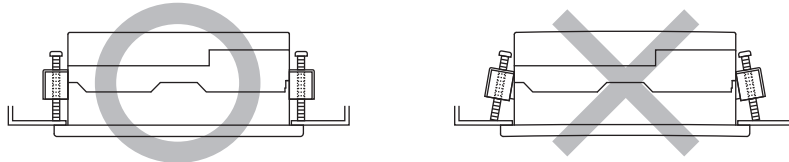

(2) Mounting panel face

Make sure that the panel surface is free from warpage, flaws and irregularities. Warpage, flaws and irregularities may disable the waterproof effect.

Select proper panel thickness under consideration of the panel strength.

(For example, the panel strength may be insufficient depending on the panel material and dimensions even if the panel thickness is acceptable. Insufficient panel strength may cause warpage depending on the installation positions of the GOT and other equipment.)

7. WIRING

1	OVERVIEW
2	SYSTEM CONFIGURATION
3	SPECIFICATIONS
4	PARTS NAME
5	UL, cUL STANDARDS AND EMC DIRECTIVE
6	INSTALLATION
7	WIRING
8	OPTION

WIRING PRECAUTIONS	 DANGER
<ul style="list-style-type: none">• Be sure to shut off all phases of the external power supply used by the system before wiring. Failure to do so may result in an electric shock, product damage or malfunctions.• Please make sure to ground FG terminal of the GOT power supply section by applying 100 or less which is used exclusively for the GOT. Not doing so may cause an electric shock or malfunction.• Correctly wire the GOT power supply section after confirming the rated voltage and terminal arrangement of the product. Not doing so can cause a fire or failure.• Tighten the terminal screws of the GOT power supply section in the specified torque range. Undertightening can cause a short circuit or malfunction. Overtightening can cause a short circuit or malfunction due to the damage of the screws or the GOT.• Exercise care to avoid foreign matter such as chips and wire offcuts entering the GOT. Not doing so can cause a fire, failure or malfunction.	

WIRING PRECAUTIONS	 CAUTION
<ul style="list-style-type: none">• Plug the communication cable into the connector of the connected unit and tighten the mounting and terminal screws in the specified torque range. Undertightening can cause a short circuit or malfunction. Overtightening can cause a short circuit or malfunction due to the damage of the screws or unit.	

This chapter describes the wiring to the GOT power supply section.
For the connection with a PLC, refer to the following.

 GOT1000 Series Connection Manual for GT Works3

For the dimensional drawing of connection cables, refer to the following.

 Appendix.1 External Dimensions

HINT

General preventive measures against noise

There are two kinds of noises: Radiated noise that is transmitted into the air and Conductive noise that is directly transmitted along connected lines.

Countermeasures must be taken considering both kinds of noises and referring to the following 3 points.

- (1) Protecting against noise
 - (a) Keep signal lines away from noise sources such as a power cable or a highpower drive circuit.
 - (b) Shield the signal lines.
- (2) Reducing generated noise
 - (a) Use a noise filter, etc. to reduce the level of the noise generated due to a source such as a high-power motor drive circuit.
 - (b) Attach surge killers to the terminals on the No Fuse Breaker (NFB), electromagnetic contactors, relays, solenoid valves, and generators to suppress noise interference.
- (3) Releasing noise to the ground
 - (a) Make sure to connect the ground cable to the ground.
 - (b) Use a short and thick cable to lower its impedance.
 - (c) Ground the power system and the control system separately.

7.1 Power Supply Wiring

7.1.1 Wiring example

Connect the power supply to the power terminals on the back panel of the GOT.

Use 0.75mm² or thicker cables to avoid voltage drop and tighten the terminal screw with the specified torque securely.

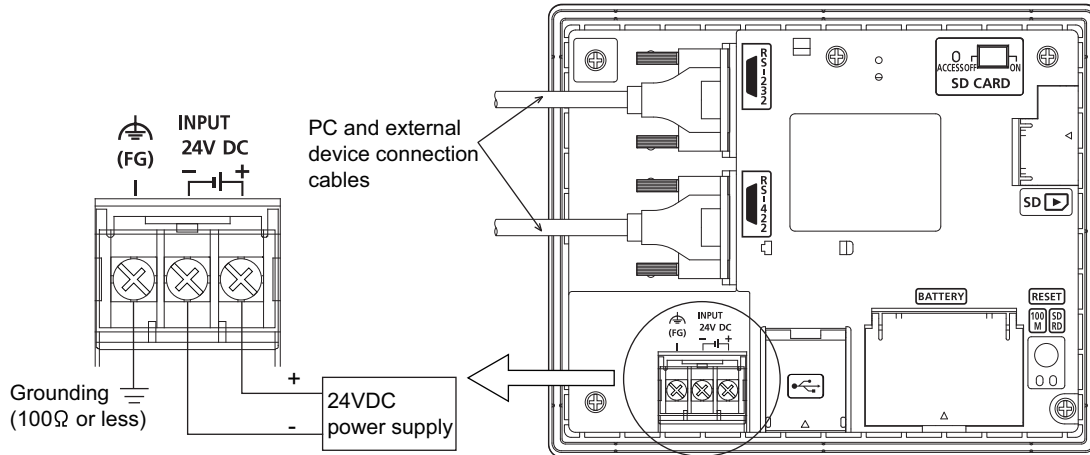

7.1.2 Grounding the GOT

■ About grounding

Make sure to carry out the following for grounding.

- Carry out the independent grounding if possible.
Apply the class D grounding. (Keep the grounding resistance within 100 Ω or less.)
- If the independent grounding is impossible, carry out the shared grounding as shown in fig.2) below.

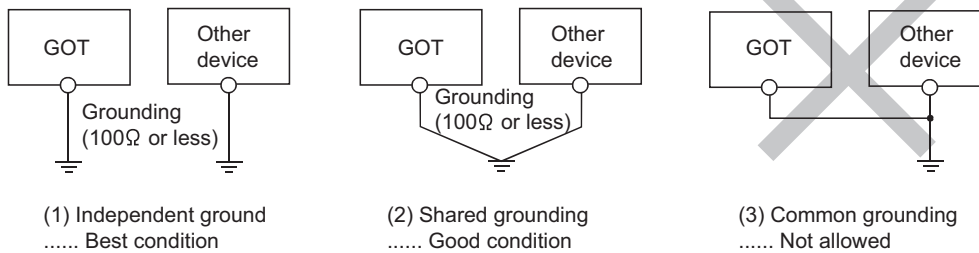

- Use the cable of 2mm² or more for grounding.
Set the grounding point closer to the GOT to make the grounding cable short as possible.

Recommended terminal shape

Terminal screws should be tightened to between 0.5 to 0.8N·m. Terminal screws must be secured to prevent a loose connection thus avoiding a malfunction.

Do not tighten the terminal screw with a torque exceeding the specified torque. Failure to do so may cause equipment failures or malfunctions.

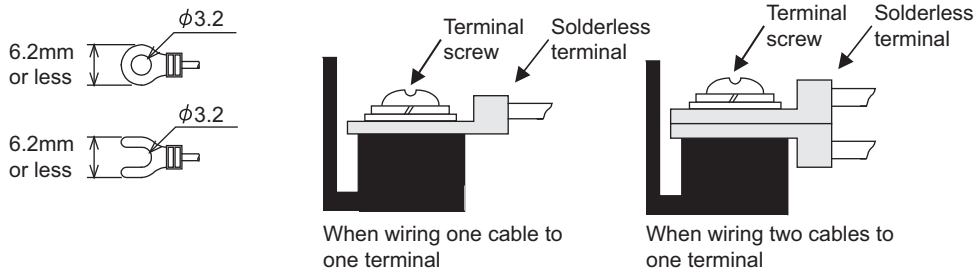

Cable size	For power supply: 0.75mm ² or more For grounding: 2mm ² or more
Solderless terminal	M3 solderless terminal (applicable solderless terminal: RAV1.25-3, V2-N3A, FV2-N3A)
Tightening torque	0.5 to 0.8N·m

7.1.3 The cause of malfunctions related wiring/Remedy

Grounding of the GOT may cause electric potential difference and noise interference, which may result in GOT malfunctions. These problems may be resolved by taking the following measures.

Wiring path of the GOT's ground cable and power line

Bundling the GOT's ground cable and power line together can cause interference noise, which may result in malfunctions.

Keeping the GOT's ground cable and power line away from each other will help minimize noise interference.

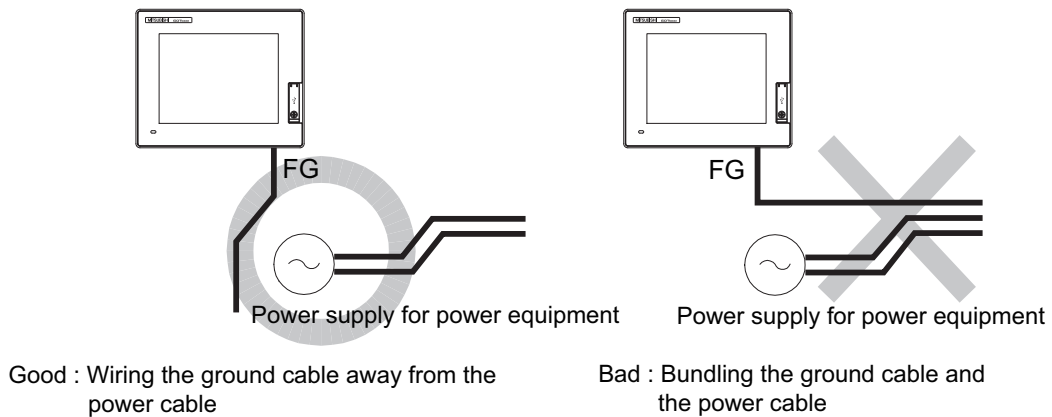

■ Connecting the ground cable from the panel that houses control equipment to the panel to which the GOT is grounded

When running a single ground cable from the panel that houses such piece of control equipment as a PLC to the panel to which the GOT is grounded, the ground cable may have to be directly connected to the terminal on the GOT.

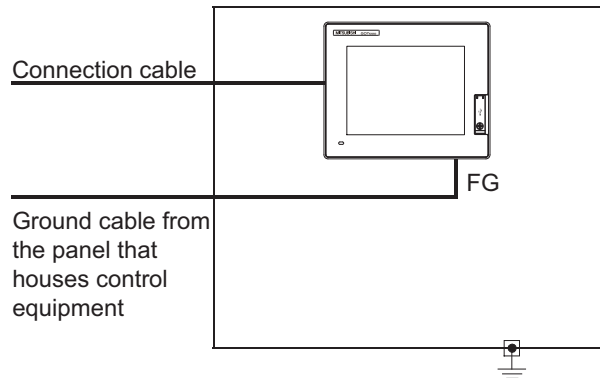

If electric potential difference between the ground points created by it causes malfunctions, lowering the voltage as shown in Remedy 1 below may solve the problem.

- Remedy 1 (Refer to the figures Remedy 1-1 and 1-2 below.)
 If the electric potential difference between the ground cable and the panel that houses the GOT is creating problems, connect the ground cable to the panel also.
 If the wiring method as shown in Remedy 1-1 is not feasible, follow Remedy 1-2.

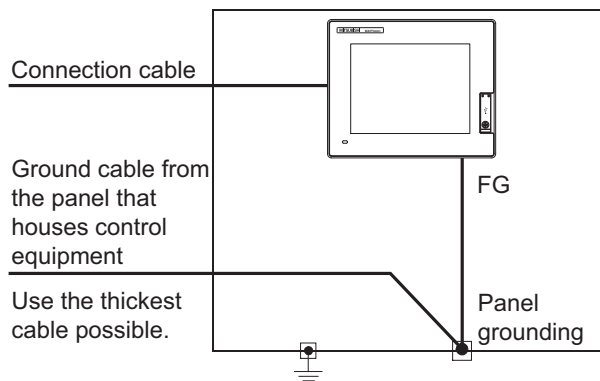

Remedy 1-1

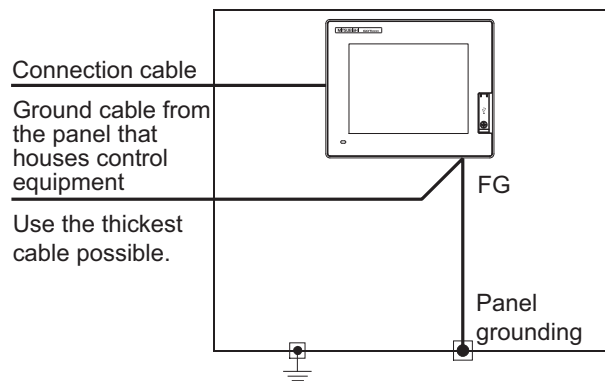

Remedy 1-2

If taking Remedy 1 worsens noise interference, taking Remedy 2 may alleviate it.

- Remedy 2 (Refer to the figures Remedy 2-1 and 2-2 below.)
 Attach a ferrite core to the cable if noise from the GOT panel has adverse effects on the GOT when Remedy 1 is taken.
 Wind the wire around the ferrite core several times (approx. 3 times), if a ferrite core is used.
 If the wiring method as shown in Remedy 2-1 is not feasible, follow Remedy 2-2.

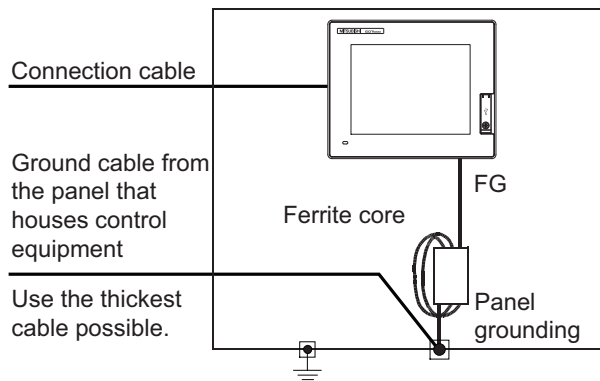

Remedy 2-1

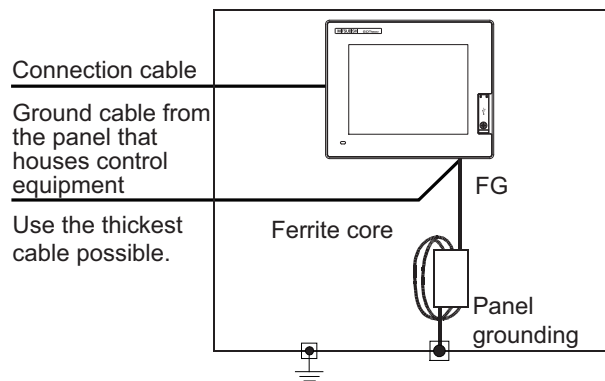

Remedy 2-2

7.2 Wiring inside and outside the panel

7.2.1 Wiring inside

Run power lines, servo amplifier drive wires, and communication cables so that they do not cross each other. Noise interference that is generated by cables that cross each other may cause malfunctions. Surge suppressors are an effective way to filter out surge noise that is generated from no fuse breakers (NFB), electromagnetic contactors (MC), relays (RA), solenoid valves, and induction motors. For surge killers, refer to the section to follow.

7.2.3 Attaching surge killers to control equipment

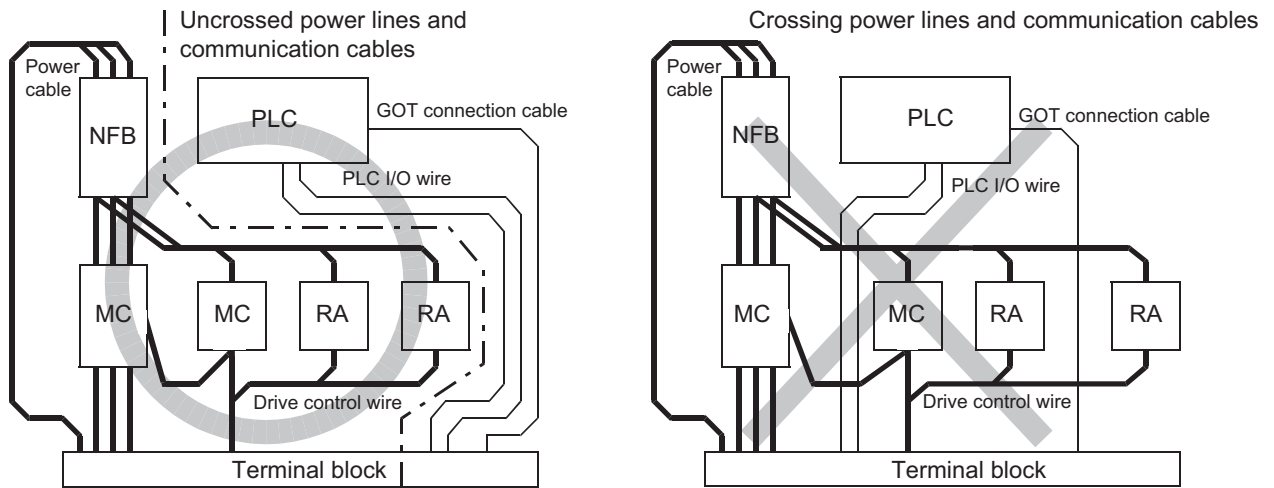

7.2.2 Outside the panel

To pull the power line and communication cable out of the panel, make two pullout holes away from each other and pull the cables through.

Putting both cables through the same pullout hole will increase noise interference.

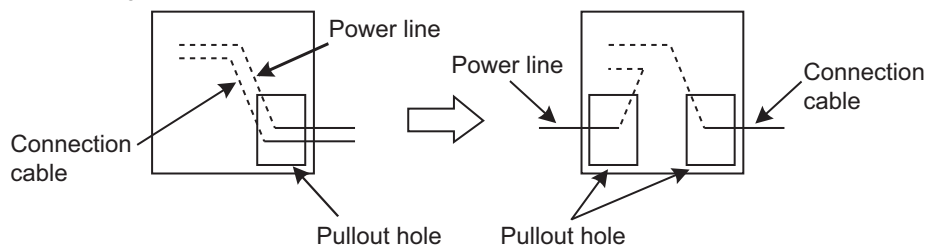

Keep the power line and communication cable inside the duct at least 100mm away from each other. If that is not possible, the use of a metal separator inside the duct can reduce noise interference.

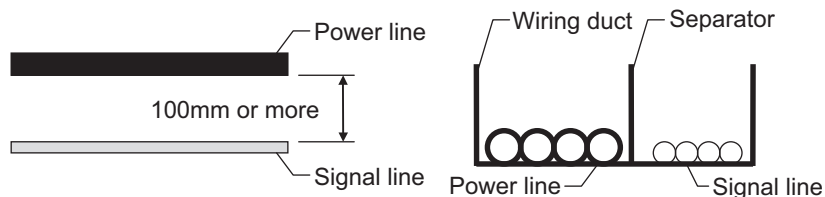

7.2.3 Attaching surge killers to control equipment

If communication errors happen in synch with the on/off signals from certain control equipment (referred to as "load" hereafter) such as no fuse breakers, electromagnetic contactors, relays, solenoid valves, and induction motors, surge noise interference is suspected.

If this problem happens, keep the ground cable and communication cable away from the load.

If that is not possible, an installation of a surge killer will help reduce noise interference.

Place the surge killer as close to the load as possible.

Remedy for AC inductive load

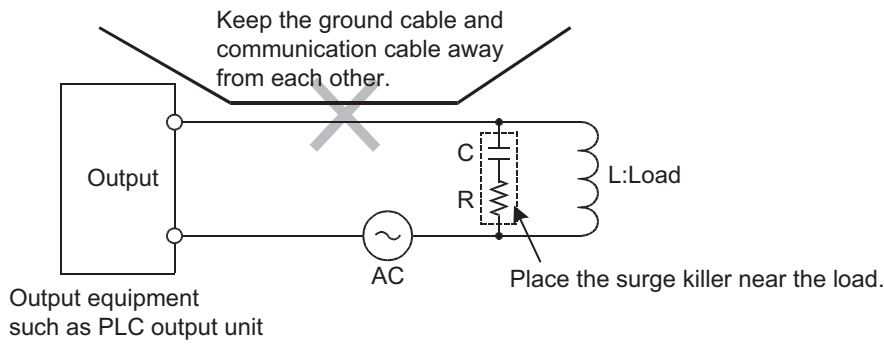

Remedy for DC inductive load

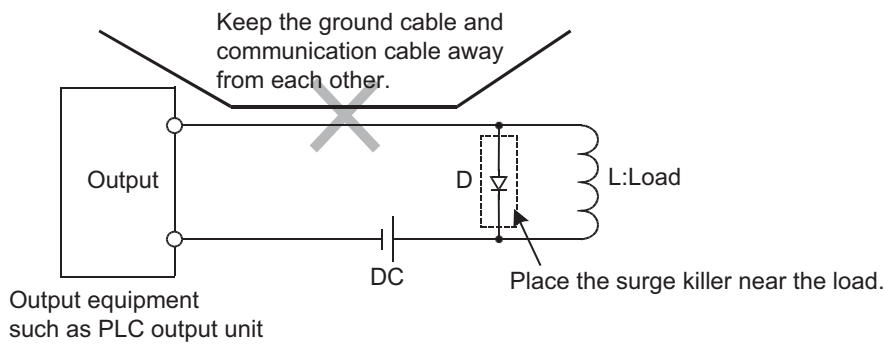

8. OPTION

8.1 SD Card

The SD card is used to transmit the OS or project data and to save the data of the alarm history function. For details, refer to the following.

 13. FILE DISPLAY AND COPY (PROGRAM/DATA CONTROL)

8.1.1 Applicable SD card

The following SD cards are applicable for GOT.

Model name	Description
L1MEM-2GBSD	SD memory card 2GB
L1MEM-4GBSD	SDHC memory card 4GB
-	Commercially-available SD card*1

*1 Some models with the operations checked by our company are usable. For the operation-checked models, refer to "Operation Check Results of Third Party SD Cards on GT14 Model" (Hime-T-P-0089) separately available, or contact your local distributor.

8.1.2 Installing and removing procedures of the SD card

Install/remove the SD card with the power supply of GOT is OFF or SD card access switch is "OFF".

■ Installing

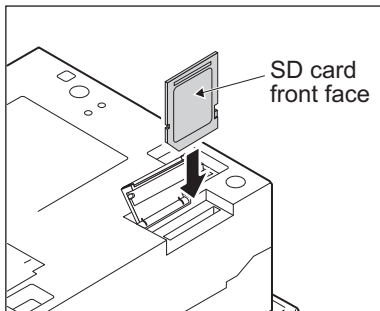
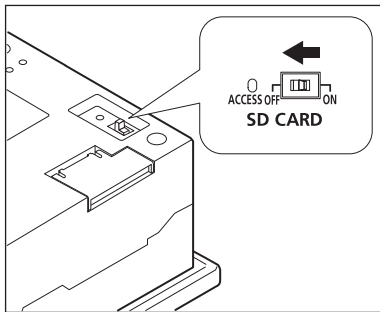

1. Set the SD card access switch of the GOT to "OFF", and make sure that the SD card access LED turns off. When the SD card access LED turns off, the SD card can be installed even during the GOT power on.
2. Insert the SD card into the SD card interface with its front side (nameplate side) outside.
3. Turn the SD card access switch on. After the SD card access switch is turned on, the SD card can be used.

■ Removing

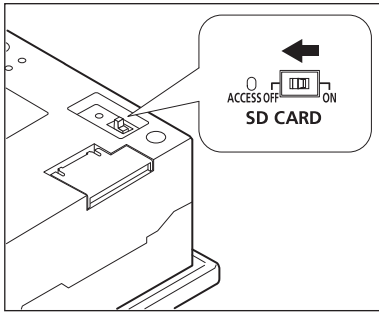

1. Set the SD card access switch of the GOT to "OFF."
Make sure that the SD card access LED turns off.
When the SD card access LED turns off, the SD card can be installed or removed even during the GOT power on.

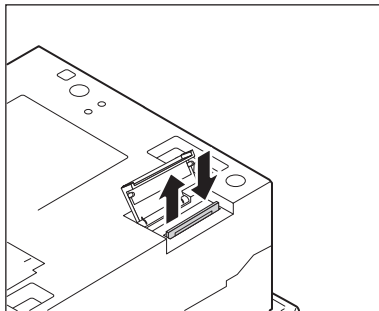

2. Push-in the SD card once and leave your finger, then remove the SD card.

POINT

Precautions for removing the SD card

- (1) While the SD card access LED is on, do not install/remove the SD card or power off the GOT.
To do so may cause data corruption or malfunction.
- (2) When ejecting the SD card, support it by hand since it may pop out.
Failure to do so may cause a fall of the SD card leading to failure or damage of the card.

8.2 USB Memory

The USB memory is used to transmit the OS or project data and to save the data of the alarm history function. For details, refer to the following.

 13. FILE DISPLAY AND COPY (PROGRAM/DATA CONTROL)

8.2.1 Applicable USB memory

The following USB memory is applicable for GOT.

Model name	Description
-	Commercially-available USB memory*1

*1 Some models with the operations checked by our company are usable.
For the operation-checked models, refer to "List of valid devices applicable for GOT1000 series" (T10-0039) separately available, or contact your local distributor.

8.2.2 Installing and removing procedures of the USB memory

When USB memory is accurately inserted to the USB interface, the GOT automatically recognizes it. For removing methods of the USB memory, refer to the following.

 13.2.9 USB device status display

8.3 Battery

The battery backs up clock data and data stored in the built-in RAM (D drive) including alarm history, recipe data, time action setting value, advanced alarm, advanced recipe, logging, hard copy, and SRAM user area. A battery is installed to GT14 when GT14 is shipped from the factory.

8.3.1 Applicable battery

The following battery is applicable for GT14.

Model name	Description
GT11-50BAT	Battery for clock data, alarm history, recipe data, time action setting value, advanced alarm, advanced recipe, logging, hard copy, and SRAM user area backups

8.3.2 Battery specifications

The following describes the battery specifications.

Item	Specifications
Model name	GT11-50BAT
Type	Manganese dioxide lithium primary battery
Initial voltage	3.0V
Life	Approx. 5 years (Operating ambient temperature of 25°C)
Application	For clock data, alarm history, recipe data, time action setting value, advanced alarm, advanced recipe, logging, hard copy, and SRAM user area backups

POINT

For the battery directive in EU member states, refer to the following.

 17.4 ■ Handling of Batteries and Devices with Built-in Batteries in EU Member States

POINT

Battery life and replacement time

- (1) Battery life reference: Approx. 5 years (Operating ambient temperature of 25°C)
Battery replacement time reference: 4 to 5 years
The battery is susceptible to natural discharge. Order one when necessary.
- (2) Check if the battery condition is normal within the utility.
For details of battery status display, refer to the following.

 11.1 Display Setting

8.3.3 Battery replacement procedure

Replace battery periodically at intervals of 4 to 5 years as reference.

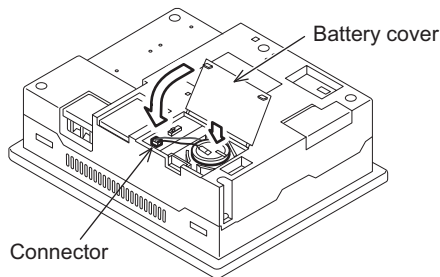
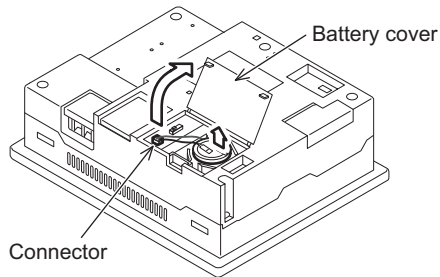

1. Turn the GOT power off.
2. Open the battery cover of the GOT.
3. Remove the old battery from the GOT.
4. Disconnect the old battery connector and insert the new battery connector within 30s.
5. Install a new battery to the GOT and close the battery cover.
6. Turn the GOT power on.
7. Check if the battery condition is normal with the utility.
For details of battery status display, refer to the following.
☞ 12. CLOCK SETTINGS AND BATTERY STATUS DISPLAY (TIME SETTING AND DISPLAY)

8.4 Protective Sheet

The protective sheet is used to protect the operation surface from damage or dirt when the touch key of GOT display section is operated.

For the GOT, the protective sheet is attached for transportation. (It is different from the one described in this chapter.)

8.4.1 Applicable protective sheet

Product name	Model name	Description	
Protective sheet	GT14-50PSCB	5.7" protective sheet	Clear 5 sheets
	GT14-50PSCB		Antiglare 5 sheets
	GT14-50PSCW		Clear (Frame: white) 5 sheets
	GT14-50PSGW		Antiglare (Frame: white) 5 sheets

8.4.2 Installing procedure

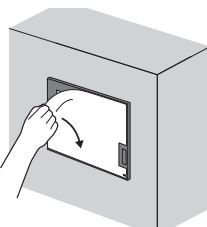
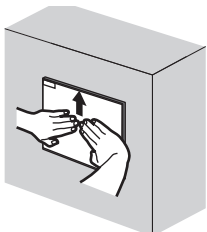
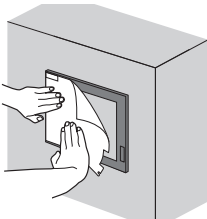
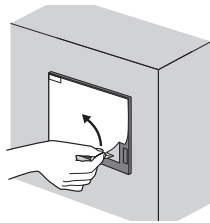

1. If the protective sheet has been already attached to the GOT, remove the old one from the GOT display section holding the lower right corner.
If the protective sheet for transportation is attached to the GOT, remove it too.
2. Remove the release paper from the back of a new protective sheet. Do not remove the protective film.
3. Make sure to fit the sheet on the GOT without wrinkles or air between the sheet and the GOT.
4. Remove the protective film from the protective sheet.
When the user continues using the GOT with the protective film, the film may not be removed.

POINT

Replacement time of protective sheet

Check the status of the protective sheet visually by the daily inspection.

The visibility becomes worse when there is too much dirt and cracks, causing malfunction. Proceed replacement promptly.

8.5 Protective Cover for Oil

Use of the protective cover for oil improves waterproof property, oil resistance, and chemical resistance of the GOT.

8.5.1 Applicable protective cover for oil

The following protective cover for oil is applicable for GT14.

Product name	Model name	Description
Protective cover for oil	GT05-50PCO	5.7" protective cover for oil

8.5.2 Installing procedure

POINT

Before attaching protective cover for oil

A protective film is attached on the display area when the GOT is shipped. Make sure to remove the protective film before attaching the protective cover for oil.

For attaching the protective cover for oil to the GOT already mounted on the control panel, follow the procedures as below.

- Remove the GOT from the control panel.
Make sure to externally shut off all phases of the power supply and remove all cables from the GOT in advance.
- Clean dirt off surfaces of the GOT and control panel.

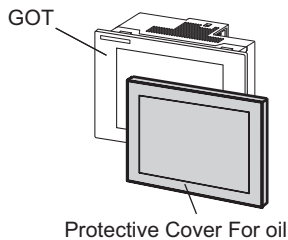

Protective Cover For oil

Please do not pull the oil cover more than the necessity, and do not bend it extremely. The seat part and the rubber part in the display part might flake off.



The corner is hung.

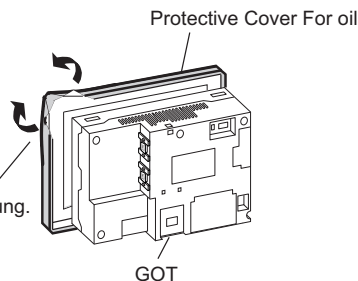

GOT

1. Position the POWER LED frame of the cover to the POWER LED on the GOT front face, and the direction of the cover is decided.
2. One corner of the cover is pulled outside, and it hangs on the corner of the front panel of GOT.

The corner on the left is hung and the oil cover is hung from A side to D side on the starting point sequentially.

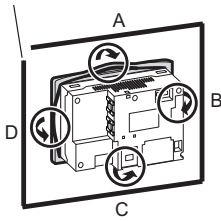

Make sure that corners of protective cover for oil match those of GOT front.

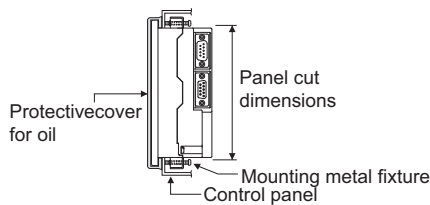

3. The oil cover was hung and the edge of the oil cover is sequentially obtained and obtain the oil cover to cover rubber packing parts in the back of GOT of the front panel.
(From A side to D side, in the direction of the arrow)

4. Please confirm all surroundings. Check whether the rubber packing is fitted correctly into the groove on the under side of the GOT front panel, and then whether the protective cover for oil securely covers the rubber packing part to prevent invasion of liquids into the board.

5. Mount the GOT onto the control panel. When the control panel is dirty, clean the control panel. The panel cutting dimensions and mounting screw tightening torque with the protective cover for oil are the same as those without the cover.

POINT

(1) Precautions on installation

Tighten the mounting screws within the specified torque range.

- Specified torque range (0.3 to 0.5N·m)

Undertightening can cause a drop. Also, undertightening can disable waterproof or oil proof effect.

Overtightening can cause a drop, short circuit or malfunction due to the damage of the GOT or the mounting fixtures. Also, "distortion" of the GOT or the panel may disable waterproof or oil proof effect.

(2) Precautions for protective cover for oil

- The protective cover for oil is a consumable product.

Check the cover for scratch, damage or dirt at regular intervals, and replace with new one if necessary.

- Do not push the protective cover for oil with pointed tools, including mechanical pencils and screwdrivers. Doing so causes scratches and damages of the cover.
- Do not clean the protective cover for oil with bleaches, thinners, organic solvents, corrosive chemicals, and others. Doing so causes changes in shape and color of the cover.
- When the protective cover for oil is attached to the GOT, do not stretch and bend the cover too much. Doing so may cause a separation between the sheet and rubber.
- Do not place or use the protective cover for oil in direct sunshine.
- When the protective cover for oil gets dusts, wipe the dusts off with a damp cloth.
- Do not do a frequent detaching the protective cover for oil.
It causes deterioration in the oil performance and the medicine performance.
- It is not the one to guarantee all customer's environments.
Moreover, it is not likely to be able to use it in the environment to which oil splashes for a long time and the environment with which Oilmist is filled.

8.6 USB Environmental Protection Cover

The USB environmental protection cover protects the USB connector on the front face of GOT from dust, water, and oil. The GOT is installed with the USB environmental protection cover at factory shipment. Replace when damage and deterioration are caused.

8.6.1 Applicable USB environmental protection cover

The following USB environmental protection cover is applicable for GT14.

Product name	Model name	Description
USB environmental protection cover	GT14-50UCOV	Environmental protection cover for USB interface on the main unit front panel (conforming to IP67f)

8.6.2 Installing procedure

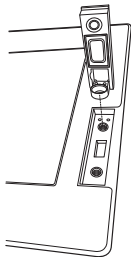
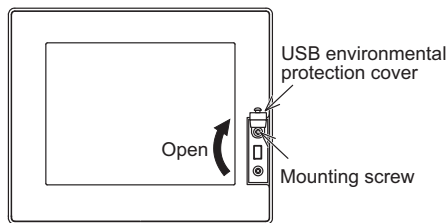

1. Turn the GOT power off.
2. Disconnect the USB cable from the GOT if one is connected.
3. Open the USB environmental protection cover equipped with the GOT and remove the mounting screws.
4. Remove the old USB environmental protection cover from the GOT to replace it with the new USB environmental protection cover.
5. Fix the projection of the new USB environmental protection cover to be fitted into the hole of the GOT, tighten the mounting screw in the specified torque range, then install it to the GOT. Tighten the mounting screws in the specified torque range. Not doing so may cause a damage or a drop. Specified torque range: 0.36 to 0.48N·m

Mounting screw
M3 x 6 pan head screw

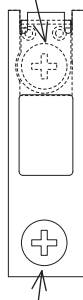

M3 x 6 pan head screw

POINT

Precautions when the USB environmental protection cover is opened

Environmental protective structure of USB interface is "IP2X" when the USB environmental protection cover is opened.

8.7 Stand

Stand is used to fix the GOT to standing status in order to debug the monitor screen data easily.

8.7.1 Applicable stand

The following stand is applicable for GT14.

Product name	Model name	Description
Stand	GT05-50STAND	Stand for 5.7" (for GOT1000 series)

8.7.2 Installing procedure

Adjust to
45°, 55°, 65° or 75°.

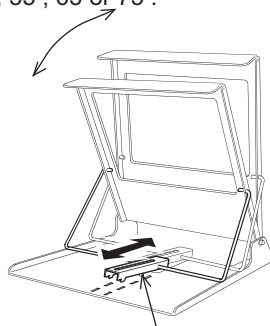

Angle adjusting fitting

1. Adjust the mounting angle of GOT with the angle adjusting fitting of the stand.

GOT
mounting face

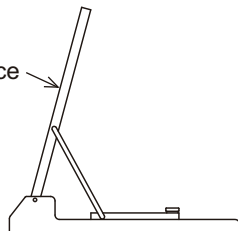

2. Put the GOT into the stand from the stand front side and fix it using the mounting fixtures.
For how to mount the GOT, refer to the following.
☞ 6.5 Installation Procedure
For a detail of the stand, refer to the following.
☞ GOT1000 STAND User's Manual

8.8 Connector Conversion Adapter

GT10-9PT5S type connector conversion adapter enables an easy crossover wiring for the multi-drop-connected GOTs. For the wiring between the connector conversion adapter and the controller, refer to the following manual.

 GOT1000 Series Connection Manual (Mitsubishi Products) for GT Works3

8.8.1 Applicable connector conversion adapter

The following connector conversion adapter is applicable.

Model name	Description
GT10-9PT5S	For GOT multi-drop connection

8.8.2 Installing procedure of connector conversion adapter

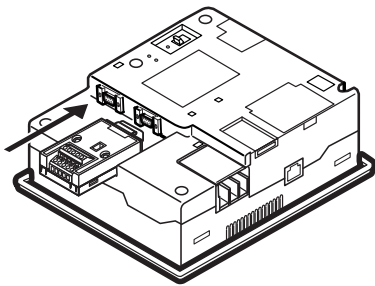

1. Turn the GOT power off.
2. Connect the connection conversion adapter to the RS-422/485 interface on the GOT.

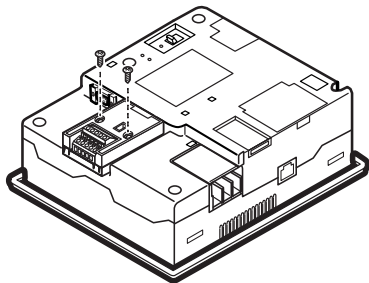

3. Fix the connection conversion adapter to the GOT using the provided M3 tapping screws. Tightening torque: 0.3 to 0.6 N·m

8.9 Serial Multi-Drop Connection Unit

8.9.1 Serial multi-drop connection unit

GOT serial multi-drop connection is a communication method for 1:N communication by connecting multiple GOTs to one PLC, using the GT01-RS4-M serial multi-drop connection unit. For details of GOT multidrop connection, refer to the following.

 GOT1000 Series Connection Manual (Mitsubishi Products) for GT Works3

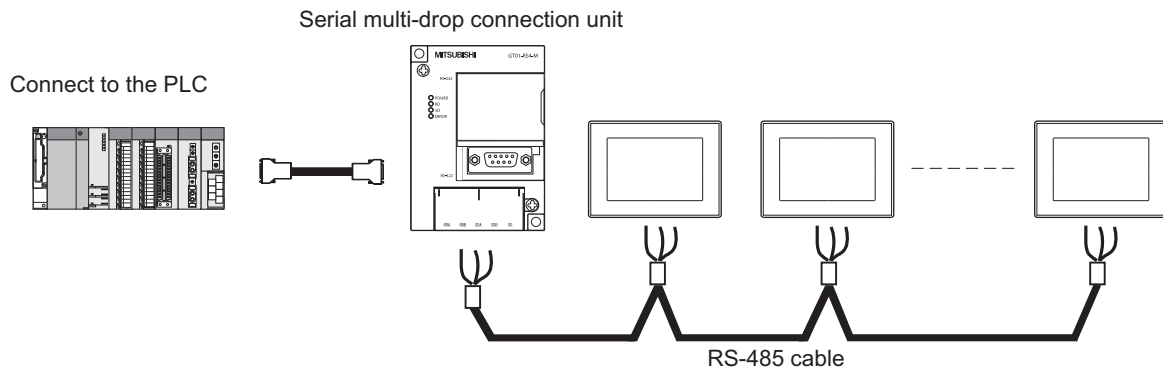

8.9.2 Applicable serial multi-drop connection unit

The following serial multi-drop connection unit is applicable.

Model name	Description
GT01-RS4-M	For GOT multi-drop connection

8.9.3 Installation

■ Installed with DIN rail

Install the serial multi-drop connection unit with its hook (1 place) using the DIN rail.

- Applicable DIN rail DIN46277 (width: 35mm)
(Install the DIN rail with screws at intervals of 150mm.)

■ Directly installed to panel

Install the serial multi-drop connection unit to the panel using 4.5mm holes (2 places).

8.9.4 Parts name

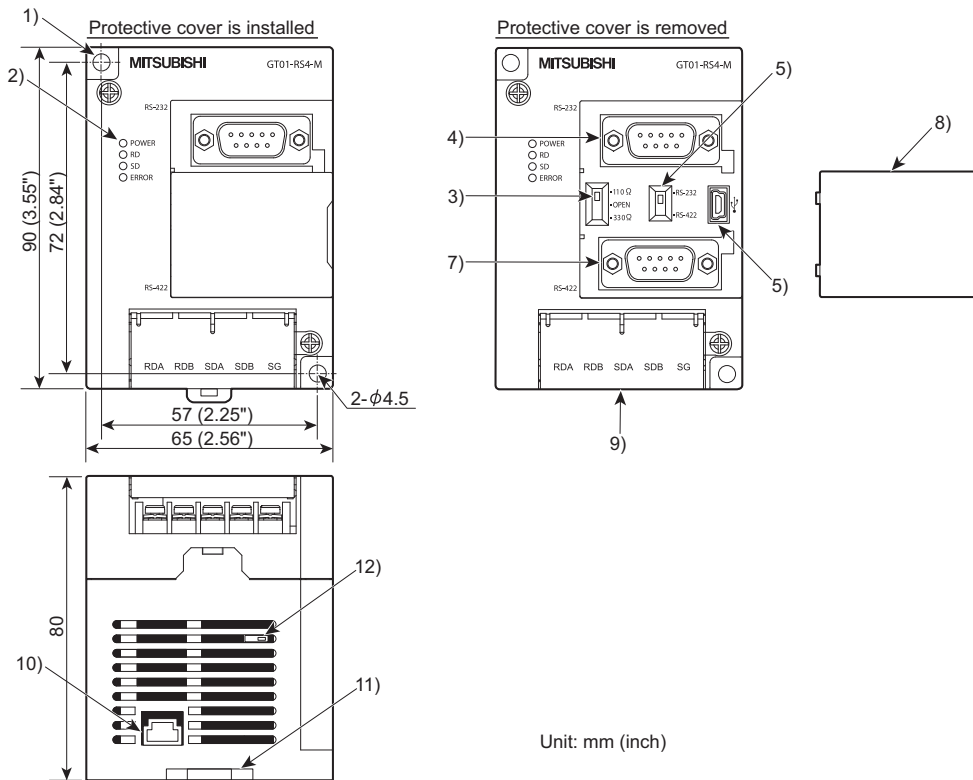

No.	Name	Description	
1)	Installation hole for the main unit	Installation hole (2-Φ4.5)	
2)	LED	POWER	Lit in green when the power is properly supplied.
		SD	Lit in green when the data is being sent to PLC.
		RD	Lit in green when the data is being received from PLC.
		ERROR	Lit or blinking depending on the status.
3)	Terminating resistor selector switch	Can be selected among 110Ω, OPEN, and 330Ω (set to "OPEN" by default).	
4)	Connector for the PLC communication	D-Sub 9pin (Male), for RS-232 connection	
5)	Connector selection switch for the PLC communication	Switch for selecting RS-422 or RS-232 (set to "RS-422" by default)	
6)	USB port	For connecting a PC (for changing the communication driver)	
7)	Connector for the PLC communication	D-Sub 9pin (Female), for RS-422 connection	
8)	Protective cover	Protects unused D-sub connector, USB port, and switches.	
9)	Terminal block for the serial multi-drop communication	Terminal block 5-pin (with a protective cover) M3 Tightening torque 0.5 to 0.6N•m	
10)	Power supply connector	24VDC power supply connector insertion point (A dedicated cable is included.)	
11)	Slider for installing the DIN rail	-	
12)	Mode selection switch (Slide switch)	Do not operate. (Set to right by default. When set to left, the module does not operate normally.)	

8.9.5 Caution for compliance with EMC Directive

Please use the serial multi-drop connection unit while installed in conductive shielded control panels. Programmable logic controllers are open-type devices that must be installed and used within conductive control panels. Please secure the control panel lid to the control panel (for conduction). Installation within a control panel greatly affects the safety of the system and aids in shielding noise from the serial multi-drop connection unit.

8.10 Panel-Mounted USB Port Extension

GT14-C10EXUSB-4S panel-mounted USB port extension is a waterproof extension cable of the USB. It is used to pull out the USB interface (host) on the back of GT14 to the surface of the control panel.

8.10.1 Applicable panel-mounted USB port extension

The following panel-mounted USB port extension is applicable for GT14.

Model name	Description
GT14-C10EXUSB-4S	Panel-mounted USB port extension

8.10.2 Parts name

The following shows the parts name of panel-mounted USB port extension.

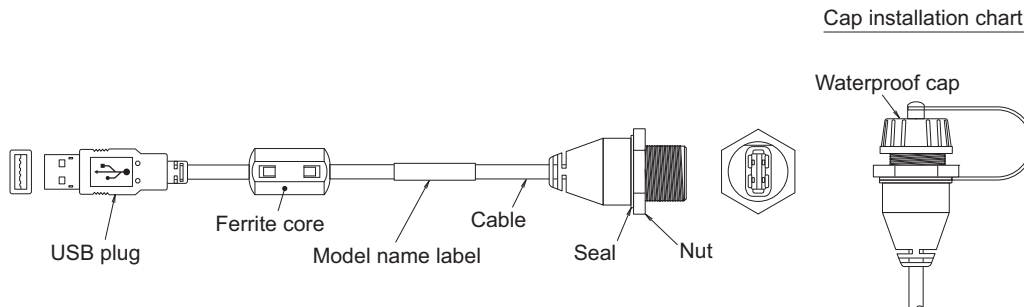

8.10.3 Installing procedure

■ Installed to panel

Install the panel-mounted USB port extension as follows with attention to a curve or a distortion of waterproof cap, seal, and nut.

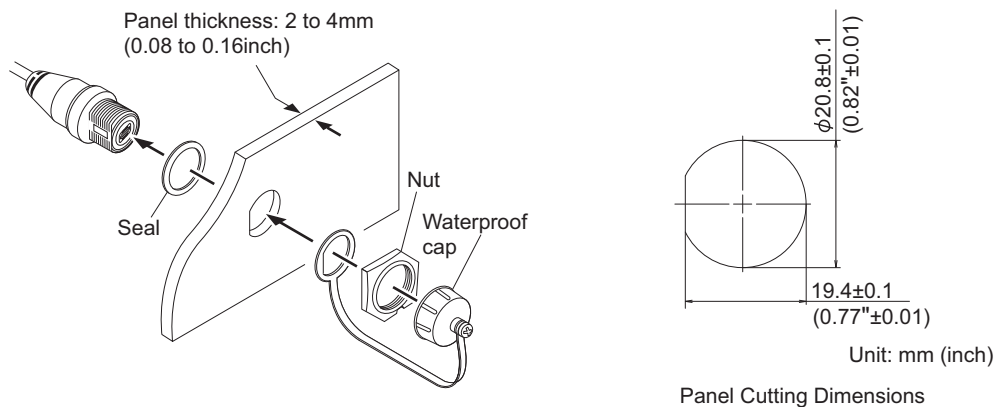

- The panel thickness is 2.0 to 4.0mm.
- For panel-mounted USB port extension, the panel surface with waterproof cap is compatible with IP67f.
- Tightening torque of nut is 0.294 to 0.343N•m. Overtightening or undertightening may disable the waterproof effect.
- Tighten the waterproof cap properly when the cable is not used.

■ Precautions on installing the panel-mounted USB port extension

- (1) Run power lines, servo amplifier drive wires, and panel-mounted USB port extensions so that they do not cross each other.
- (2) Install the panel-mounted USB port extension away from noise sources such as equipment.
- (3) Do not twist, bend at a sharp angle or a right angle, and stretch the panel-mounted USB port extension since the cable may be broken.
- (4) Install it while considering the following control panel inside dimensions.
 - Dimension between the back of the GOT and structures

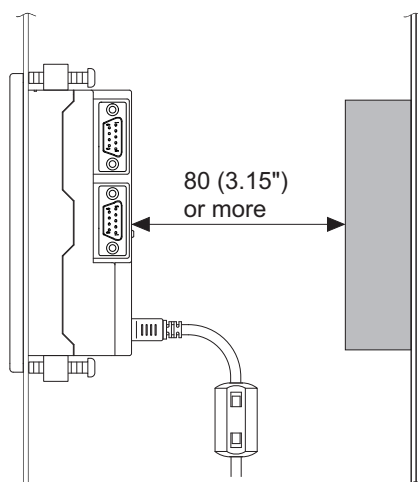

- Dimension of the protruding cable

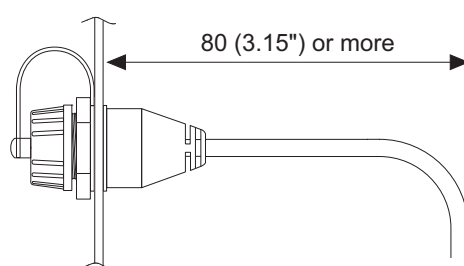

- (5) Insert the USB plug part of the tip of the panel-mounted USB port extension securely to the USB port of the GOT.
Since the USB plug part may be inserted loosely or unplugged by power of vibrations, impacts, or pulling, fix the cable to the structures inside the panel or the preventive hole from removing for the USB cable of the GOT main unit by using the banding band or others.

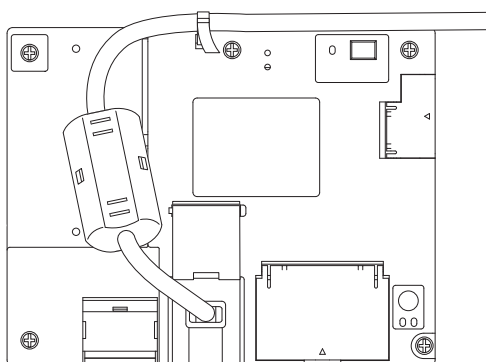

- (6) Use the product after checking that the functions and performances operate correctly.

8.11 RS-232/485 Signal Conversion Adapter

GT14-RS2T4-9P type RS-232/485 signal conversion adaptor enables conversion of RS-232 communication interface to RS-485 communication interface.

For the wiring between the RS-232/485 signal conversion adapter and the controller, refer to the following manual.

 GOT1000 Series Connection Manual (Mitsubishi Products) for GT Works3

8.11.1 Applicable RS-232/485 signal conversion adapter

The following RS-232/485 signal conversion adaptor is applicable.

Model name	Contents
GT14-RS2T4-9P	For GOT multi-drop connection, multi-channel function connection, temperature controller connection, and MODBUS(R)/RTU connection

8.11.2 Installing procedure of RS-232/485 signal conversion adapter

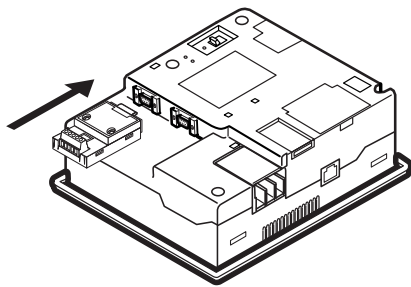

1. Turn the GOT power off.
2. Connect the RS-232/485 signal conversion adapter to the RS-232 interface on the GOT.

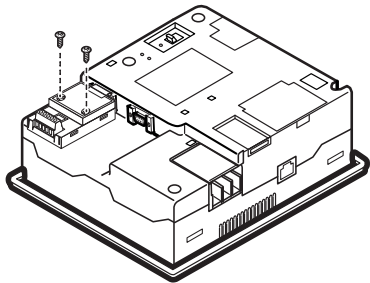

3. Fix the RS-232/485 signal conversion adapter to the GOT using the provided M3 tapping screws.
Tightening torque: 0.3 to 0.6 N·m

POINT

5V power supply

- (1) To use the RS-232/485 signal conversion adaptor, select [Communication Setting] → [Communication Setting] → [5V power supply] → [Yes] on the utility screen of GT14.
5V power supply is a function that supplies electrical power to the RS-232/485 signal conversion adaptor. It cannot be used in other controllers. For details on the 5V power supply, refer to the following.

 10.1.3 Communication setting contents

- (2) [5V power supply] can be set with the GT 14 hardware version B or later.
In the hardware version A, since 5V power is always supplied, this setting operation is invalid.
- (3) To use the RS-232/485 signal conversion adaptor, select CoreOS of version V05.28.00AP or later and the standard OS of version V05.28.00 or later for GT14. For details on the version confirmation, refer to the following.

 13.1.2 OS version confirmation

9. UTILITY FUNCTION

Utility is a function, which carries out connection of GOT and PLC, screen display and operation method settings, program/data control and self-check etc.

For the utility function list, refer to the following.

☞ 9.2 Utility Function List

9.1 Utility Execution

For utility execution, utility has to be displayed by installing BootOS and Standard monitor OS in the C drive (Flash memory).

There are following three types for the installing Standard monitor OS methods.

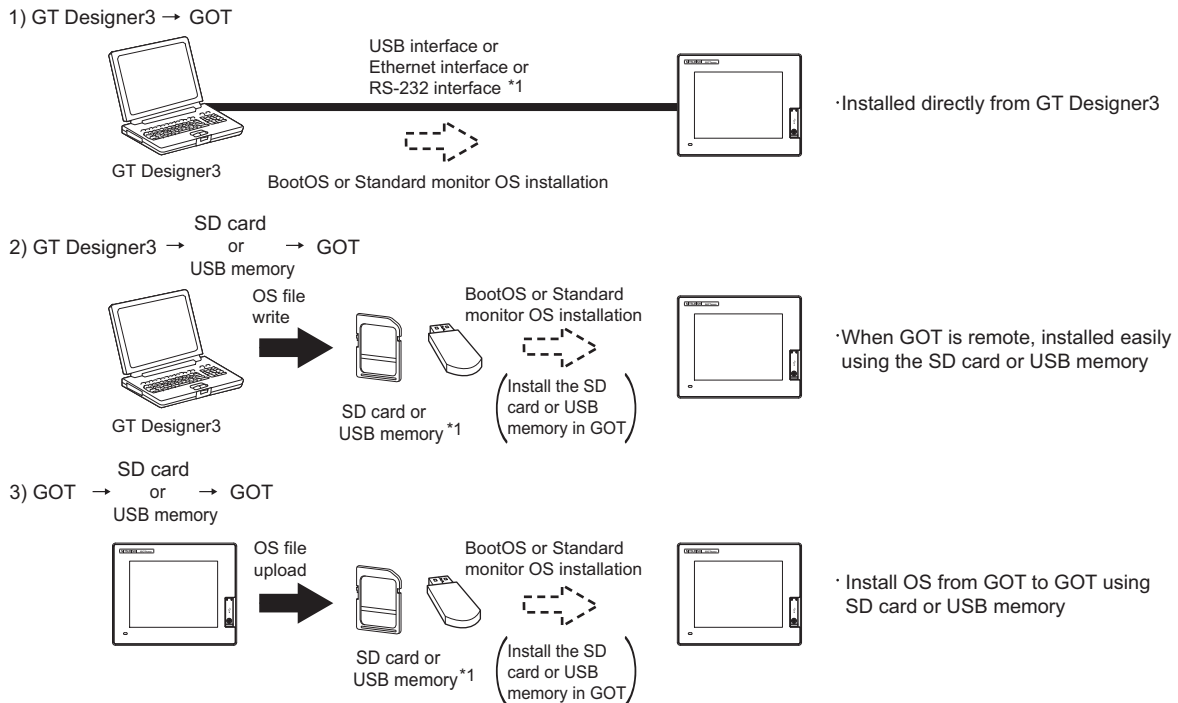

*1 When installing the BootOS and standard monitor OS, standard monitor OS has to be installed in GOT in advance.

For the installation which uses GT Designer3, refer to the following.

☞ GT Designer3 Version1 Screen Design Manual (Fundamentals)

For the installation which uses GOT, refer to the following.

☞ 16. INSTALLATION OF COREOS, BOOTOS AND STANDARD MONITOR OS

9.2 Utility Function List

The items in the following list can be set/operated on the utility screens.

Item		Functions overview	Reference
Communication setting	Communication setting	Assigning channel numbers and communication drivers to communication interfaces	10.
		Setting communication parameters Setting or deleting sequence program protection key words, canceling sequence program protection status (When connecting to FX series CPU)	10.
		Setting whether to supply 5V power or not ^{*1*2}	
	Ethernet setting	Displaying the contents of Ethernet setting, changing the host	10.
GOT setup	Display	Switching message languages	11.1
		Setting the startup screen display time and screen saving time	
		Setting the backlight to ON or OFF during screen saving	
		Setting the battery alarm display to ON or OFF	
		Adjusting brightness and contrast	
		Inverting colors	
	Operation	Setting the buzzer volume and window move buzzer	11.2
		Setting the key sensitivity and key reaction speed	
		Changing security levels	11.2.4
		Setting the utility call keys	11.2.5
		Adjusting the touch panel	11.2.6
		Setting the USB mouse and keyboard	11.2.7
	Transparent mode	Setting the channel No. to be used for the communication for the FA transparent function	11.3
	Backup/restoration	Setting the storage locations for backup data and backup settings, and setting the maximum number of backup data	11.4
		Trigger backup settings	
Setting the CPU No. setting at backup to "YES" or "NO"			
Behavior of duplicate IPs	Setting the GOT operation when a device with the same IP address as that of the GOT is added to the network afterwards	11.5	
Time setting & display	Selecting a base clock	12.	
	Displaying the clock current time		
	Setting the clock current time		
	Displaying the battery status		
Program/data control	OS information	Installing or uploading OS, displaying OS property, checking OS data	13.2.1
	Alarm information	Deleting and copying alarm log files Converting alarm log files in G1A format → CSV or TXT format	13.2.2
	Project information	Downloading, uploading, deleting or copying project files, displaying project file property, checking project file data	13.2.3
	Hard copy information	Deleting or copying hard copy files, changing hard copy file names	13.2.4
	Advanced Recipe information	Converting advanced recipe files in G1P format → CSV or TXT format Converting CSV or TXT format → Advanced recipe files in G1P format Deleting, copying or moving advanced recipe files, creating a new advanced recipe file Deleting or moving advanced recipe folders, changing advanced recipe folder names, creating a new advanced recipe folder Writing, reading or matching record data and deleting device values with the advanced recipe record list	13.2.5
	Logging information	Converting logging files in G1L format → CSV or TXT format Deleting, copying or moving logging files, changing logging file names Deleting logging folders or creating a new logging folder	13.2.6
	Memory card format	Formatting a SD card or USB memory, internal SRAM	13.2.7
	Memory information	Displaying the available memory of the GOT	13.2.8
	USB device status display	Displaying the status of USB device	13.2.9
	SRAM control	Confirming the SRAM user area usage, backing up or restoring the data in the SRAM user area, and initializing the SRAM user area	13.2.10
	GOT data package acquisition	Copying the OS, special data, and project data to a SD card or USB memory	13.2.11

Item		Functions overview	Reference	
Debug & self check	Debug	System monitor	Device monitor of PLC, test function, present value change of the buffer memory monitor and the buffer memory of intelligent module	14.1.1
		A list editor	Sequence program and parameter change of ACPU	14.1.2
		FX list editor	Sequence program and parameter change of FX PLC	14.1.3
		Backup/restoration	Executing backups, executing restorations, and deleting backup data	14.1.4
	Self check	Memory check	Memory check of A drive, C drive, D drive, and E drive	14.2.1
		Display check	Drawing check	14.2.2
			Font check	14.2.3
		Touch panel check	Touch panel operation check	14.2.4
		I/O check	Connected target confirmation, self-loopback check	14.2.5
		Ethernet status check	Sends a ping to check the Ethernet connection status	14.2.6
	System alarm display	Displaying GOT errors and CPU errors, resetting GOT errors	14.3	
GOT start time	Displaying GOT start date and time, current time, accumulated operating hours	14.4		
Clean	Clean	Displaying the screen for cleaning the display	15.	

*1 Do not use this function for other than 5V power supply to the RS-232/485 signal conversion adaptor.

 7.11 RS-232/485 signal conversion adapter

*2 [5V power supply] can be set with the GT 14 hardware version B or later. In the hardware version A, since 5V power is always supplied, this setting operation is invalid.

9	UTILITY FUNCTION
10	COMMUNICATION INTERFACE SETTING (COMMUNICATION SETTING)
11	DISPLAY AND OPERATION SETTINGS (GOT SET UP)
12	CLOCK SETTINGS AND BATTERY STATUS DISPLAY (TIME SETTING AND DISPLAY)
13	FILE DISPLAY AND COPY (PROGRAM/DATA CONTROL)
14	GOT SELF CHECK (DEBUG AND SELF CHECK)
15	CLEANING DISPLAY SECTION (CLEAN)
16	INSTALLATION OF COREOS, BOOTOS AND STANDARD

9.3 Utility Display

To display setting screens for each utility, the main menu must be displayed first.

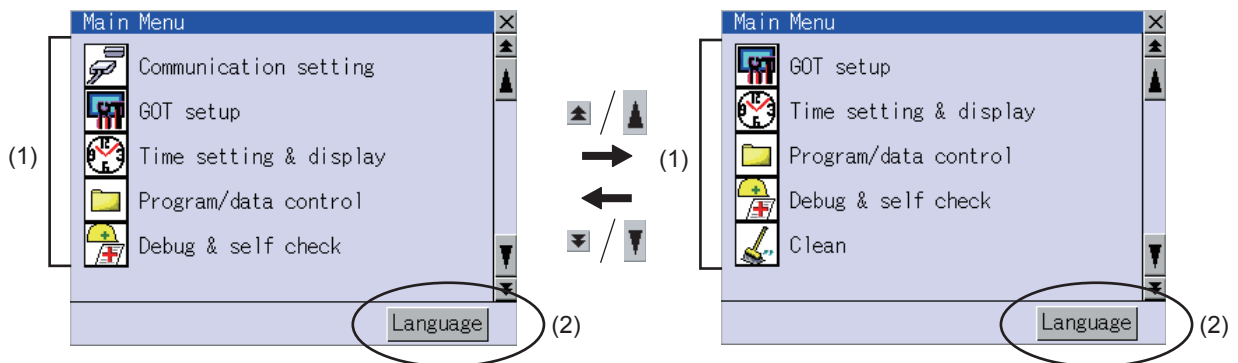

(1) Main menu

The menu items that can be selected from the GOT utility are displayed.

Touching a menu item in the main menu displays the setting screen or following selection screen for the item.

(2) System message switch button

This button switches the language used for the utility screen and system alarms.

Touching the [Language] button displays the Select Language screen.



1. Touch the button of a desired language and then [OK] button, and the language is selected.

2. Touching the [x] button restarts the GOT and the language of the utility is switched to the selected one.

POINT

When starting the GOT without selecting any language or the selected language and the installed fonts are not matched.

The following screen is displayed.

Touching the button of a desired language restarts the GOT and the language is switched to the selected one.



HINT

(1) Selectable languages

The system message switch button is displayed only for the selectable languages.

The selectable languages differ depending on the fonts installed in the GOT.

For the relation between the selectable languages and the fonts, refer to the following.

 GT Designer3 Version1 Screen Design Manual (Fundamental) 2.5 Specifications of Applicable Characters

(2) System language switching using the device

The system language can be switched using the system language switching device set with GT Designer3.

For the setting method of the system language switching device, refer to the following.

 GT Designer3 Version1 Screen Design Manual (Fundamental)
4.3 Language Switching Device Setting (GOT Environmental Setting: Language Switching)

9.3.1 Display operation of main menu

The following four types of operation can display the main menu.

(Display the main menu after installing the Standard monitor OS from GT Designer3 to the built-in flash memory of the GOT.)

- (1) When project data is undownloaded
After the GOT is turned on, a dialog box for notifying of absence of project data is displayed. After the dialog box is displayed, touch the OK button to display the main menu.

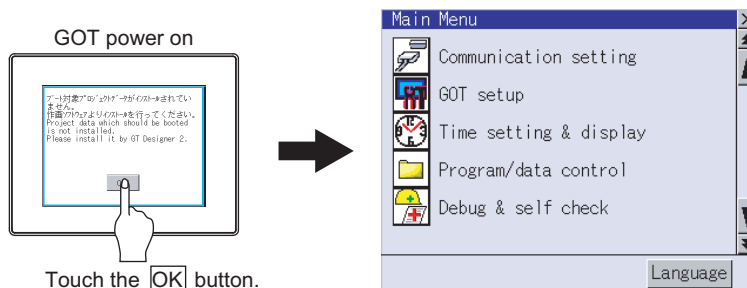

- (2) When touching menu call key
Touching the menu call key while user-created screen is displayed displays the main menu. The menu call key is set in the position on the GOT screen upper left corner at factory shipment.

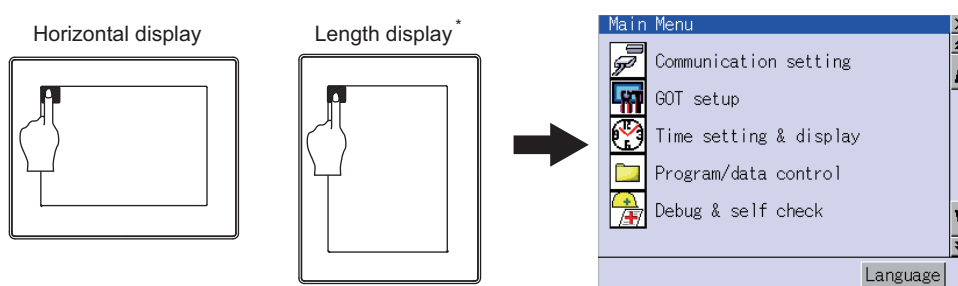

* The utility screen is a factory installed horizontal format screen that cannot be edited.

The menu call key can be set by the GOT utility or GT Designer3.

For menu call key setting, refer to the following.

 • 11.2.5 Utility Call Key Setting

- GT Designer3 Version1 Screen Design Manual (Fundamental)
4.9 GOT Display and Operation Setting (GOT Environmental Setting: GOT Setup)

POINT

- (1) Prohibited simultaneous 2-point presses
Do not touch 2 points or more on the GOT screen simultaneously. Touching 2 points or more simultaneously may activate a part other than the touched point.
- (2) Pressing time of the utility call key
When having set [Pressing time] of the menu call key setting screen to other than "0 (s)", keep pressing the touch panel for the period set to [Pressing time] or more before leaving the finger from the touch panel.
For menu call key setting, refer to the following.

 11.2.5 Utility Call Key Setting

- (3) When the utility call key is set to the zero point
Even when the utility call key is set to the zero point, you can display the main menu using either of the following two operations:
 - Pressing the special function switch set on the user-created screen
 - Keeping pressing the upper left corner while the [Booting.] message is displayed after powering up.

(3) When touching special function switch (utility)

Touching the special function switch (utility) while user-created screen is displayed displays the main menu. The special function switch (utility) can be set as a touch switch that is displayed on a user-created screen by GT Designer3.

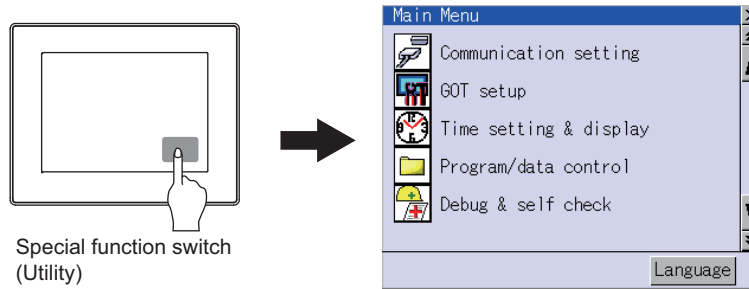

For the details of the special function switch, refer to the following.

 GT Designer3 Version1 Screen Design Manual (Functions)

(4) When powering ON the system

The [Booting.] message is displayed after powering up. After that, keep pressing the upper left corner to display the main menu.

If the upper left corner is pressed before the display of the [Booting...] message, the OS installation function starts. Therefore, press the upper left corner after the [Booting...] message is displayed.

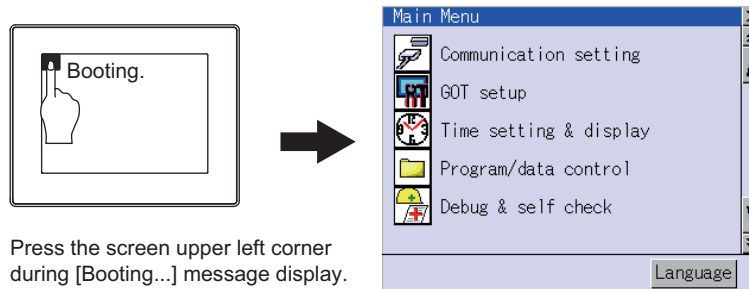

POINT

When limiting the display and operation of the utility

When limiting the display and operating users, set a password to the GOT using the GT Designer3. If a user tries to display the main menu of the utility, the password input screen is displayed.

For details on setting passwords, refer to the following.

 GT Designer3 Version1 Screen Design Manual (Fundamentals)

9.3.2 Utility basic configuration

The basic configuration of the screen is as follows.

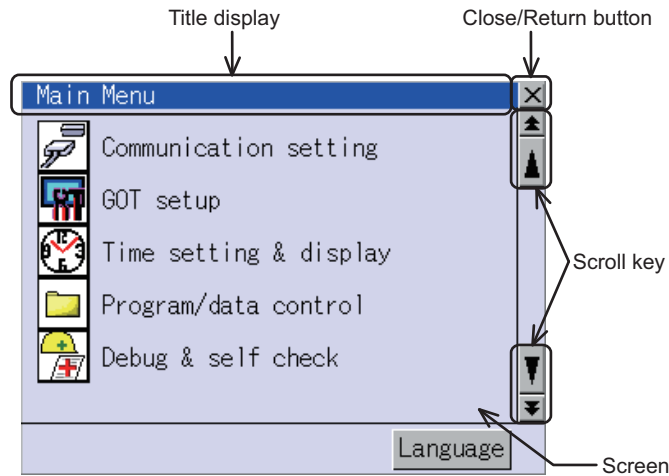

(1) Title display

The screen title name is displayed in title display part.

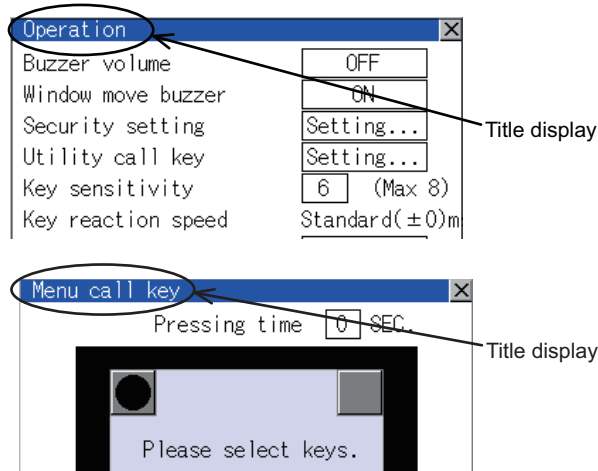

(2) Close/Return button

When a middle screen of the layers is displayed, if the [X] (Close/return) button in the right corner of screen is touched, returns to the previous screen.

If this button is touched when directly displayed from monitor screen, the screen is closed and returns to monitor screen.

(3) Scroll button

For screens in which the content does not fit on one screen page, there is a right or down scroll button on the screen.

▲ ▼ ◀ ▶ Scroll one line/column

▲ ▼ ◀ ▶ Scroll window

9.3.3 Basic operation of settings change

Change of setting value

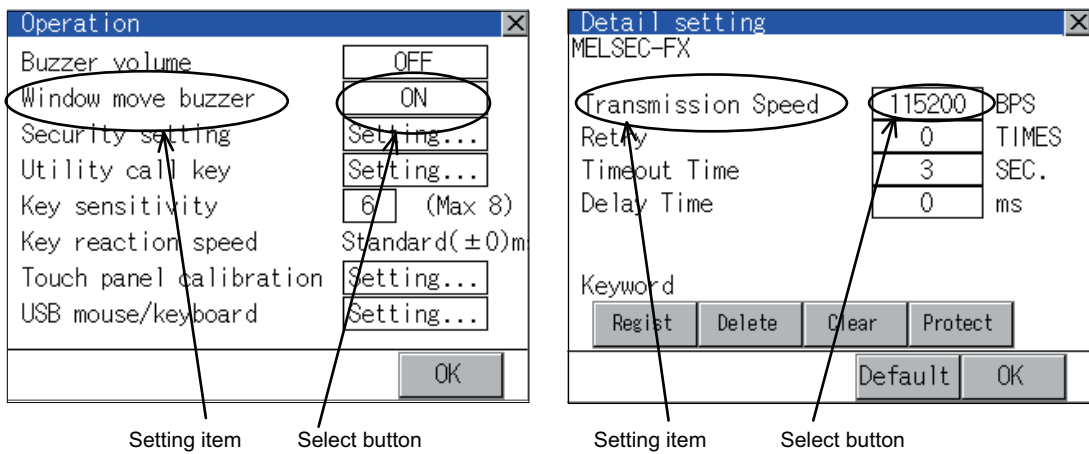

(1) Setting item, select button

Touch the select button to change the settings.
The setting methods differ depending on the setting items.
The following types of setting method are available.

(a) Switch the setting value.

Touch the button to switch the setting value as shown in ON  OFF.

(b) Enter the setting value with a keyboard.

It is a key for inputting the numerical value. Touching this button displays a keyboard on the GOT screen.
For the operation of keyboard, refer to the next page.

(c) Move to another setting screen.

Touching this button moves to another setting screen.

For the setting method of each setting item, refer to the setting operation of each setting screen.

(2) [OK] button, [Cancel] button, [x] (Close/Return) button

Reflect or cancel the changed settings.

(a) [OK] button

Touching this button reflects the changed settings.

(b) [Cancel] button

Touching this button cancels the changed settings and return to the previous screen.

(c) [x] (Close/Return) button

Touching this button closes the screen. Depending on the setting item, the GOT restarts.

If [x] button is touched without touching [OK] button, the following dialog box will be displayed.
(If the settings are not changed, the dialog box is not displayed.)

Operate following the message of the dialog box.

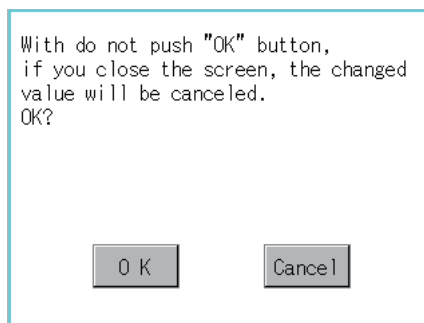

Keyboard operation

1. Touch the numerical value to be changed.
2. Keyboard for numerical input is displayed and cursor is displayed simultaneously.
The key board display position changes by the position of numerical value touched.
(At the time of numerical input, displayed in the position which will not interrupt the inputting.)



3. Input numeric with keyboard.
 - [0] to [9] Key: Input the numeric.
 - [Enter] Key: Completes numeric input and closes the keyboard.
 - [Cancel] Key: Cancels numeric input and closes the keyboard.
 - ◀ ▶ Key: Moves the cursor to the right or left side. (Available only if any selectable item is at the right/left side of the cursor.)
 - [Del] Key: [Del] key is used when canceling the input by 1 character.
 - [*] key and the key which is not mentioned do not function.
4. Touching [Enter] key completes numeric input and closes keyboard.

10. COMMUNICATION INTERFACE SETTING (COMMUNICATION SETTING)

In [Communication Setting], the communication interface names and the related communication channel, communication driver names display and channel numbers are set. Moreover, in [Communication Detail setting], the communication interface details are set. (Communication parameters setting)

Function	Description	Reference
Communication Setting	The setting contents of the communication interface can be checked or changed.	10-1
	Whether to supply 5V power or not can be set.	10-1
Ethernet setting	The contents of the Ethernet setting can be checked and the host can be changed.	10-15

10.1 Communication setting

10.1.1 Communication setting functions

Function	Description
Channel-Driver assign	Change the assignment of channel No. and communication driver name.
Assign Ethernet I/F	Change the assignment of channel No. and communication driver name of the device connected using the Ethernet interface.
Channel No. (Ch No.) setting	Set the channel numbers of the communication interface (Standard interface).
Communication parameters setting	Set communication parameters of communication devices.
5V power supply	Set whether to supply 5V power or not when the RS-232/485 signal conversion adaptor is used.

10.1.2 Display operation of Communication Setting

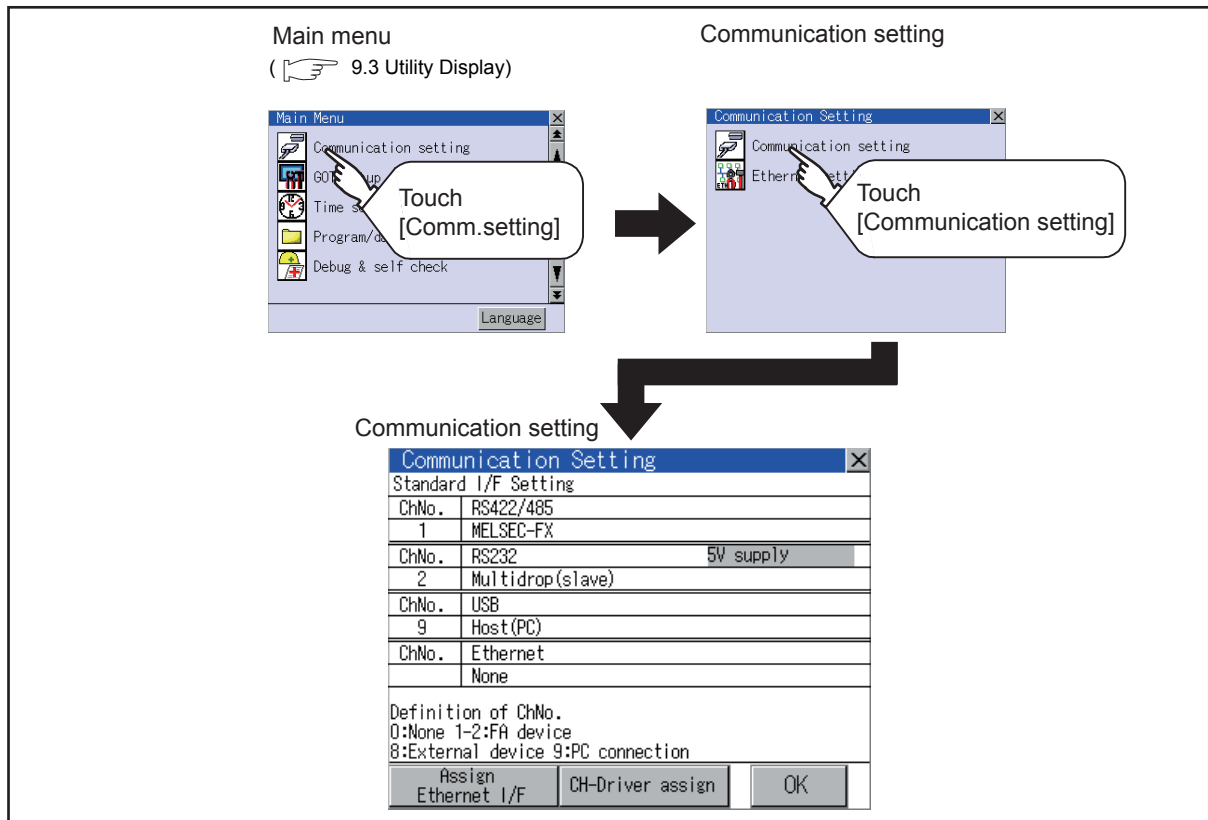

10.1.3 Communication setting contents

This section describes setting items and display contents for Communication Setting.

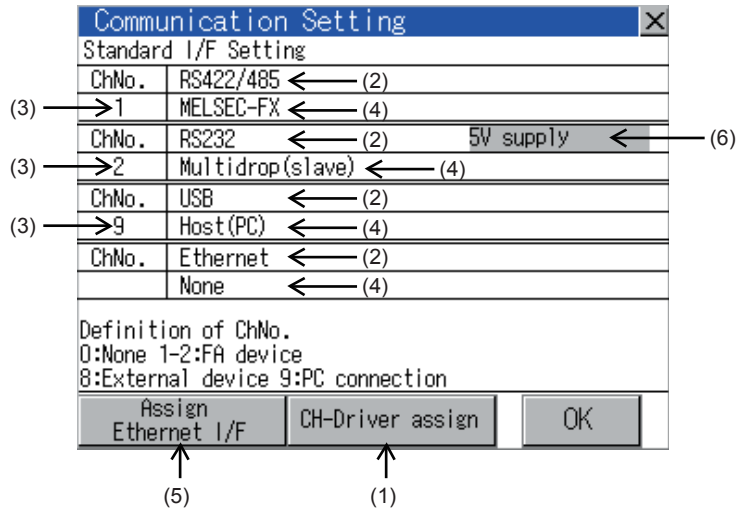

(1) Channel-Driver assign

Channel No. can be assigned to the communication driver installed in the GOT.

(a) Not writing [Communication Setting] in drawing software

Without writing [Communication Setting] in drawing software, communication with a controller is available after assigning the channel No. with this function.

👉 10.1.4 ■ Channel-Driver assign operation

(b) When changing the assignment of the communication driver to the channel in the Utility

Without using drawing software, the assignment of communication drivers to channels can be changed.

(When changing a communication driver, the alternative communication driver has to be installed in GOT in advance.)

(2) Standard interface display BOX

Display the communication interface included as standard in GT14. There are the following 4 types.

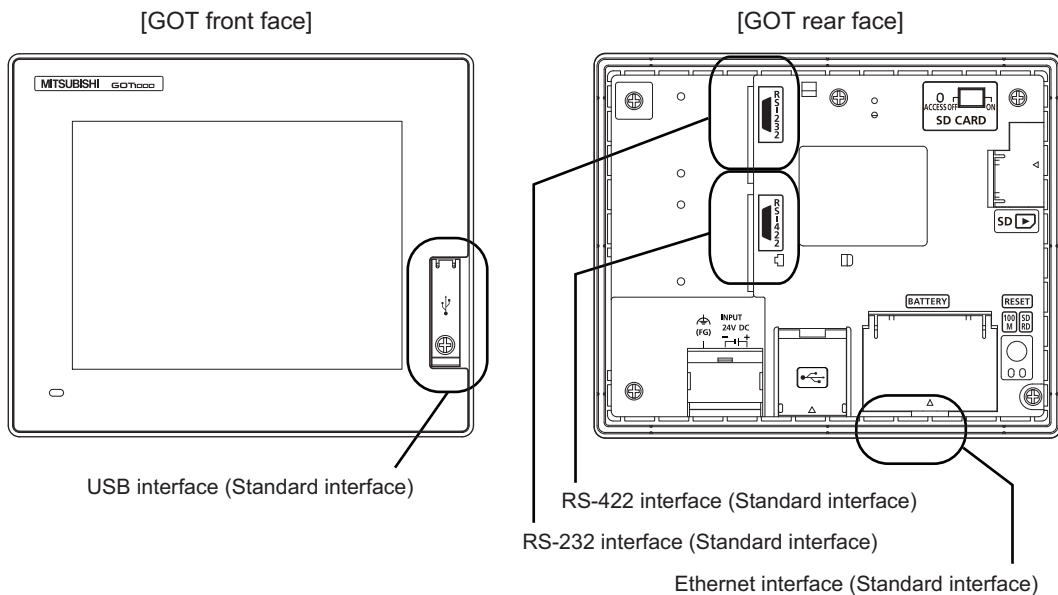

- RS-232..... For communicating with PC (drawing software), bar code reader, RFID, controller or controller
- RS-422/485..... For communicating with controller
- USB..... For communicating with PC (drawing software)
- Ethernet..... For communicating with PC (drawing software) or controller

(3) Channel number specification menu BOX

Set channel No. to use with standard interface.

Refer to this section (4) for driver that can be assigned to each channel.

- 0: Set when the communication interface is not used.
- 1, 2: Set when connecting to a controller.
- 8: Set when connecting with a bar code reader or RFID.
- 9*1: Set when connecting with PC (drawing software).
- *: Set when using the function that uses the gateway function (when connection types except the Ethernet connection is used for connecting to controllers), Ethernet download function.

- Fixed to 9 for the USB interface.

*1 Cannot be assigned with Ethernet I/F Assignment.

(4) Driver display BOX

The name of communication driver assigned to the channels or the driver set with the Communication Setting of drawing software is displayed.

For details of drivers to be displayed, refer to the following manual.

➔ GT Designer3 Version1 Screen Design Manual (Fundamentals)

Displays [None] in the driver display BOX in case of the following.

- The communication driver is not installed. (➔ 13.2.1 OS information)
- In channel number specification menu BOX, [0] is set.

When the channel number is set to [9] to RS-232 interface, the communication driver [Host (PC)] or [Host (model)] can be selected.

When the channel number is set to [9] to USB interface, the communication driver [Host (PC)] is automatically assigned.

(5) Assign Ethernet I/F

The communication settings for the Ethernet connection can be made.

Only Ethernet interface built-in model can display this button.

Ethernet I/F Assignment can assign up to two channels per interface.

➔ 10.1.4 ■ Assign Ethernet I/F operation

(6) 5V power supply

Set the 5V power supply when using the RS-232/485 signal conversion adaptor.

➔ 10.1.4 ■ 5V power supply operation

POINT

Precautions for communications between GOT and controller

(1) Installing communication driver and downloading Communication Setting

The following below is required for the communication interface to communicate with the controller.

- 1) Installing communication drivers (Up to 4 communication drivers)
- 2) Assigning the channel number and communication driver for the communication interface
- 3) Downloading the contents (project data) assigned in 2).

Perform1), 2), 3) by drawing software.

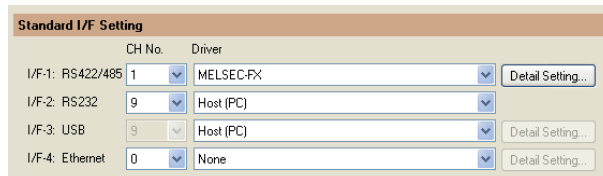

For details, refer to the following.

➔ GT Designer3 Version1 Screen Design Manual (Fundamentals)

(2) When Communication Setting has not been downloaded.

When [Communication Setting] has not been downloaded using drawing software, make the communication settings in the drawing software or on the utility screen of the GOT.

10.1.4 Communication setting operation

■ Channel-Driver assign operation

The following describes how to operate the Channel-Driver assign.

The example of changing to the direct CPU connection (Communication driver: [A/QnA/L/QCPU, LJ71C24, QJ71C24]) for the GOT of the computer link connection (Communication driver: [AJ71QC24, MELDAS C6*]) is used.

POINT

Before starting operation

After Communication Setting is executed, the GOT automatically restarts.

If the project data is downloaded, GOT starts monitoring the communication device after restarting.

Execute this setting after carefully confirming the safety.

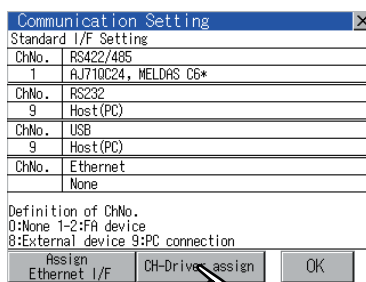

1. Install communication driver [A/QnA/L/QCPU, L/QJ71C24] to GOT.
(Download of [Communication Setting] from drawing software is not required.)
After installing communication driver, touch the [Channel Driver assign] button in [Communication Setting].

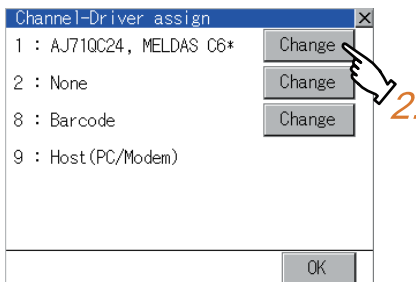

2. Touch the [Change assignment] button on the displayed screen as shown left.

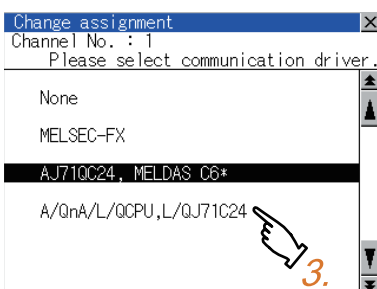

3. As the communication driver ([A/QnA/L/QCPU, L/QJ71C24]) installed in the GOT is displayed, touch it.



(Continued to next page)

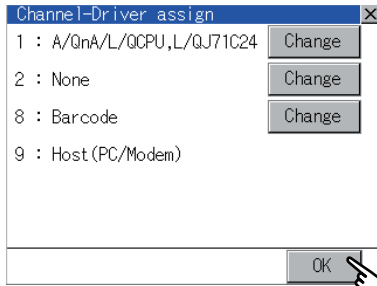

4.

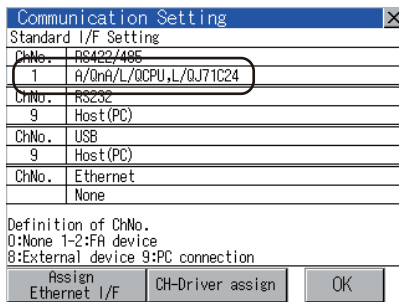

4. The screen returns to the [Channel-Driver assign] screen and touch the [OK] button.
5. Touch [×] button to return to the [Communication Setting] screen.

6. Confirm that the selected communication driver ([A/QnA/L/QCPU, L/QJ71C24]) is assigned.
7. After confirming, touch the [OK] button.
8. Touching the [×] button restarts the GOT and the GOT operates with the changed settings.

■ Channel number setting operation

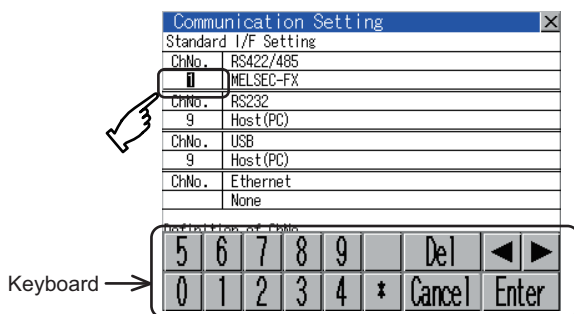

1. Touch channel number specification menu BOX to be set.
2. The cursor for the channel number specification menu BOX is displayed. Simultaneously the keyboard for a numerical input is displayed.

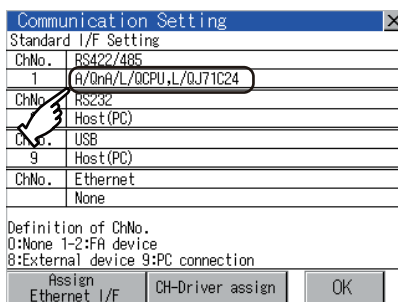

3. Input the channel number from the keyboard and touch [Enter] key, and the value is defined. Simultaneously, the name of the communication driver corresponding to the channel number assigned by drawing software is displayed in the driver display BOX.

■ Communication detail setting switching operation

If the driver display BOX is touched on the communication setting screen or Ethernet I/F assign screen, the screen switches to the detailed setting screen of the related controller device.

(10.2 Communication Detail Setting)

■ Assign Ethernet I/F operation

The following describes how to operate the Ethernet I/F assign.

The setting operation is same as that of the communication setting screen.

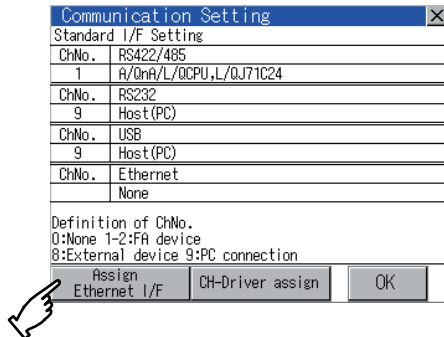

1. Touch the [Assign Ethernet I/F] button in [Communication Setting].

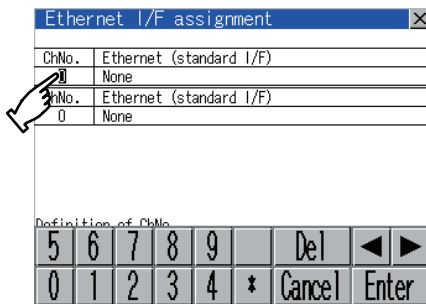

2. After the screen shown left is displayed, touch the channel number specification menu BOX when changing the channel number.
 (☞ 10.1.4 ■ Channel number setting operation)

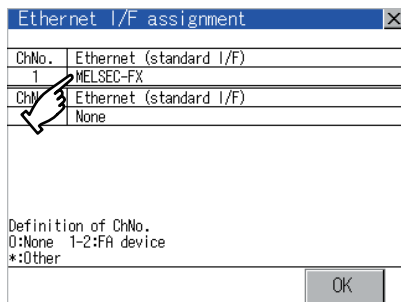

3. For changing the parameter settings, touch the driver display BOX.
 (☞ 10.2Communication Detail Setting)
4. Touching the [OK] button reflects the changed settings. Touching [x] button returns the screen to the [Communication Setting] screen.

5. Touch the [OK] button in the [Communication Setting] screen.

6. Touching the [x] button restarts the GOT and the GOT operates with the changed settings.

■ 5V power supply operation

The following describes how to operate the 5V power supply.

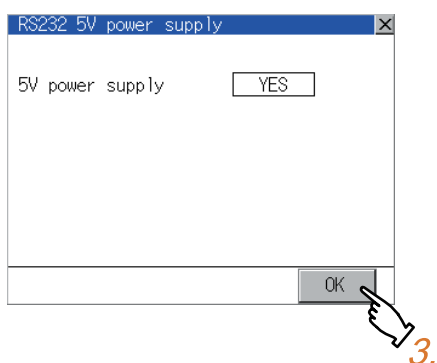
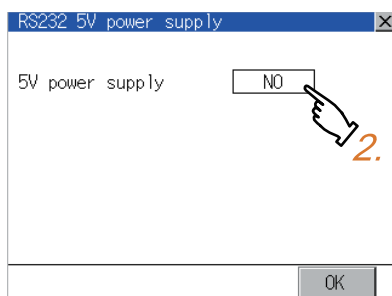
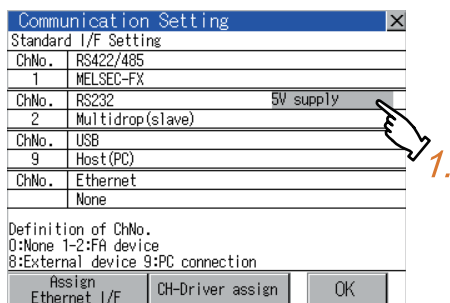

1. Touch the [5V power supply] button in [Communication Setting].

2. Touch the setting item of [5V power supply] when using the RS-232/485 conversion adaptor. The setting content is changed by touching. (YES ↔ NO)

3. Select [Yes] to change the setting of the 5V power supply. Touching the [OK] button reflects the changed settings. Touching [×] button returns the screen to the [Communication Setting] screen.

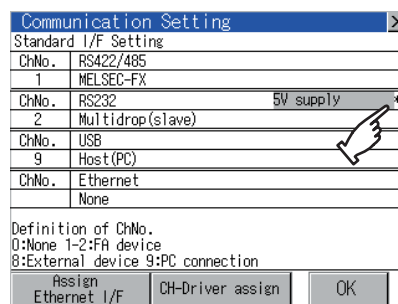

"*" indicating the setting to supply the 5V power supply is displayed.

4. Touch the [OK] button in the [Communication Setting] screen.
5. Touching the [×] button restarts the GOT and the GOT operates with the changed settings.

10.2 Communication Detail Setting

10.2.1 Communication detail setting functions

Function	Description
Communication parameters setting	Set various communication parameters of communication devices. The settable parameters differ according to the communication device.
Keyword Register	For the FX series PLCs, key word for protecting program in the PLC can be set.
Keyword Delete	For the FX series PLCs, key word for protecting program in the PLC can be deleted.
Keyword Clear	For the FX series PLCs, the program protection status in the PLC can be cancelled.
Keyword Protect	For the FX series PLCs with the 2nd keyword in use, the cancelled program protection in the PLC can be reactivated.

10.2.2 Display operation of Communication Detail setting

■ Communication settings

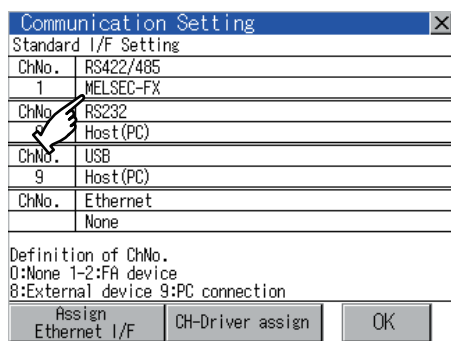

1. Touch the driver display BOX of the communication parameter to be set in the [Communication setting] screen.

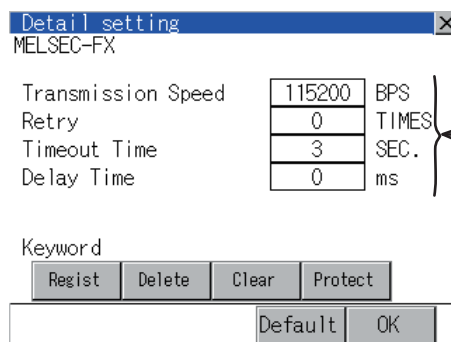

2. The screen switches to the [Communication Detail setting] screen. Set communication parameters from this screen. For the setting change operation, refer to the following.

9.3.3 Basic operation of settings change

POINT

Communication parameter setting by drawing software

Select [Common Settings] → [Communication Settings] from GT Designer3 to enter the communication parameters for each communication driver.

When changing the communication parameters after downloading project data, change the setting at communication detail setting of GOT.

GT Designer3 Version1 Screen Design Manual (Fundamentals)

Assign Ethernet I/F

Several drivers are assigned to the same Ethernet interface. However, only one GOT IP address is assigned per interface.

By changing the settings of one interface, the GOT IP address, GOT port No. download, default gateway and subnet mask settings of other drivers, which are assigned to the same interface, are also changed.

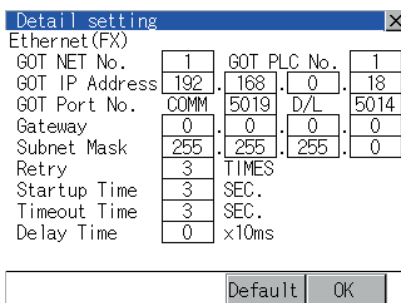
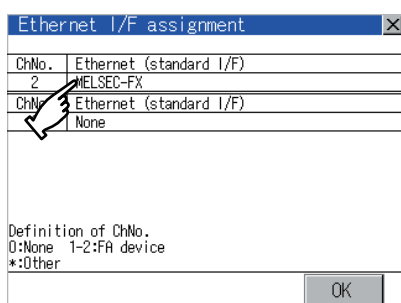
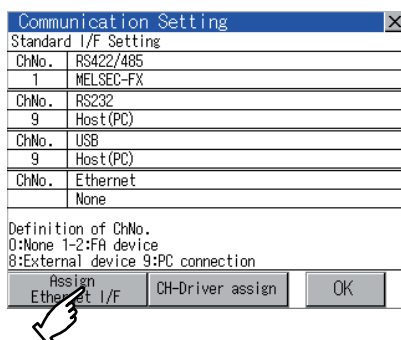

1. Touch the [Assign Ethernet I/F] button in Communication Setting.

2. Touch the driver display BOX of the communication parameter to be set in Ethernet I/F assignment.

3. The screen switches to the [Communication Detail setting] screen. Set communication parameters from this screen. For the setting change operation, refer to the following.

 9.3.3 Basic operation of settings change

POINT

Communication parameter setting by drawing software

Select [Common Settings] → [Communication Settings] from GT Designer3 to enter the communication parameters for each communication driver.

When changing the communication parameters after downloading project data, change the setting at communication detail setting of GOT.

 GT Designer3 Version1 Screen Design Manual (Fundamentals)

10.2.3 Display contents of Communication Detail setting

The contents of communication detail setting varies according to driver type.

This section explains setting items different from the communication detail setting of the drawing software. For setting items other than described in this section, refer to the following manual.

 GT Designer3 Version1 Screen Design Manual (Fundamentals)

■ Communication detail setting of host (modem)

On the communication detail setting screen of host (modem), the communication setting between the GOT and the modem and the modem operation can be executed.

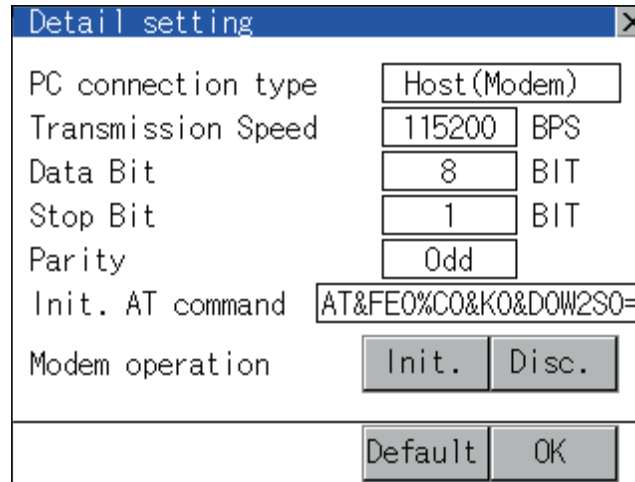

Item	Setting
PC connection type	Host (Modem)
Transmission Speed	115200 BPS
Data Bit	8 BIT
Stop Bit	1 BIT
Parity	Odd
Init. AT command	AT&FE0%CO&K0&D0W2S0=
Modem operation	Init. Disc.
	Default OK

Item	Description	Setting range
PC connection type	Select the connection method to the PC.	Host (PC) / Host (Modem) <Default: Host (PC)>
Transmission Speed	Set the transmission speed when communicating.	9600/19200/38400/57600/115200 <Default: 115200>
Data Bit	Set the data bit when communicating.	7bit/8bit <Default: 8bit>
Stop Bit	Set the stop bit length when communicating.	1bit/2bit <Default: 1bit>
Parity	Set whether to execute or not the parity check during communication. When executing, set the type of the parity check.	Odd/Even/None <Default: Odd>
Init. AT command	Set the AT command for initialize the modem.	<Default: AT & FE0%CO & K0 & D0W2S0=1>
Modem operation	Touch the [Init.] button to initialize the modem. Touch the [Cut] button to disconnect the line.	-

■ Keyword settings of MELSEC-FX

On the communication detail setting screen of MELSEC-FX, registration, deletion, cancellation, or protection of the keyword for FX series PLC can be executed.

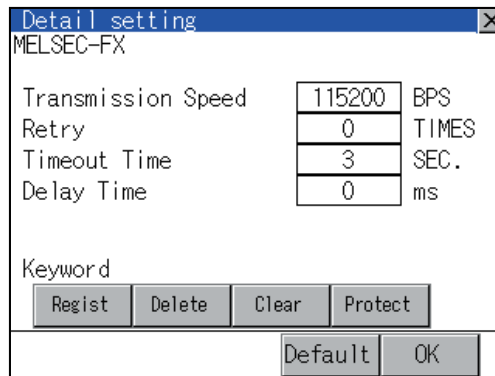

- (1) Regist
Keyword is registered.

1. Touching the [Regist] key displays the Registration Selection screen.
For a FX PLC*1 that is not compatible with the customer keyword, the keyboard for the keyword input of 2. is displayed.
Select [Keyword] or [Keyword and Customer keyword].
When the [Enter] key is touched, the selection is completed and the keyboard for the keyword input is displayed.

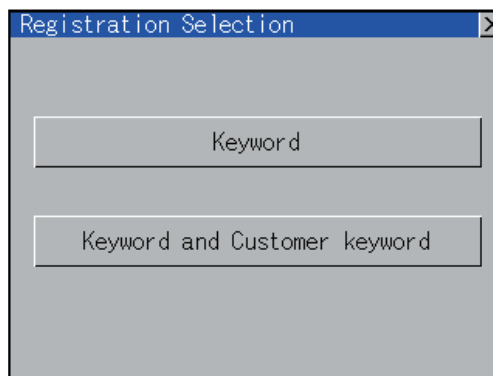

Selection	Description
When [Keyword] is selected	Only keyword can be registered.
When [Keyword and Customer keyword] is selected	The Customer Keyword can be registered after registration of the keyword.

*1: For details on FX PLC compatible with customer keyword, refer to the manual of the PLC used.

POINT

The customer keyword allows the user to clear the protection set by a keyword. However, the protection cannot be deleted.

- When the registration is selected or the Register key is touched on a PLC not compatible with the customer keyword, the keyboard for the keyword input is displayed in a pop-up window.
When the keyword is input and the [Enter] key is touched, registration is completed.
When [Keyword and Customer Keyword] is selected on the selection screen for the registration, the Customer Keyword entry screen of 3. is displayed.
For the keyword, 8 digits from 0 to 9 or A to F must be set.



Target PLC	Setting	
	When keyword and 2nd keyword are registered	When only keyword is registered
FX PLC compatible with 2nd keyword ^{*1}	[Registration condition] ^{*2} can be selected.	[Registration condition] ^{*2} cannot be selected.
FX PLC not compatible with 2nd keyword ^{*1}	-	

*1 For details on FX PLC compatible with 2nd keyword, refer to the manual of the PLC used.

*2 [Registration condition]
Options can be selected among [Read/Write Protect], [Write Protect], or [All Protect].
For access restrictions of each setting, refer to the manual of the PLC used.

- When [Keyword and Customer Keyword] is selected on the selection screen for registration and the keyword input is completed, the Customer Keyword registration screen is displayed.
When the customer keyword is input and the [Enter] key is touched, registration is completed.
To set the customer keyword, 8 digits from 0 to 9 or A to F must be used.

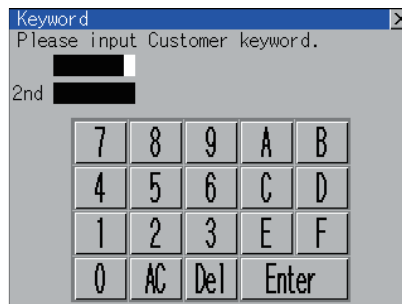

POINT

(1) Selection of keyword protection level

For the devices which can perform the online operation of FX PLC, 3 levels of protection can be set. When the monitoring or setting change by online devices is needed, set the keyword taking the following into consideration.

(a) When only keyword is registered

Protection level is selected by the head character of keyword.

All operation prohibition: Set the keyword starting with one of A, D to F, or 0 to 9.

Read/incorrect write protection: Set the keyword starting with B.

Erroneous write prohibition: Set the keyword starting with C.

(b) When keyword and 2nd keyword are registered

Protection level is selected by [Registration condition].

(2) Applicability of monitoring for each keyword protection level

The applicability of monitoring for each protection level is as follows.

Item	When only keyword is registered			When keyword and 2nd keyword are registered			Keyword unregistered/ protection cancelled
	All operation prohibition	Read/Incorrect write protection	Erroneous write prohibition	All Protect	Read/Write prohibition	Write Protect	
Device monitoring	○	○	○	×	○	○	○
Device change	T, C setting values and file register (from D1000)	× ^{*1}	× ^{*1}	× ^{*1}	×	○	○
	Other than the above	○	○	○	×	○	○

*1 When the T, C setting values are specified indirectly, changing devices is available.

(3) Difference between [All Protect] and [All operation prohibition]

When [All Protect] is selected, both device display and input by the programming tool or GOT are prohibited. When [All operation prohibition] is selected, device display and input are possible although operations by the programming tool are all prohibited.

- (2) Delete
Registered keyword is deleted.

1. Touching the [Delete] key pops up a keyboard for keyword input.
2. When the correct keyword is input and the [Enter] key is touched, the keyword is deleted.

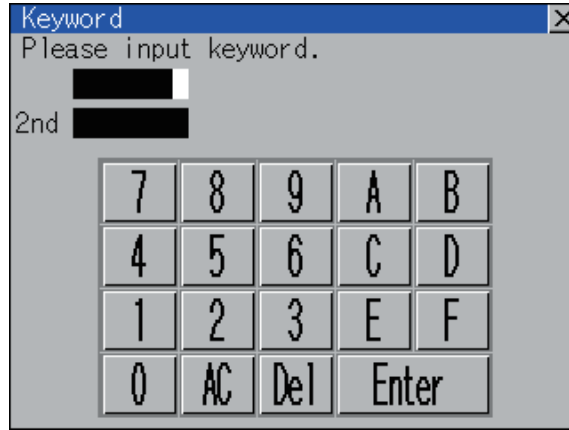

Target PLC	Setting
FX PLC compatible with 2nd keyword	Input a keyword to be deleted.
FX PLC not compatible with 2nd keyword	Input a keyword to be deleted only into "keyword". "2nd keyword" is ignored.

- (3) Clear
To access an FX PLC where a keyword has been registered, keyword protection is cancelled.

1. Touching the [Clear] key pops up a keyboard for keyword input.
2. When the correct keyword is input and the [Enter] key is touched, the protection is cancelled.



Target PLC	Setting
FX PLC compatible with 2nd keyword	Input a keyword or Customer Keyword to cancel the protection.
FX PLC not compatible with 2nd keyword	Input a keyword only into "keyword" to cancel the protection. "2nd keyword" is ignored.

- (4) Protect
A keyword with cancelled protection is reactivated for protection.

1. Touching the [Protect] key activates keyword protection.

10.3 Ethernet Setting

10.3.1 Ethernet setting functions

The contents of the Ethernet setting in drawing software can be checked.
The setting of the host station can be changed.
For Ethernet setting, refer to the following.

 GOT1000 Series Connection Manual for GT Works3

10.3.2 Display operation of Ethernet setting

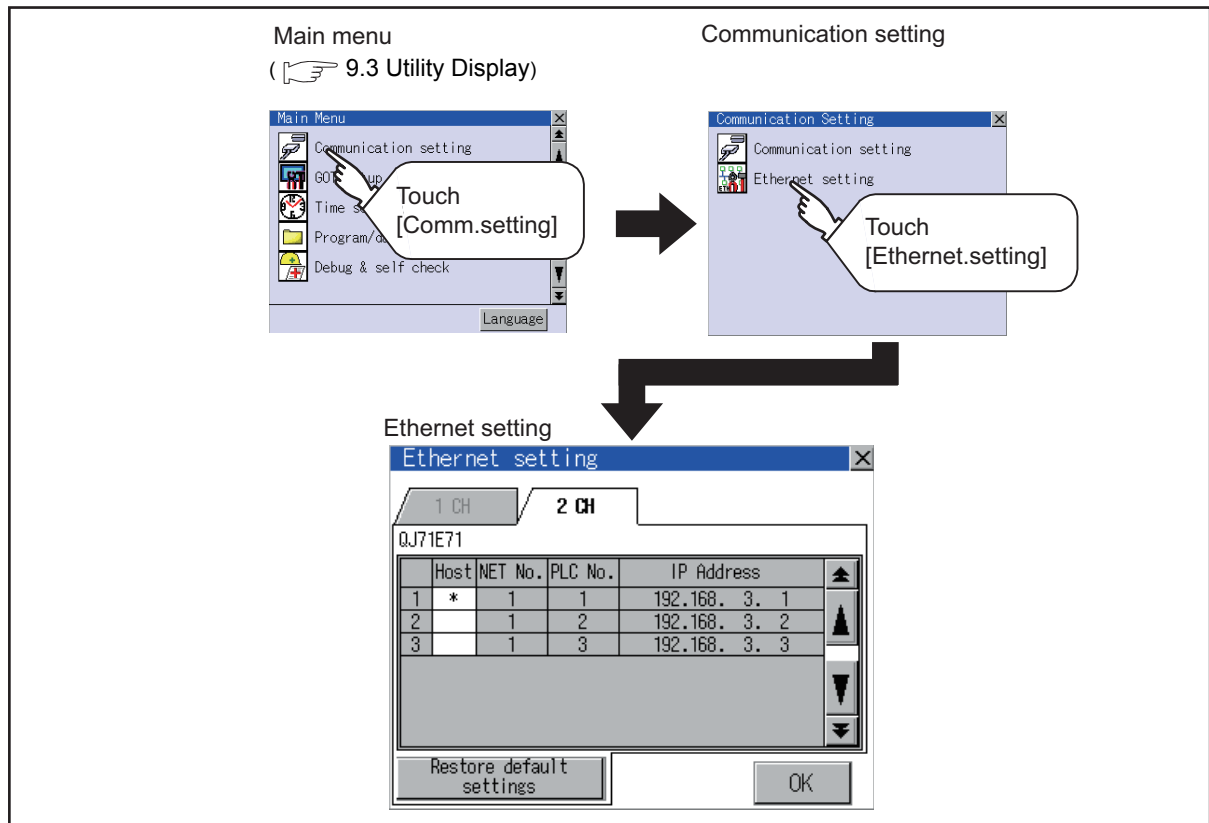

10.3.3 Display contents of Ethernet setting

The following describes the setting items and the display contents of the Ethernet setting.

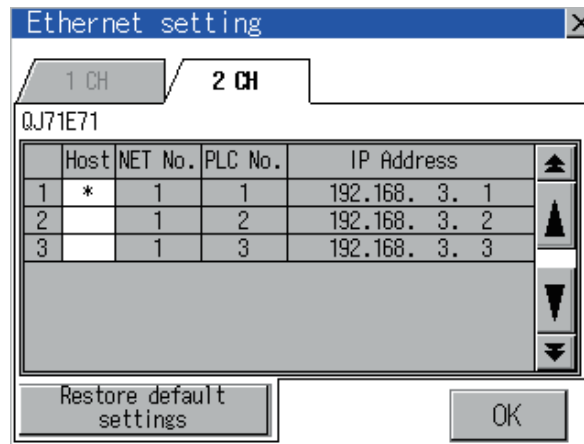

- (1) Channel selection tab
Channels can be switched.
Switching to the channel which does not have the Ethernet setting is not available.
[*] is displayed on the tab of the channel whose setting is changed.
- (2) Ethernet setting item
The contents of the Ethernet setting configured in drawing software are displayed.
The setting of the host station can be changed.
 ■ Change of host
- (3) Restore default settings
Touching this button cancels the change of the setting and returns the setting to the status when the project data was written.

POINT

- (1) How to cancel the change of the setting in the [Ethernet setting] screen
Cancel the settings changed in the [Ethernet setting] screen with the [Restore default settings] button.
The changed settings remain until they are canceled with the [Restore default settings] button.
The changed settings are not canceled even if writing the project data or OS to the GOT.
When the project data is written to the GOT without canceling the changed settings, those changed settings are reflected to the Ethernet setting of the written project data.
(If the written project data does not have a channel with same Ethernet settings as that of the channel changed in [Ethernet setting] screen, the changed settings are not reflected.)
- (2) Range where the settings changed in the [Ethernet setting] screen are reflected
The settings changed in the [Ethernet setting] screen are valid in the GOT. On the other hand, they are not overwritten to the project data written to the GOT.
The changed settings are not reflected to the project data which is read from the GOT after changing the settings.
If the GOT data is copied with the GOT data package acquisition, the change in the [Ethernet setting] screen is reflected to the copied data.

Change of host

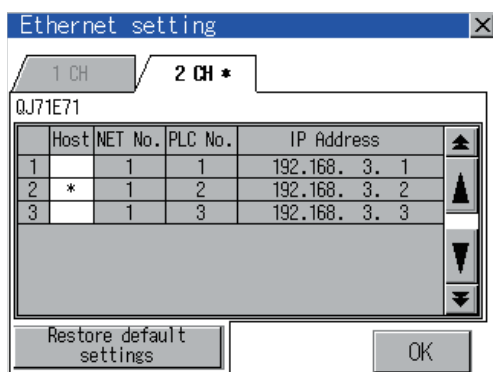
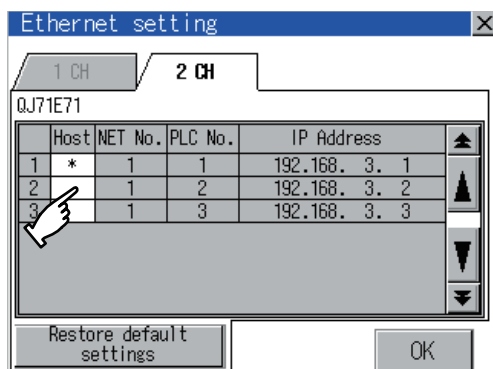

1. Touch the device to be set as the host.

2. Touch the [OK] button.

3. Touching the [x] button restarts the GOT and the GOT operates with the changed settings.

11. DISPLAY AND OPERATION SETTINGS (GOT SET UP)

Setting screen for display and setting screen for operation can be displayed from the utility screen. In the setting screen for display and the setting screen for operation, the following settings can be set.

Item	Description	Reference
Display	Language, opening screen time, screen save time, screen save backlight, battery alarm display and invert colors	11-1
	Adjusting brightness and contrast	11-5
Operation	Buzzer volume, window move buzzer volume, key sensitivity, key reaction speed, touch detection mode	11-6
	Security setting	11-9
	Utility call key	11-11
	Touch panel calibration	11-13
	USB mouse/keyboard setting	11-15
Transparent mode	Ch No.	11-17
Backup/restoration	Setting the storage locations for backup data and backup settings, and setting the maximum number of backup data	11-18
	Setting the CPU No. setting at backup to "YES" or "NO"	11-19
	Trigger backup settings	11-20
Behavior of duplicate IPs	Setting the GOT operation when a device with the same IP address as that of the GOT is added to the network afterwards.	11-21

11.1 Display Setting

11.1.1 Function of Display

Setting regarding display is possible. The items which can be set are shown below. When each item part is touched, the respective setting becomes possible.

Item	Description	Setting range
Language*1	Confirmation of the current language and switching language can be performed regarding with the language displayed by utility and dialog box.	<input type="button" value="日本語"/> (Japanese) <input type="button" value="English"/> (English) <input type="button" value="中文(简体)"/> (Chinese (Simplified)) <input type="button" value="中文(繁體)"/> (Chinese (Traditional)) <input type="button" value="한국어"/> (Korean) <input type="button" value="Deutsch"/> (German) (At factory shipment: User's selection)
Opening screen time	The title display period at the main unit boot can be set.	0 to 60 seconds*2 (At factory shipment: 5 seconds)
Screen save time	The period from the user stops the touch panel operation till the screen save function starts can be set.	0 to 60 minutes (At factory shipment: 5 seconds)
Screen save backlight	Whether turning ON or OFF the backlight simultaneously at the start of the screen save function can be specified.	ON/OFF (At factory shipment: OFF)
Battery alarm display	Whether to display system alarm when the voltage of the GOT internal battery has dropped can be specified.	ON/OFF (At factory shipment: OFF)
Brightness, contrast	The brightness can be adjusted.  ■ Brightness, contrast	-
Invert colors (only GT1450-Q)	For the user-created screen and the utility screen, whether to invert the displayed colors can be specified.	ON/OFF (At factory shipment: OFF)

*1 Only selectable languages are displayed. The selectable languages differ depending on the fonts installed in the GOT. For details of the fonts, refer to the following manual.

 GT Designer3 Version1 Screen Design Manual (Fundamentals)

*2 Setting 0 does not hide the title screen. The title screen is always displayed for 4 seconds or longer (which changes depending on the project data contents).

POINT

- (1) Display setting by GT Designer3
Select [Common Settings] → [GOT Environment Settings] → [GOT Setup] from GT Designer3 to make the settings of opening screen time, screen save time and screen save backlight.
To change a part of the setting after downloading the project data, change the setting at the display setting of GOT.

☞ GT Designer3 Version1 Screen Design Manual (Fundamentals)

- (2) Screen save time
Using the system information function can compulsorily switch the controller to the screen saving status (Forced Screen Saver Disable Signal) or disable the screen save time (Automatic Screen Saver Disable Signal) set with Utility.

☞ GT Designer3 Version1 Screen Design Manual (Fundamentals)

- (3) Screen save backlight
When [Screen save backlight] is set to [ON], using the system information function (Backlight OFF output signal) can switch the backlight OFF from the controller.
When [Screen save backlight] is set to [OFF], the above signal has no effect on the screen save backlight.

☞ GT Designer3 Version1 Screen Design Manual (Fundamentals)

11.1.2 Display operation of Display

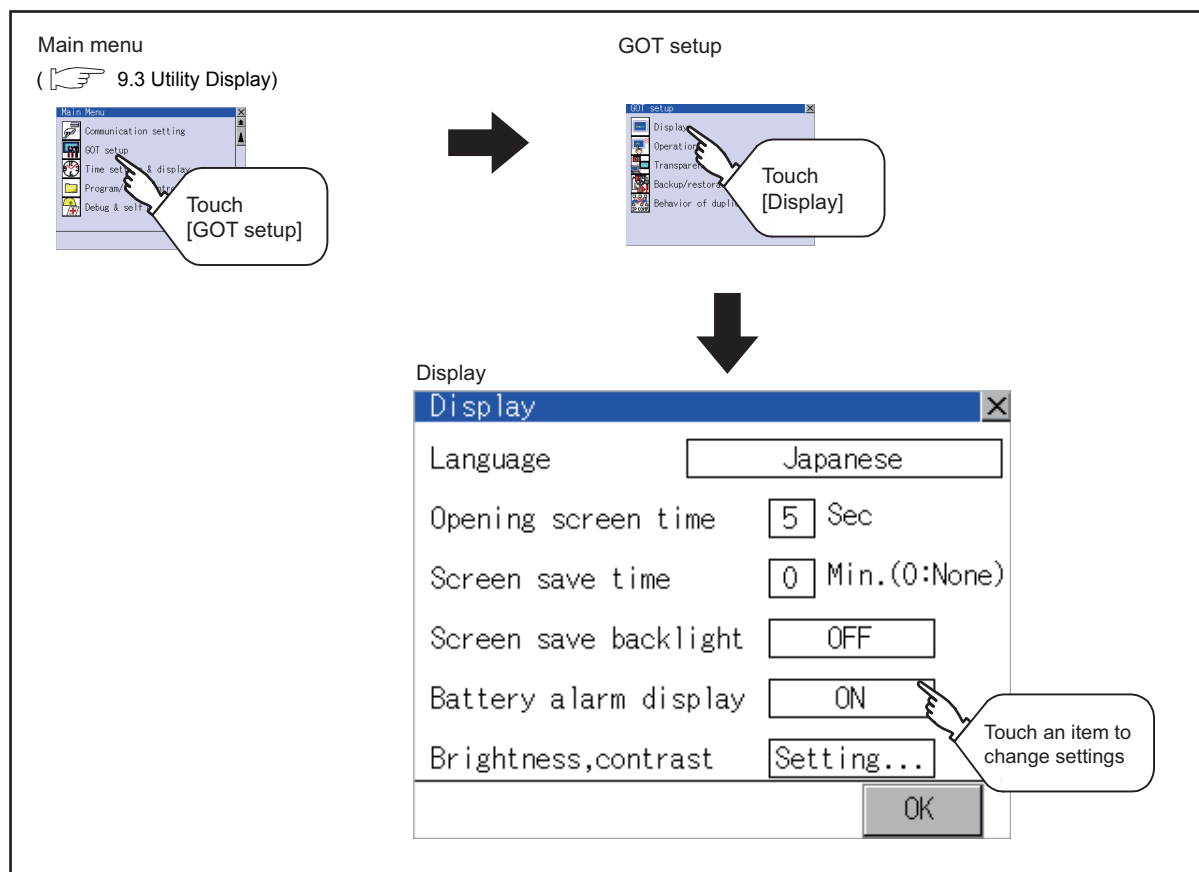

11.1.3 Display operations

Language

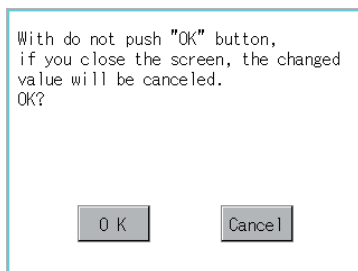
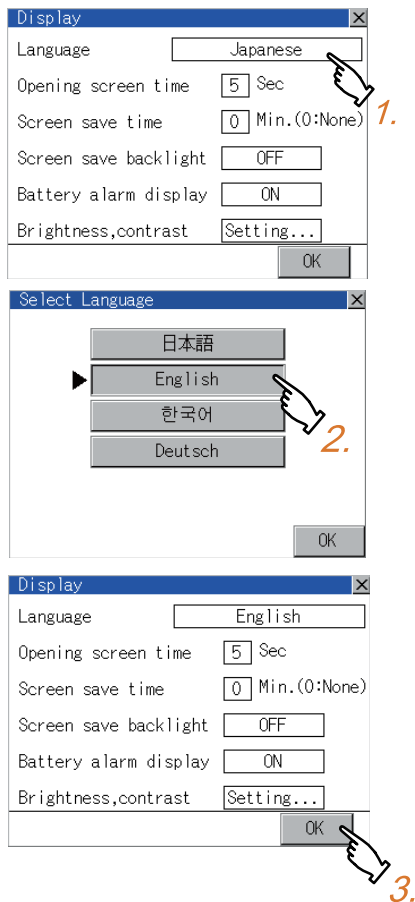

1. Touching the setting items displays the Select Language screen.
2. Touching the button of a desired language selects the language and returns the screen to the Display screen.
3. Touching [OK] button defines the setting contents.

Touching [×] button without touching [OK] button displays the dialogue box shown on the left.
 [OK] button: The changed value is canceled, and the screen is closed.
 [Cancel] button: The display setting screen is displayed.

4. Closing the display setting and GOT setup screens after completing the setting of all items to change with [×] button restarts the GOT and reflects the setting contents.

HINT

(1) Selectable languages

The system message switch button is displayed only for the selectable languages. The selectable languages differ depending on the fonts installed in the GOT. For the relation between the selectable languages and the fonts, refer to the following.

☞ GT Designer3 Version1 Screen Design Manual (Fundamental) 2.5 Specifications of Applicable Characters

(2) System language switching using the device

The system language can be switched using the system language switching device set with GT Designer3. For the setting method of the system language switching device, refer to the following.

☞ GT Designer3 Version1 Screen Design Manual (Fundamentals)
 4.3 Language Switching Device Setting (GOT Environmental Setting: Language Switching)

■ Opening screen, screen save time

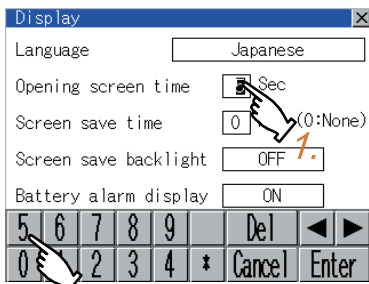

1. Touching the setting time (numerical) displays the keyboard.
Input numeric with the keyboard.

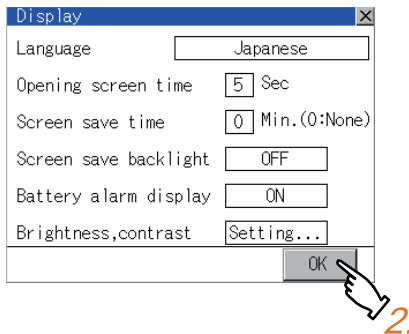

2. Touching [OK] button defines the setting contents.

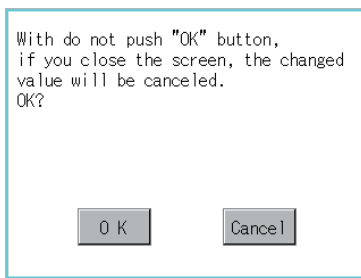

Touching [x] button without touching [OK] button displays the dialogue box shown on the left.
[OK] button: The changed value is canceled, and the screen is closed.

[Cancel] button: The display setting screen is displayed.

3. Closing the display setting and GOT setup screens after completing the setting of all items to change with [x] button restarts the GOT and reflects the setting contents.

■ Screen save backlight, battery alarm display, invert colors

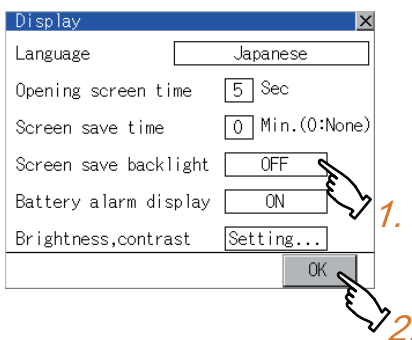

1. Touching the setting item changes the setting items.
(ON ↔ OFF)

2. Touching [OK] button defines the setting contents.

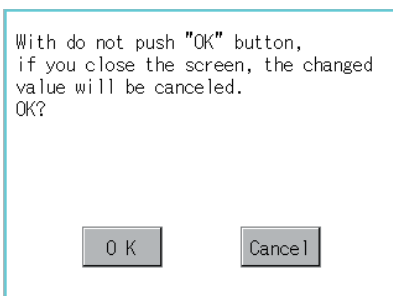

Touching [x] button without touching [OK] button displays the dialogue box shown on the left.
[OK] button: The changed value is canceled, and the screen is closed.

[Cancel] button: The display setting screen is displayed.

3. Closing the display setting and GOT setup screens after completing the setting of all items to change with [x] button restarts the GOT and reflects the setting contents.

■ Brightness, contrast

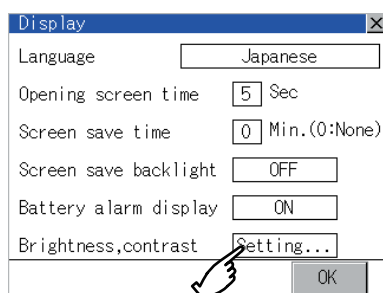

(For monochrome screen)

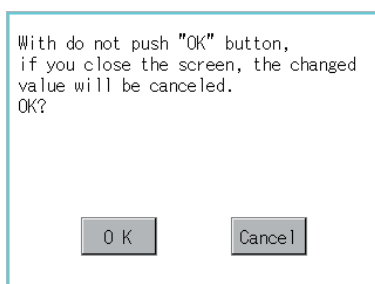
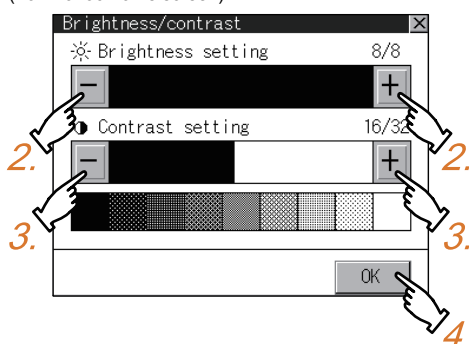

1. Touching the setting items displays the brightness contrast adjustment screen.

2. Brightness can be adjusted by touching [+], [-] key of brightness adjustment.

3. Contrast can be adjusted by touching [+], [-] key of contrast adjustment.

4. Touching [OK] button defines the setting contents.

Touching [x] button without touching [OK] button displays the dialogue box shown on the left.

[OK] button: The changed value is canceled, and the screen is closed.





[Cancel] button: The brightness/contrast adjustment screen is displayed.

11.2 Operation Setting (Settings Regarding Operation)

11.2.1 Operation setting functions

Setting regarding GOT operation can be set.

The items which can be set are described below. Touching the each item part makes the respective setting become possible.

Function	Description	Setting range
Buzzer volume setting	Buzzer volume setting can be changed.	OFF/SHORT/LONG (At factory shipment: SHORT)
Window move buzzer volume setting	Whether turn ON/OFF buzzer when move window can be selected.	ON/OFF (At factory shipment: ON)
Security setting screen change	Security level change screen can be displayed.  11.2.4 Security level change	-
Utility call key screen change	Utility call key setting screen can be displayed.  11.2.5 Utility Call Key Setting	-
Key sensitivity setting	The sensitivity of touch panel when GOT screen is touched can be set. E.g. a setting can be changed when double-touch is made when touching the GOT screen only once. (For preventing chattering)	1 to 8
Touch panel calibration	Touch panel reading error can be corrected.  11.2.6 Adjusting the touch panel position (Touch panel calibration)	-
USB mouse/keyboard setting	Set the setting items related with USB mouse/keyboard.  11.2.7 USB mouse/keyboard setting	-

POINT

Operation setting by GT Designer3

Select [Common Settings] → [GOT Environment Settings] → [GOT Setup] from GT Designer3 to make the settings of buzzer sound and buzzer sound at window move.

To change a part of the setting after downloading the project data, change the setting at the display setting of GOT.

 GT Designer3 Version1 Screen Design Manual (Fundamentals)

11.2.2 Display operation of Operation

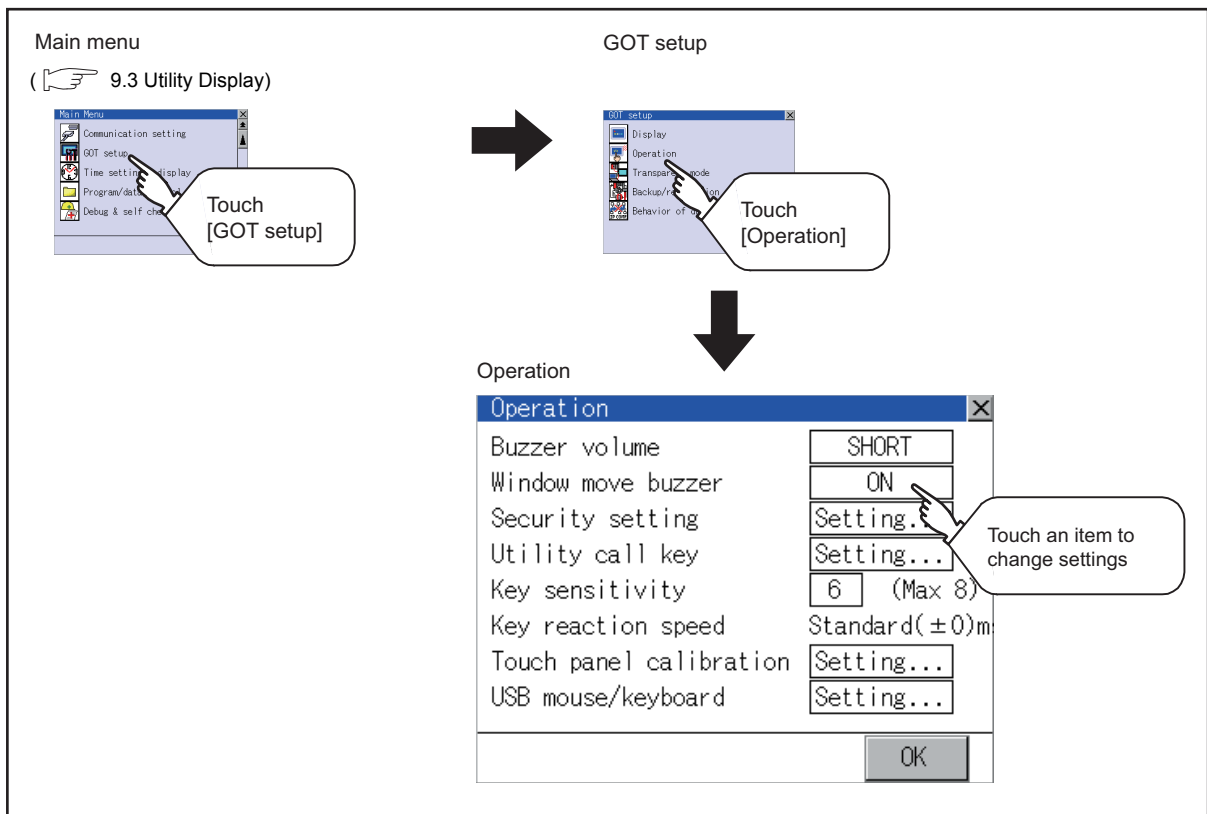

9	UTILITY FUNCTION
10	COMMUNICATION INTERFACE SETTING (COMMUNICATION SETTING)
11	DISPLAY AND OPERATION SETTINGS (GOT SET UP)
12	CLOCK SETTINGS AND BATTERY STATUS DISPLAY (TIME SETTING AND DISPLAY)
13	FILE DISPLAY AND COPY (PROGRAM/DATA CONTROL)
14	GOT SELF CHECK (DEBUG AND SELF CHECK)
15	CLEANING DISPLAY SECTION (CLEAN)
16	INSTALLATION OF COREOS, BOOTOS AND STANDARD

11.2.3 Setting operation of operation

■ Buzzer volume, window move buzzer volume

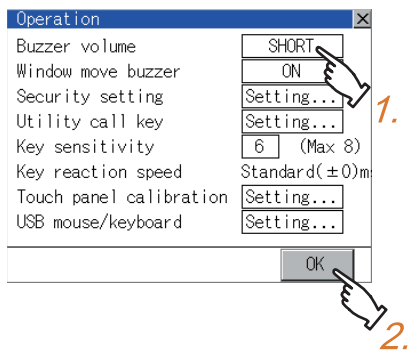

1. Touching the setting item changes the setting items.
2. Touching [OK] button defines the setting contents. Touching [×] button restarts the GOT and reflects the setting contents.

■ Security setting

For the security setting operation, refer to the following.

11.2.4 Security level change

■ Utility call key

For the utility call key operation, refer to the following.

11.2.5 Utility Call Key Setting

■ Key sensitivity setting

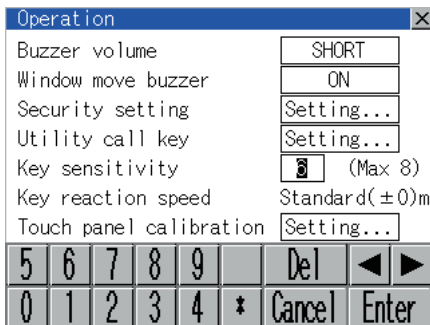

1. Touching the setting items displays the keyboard. Enter the numerical value from the keyboard.
2. The key response speed*¹ corresponding to the [Key sensitivity] setting is displayed.
3. Touching [OK] button defines the setting contents. Touching [×] button restarts the GOT and reflects the setting contents.

*1 Relation between the [Key sensitivity] setting and [Key reaction speed]

The larger the set value in [Key sensitivity] is, the shorter the time taken from touching the touch panel until the GOT responds becomes. E.g. decrease the value set for [Key sensitivity] when double-touch is made when touching the GOT screen only once. (Decrease the reaction speed.)

The relation between the [Key sensitivity] setting and [Key reaction speed] is as follows.

[Key sensitivity] setting	Quick response ← → Slow response							
	8	7	6	5	4	3	2	1
[Key reaction speed]	-20ms	-10ms	±0ms (Standard)	+10ms	+20ms	+40ms	+80ms	+120ms

■ Touch panel calibration

For touch panel calibration operation, refer to the following.

11.2.6 Adjusting the touch panel position (Touch panel calibration)

■ USB mouse/keyboard setting

For the USB mouse/keyboard setting, refer to the following.

11.2.7 USB mouse/keyboard setting

11.2.4 Security level change

■ Security level change functions

Changes the security level to the same security level set by each object or screen switch.

To change the security level, input the password of the security level which is set in GT Designer3.

Security level setting, Password setting.....  GT Designer3 Version1 Screen Design Manual (Fundamentals)

POINT

Restrictions on screen display

The security level change screen cannot be displayed when project data do not exist in GOT.

Change the security level after downloading the project data to GOT.

■ Display operation of Security level change

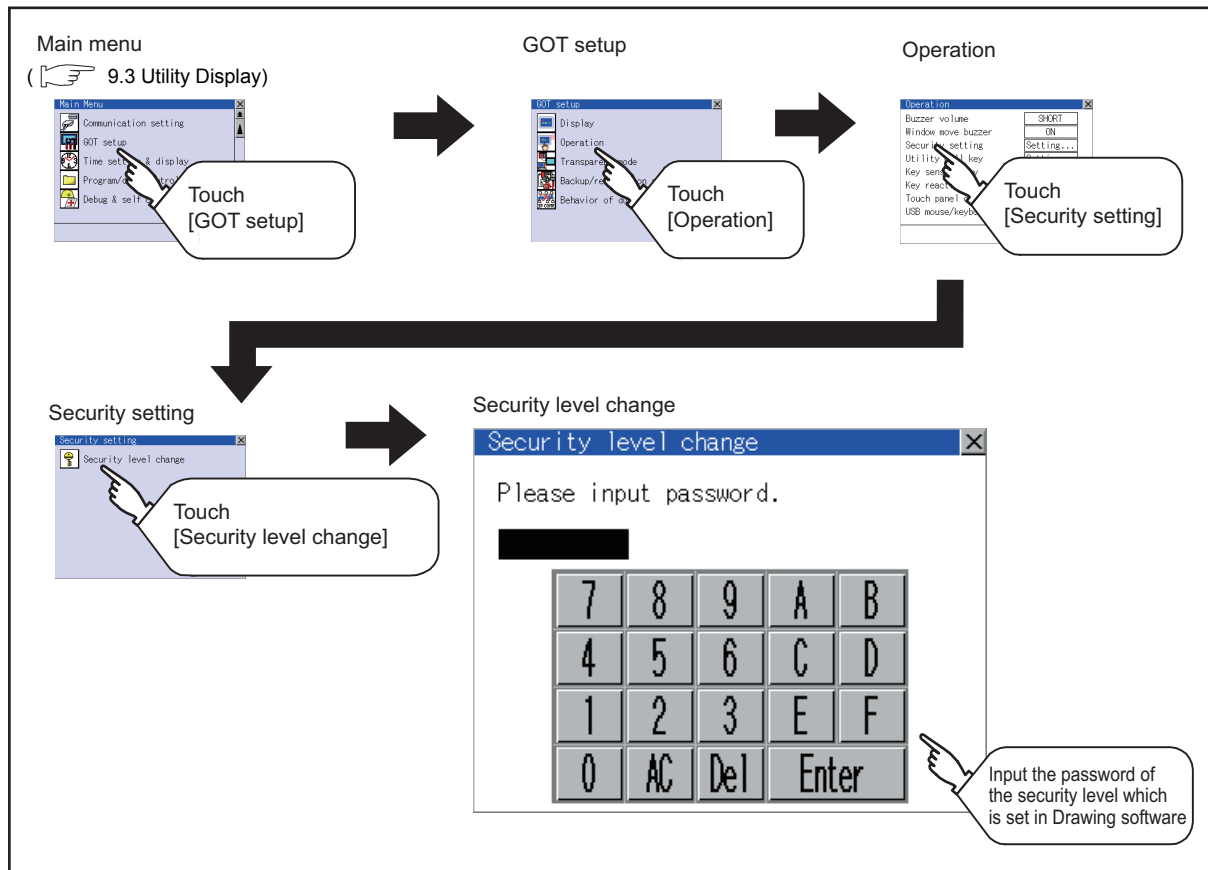

■ Security level change operation

(1) Password input operation

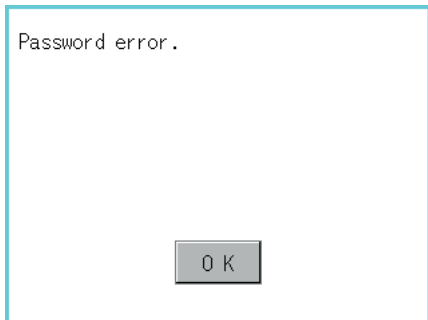
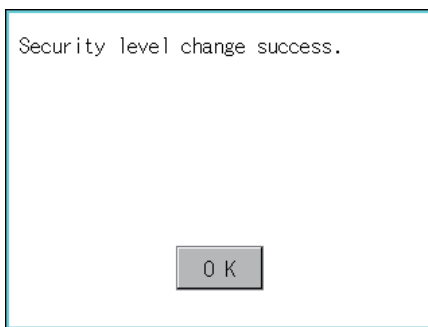
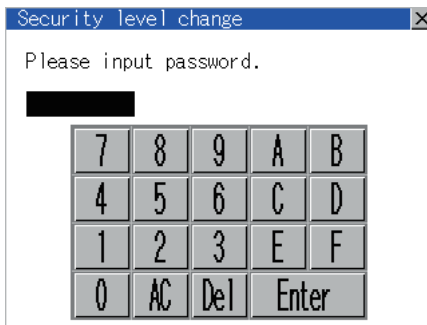

1. By touching [0] to [9] , [A] to [F] key, the password of the changed security level is input.
2. When correcting the input character, touch [Del] key to delete the correcting character and input the password again.
3. After inputting password, touch the [Enter] key. When the password matches, a message notifying successful change of the security level is displayed. When the password does not match, an error message is displayed.
4. Touching [OK] button returns the screen to the password input screen again.

5. Touching [×] button returns the screen to the security setting screen.

POINT

About forgetting to return to the original level after changing security level temporarily

When use GOT after temporarily changing the security level, do not forget to return the security level to the original level.

11.2.5 Utility Call Key Setting

Utility call key setting function

The key position for calling the main menu of the utility can be specified.

For the key position, 0 or 1 point can be specified from 4 corners on the screen.

By keeping pressing the screen, a setting to switch the screen to the utility is available.

This prevents a switching to the utility by an unintentional operation.

POINT

Operation setting by GT Designer3

Select [Common Settings] → [GOT Environment Settings] → [GOT Setup] from GT Designer3 to make the settings of the utility call key.

To change a part of the setting after downloading the project data, change the setting at the display setting of GOT.

 GT Designer3 Version1 Screen Design Manual (Fundamentals)

Display operation of Utility call key

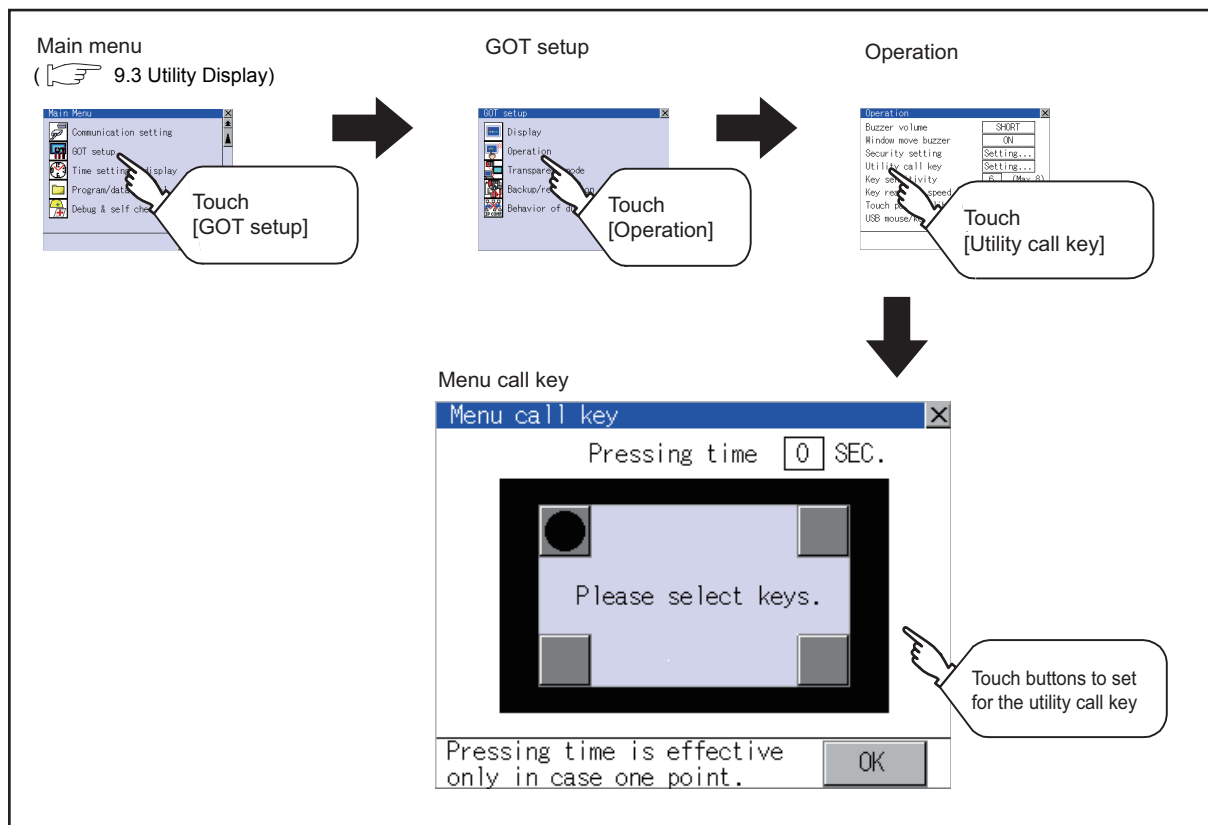

■ Setting operation of utility call key



1. Touch or displayed at the 4 corners of the setting screen. The button repeats with every touch. Set the corner to be set to a key position to .

For the key position, 0 or 1 point only can be set.

2. When setting 1 point, specify the time to switch to the utility in case of keeping pressing the key position. Touch the time input area.
3. Touching the input area displays a keyboard. Input numerical value from the keyboard.
4. Touching [OK] button defines the setting contents. Touching [x] button returns the screen to the [Operation] screen.

POINT

- (1) When the utility call key is set to the zero point

Even when the utility call key is set to the zero point, you can display the main menu using either of the following two operations:

- Pressing the special function switch set on the user-created screen
- Keeping pressing the upper left corner while the [Booting.] message is displayed after powering up.

☞ 9.3.1 Display operation of main menu

- (2) Precautions on using the advanced alarm popup display

When [Display Position Switching] is set to [Switch] in the advanced alarm popup display setting, set either of the following for the utility call key.

- Setting the position of the utility call key to the upper-right or lower-left corner
- Setting [Pressing Time] of the utility call key to 1 or more seconds

When [Pressing Time] is set to 0 and the key position is set to the lower-left corner, the operation is as described below. If the positions of the key and the advanced alarm popup display overlap, the utility screen appears by switching the display position of the advanced alarm popup display.

For the advanced alarm popup display, refer to the following.

☞ GT Designer3 Version1 Screen Design Manual (Functions)

- (3) When limiting the display and operation of the utility

When limiting the display and operating users, set a password to the GOT using the GT Designer3. If a user tries to display the main menu of the utility, the password input screen is displayed.

For details on setting passwords, refer to the following.

☞ GT Designer3 Version1 Screen Design Manual (Fundamentals)

11.2.6 Adjusting the touch panel position (Touch panel calibration)

■ Touch panel calibration setting function

Touch panel reading error can be corrected.

Normally the adjustment is not required, however, the difference between a touched position and the object position may occur as the period of use elapses.

When any difference between a touched position and the object position occurs, correct the position with this function.

Before adjustment

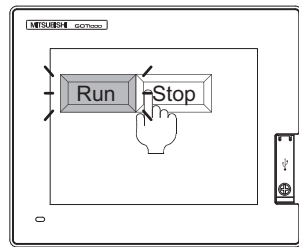

The [Run] will operate though you intended to touch the [Stop] button.

After adjustment

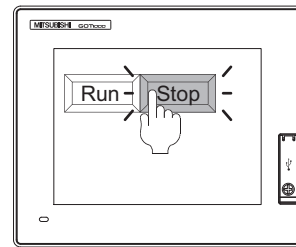

The [Stop] button can be touched without fail.

■ Display operation of Touch panel calibration

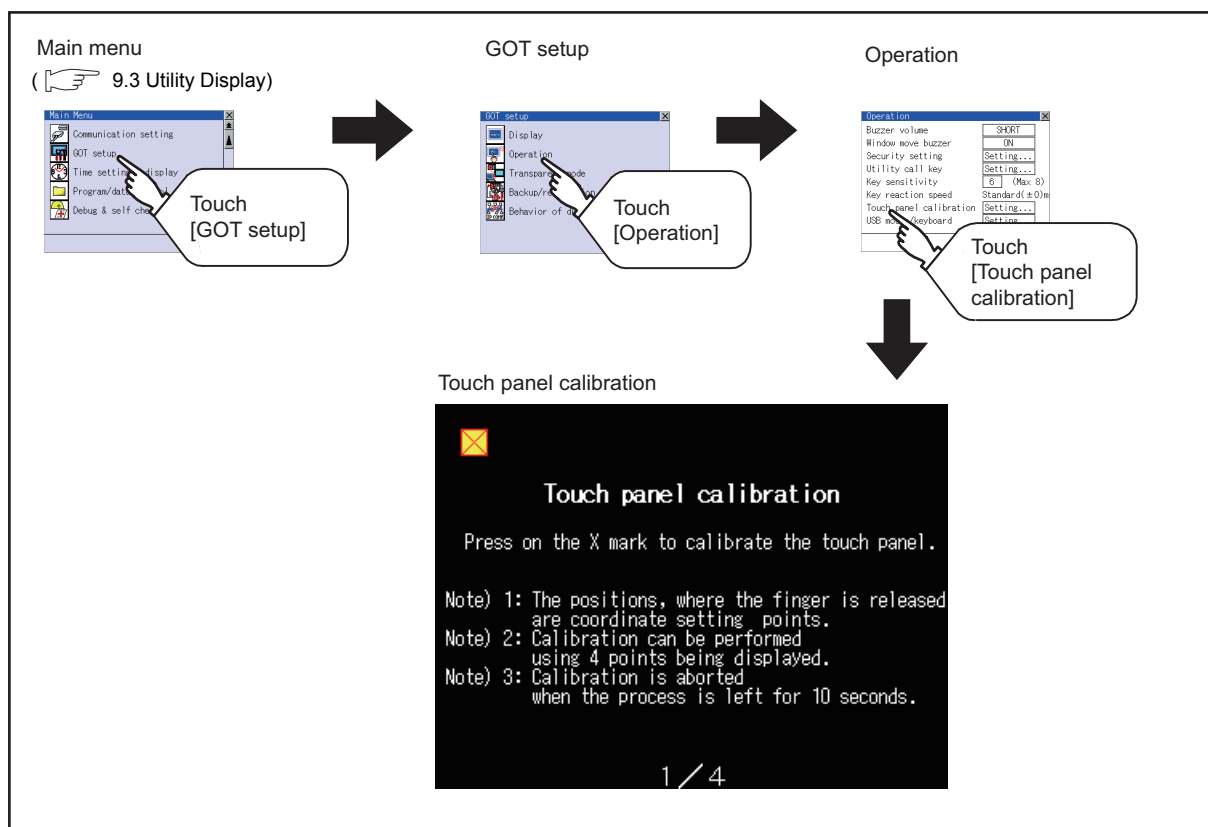

■ Touch panel calibration operation

Touch the  point displayed on the screen with the finger one by one to make the setting.



1. Touch the center of the  displayed on the upper left precisely.



2. Touch the  point displayed on the upper right.



3. Touch the  point displayed on the lower left.



4. Touch the  point displayed on the lower right.



5. Touching the  button displayed on the upper right returns the screen to the previous screen. When the precise touch could not be made, touch the [Readjustment] button to make the setting from 1. again.

11.2.7 USB mouse/keyboard setting

■ Function of USB mouse/keyboard

To install and use the USB mouse/keyboard on the GOT, set the USB mouse/keyboard.

■ Display operation of USB mouse/keyboard

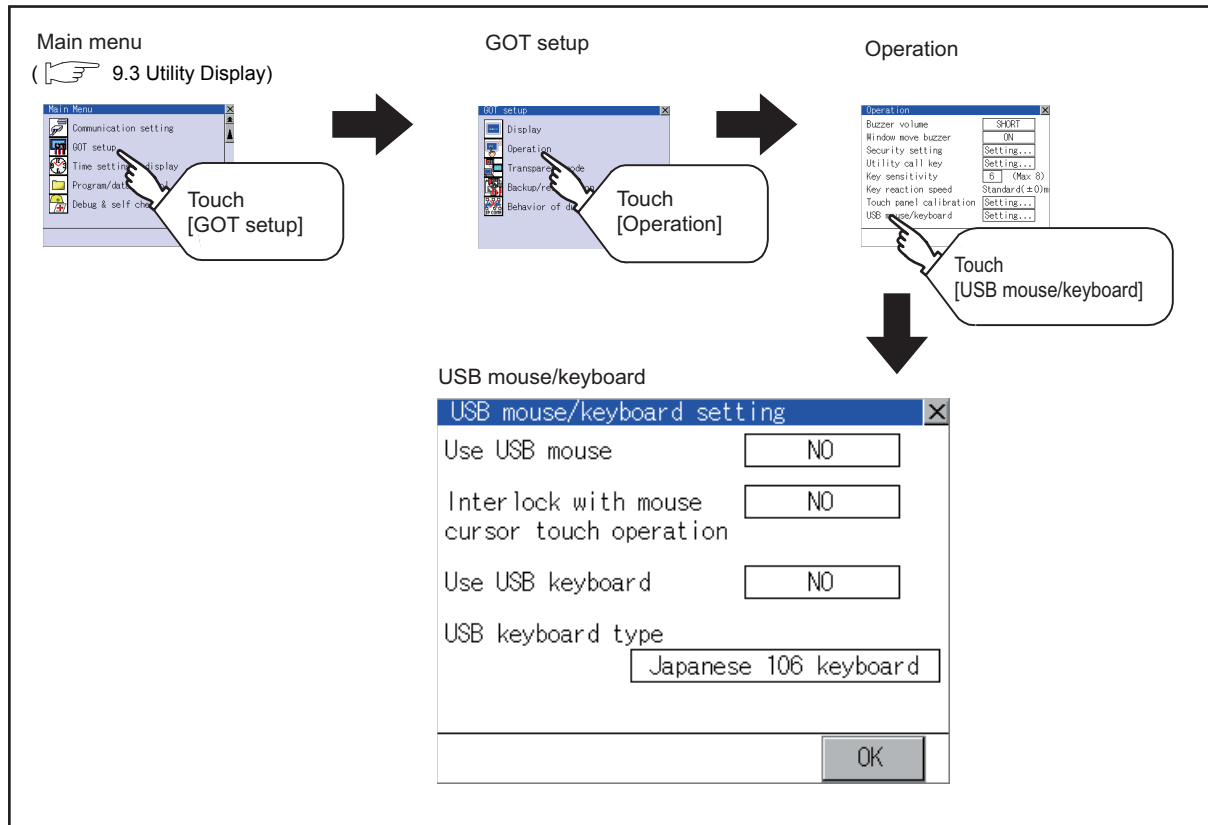

■ USB mouse/keyboard setting operation

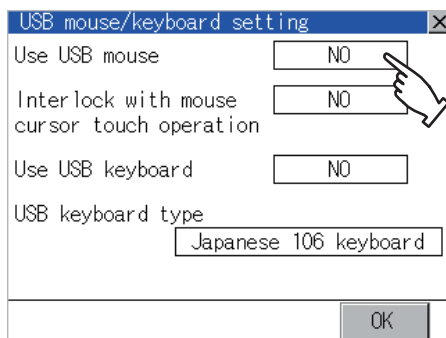

- To use the USB mouse, touch the setting item of [Use USB mouse]. The setting content is changed by touching. (YES ⇄ NO)



(Continued to next page)

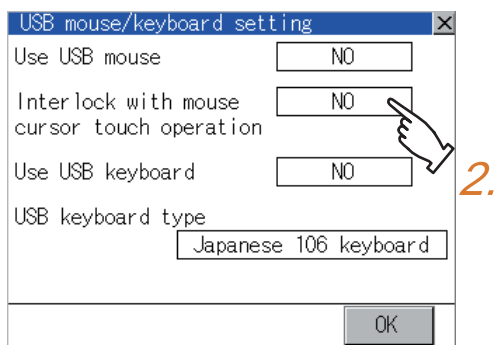

- To move the mouse cursor to the touched position, touch the setting item of [Interlock with mouse cursor touch operation]. The setting content is changed by touching. (YES ⇄ NO)

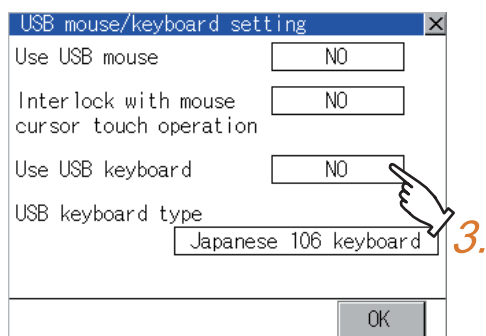

- To use the USB keyboard, touch the setting item of [Use USB keyboard]. The setting content is changed by touching. (YES ⇄ NO)

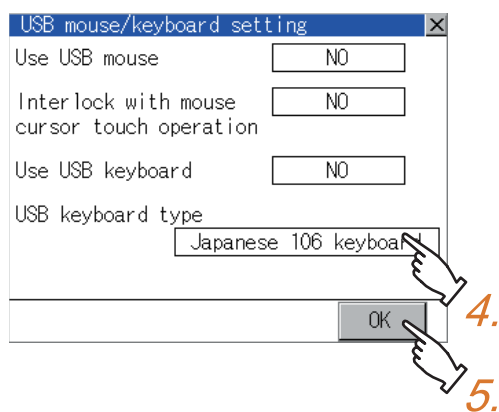

- To use the USB keyboard, touch the setting item of [USB keyboard type]. The setting content is changed by touching. (Japanese 106 keyboard ⇄ English 101 keyboard)

- Touching [OK] button defines the setting contents. Touching [×] button returns the screen to the [Operation] screen.

11.3 Transparent Mode Setting

Function of the transparent mode

When using the multi-channel function, the channel No. of a controller to which the FA transparent function is executed can be specified. For the multi-channel function and FA transparent function, refer to the following manual.

GOT1000 Series Connection Manual (Mitsubishi Products) for GT Works3

Function	Description	Setting range
Ch No.	The channel No. of a controller to which the FA transparent function is executed can be set.	1/2 (Default: 1)

Display operation of Transparent mode

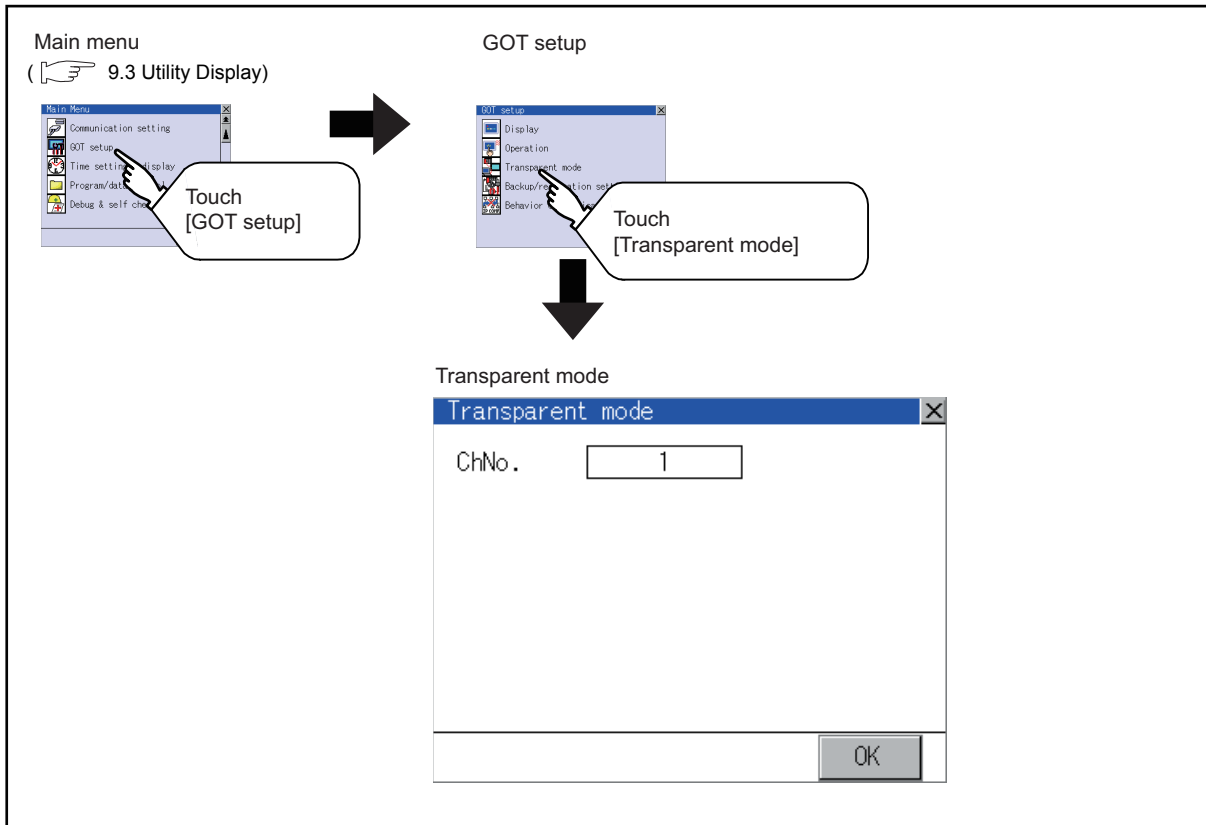

Setting operation of transparent mode

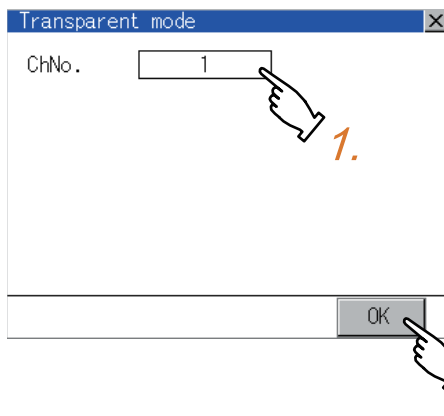

1. Touching the transparent Ch No. (numerical part) on the left displays the screen to select the communication driver. Select the channel to execute the FA transparent function.
2. Touching [OK] button defines the setting contents. Touching [x] button returns the screen to the [GOT Setup] screen.

11.4 Backup/Restoration Setting

The storage location for backup data can be set.
 For how to use the backup/restoration, refer to the following manual.

 GOT1000 Series Extended/Option Functions Manual for GT Works3

Set the following items with touching the items on the GOT.

Item	Description	Setting range
Drive for backup setting	The drive for storing backup settings, including parameters and passwords for controllers, can be selected.	A: Built-in SD Card E: USB memory (Default: A: Built-in SD Card)
Drive for backup data	The drive for storing backup data can be selected.	A: Built-in SD Card E: USB memory (Default: A: Built-in SD Card)
Trigger backup setting	The GOT automatically backs up data when triggers (Rise, Time) specified for each backup setting are met.	None/Rise/Time (Default: None)
Max. of backup data	Set the maximum number of backup data to be stored. (When 0 is specified, the GOT does not check the number of backup data to be stored.)	Setting range: 0 to 50 (Default: 10)
Enable CPU No. setting	Set the CPU No. setting at backup to "YES" or "NO".	YES/NO (Default: NO)

■ Display operation of Backup/restoration setting

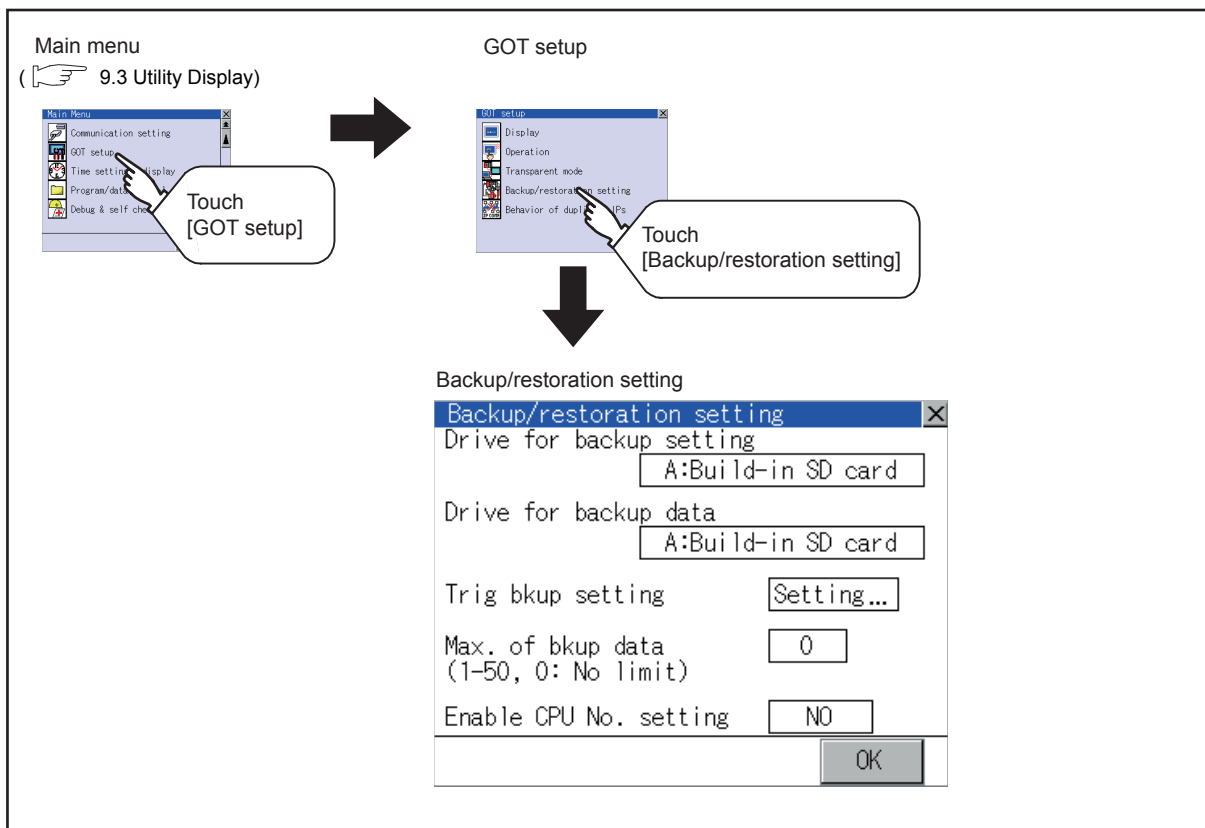

■ Setting operation of backup/restoration setting

(1) Drive for backup setting, drive for backup data

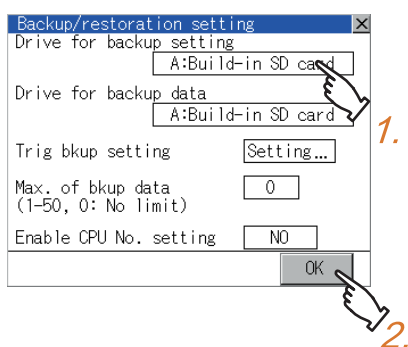

1. Touching the setting item changes the setting items.

2. Touching [OK] button defines the setting contents. Touching [x] button returns the screen to the [GOT Setup] screen.

(2) Trigger backup settings

For operations of the trigger backup setting, refer to the following.

■ Trigger backup settings

(3) Max. of backup data

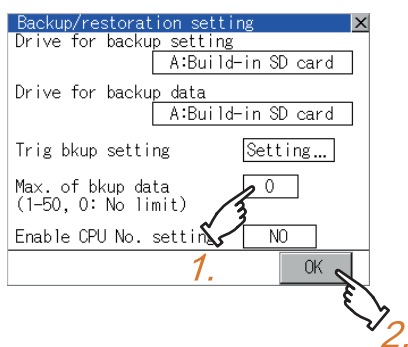

1. Touching the setting items displays the keyboard. Input numerical value from the keyboard.

Setting range: 0 to 50, Default: 10
(When 0 is specified, the GOT does not check the number of backup data to be stored.)

2. Touching [OK] button defines the setting contents. Touching [x] button returns the screen to the [GOT Setup] screen.

(4) Enable CPU No. setting

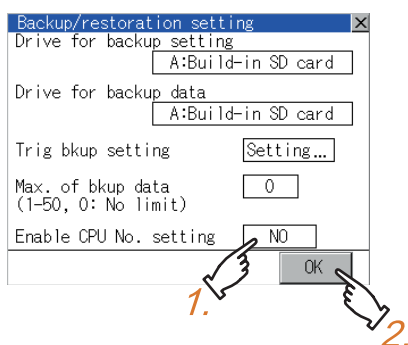

1. Touching the setting item changes the setting items.

2. Touching [OK] button defines the setting contents. Touching [x] button returns the screen to the [GOT Setup] screen.

Trigger backup settings

When the conditions of the trigger specified for each backup setting (Rise, Time) are met, the GOT automatically backs up data.

How to use the trigger backup, refer to the following manual.

 GOT1000 Series Extended/Option Functions Manual for GT Works3

Display operation of Trigger backup setting

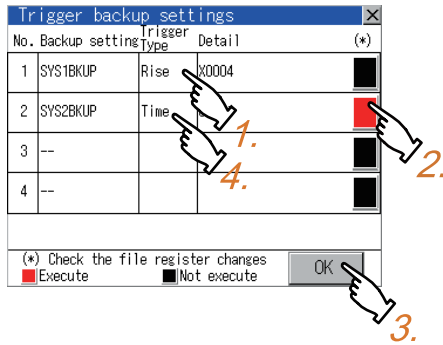

1. Touching a setting item for the trigger type changes the setting.



- None : The GOT does not execute the trigger backup.
- Rise : The GOT backs up data when the trigger device turns on.
- Time : The GOT backs up data at the specified time.

2. Touching a setting item for [Check the file register changes] changes the setting.

- Execute : When the backup is executed, the GOT checks if data stored in file registers are changed after the previous backup. When the data are changed, the GOT backs up the changed data.
- Not execute : When the backup is executed, the GOT does not back up data stored in file registers even if the data are changed after the previous backup.

3. When the trigger type is changed, the setting is defined by touching the [OK] button. Touching [X] button returns the screen to the backup/restoration setting screen.

4. When the trigger type is set to [Time], touching a setting item for [Detail] switches the screen to the trigger time setting screen. In the screen, specify the days and time that the GOT executes the backup.

- Day : Select days that the GOT executes the backup by touching displayed items. Multiple days can be selected.
- Time : Set the time that the GOT executes the backup by touching the displayed item.

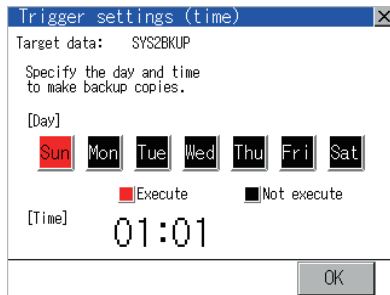

POINT

Precautions for setting

When the trigger type is set to [Rise], set the trigger device with GT Designer3 in advance. Failure to do so disables the backup setting with [Rise] set.

11.5 Behavior of Duplicate IPs

■ Setting function for Behavior of duplicate IPs

The GOT operation can be set when a device with the same IP address as that of the GOT is added to the network afterwards.

Function	Description	Setting range
Behavior of duplicate IPs	The GOT operation can be set when a device with the same IP address as that of the GOT is added to the network afterwards.	Maintain a network connection(rec) /Do not maintain a network connection (Default: Maintain a network connection (rec))

POINT

- (1) When the IP address duplication is not checked
When the IP address of the GOT is set to 192.168.0.18, the IP address duplication check is not performed. Depending on the device to connect with the GOT, the IP address duplication check may not be performed.
- (2) When the GOT is added to the network in which a device with the same IP address as that of the GOT exists
The GOT goes into offline status and displays the following dialog box.

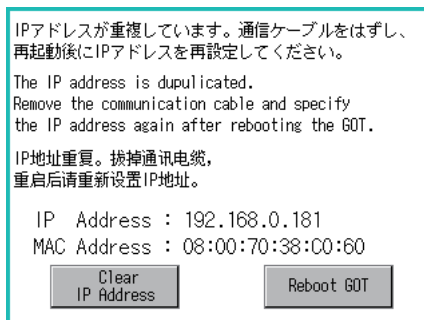

- When changing the IP address of another device which has the same IP address as that of the GOT
After changing the IP address of another device which has the same address as that of the GOT, touch the [Reboot GOT] button to restart the GOT.
- When changing the IP address of the GOT
Touch the [Clear IP Address] button to clear the IP address of the GOT.
After touching the [Reboot GOT] button to restart the GOT, change the IP address of the GOT using the Utility.

■ Display operation of Behavior of duplicate IPs

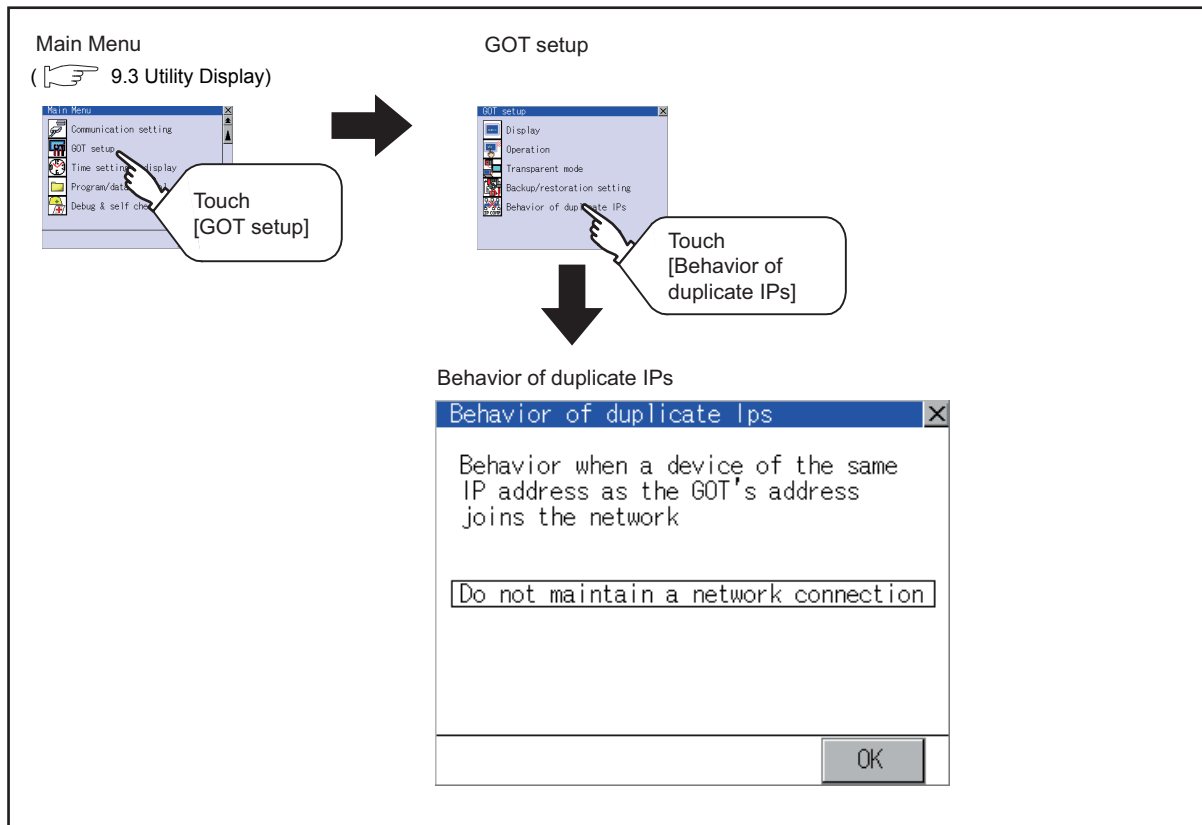

■ Setting operation of Behavior of duplicate IPs

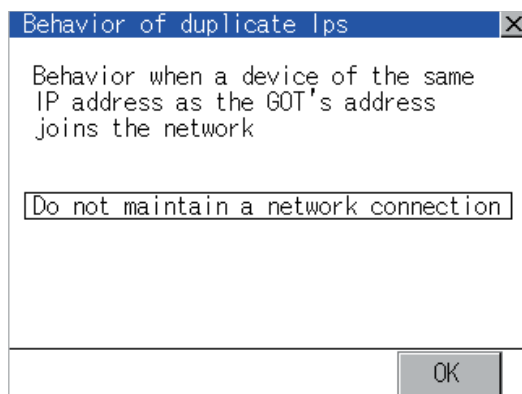

1. Touching the setting item changes the setting items.
 - Maintain a network connection (rec):
The GOT stays connected to the network when a device with the same IP address as that of the GOT is added to the network afterwards. A system alarm occurs.
 - Do not maintain a network connection:
The GOT is disconnected from the network when a device with the same IP address as that of the GOT is added to the network afterwards.
2. Touching [OK] button defines the setting contents. Touching [×] button restarts the GOT and reflects the setting contents.

POINT

- (1) Precautions for selecting [Do not maintain a network connection]
When selecting [Do not maintain a network connection], the GOT is disconnected from the network at the addition of a device with the same IP address as the GOT.
Therefore, there is a possibility that the running GOT cannot be communicated by IP address setting mistakes or intended actions by malicious users, and the system control may be influenced by those errors.
Please change the setting of [Behavior of duplicate IPs] after carefully examining the necessity.
- (2) Precautions for using a switching hub compatible with the spanning tree protocol
For the switching hub port connected with the GOT, configure the setting (PortFast or others) that makes the GOT be ready for communications (forwarding state). The setting is required to make sure that the delay right after the connection by the spanning tree protocol does not occur.
Without the setting, the Ethernet IP address duplication is not correctly detected.
Additionally, the GOT may not be connected to Ethernet correctly.
For the setting that makes the GOT be ready for communications (forwarding state), refer to the user's manual for the switching hub used.

9	UTILITY FUNCTION
10	COMMUNICATION INTERFACE SETTING (COMMUNICATION SETTING)
11	DISPLAY AND OPERATION SETTINGS (GOT SET UP)
12	CLOCK SETTINGS AND BATTERY STATUS DISPLAY (TIME SETTING AND DISPLAY)
13	FILE DISPLAY AND COPY (PROGRAM/DATA CONTROL)
14	GOT SELF CHECK (DEBUG AND SELF CHECK)
15	CLEANING DISPLAY SECTION (CLEAN)
16	INSTALLATION OF COREOS, BOOTOS AND STANDARD

12. CLOCK SETTINGS AND BATTERY STATUS DISPLAY (TIME SETTING AND DISPLAY)

Setting items for clock display can be displayed from the GOT utility screen.

12.1 Time Setting and Display

12.1.1 Time setting and display functions

Time settings and displaying of the status of GOT built-in battery are possible.

Function	Description	Reference
Clock setting	Setup the method to adjust the time between GOT clock data and clock data of PLC CPU connected with GOT.	12-2
Clock display	Carry out the display and setup of GOT clock data.	12-3
GOT internal battery voltage status	Displays GOT internal battery voltage status.	12-3

POINT

Changing times

When the time is changed on the Time setting & display screen, the changed time is written in a programmable controller even though [Adjust] or [Broadcast] is set for [Time setting].

As a result, the time of the programmable controller can be changed on the GOT even though [Adjust] is set for [Time setting].

(The clock data of the controller set as [Adjust CH No.] of [Time setting] in [GOT Setup] ([Clock Setting]) from [GOT Environment Settings] of GT Designer3 is changed.)

For details of [Adjust] and [Broadcast], refer to the following manual.

 GT Designer3 Version1 Screen Design Manual (Fundamentals)

■ Display operation of time setting

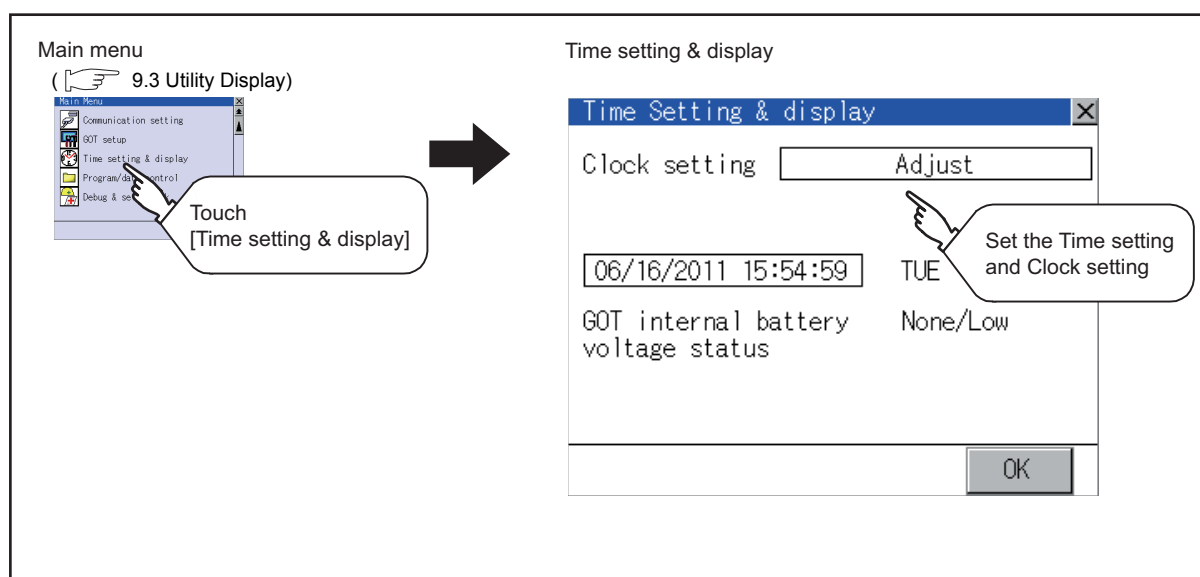

■ Operation of time setting

(1) Clock setting

Setup the method to adjust the time between GOT clock data and the clock data of controller connected to the GOT.

It is same as set in the GOT setup in Environmental Setting of GT Designer3.

 GT Designer3 Version1 Screen Design Manual (Fundamentals)

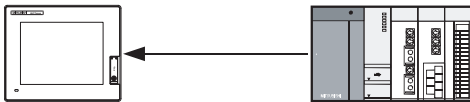
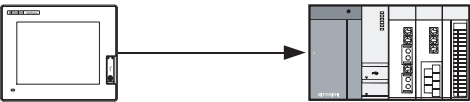
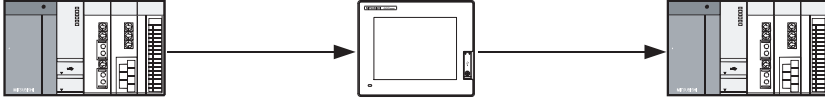
Setting	Description
Adjust	Adjust the time of GOT clock data to the clock data of controller. 
Broadcast	Adjust the time of controller clock data to the GOT clock data. 
Adjust/Broadcast	Adjust the GOT and controllers to the controller whose clock data is used as a base. 
None	No adjustment of clock data.

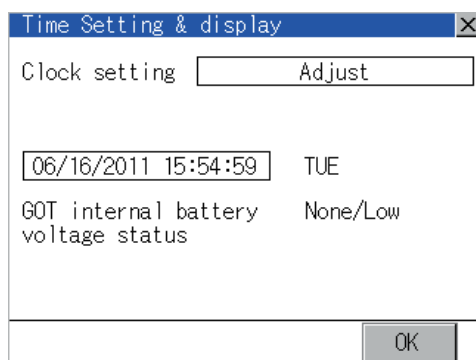

1. Touching the setup item changes the setup contents.



2. Touching [OK] button reflects the setup contents. Touching the [×] button restarts the GOT. After restarting, the GOT operates with the changed setting.

POINT

- When connecting with an external device which does not have clock function.
If set to [Adjust] or [Broadcast] for [Clock setting] while the GOT is connected with external devices (PLC or microcomputers) which do not have clock function, the clock data will not be adjusted.
For the list of PLC installed with clock function, refer to the following.

 GOT1000 Series Connection Manual for GT Works3

- Setting of clock setting and battery
When selecting [Broadcast] or [None] in clock setting, set the clock of the GOT once with connecting a battery to the GOT.
- Operation setting by GT Designer3
Carry out the setting of clock setting in [GOT set up] in [Environmental Setting] of GT Designer3.
To change a part of the setting after downloading the project data, change the setting at the display setting of GOT.

 GT Designer3 Version1 Screen Design Manual (Fundamentals)

- (2) Clock display
Carry out the display and setting of GOT clock data.
The setup methods of clock data are shown below.

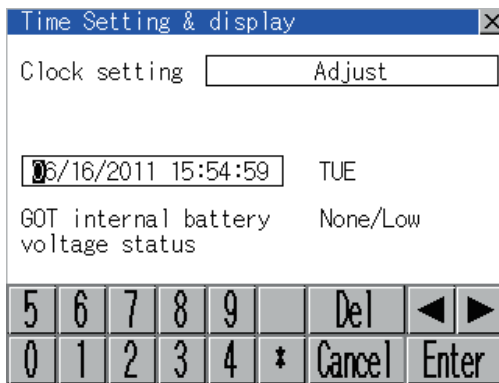

1. Touching the clock display section displays the keyboard for input and stops the clock update.
2. Input time with the keyboard by referring to the table below.
Input the scheduled time when the operation of 3. is to be carried out since the input time is reflected at the time of the operation of 3..
The day of the week is displayed automatically according to the input date.
The effective range of clock setting is as follows.
Jan. 1, 2000 to Dec. 31, 2037

Key	Description
0 to 9	Input numeric value in cursor position.
◀ / ▶	Move the cursor.
Del	Move the cursor to the left by one character when [Del] Key is touched while inputting year, month, day, time, minutes, seconds. Carry out nothing when touched other than when inputting the above.
Enter	Close the keyboard after the input time is displayed in clock display. The update of the clock display does not restart even if the keyboard is closed. The update of the clock display restarts with the operation of 3. .
Cancel	Cancel the input time and returns the time of clock display to the time at which the keyboard was displayed and close the keyboard. The update of the clock display does not restart even if the keyboard is closed. The update of the clock display restarts with the operation of 3. .

3. Touching the [OK] button reflects the settings and restarts updating the clock display.
Then, the settings are reflected to both clock data on the GOT and controller.

Touching [×] button restarts the GOT if the clock settings is changed, or closes the screen if clock settings is not changed.

- (3) GOT internal battery voltage status
Displays battery voltage status.

Display	Status
Normal	Normal
Low/None	Low voltage

When the battery voltage is low, replace the battery immediately.
For battery replacement procedure, refer to the following.

 8.3.3 Battery replacement procedure

13. FILE DISPLAY AND COPY (PROGRAM/DATA CONTROL)

The display of OS, project data or alarm data which is written in the GOT or SD card and the data transmission between GOT and SD card/USB memory are possible.
The format of the SD card/USB memory is also possible.

13.1 Data Storage Location

13.1.1 Data type and storage location

System

The data storage location and transferring (write/read) route for each data type are shown below.
Also, the data storage locations are shown below.

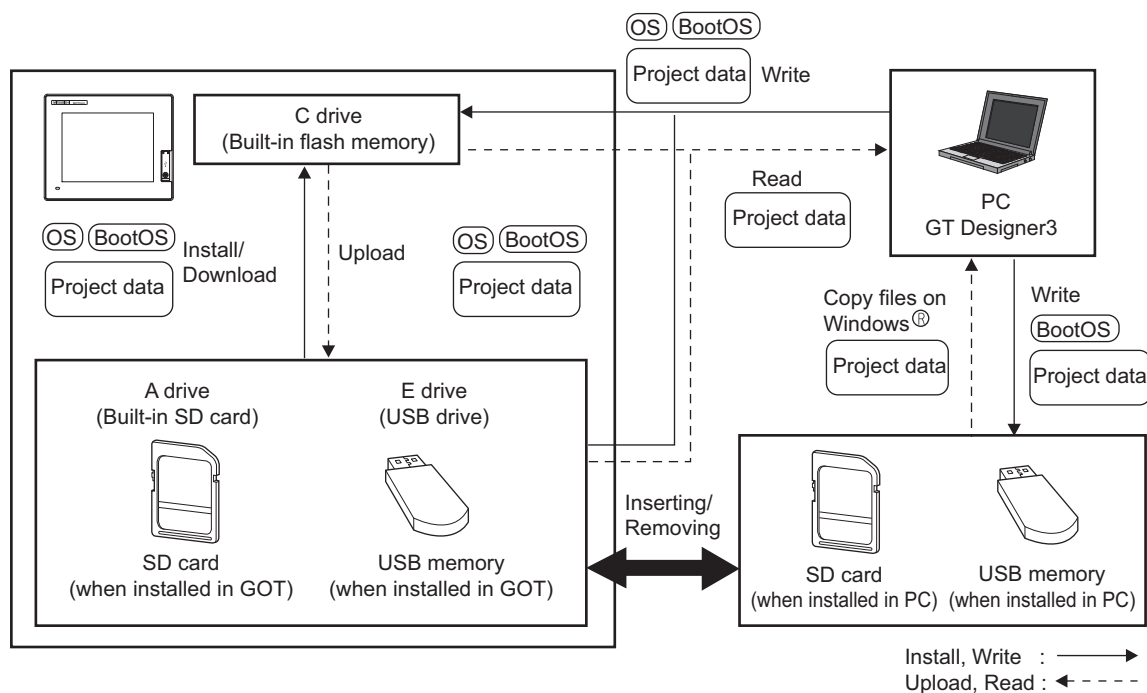

The data of the Flash Memory (Project data, etc.) can be saved even if the battery voltage becomes low.

Item	Data type	Storage location
OS (BootOS)	BootOS	Built-in flash memory (C drive)
OS *1	Standard monitor OS	Built-in SD card (A drive)
	Communication driver	
	Extended function OS	Built-in flash memory (C drive)
	Option OS	*2
Project data *1	Project data (Including recipe setting, alarm conditions, time action, and GOT setup.)	Built-in SD card (A drive) Built-in flash memory (C drive) *2

*1 The USB memory can be used from Utility.

16.3.2 Installing using the program/data control function (Utility)

*2 When using the project data stored in the built-in SD card (A drive) with the GOT, hold the SD card installed to the GOT. The USB memory cannot be activated directly from the E drive. It can be used only for data storage.

■ At maintenance

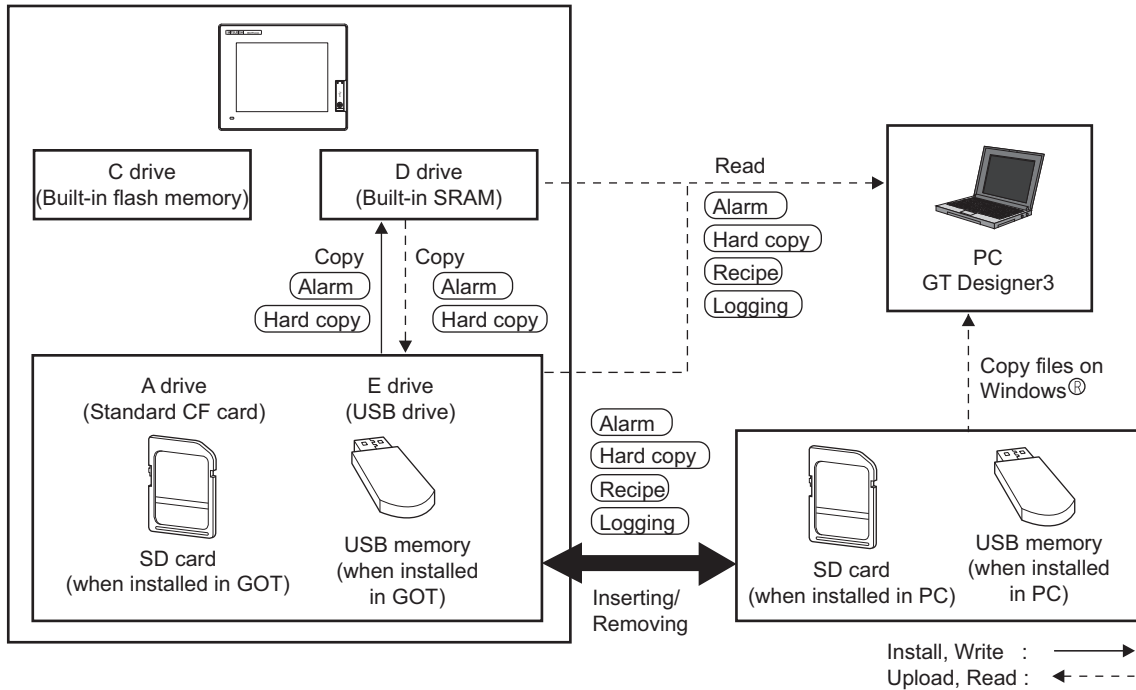

Item	Data type	Storage location
Alarm	Alarm data (Extended alarm log file and alarm log file)	Built-in SD card (A drive) Internal SRAM (D drive) USB drive (E drive)*1
Recipe	Recipe data (Advanced recipe file, Recipe file)	
Logging	Logging (Logging file)	
Hard copy	Image file (Hard copy function)	

*1 The USB memory can be used from Utility.

POINT

Checking the available memory of storage location

When saving resource data, check available memory of storage location before use.

Memory capacity of internal SRAM (D drive) is 512kbytes. Use the built-in SD card (A drive) if the available memory is not enough.

13.1.2 OS version confirmation

Confirm the OS version carefully when install BootOS and Standard monitor OS.
When OS is installed, GOT checks and compares the OS version automatically.

- (1) When install BootOS
When the BootOS to be installed has the older major version, GOT displays the installation disapproving message to cancel the installation so that the older version may not be written.
(Even when the version of the BootOS to be installed has the same or later version, the version information and the dialog for selecting continue/not continue will be displayed.)
Depending on the Installation method, the dialog box to be displayed varies.
 - When installing from the built-in SD card, the dialog box is displayed by the main unit.
 - When installing from GT Designer3 via USB or Ethernet, the dialog box is displayed by the GT Designer3
- (2) When install Standard monitor OS, communication driver, Option OS
When Standard monitor OS, communication driver, or Option OS has already been installed, the version information of the OS which has been installed and the dialog for selecting continue/not continue will be displayed.
Moreover, when the different versions will coexist among all OSs (Standard monitor OS, communication driver, and Option OS) by installing OS, the installation disapproving dialog will be displayed and the installation process is canceled.
- (3) When download project data
GOT automatically compares the version between the project data to be downloaded and the installed OS.
When the versions are different, the dialog confirming whether to install the OS together is displayed.
When downloading the project data from the SD card or USB memory, storing the project data and OS beforehand is recommended.
The version of each OS installed in the GOT can be confirmed by [Property] of [OS information] screen.

Property			
Name	Date	Time	
OS Name	Kind	Version	Size
G10SMONT.OUT Standard monitor OS	Basic	05.27.60	1355K
G1F16SLG.FON 16dot Gothic(Japanese/Europe)	Basic	05.27.00	500K
G1F12SLG.FON 12dot Font(Japanese/Europe)	Basic	05.27.00	407K
G10SMONT.G1D System Screen Information	Basic	05.27.61	3K

Explanation of OS version
01.00.00.A
 └─ BootOS version
 (Appears only when the property of the BootOS is displayed.)
 └─ Minor version
 └─ Major version

For details of the screen display operation, refer to the following.

➔ 13.2.1 OS information

POINT

Version confirmation of BootOS by rating plate

Check the version of BootOS installed in GOT at product shipment on the rating plate on GOT rear face.

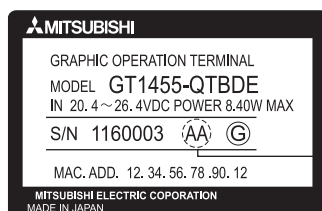

AA
BootOS
Version

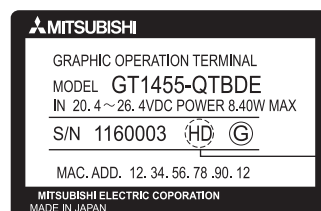

HD
BootOS
Version

When the Boot OS version is 2 digits, only the lower digit is printed.

Example H/W version: H
Boot OS version: AD

Rating plate: HD

13.1.3 Capacity confirmation of the project data downloading location

When download the project data, confirm the capacity of the user area in the drive to which transferred, the transferred project data size, the transfer size and buffering area size of the optional function OS in advance to judge whether to carry out the download.

The capacities can be confirmed by GT Designer3. For details, refer to the following.

 GT Designer3 Version1 Screen Design Manual (Fundamentals)

13.1.4 Display file

The display screen and storage destination for each type of data are shown below.

The file name and contents of each data can be displayed with property display of the utility

Item		Display screen	Storage destination (Drive name/folder name)
BootOS			A drive/C drive/E drive : \G1BOOT* ²
Standard monitor OS	Standard monitor OS system screen data	OS information screen	A drive/C drive/E drive ³ : \G1SYS* ²
	Standard monitor OS system screen management information file		
	Standard monitor OS (monitor function)		
	6 × 8-dot font (ASCII characters)		
	24-dot numerical HQ font		
	32-dot numerical HQ font		
	TrueType numerical font		
	12-dot standard font		
16-dot standard font			
Extended function OS			
Option OS			
Communication driver			
Project data ^{*1}		Project information screen	A drive/C drive/E drive ³ : \PROJECT1* ^{2,4}
User-created screen data			
Comment data			
12-dot HQ fonts (Mincho/Gothic)			
16-dot HQ fonts (Mincho/Gothic)			
TrueType (Mincho/Gothic)			
Resource data	Advanced alarm log file CSV file ^{*5}	Alarm information screen	A drive/D drive/E drive ^{*6} : \ With GT Designer3, any folder name or file name can be specified. ^{*2}
	Advanced alarm log file TXT file ^{*5}		
	Advanced alarm log file binary file ^{*5}		
	Alarm log file CSV file ^{*5}		
	Hard copy file BMP file ^{*5}	Hard copy information screen	
	Hard copy file JPG file ^{*5}		
	Advanced recipe file CSV file ^{*5}	Advanced recipe information screen	
	Advanced recipe file TXT file ^{*5}		
	Advanced recipe file binary file ^{*5}		
	Logging file CSV file ^{*5}	Logging information screen	
	Logging file TXT file ^{*5}		
Logging file binary file ^{*5}			

*1 The user-created screen data, comment data, and font data are displayed as project data.

*2 Each folder is created automatically when a file is installed, downloaded, or uploaded.

*3 The USB memory cannot be activated directly from the E drive. It can be used only for data storage.

 13.2.1 OS information

*4 The folder names and file names can be set at [System Settings] in [System Environment] of GT Designer3.

 GT Designer3 Version1 Screen Design Manual (Fundamentals)

*5 A serial number is automatically added to file names.

*6 Each function does not provide direct storage to the E drive.

13.2 Various Data Control

13.2.1 OS information

Function of OS information

Each file name/folder name of BootOS and OS (Standard monitor OS, PC communication driver and Option OS) by which each drive (A: Built-in SD card, C: Built-in flash memory, E: USB memory) holds can be displayed in lists. Installation and uploading of the files are also possible.

Function	Description	Reference
Displaying file, folder data	The file/folder type, name, data size and creating date & time are displayed.	13-6, 13-7
Install	All OS files written in the A drive (Built-in SD card)/E drive (USB drive) can be installed in the C drive (Built-in flash memory).	13-8
Upload	All OS files in the C drive (Built-in flash memory) can be uploaded to the A drive (Built-in SD card)/E drive (USB drive).	13-9
Property display	Displays the property (file name, data size, type, version and creation date) of the file.	13-10
Data check	Data check of files is possible.	13-10

POINT

- (1) Notes on installing OS
If the Boot OS or the Standard monitor OS is installed, such data on the GOT as the project data will be deleted.
After installing the Boot OS or the Standard monitor OS, reinstall/download necessary data.
- (2) Notes on handling OS files
When the OS boot drive is set to [A: Built-in SD card], installing and uploading OS files are not available.

Display operation of OS information

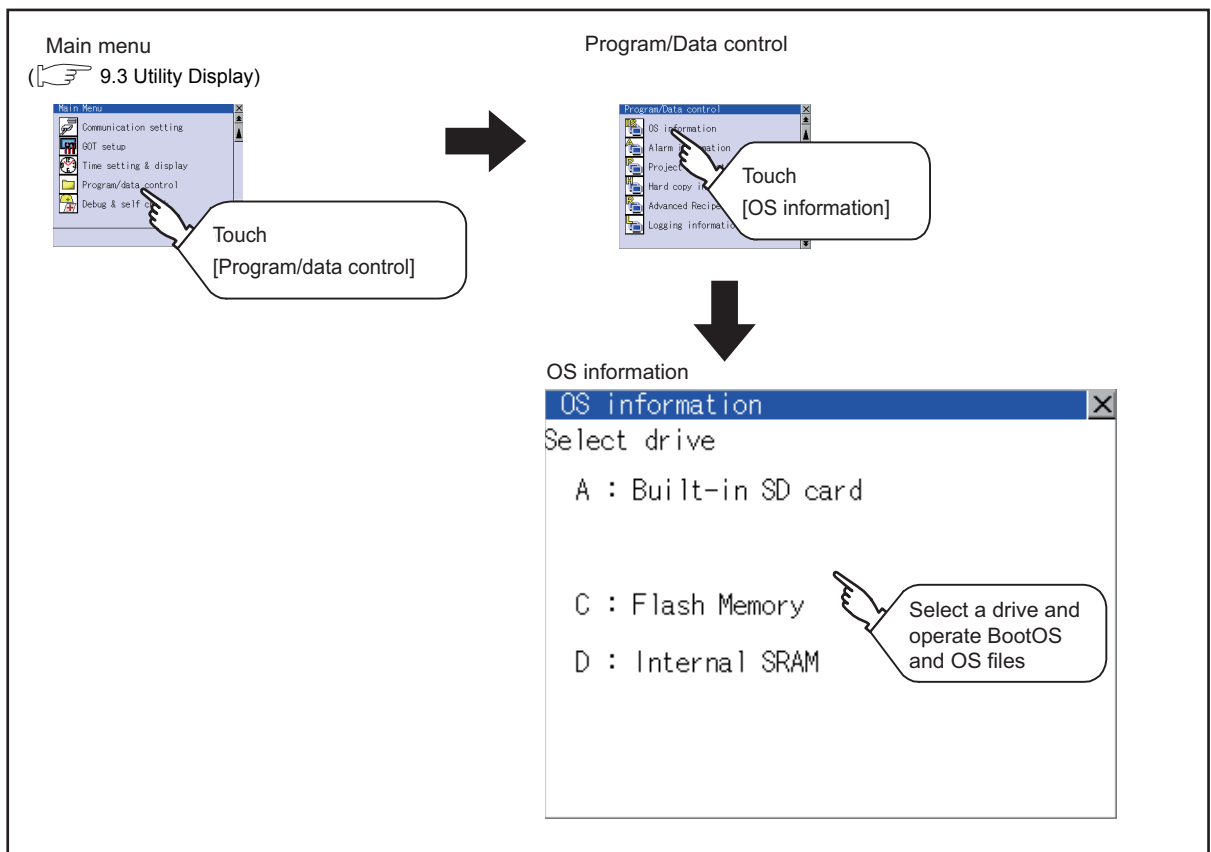

■ Display example of OS information

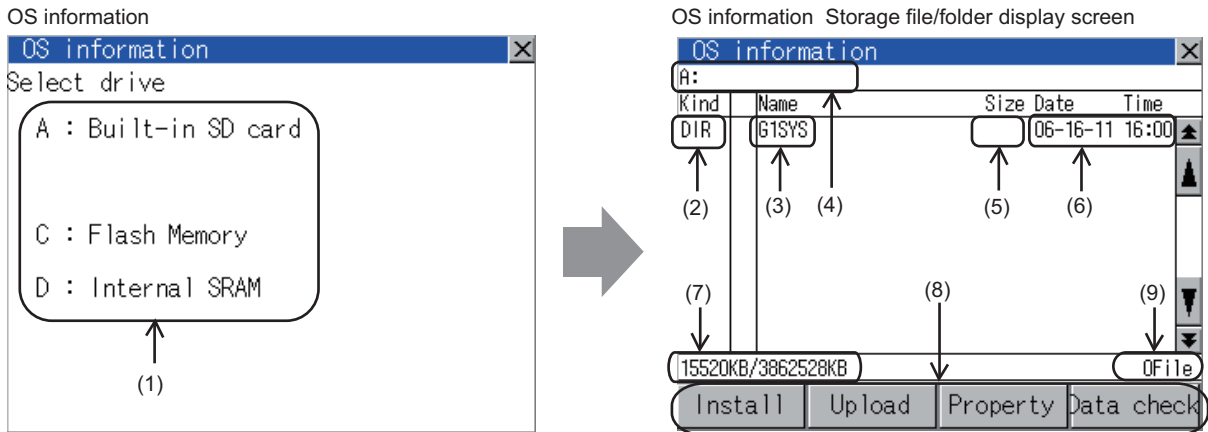

Number	Item	Description
(1)	Select drive	The target drive which displays file or folder can be selected. When the SD card is not installed, [A:Built-in SD card] is not displayed. If the USB memory is not installed, [E: USB drive] is not displayed.
(2)	Kind	Indicates the type of the displayed name (file or folder). In case of file, displays the extension; in case of folder, displays "DIR".
(3)	Name	The file name or folder name which is stored in the selected drive or folder is displayed. When the file name or folder name exceeds 20 characters, the exceeding characters (the 21st character or after) are not displayed.
(4)	Path name	Displays the path name of drive/folder which is currently displayed.
(5)	Size	Displays the size of the file displayed in [Name].
(6)	Date and time	The date and time when each file was created are displayed.
(7)	The size of drive	Displays the size in use and the entire size of the drive which is selected by drive selection. (Only the size in use is displayed when selecting the C drive.)
(8)	Operation switch	Execution switch of each function.
(9)	Number of files	Displays the total number of the displayed files.

POINT

Folders and files displayed

For the folders and files displayed, refer to the following.

☞ 13.1.4 Display file

■ OS information operation

(1) Display operation of OS information

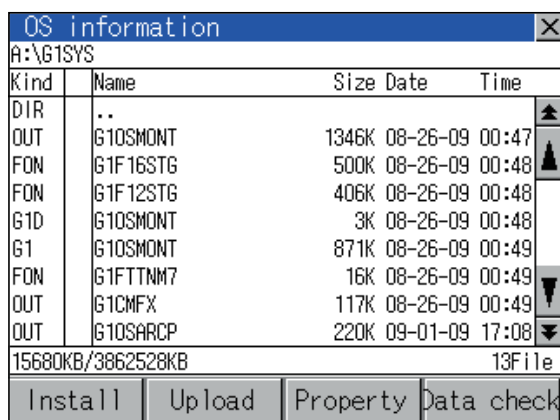

1. Touching a drive in [Select drive] displays the information of the first folder of the touched drive.
2. Touching a folder name displays the information of the touched folder.
3. Touching a folder name of [. .] displays the information of the folder in one upper hierarchy.
4. Touching ▲▼ button of the scrollbar scrolls up/down the screen by one line.
Touching ▲▼ button scrolls up/down the screen by one screen.
5. Touching a file name selects and inverts the file.
6. For operation of installation, upload, property, data check, refer to the following.
Install.....☞ This section (2)
Upload.....☞ This section (3)
Property.....☞ This section (4)
Data check.....☞ This section (5)
7. [Touching [x] button closes the screen.

(2) Installation operation

BootOS and OS which are written in the A drive (built-in SD card) or E drive (USB drive) can be installed in GOT.
(This item explains using the A drive.)

1. Install the SD card to which the BootOS or OS to install is written to the GOT.
For inserting/removing method of SD card/USB memory, refer to the following.
 8.1.2 Installing and removing procedures of the SD card
8.2.2 Installing and removing procedures of the USB memory
2. Touch [A: Built-in SD card] of [Select drive].

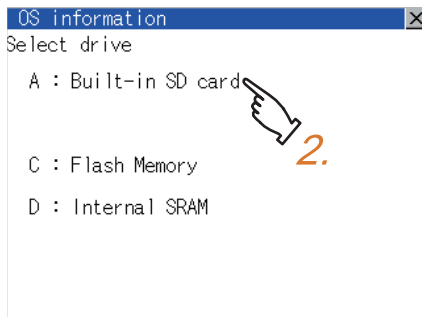

3. Touching [Install] button starts the install.

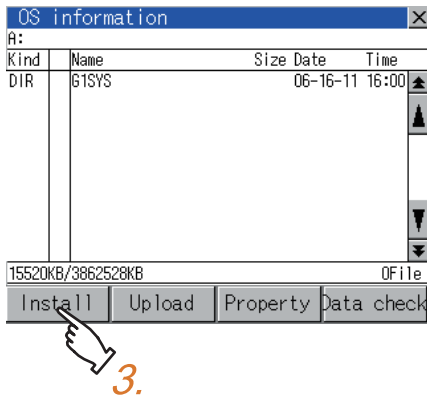

4. When the installation is completed, the dialog shown left is displayed.
Touching [OK] button restarts GOT.

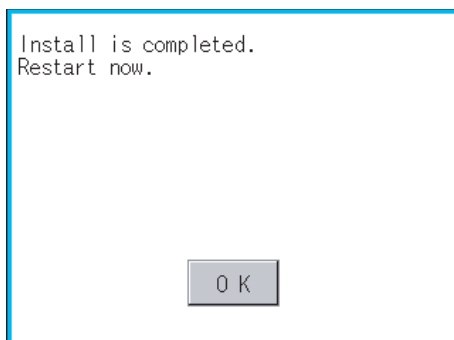

(3) Upload operation

BootOS and OS in the C drive (Flash Memory) can be uploaded to the A drive (Built-in SD card) and E drive (USB drive).

The SD card after uploading can be used for installing the OS on another GOT.

 16. INSTALLATION OF COREOS, BOOTOS AND STANDARD MONITOR OS

(This item explains using the A drive.)

1. Install the SD card used as the uploading destination to GOT.
For inserting/removing method of SD card/USB memory, refer to the following.

 8.1.2 Installing and removing procedures of the SD card
8.2.2 Installing and removing procedures of the USB memory

2. Touch [A: Built-in SD card] of [Select drive].

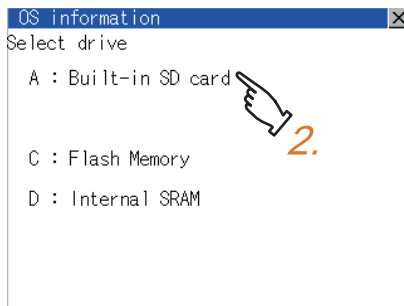

3. Touching [Upload] starts the uploading.

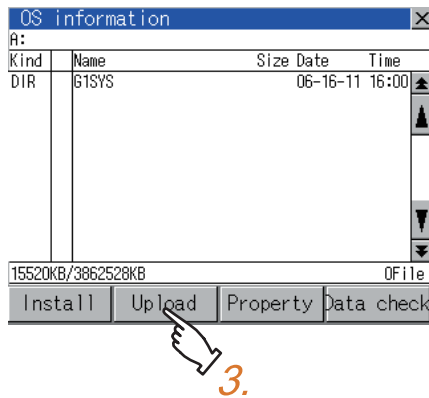

4. When the upload is completed, the dialog shown left is displayed.
Touching [OK] button closes the dialog.

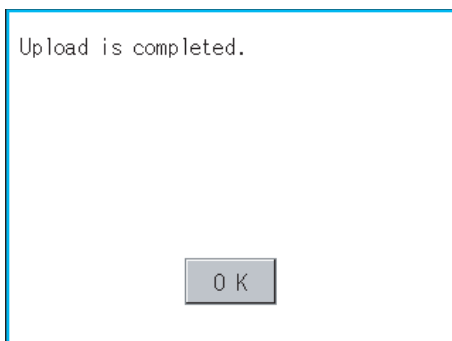

(4) Property display operation

Displays the property of the file stored in the selected folder.

Name	OS Name	Kind	Version	Size	Date	Time
G10SMONT.OUT	Standard monitor OS	Basic	05.27.60	1355K	06-16-11	11:17
G1F16SLG.FON	16dot Gothic(Japanese/Europe)	Basic	05.27.00	500K	06-16-11	11:17
G1F12SLG.FON	12dot Font(Japanese/Europe)	Basic	05.27.00	407K	06-16-11	11:17
G10SMONT.G1D	System Screen Information	Basic	05.27.61	3K	06-16-11	11:17

1. Touching [Property] button after selecting the property displaying target folder displays the [Property] screen shown left. In the [Property] screen, the following information is displayed for each file selected by 1.

Item	Description
Name	Displays the file name.
Size	Displays the file size.
Kind	Displays the following items according to the kind of the files. Boot: BootOS Basic: Standard monitor OS Extend: Extend function OS Option: Optional function OS Comm.: Communication driver
Version	Displays the version of BootOS and OS.
Date, Time	Displays the date and time of the file creation.

2. Touching ▲ ▼ button of the scrollbar scrolls up/down the screen by one line.

Touching ▲ ▼ button scrolls up/down the screen by one screen.

3. Touching [×] button returns the screen to the previous screen display.

(5) Data check operation

Carries out data check of the selected system file.

When data is normal.

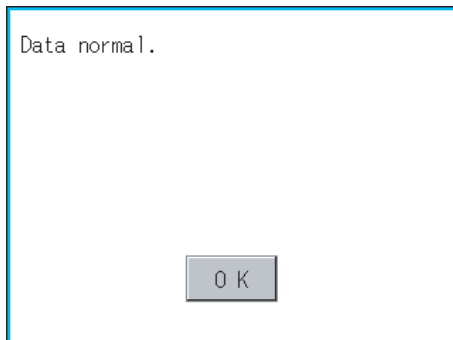

When data is erroneous.

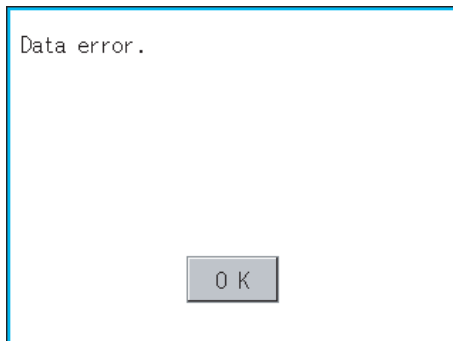

1. Touch [Data check] button after selecting a data check target file. The dialog mentioned left will be displayed after executing data check.
2. Touching [OK] button closes the dialog.

13.2.2 Alarm information

■ Function of alarm information

The extended alarm log file or alarm log file held by each drive (A: Built-in SD card, C: Flash Memory, D: Internal SRAM, E: USB drive) is displayed.

The functions below can be carried out for files.

The USB drive only stores log files, and cannot be displayed.

For details of Advanced Alarm, refer to the following manual.

 GT Designer3 Version1 Screen Design Manual (Functions)

Function	Description	Reference
Displaying file, folder data	The file/folder name, data size and creating date & time are displayed.	13-12, 13-13
G1A → CSV conversion	Converts the G1A file of advanced alarm log file to CSV file.	13-14
G1A → TXT conversion	Converts the G1A file of advanced alarm log file to TXT file.	13-14
Delete	File is deleted.	13-15
Copy	File is copied.	13-16

■ Display operation of Alarm information

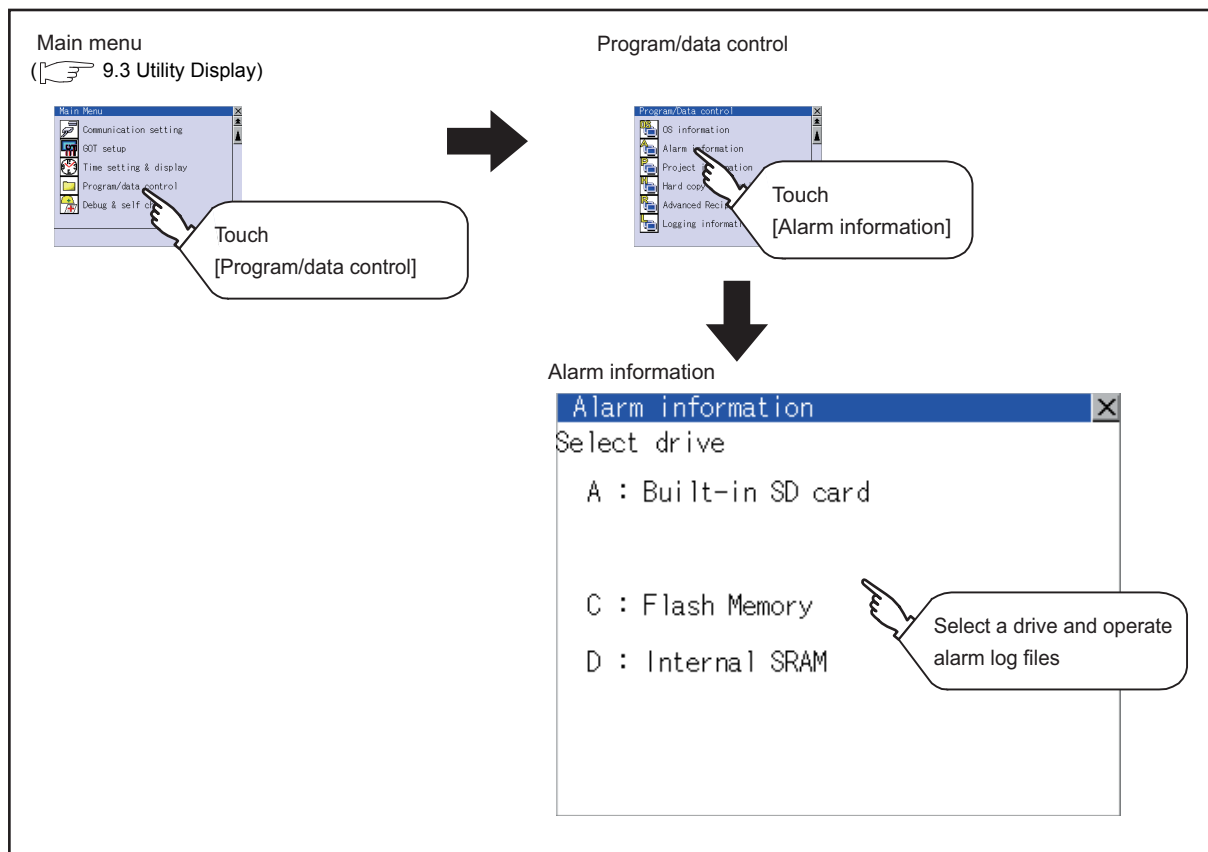

■ Display example of Alarm information

Alarm information screen

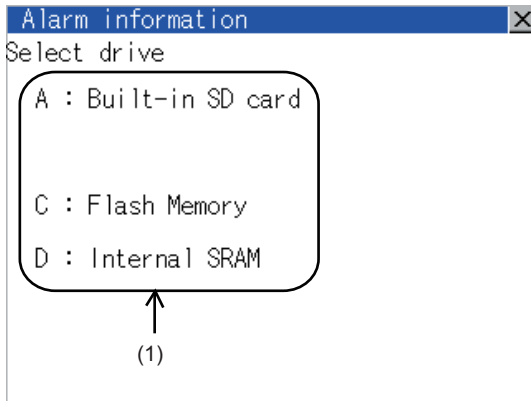

Alarm information: Storage file/folder display screen

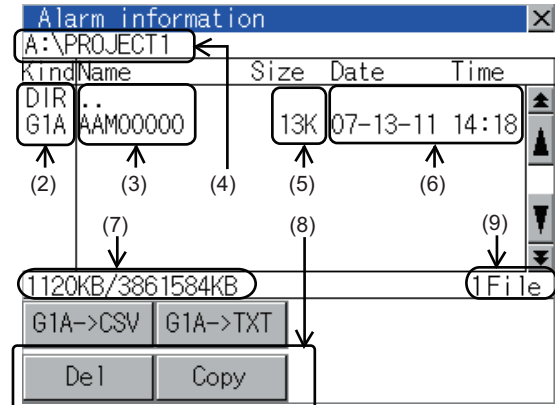

Number	Item	Description
(1)	Select drive	The target drive which displays file or folder can be selected. When SD card or USB memory is not installed, the following drives are not displayed. • SD card: [A: Built-in SD card] • USB memory: [E: USB drive]
(2)	Kind	Indicates the type of the displayed name (file or folder). The file is indicated with an extension, while the folder is indicated with "DIR."
(3)	Name	Displays the file name or folder name. For the long file/folder name, entire part may not be displayed. Confirm the nondisplayed part with the [Copy] button, etc. (☞ 13.2.2 ■ Alarm information operation(4)Copy operation) After confirmation, touch the [Cancel] button to cancel the operation.
(4)	Path name	Displays the path name of drive/folder which is currently displayed.
(5)	Size	Displays the size of the file displayed in [Name].
(6)	Date and time	The date and time when each file was created are displayed.
(7)	The size of drive	Displays the size in use and the entire size of the drive which is selected by drive selection. (Only the size in use is displayed when selecting the C drive.)
(8)	Operation switch	Execution switch of each function.
(9)	Number of files	Displays the total number of the displayed files.

POINT

- (1) Display of creation date and time
The creation date and time display is not updated even if a file is created or updated while displaying the alarm information display screen.
If close the screen currently displayed (moving the screen to the folder of the upper hierarchy, etc.) and display the screen again, the updated contents are displayed.
- (2) Folders and files displayed
For the folders and files displayed, refer to the following.

☞ 13.1.4 Display file

Alarm information operation

(1) Display operation of Alarm information

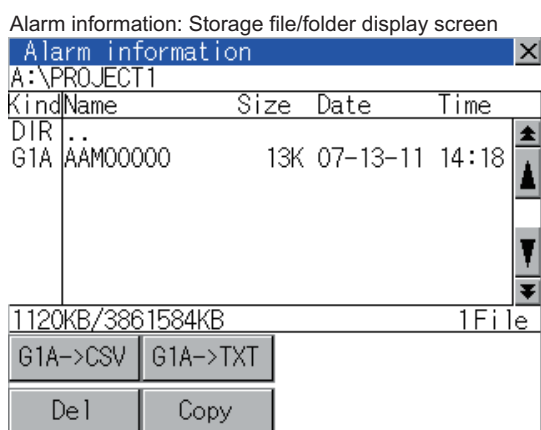
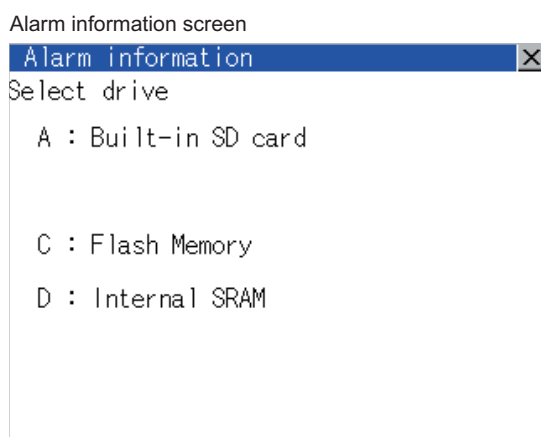

1. Touching a drive of [Select drive] displays the information of the touched drive.
2. Touching a folder name displays the information of the touched folder.
3. Touching a folder of [. .] displays the information of the folder of the one upper hierarchy.
4. Touching ▲▼ button of the scrollbar scrolls up/down the screen by one line.

Touching ▲▼ button scrolls up/down the screen by one screen.
5. Touching a file name selects the file.
6. For G1A → CSV, G1A → TXT, delete, copy, graph operations, refer to the following.
G1A → CSV, G1A → TXT.....☞ This section (2)
Delete.....☞ This section (3)
Copy.....☞ This section (4)
7. Touching [×] button closes the screen.

- (2) G1A → CSV conversion operation, G1A → TXT conversion operation
The selected G1A file is converted to CSV file or TXT file.

(Example: When [G1A → CSV] button is touched)

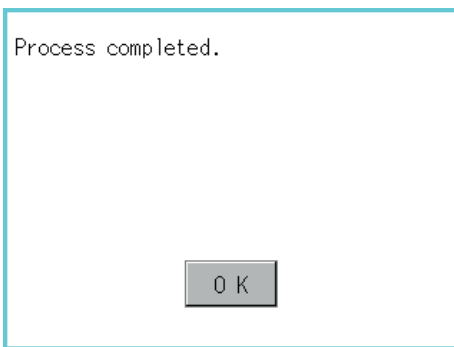
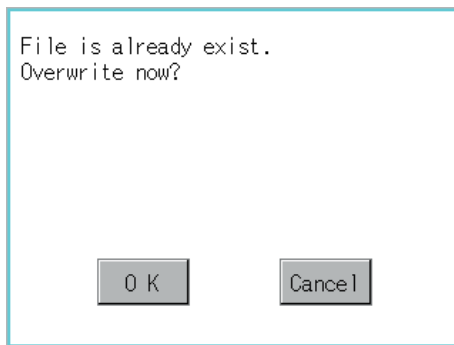
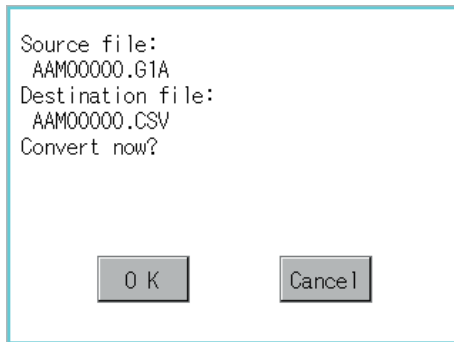

1. Touch and select the G1A file to convert into a CSV file or a TXT file.

2. The following dialog box is displayed when touching the following button according to the file type to convert to.
 - CVS file: [G1A → CSV] Button
 - TXT file: [G1A → TXT] Button

3. Touch [OK] button.
When the file, whose name is the same, exists in the destination folder, the dialog box shown at left appears without starting the conversion. Touching [OK] button overwrites the file. Touching [Cancel] button cancels the conversion.

4. The message of completion is displayed in dialog box when conversion is completed. Touching [OK] button closes the dialog.

- (3) Deletion operation
Deletes selected files.

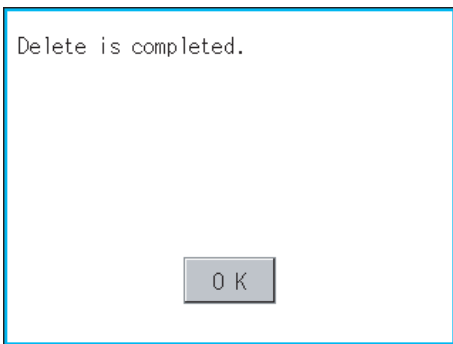
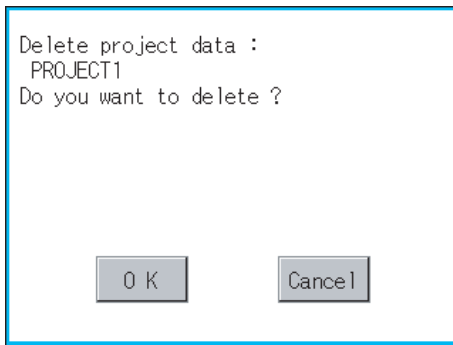

1. Touch and select the file to delete.
2. Touching [Delete] button displays the dialog mentioned left.
Touching [OK] button deletes the file.
Touching [Cancel] button cancels the deletion.
3. When the deletion is completed, the completion dialog is displayed.
Touching [OK] button closes the dialog.

- (4) Copy operation
Copies the selected file.

Dialog for selecting a copy destination drive

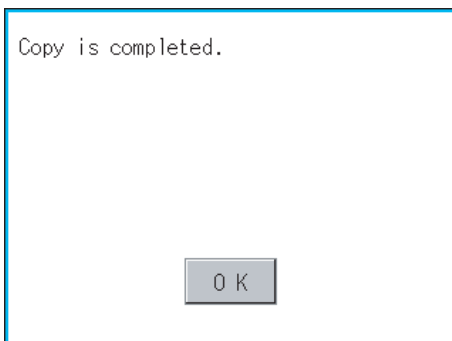
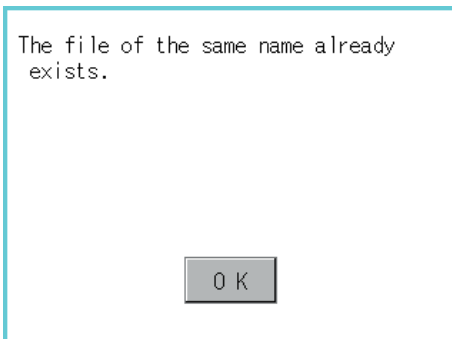
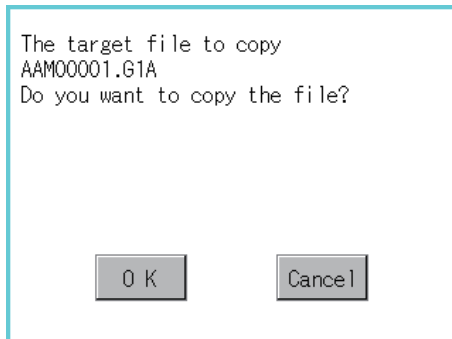
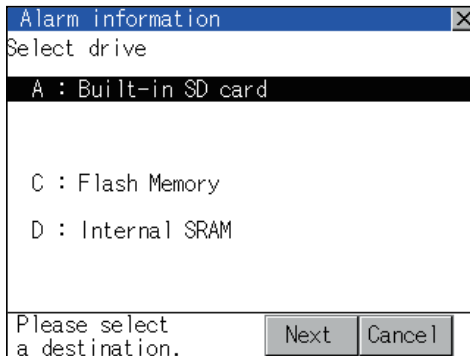

1. Touch and select the file to copy.
2. Touching [Copy] button displays the message [Please select a destination.] in the left bottom of the screen.
3. If the copy destination folder is touched, the screen display is changed to the folder of copy destination. At this time, it cannot be copied into the same folder where the file exists. Select other folders.
4. Touching [Exec.] button displays the dialog box shown left.
5. Touch [OK] button. If there is a file of the same name in the copy destination folder, the following dialog is displayed without starting the copy.
6. When the copy is completed, the dialog of completion is displayed. Touching [OK] button closes the dialog.

13.2.3 Project Information

■ Function of project information

The project data files stored in each drive (A: Built-in SD card, C: Flash Memory, E: USB memory) can be displayed by lists.

In addition, the files can be downloaded, uploaded, deleted or copied, etc.

Function	Description	Reference
Displaying file, folder data	The file/folder type, name, data size and creating date & time are displayed.	13-18, 13-19
Delete	Deletes project data.	13-19
Copy	Copies project data. (can copy the A drive and E drive)	13-20
Property display	Displays the project data creation date, author name and the version of GT Designer3.	13-21
Data check	Data check of files is possible.	13-22
Download	Downloads the project data written in the A drive (Built-in SD card)/E drive (USB drive) to C drive (Flash Memory).	13-22
Setup	The project data to be displayed can be selected.	13-24
Upload	Uploads the project data written in the C drive (Flash Memory) to the A drive (Built-in SD card)/E drive (USB drive).	13-25
Setup cancel	Cancels the item which is selected for the project data to be displayed.	13-26

POINT

Notes on operating project data

When the OS boot drive is set to [A: Built-in SD card], deleting, copying, downloading, setting up, and uploading project data are not available.

■ Display operation of Project information

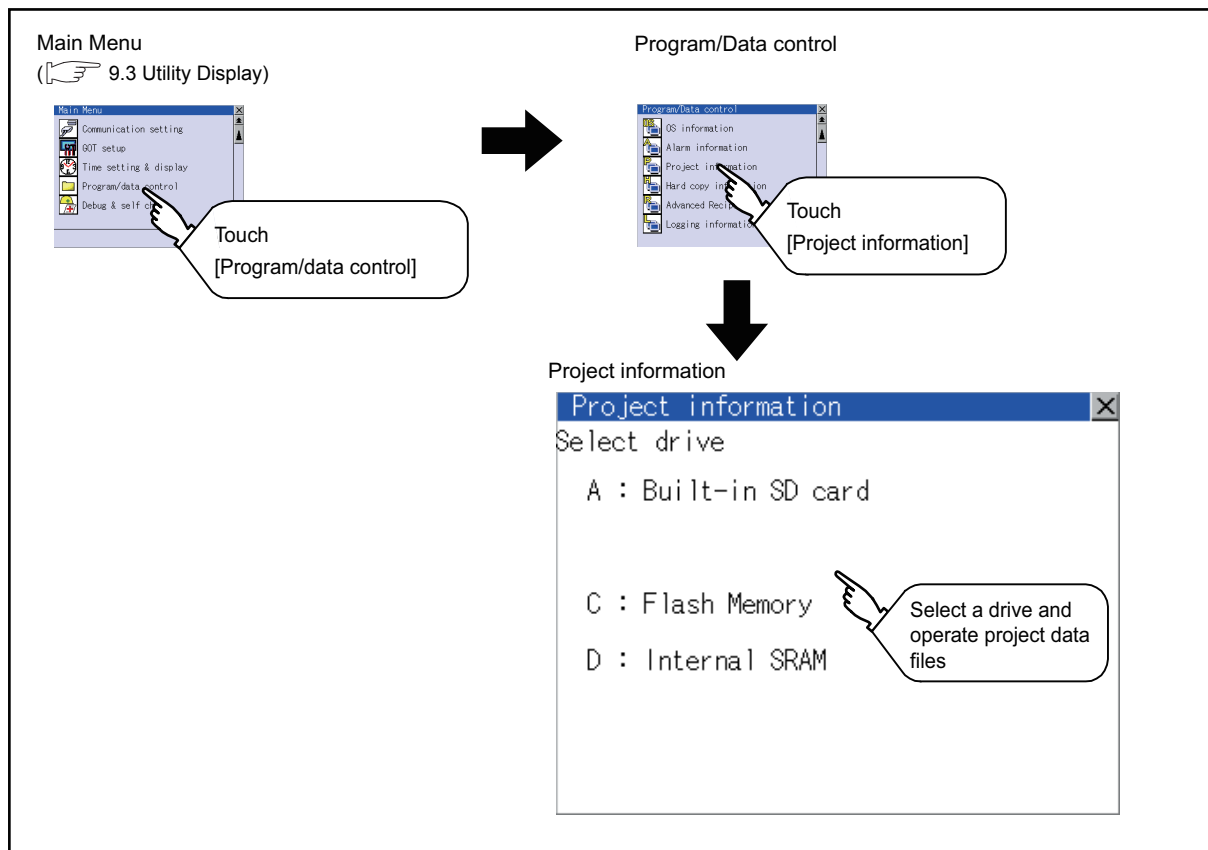

■ Display example of Project information

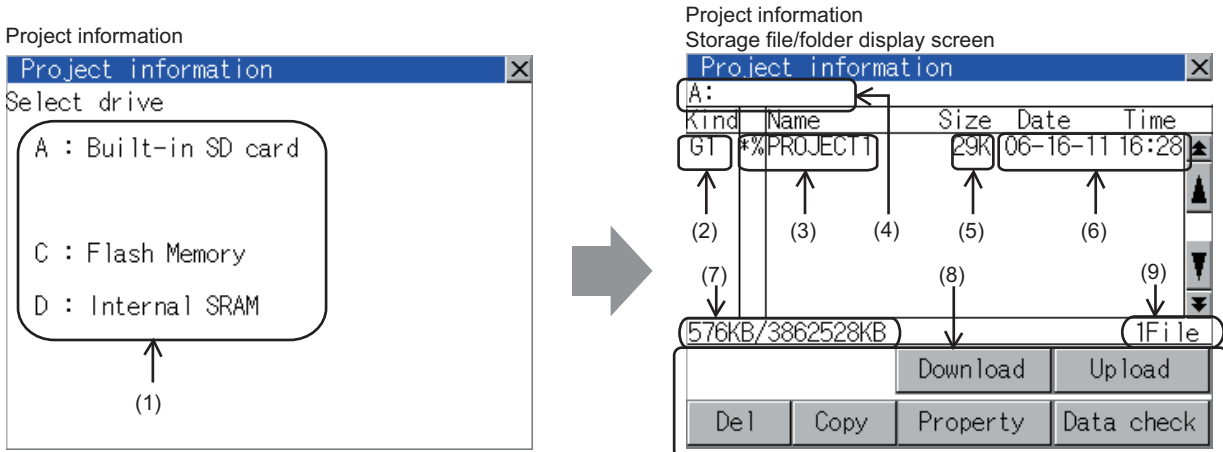

Number	Item	Description
(1)	Select drive	The drive by which a file or folder is displayed can be selected. When the SD card is not installed, [A:Built-in SD card] is not displayed. If the USB memory is not installed, [E: USB drive] is not displayed.
(2)	Kind	Indicates the type of the displayed name (file or folder). The file is indicated with an extension, while the folder is indicated with "DIR."
(3)	Name	Displays the project data (Project Folder) in the selected drive. When the name exceeds 18 characters, the 19th and later characters are not displayed. The project data being monitored on the GOT is preceded by "%".
(4)	Path name	Displays the path name of drive/folder which is currently displayed.
(5)	Size	Displays the size of the file displayed in [Name].
(6)	Date and time	Displays the date and time when each file is installed.
(7)	The size of drive	Displays the size in use and the entire size of the drive which is selected by drive selection. (Only the size in use is displayed when selecting the C drive.)
(8)	Operation switch	Displays the execution switch of functions (download, upload, etc.) which can be carried out in [Project information].
(9)	Number of files	Displays the total number of the displayed files.

POINT

Folders and files displayed

For the folders and files displayed, refer to the following.

☞ 13.1.4 Display file

■ Operation of project information

(1) Display operation of Project information

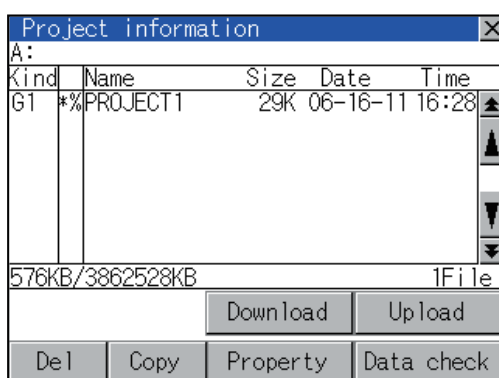

1. Touching a drive in Select drive displays the project data in the drive.
2. Touching project data selects and inverts it.
3. For operation of delete, copy, property, data check, download, upload, refer to the following.

Delete.....		This section (2)
Copy.....		This section (3)
Property.....		This section (4)
Data check.....		This section (5)
Download, setup		This section (6)
Upload, setup cancel		This section (7)

4. Touching [x] button closes the screen.

(2) Deletion operation Deletes selected files.

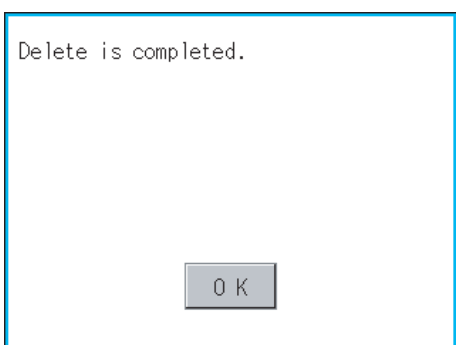
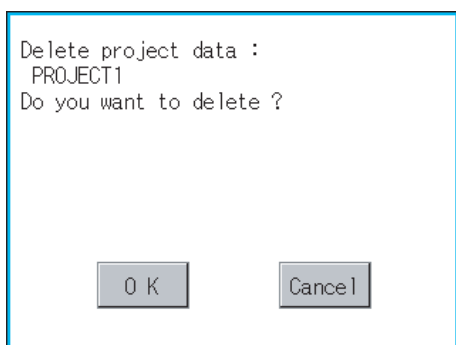

1. Touch and select the file to delete.
2. Touching [Del] button displays the screen mentioned left.
Confirm the deletion targeted file is specified correctly.
Touching [OK] button deletes the file.
Touching [Cancel] button cancels the deletion.
3. When the deletion completes, the dialog box shown left is displayed.
Touching [OK] button closes the dialog.

(3) Copy operation

Uploads the project data written in the C drive (Flash Memory) to the A drive (Built-in SD card)/E drive (USB drive).

- Copying to another directory in the same drive
- Copying between A drive and E drive

Copy to/from C drive or copy to C drive/D drive is disabled.

(This item explains using the A drive.)

Dialog for selecting a copy destination folder

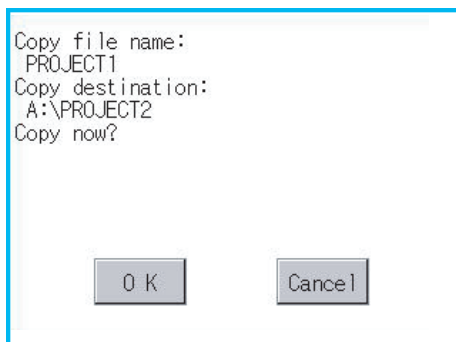
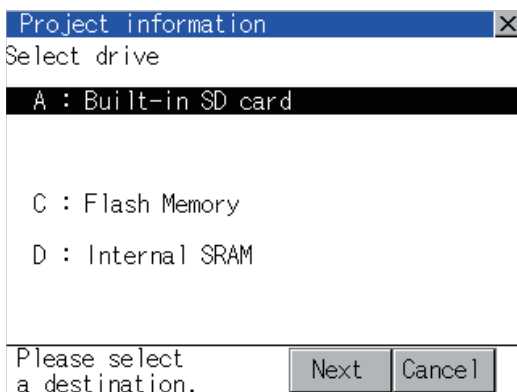

1. Install SD card in the PC, in which create a folder for the copy destination.

Set the same character with [System Setting] of [System Environment] of GT Designer3 for the folder name.

 GT Designer3 Version1 Screen Design Manual (Fundamentals)

2. Install the SD card mentioned above to GOT.

For inserting/removing method of SD card/USB memory, refer to the following.

 8.1.2 Installing and removing procedures of the SD card

8.2.2 Installing and removing procedures of the USB memory

3. Open [Project Information] screen to select the file to copy.

4. Touching [Copy] button displays the message [Please select a destination.] in the left bottom of the screen.

5. If the copy destination folder is touched, the screen display is changed to the folder of copy destination. At this time, it cannot be copied into the same folder where the file exists. Select other folders.

6. Touching [Exec.] button displays the dialog box shown left.

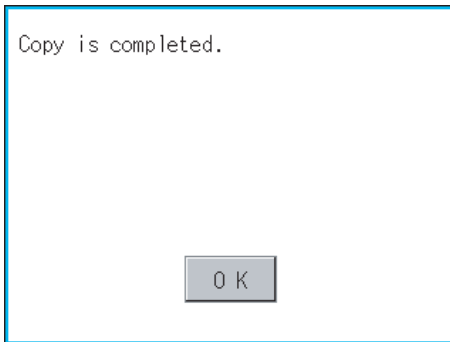
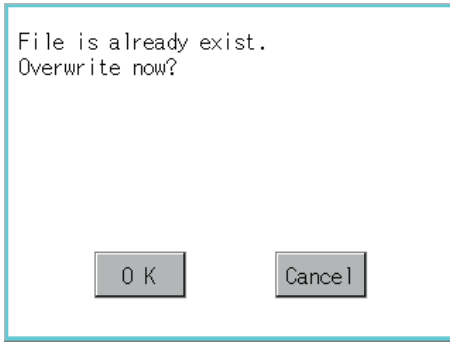

7. Touch [OK] button.
If there is no file of the same name in the copy destination folder, starts to copy.
When there is a file of the same name in the copy destination folder, the dialog mentioned left is displayed without starting the copy.
If copy, in this case, the copied file is overwritten to the project data in the copy destination folder.
Touching [OK] button starts copy.
Touching [Cancel] button cancels the copy.
8. When the copy is completed, the dialog of completion is displayed.
Touching [OK] button closes the dialog.

(4) Property display operation

Displays the property of the project data in the selected folder.

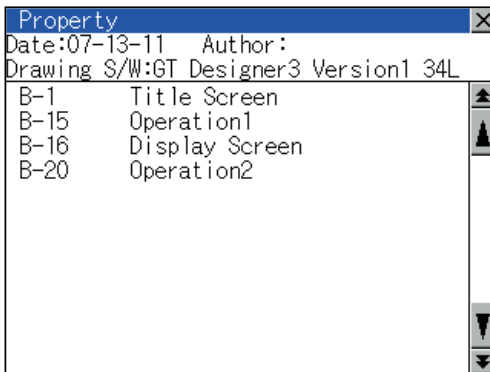

1. Touching [Property] button after selecting the project data to display the property displays the property as shown left.
In property display, the following information is displayed.

Item	Description
Date	Displays the creation date of the file.
Author	Displays the author of the project data.
Drawing S/W version	Displays name and version of the drawing software by which the project data is created.

2. Touching ▲ ▼ button scrolls up/down the screen by one line.
3. Touching ▲ ▼ button scrolls up/down the screen by one screen.
4. Touching [×] button closes the property display and returns to the previous screen.

- (5) Data check operation
Carries out data check of the selected project file.

When data is normal.

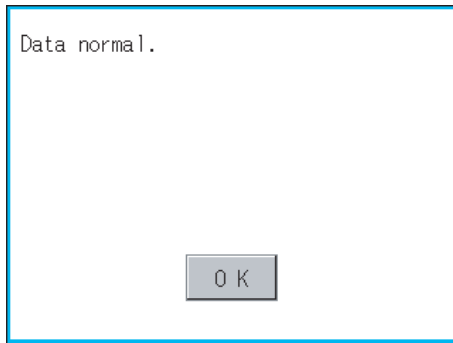

1. Touch [Data check] button after selecting a data check target file. The dialog mentioned left will be displayed after executing data check.
2. Touching [OK] button closes the dialog.

When data is erroneous.



- (6) Download operation/setup operation

- (a) Download operation

Transfers the project data stored in the A drive (Built-in SD Card) or E drive (USB drive) to the C drive (Flash Memory). (The GOT monitors using the data in the C drive.)
(This item explains using the A drive.)

POINT

Before download operation

- (1) Setup cancel

When the project data in the A drive is set up, the project data cannot be downloaded to the C drive. Execute setup cancel (☞ (7) (b) Setup cancel operation) before downloading the project data.

- (2) Project data to be stored in a SD card

When storing the project data from GT Designer3 to SD card, select [C: Built-in flash memory] for [Project Data] in the [Boot Drive].

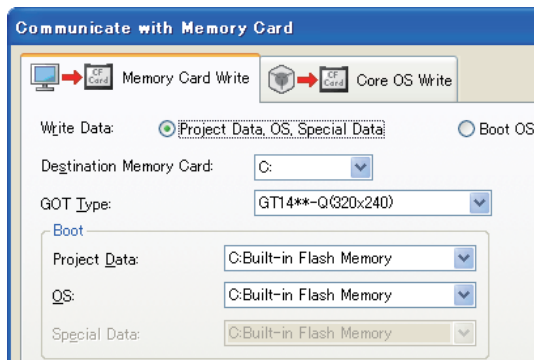

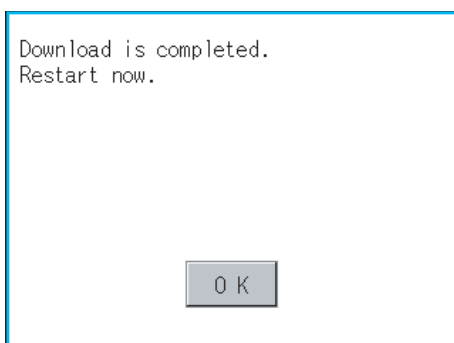
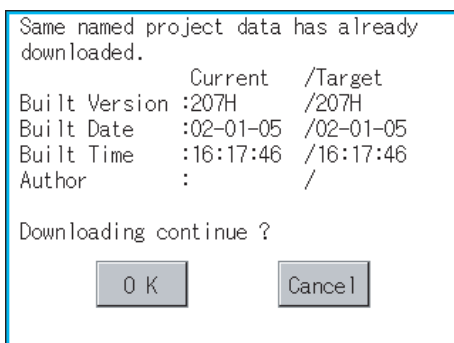
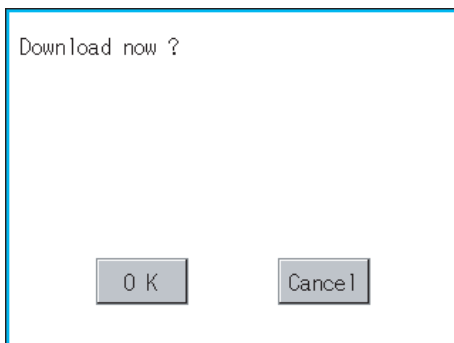
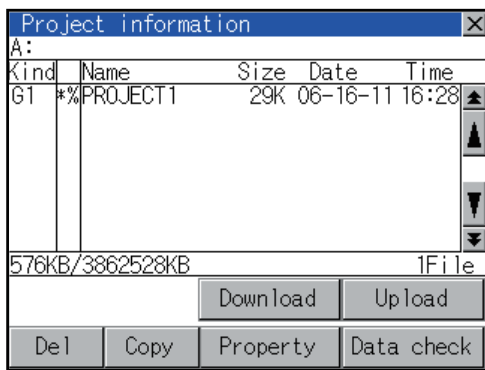

1. Mount the SD card/USB memory to GOT.
2. For the SD card installation/removal method, refer to the following.
 - ☞ 8.1.2 Installing and removing procedures of the SD card
 - 8.2.2 Installing and removing procedures of the USB memory
3. Touch [A: Built-in SD card] of [Select drive].
4. Touching [Download] button displays the screen shown on the left. Touching [OK] button executes the download.
5. If there is a project data of the same name in the C drive, the screen shown on the left is displayed without starting the download. Touching [OK] button executes an overwrite download to the project data of the same name. Touching [Cancel] button cancels the download.
6. When the download is completed, the dialogue box shown on the left is displayed. Touching [OK] button restarts the GOT.

- (b) Setup operation
Sets the project data stored in the A drive (Built-in SD card) to be used in the GOT.
The GOT monitors using the monitor data in the A drive.

POINT

Before setup operation

When storing project data from GT Designer3 to SD card, select [A: Standard SD Card] for [Project Data] in [Boot Drive].

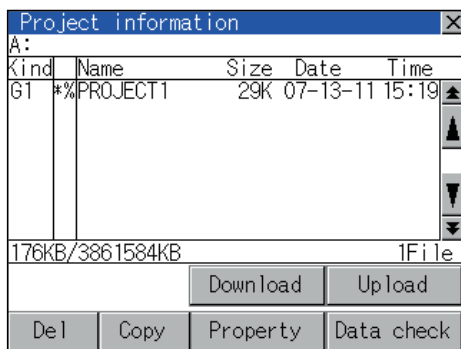
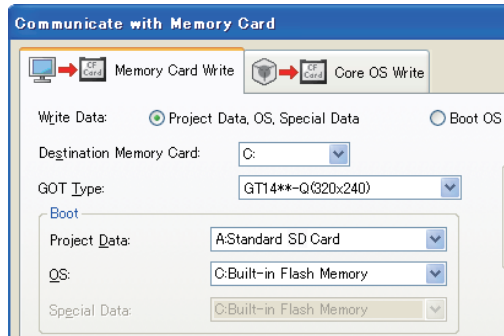

1. Mount the SD card to GOT. For the SD card installation/removal method, refer to the following.
 8.1.2 Installing and removing procedures of the SD card

2. Touch [A: Built-in SD card] of [Select drive].

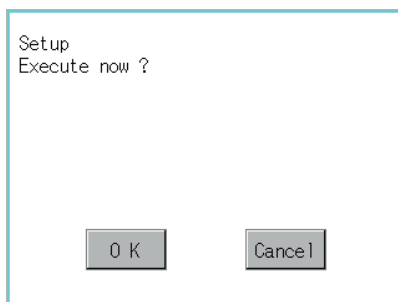

3. Touching [Download] button displays the screen shown on the left.
Touching [OK] button executes the setup.

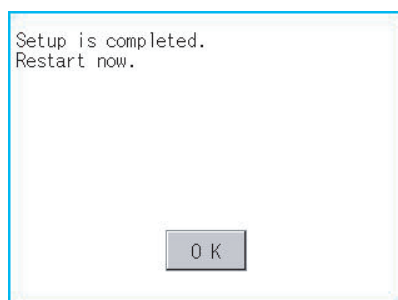

4. When the setup is completed, the dialog box mentioned left is displayed.
Touching [OK] button restarts the GOT.

(7) Upload/setup cancel operation

(a) Upload operation

By upload operation, the project data is transferred from the C drive (Flash Memory) to the A drive (Build-in SD card) or E drive (USB drive).

The SD card or USB memory after uploading can be used for downloading project data to another GOT.
(This item explains using the A drive.)

POINT

Before upload operation

The project data cannot be uploaded to the A drive when the project data of the A drive is set up.

Execute setup cancel (☞ (7)(b) Setup cancel operation) before uploading the project data.

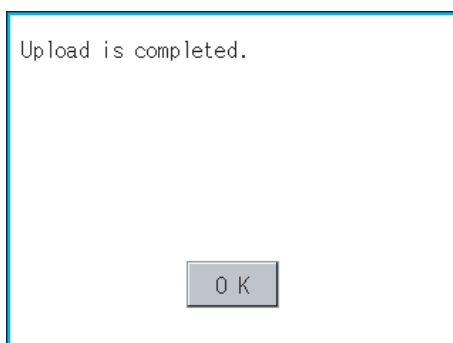
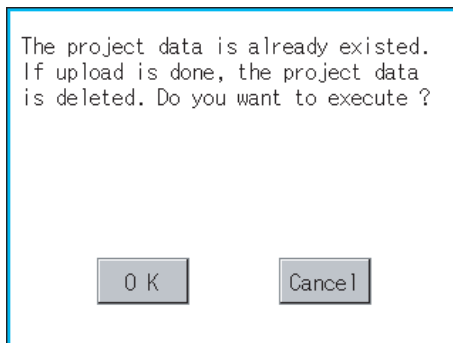
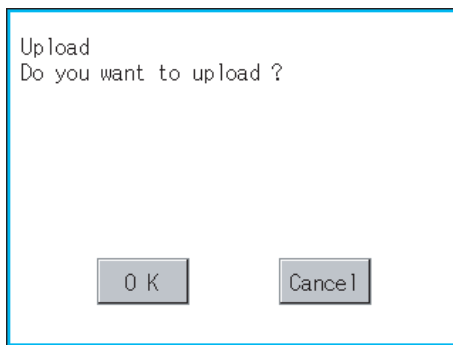

1. Touch [A: Built-in SD card] of [Select drive].
2. Touching [Upload] button displays the screen shown on the left.
3. Touching [OK] button executes the upload.
4. If there is a project data of the same name in the A drive, the screen shown on the left is displayed without starting the upload. Touching [OK] button executes an overwrite upload to the project data of the same name. Touching [Cancel] button cancels the upload.
5. When the uploading is completed, the dialog box mentioned left is displayed. Touching [OK] button restarts the GOT.

- (b) Setup cancel operation
By setup cancel, setup is canceled.

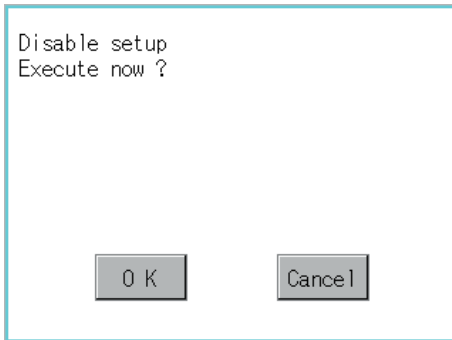

1. Touch [A: Built-in SD card] of [Select drive].
2. Touching [Upload] button displays the screen shown on the left.
3. Touching [OK] button executes the setup cancel.

4. When the setup cancel is completed, the dialog box mentioned left is displayed. Touching [OK] button restarts the GOT. After restart, the GOT monitors with the project data in the C drive.

13.2.4 Hard copy information

■ Function of hardcopy information

Carries out delete, copy and move to the file created by the hardcopy function.
For details of hard copy function, refer to the following manual.

 GT Designer3 Version1 Screen Design Manual (Functions)

Function	Description	Reference
Displaying file, folder data	The file/folder type, name, data size and creating date & time are displayed.	13-28, 13-29
Delete	File is deleted.	13-30
Copy	File is copied.	13-31
Rename	Renames file.	13-32

■ Display operation of Hardcopy information

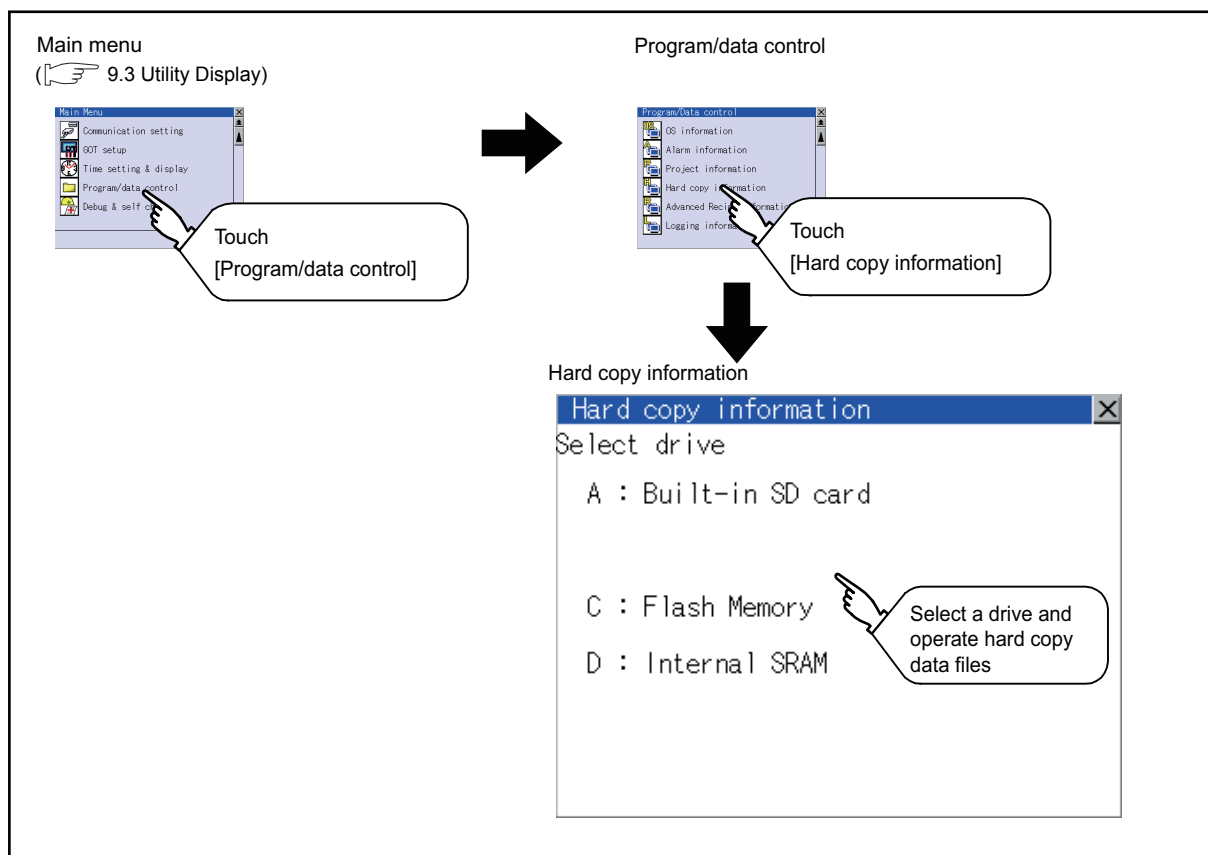

■ Display example of Hardcopy information

Hard copy information

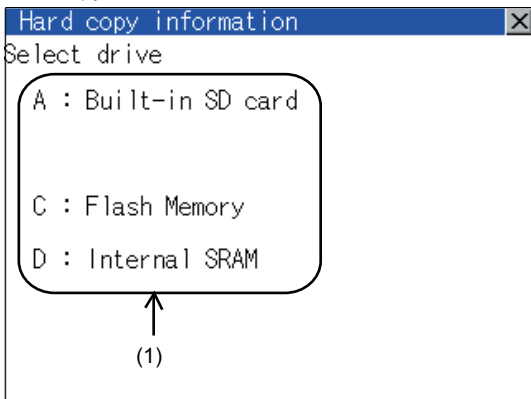

Hard copy information
Storage file/folder display screen

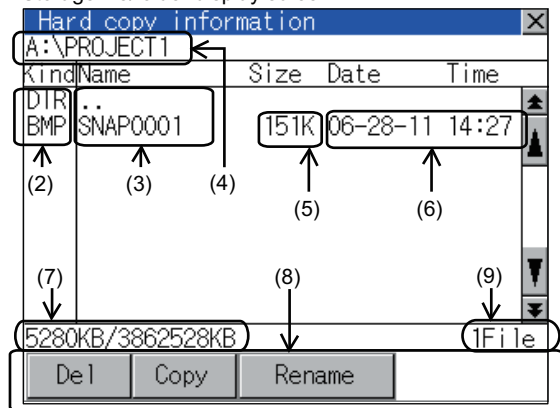

Number	Item	Description
(1)	Select drive	The target drive which displays file or folder can be selected. When SD card or USB memory is not installed, the following drives are not displayed. • SD card: [A: Built-in SD card] • USB memory: [E: USB drive]
(2)	Kind	Indicates the type of the displayed name (file or folder). In case of file, displays the extension; in case of folder, displays "DIR".
(3)	Name	Displays the file name or folder name. For the long file/folder name, entire part may not be displayed. Confirm the nondisplayed part with the [Copy] button, etc. (☞ 13.2.4 ■ Hardcopy information operation (3) Copy operation) After confirmation, touch the [Cancel] button to cancel the operation.
(4)	Path name	Displays the path name of drive/folder which is currently displayed.
(5)	Size	Displays the size of the file displayed in [Name].
(6)	Date and time	The date and time when each file was created are displayed.
(7)	The size of drive	Displays the size in use and the entire size of the drive which is selected by drive selection. (Only the size in use is displayed when selecting the C drive.)
(8)	Operation switch	Execution switch of each function.
(9)	Number of files	Displays the total number of the displayed files.

POINT

- (1) Display of creation date and time
The creation date and time display is not updated even if a file is created or updated while displaying the hardcopy information. To display the updated creation date and time, close the screen currently displayed (by moving to the upper hierarchy folder, etc.) and display the screen again.
- (2) Folders and files displayed
For the folders and files displayed, refer to the following.

☞ 13.1.4 Display file

■ Hardcopy information operation

(1) Display operation of Hardcopy information

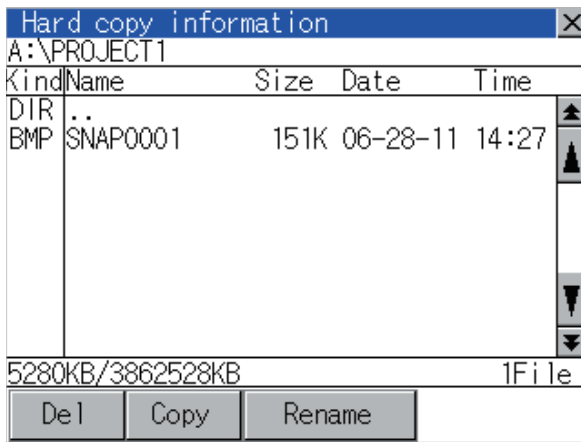

1. Touching a drive of [Select drive] displays the information of the touched drive.
2. Touching a folder name displays the information of the touched folder.
3. Touching a folder of [. .] displays the information of the folder of the one upper hierarchy.
4. Touching ▲ ▼ button of the scrollbar scrolls up/down the screen by one line.
Touching ▲ ▼ button scrolls up/down the screen by one screen.
5. Touching a file name selects the file.
6. For the operations of the delete, copy, and rename, refer to the following.
 - Delete.....☞ This section (2)
 - Copy.....☞ This section (3)
 - Rename.....☞ This section (4)
7. Touching [×] button closes the screen.

- (2) Deletion operation
Deletes selected files.

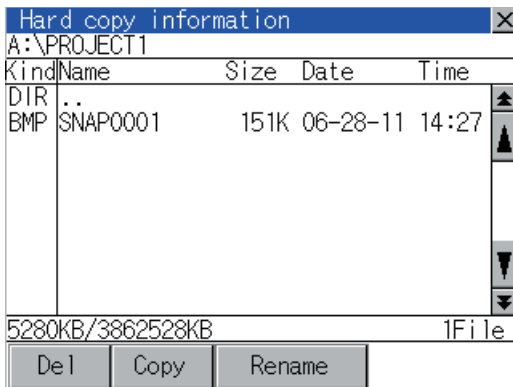

1. Touch and select the file to delete.

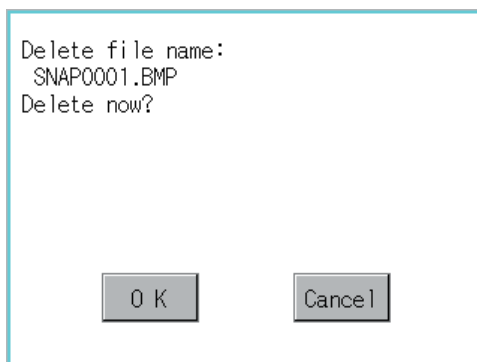

2. Touching [Del] button displays the screen mentioned left.
Touching [OK] button deletes the file.
Touching [Cancel] button cancels the deletion.

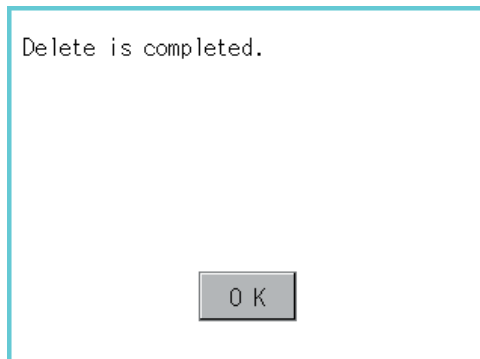

3. When the deletion is completed, the completion dialog is displayed.
4. Touching [OK] button closes the dialog.

- (3) Copy operation
Copies the selected file.

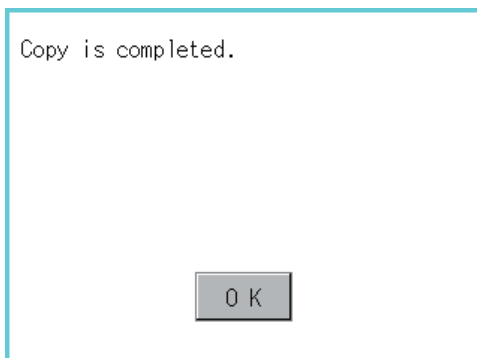
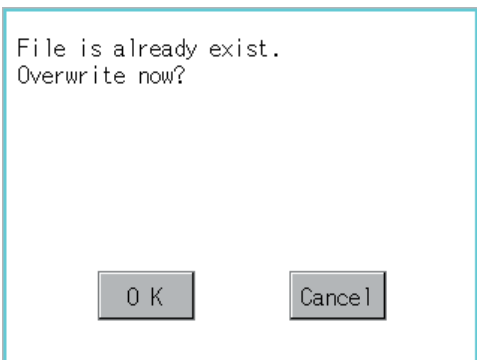
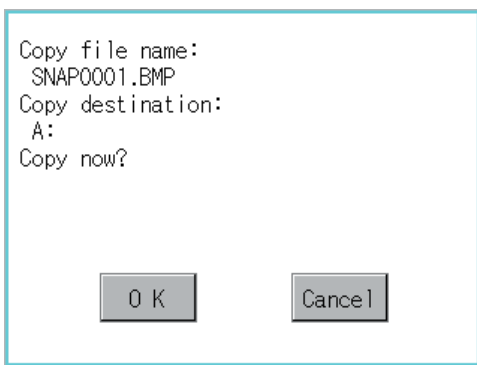
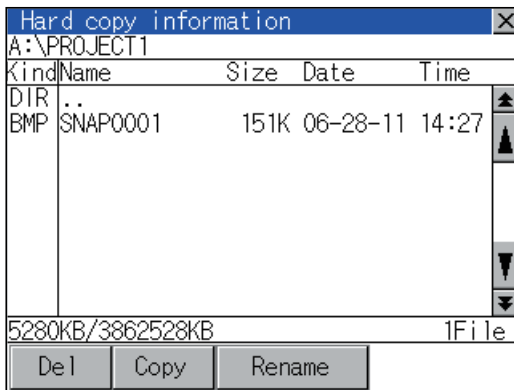

1. Touch and select the file to copy.
2. Touching [Copy] button displays the message [Please select a destination.] in the left bottom of the screen.
3. If the copy destination folder is touched, the screen display is changed to the folder of copy destination. At this time, it cannot be copied into the same folder where the file exists. Select other folders.
4. Touching [Exec.] button displays the dialog box shown left.
5. Touch [OK] button. If there is a file of the same name in the copy destination folder, the following dialog is displayed without starting the copy.
6. Touching [OK] button overwrites the file. Touching [Cancel] button cancels the copy.
7. When the copy is completed, the dialog of completion is displayed. Touching [OK] button closes the dialog.

- (4) Rename operation
Renames the selected file.

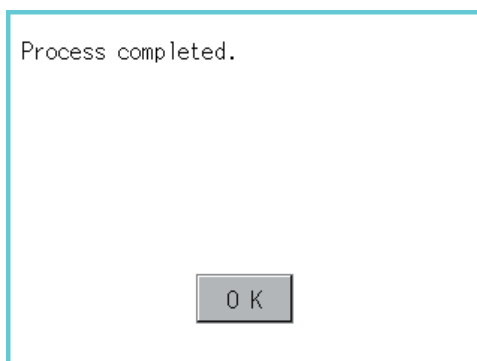
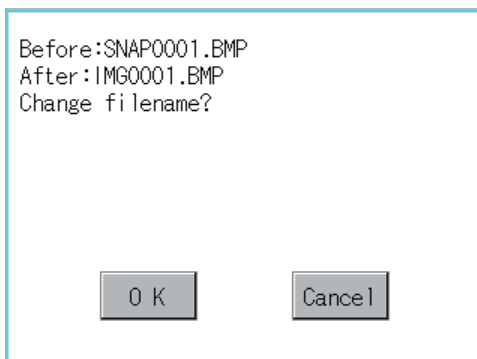
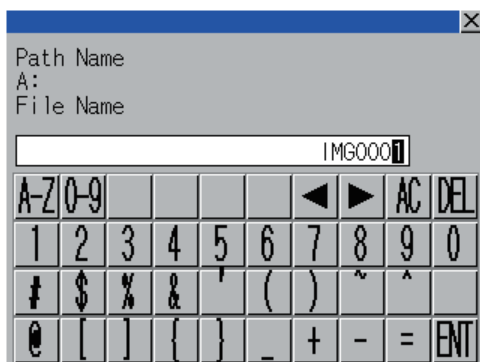
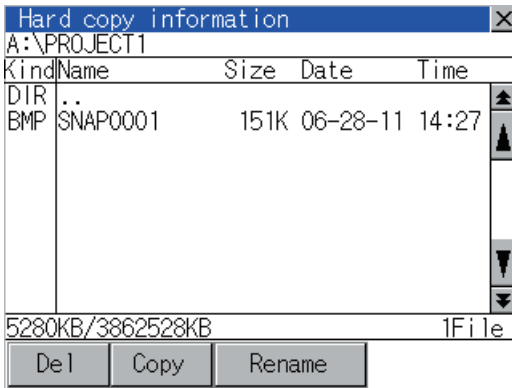

1. Touch and select the file to change the name.

2. Touching [Rename] button displays the screen shown left. Input the file name to be changed. By touching the following button, input text type is changed.

[A-Z]: English capital
[0-9]: Numeric/Symbol

3. Touching [Enter] button displays the dialog box shown left.

4. Touching [OK] button starts renaming file.

5. When renaming is completed, completion dialog box is displayed. Touching [OK] button closes the dialog.

13.2.5 Advanced recipe information

POINT

Before using advanced recipe information

For writing/reading into/from a controller with this function or editing of advanced recipe file on the personal computer, refer to the following manual.

Specifications and operating procedure are described.

 GT Designer3 Version1 Screen Design Manual (Functions)

■ Function of advanced recipe information

For the advanced recipe file used in advanced recipe function, copy/delete/file output are available.

In addition, it is possible to writing/reading into/from a controller by using this function, without creating the screen to operate the advanced recipe. (Advanced recipe setting of GT Designer3 is required.)

Function	Description	Reference	
Advanced recipe information screen	Displaying file, folder data	The file/folder name, data size and creating date & time are displayed.	13-35, 13-37
	G1P → CSV conversion	G1P file of advanced recipe file is converted to CSV file.	13-38
	G1P → TXT conversion	G1P file of advanced recipe file is converted to Unicode text file.	13-38
	CSV/TXT → G1P conversion	CSV file or Unicode text file is converted to G1P file of advanced recipe file.	13-39
	Del	File or folder is deleted.	13-40
	Copy	File is copied.	13-41
	Move	File is moved.	13-42
	Rename	File name is changed.	13-43
	Create Folder	New folder is created.	13-44
Create G1P	New G1P file of advanced recipe file is created.	13-45	
Advanced recipe record list screen	Load record GOT → PLC	Selected record value is loaded in the device of controller.	13-47
	Save record PLC → GOT	The device of controller is saved in selected record.	13-48
	Match records GOT → PLC	Selected record is verified to the device value of controller.	13-49
	Delete Device Value	The device value contained in selected record is deleted.	13-50

■ Display operation of Advanced Recipe information

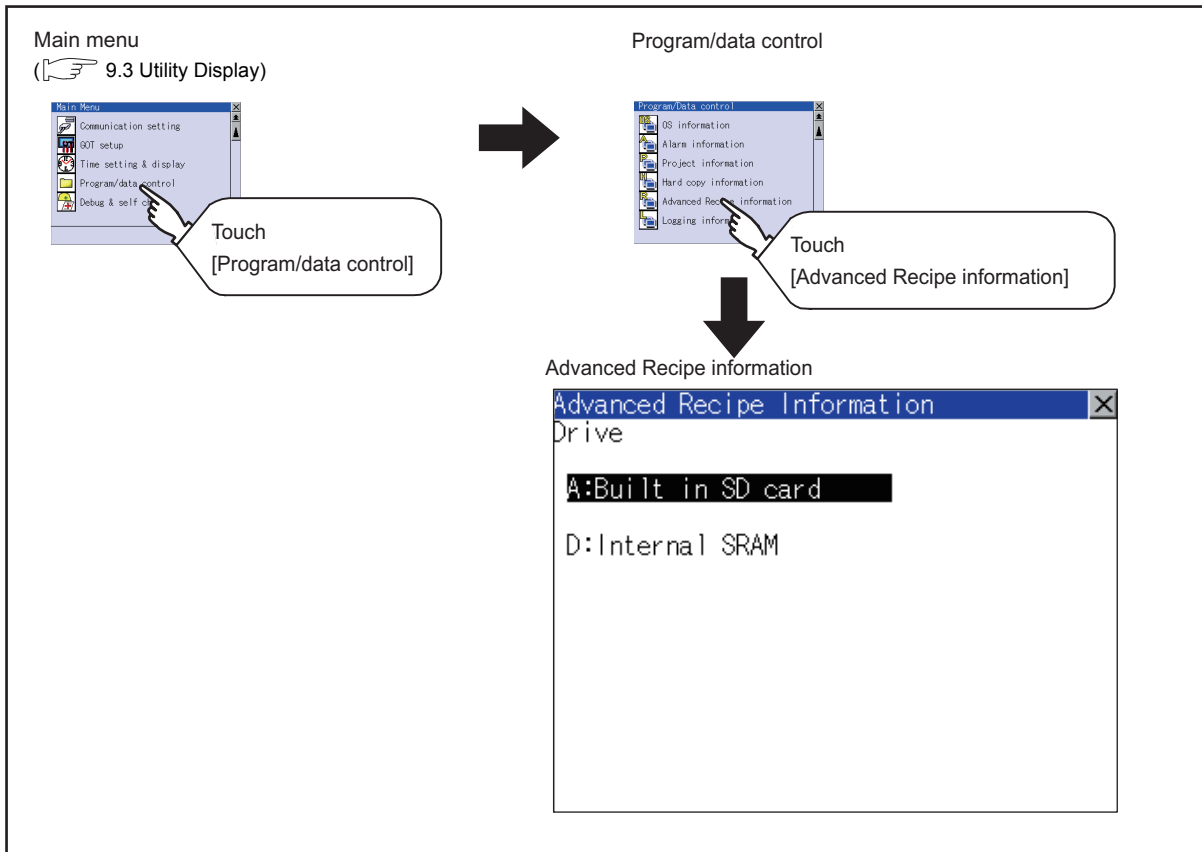

■ Display example of Advanced Recipe information

(1) Advanced recipe information screen

Advanced Recipe Information screen

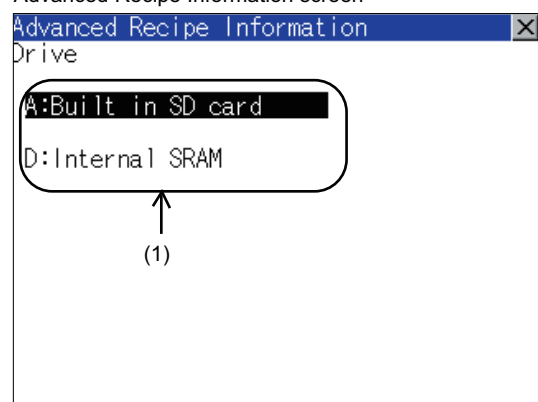

Advanced Recipe Information
Storage file/folder display screen

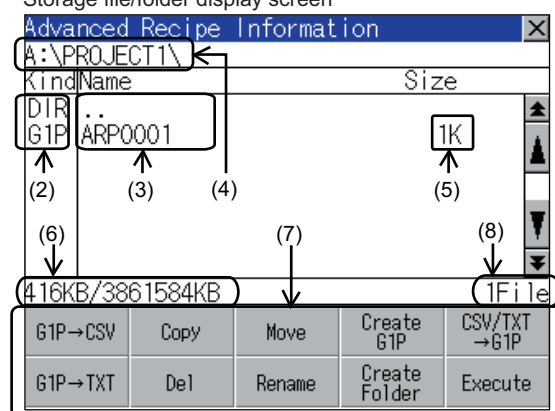

Number	Item	Description
(1)	Select drive	The target drive can be selected. (Even if SD card is not installed, this message appears.)
(2)	Kind	Indicates the type of the displayed name (file or folder). In case of file, displays the extension; in case of folder, displays "DIR".
(3)	Name	Displays the file name or folder name. For the long file/folder name, entire part may not be displayed. Confirm the nondisplayed part with the [Rename] button, etc. (☞ 13.2.5 ■Advanced recipe information operation(7) Rename operation) After confirmation, touch the [Cancel] button to cancel the operation.
(4)	Path name	Displays the path name of drive/folder which is currently displayed.
(5)	Size	Displays the size of the file displayed in [Name].
(6)	The size of drive	Displays the size in use and the entire size of the drive which is selected by drive selection.
(7)	Operation switch	Execution switch of each function.
(8)	Number of files	Displays the total number of the displayed files.

POINT

- (1) About the displayed file
The files other than that for advanced recipe are not displayed on the advanced recipe information screen.
- (2) Folders and files displayed
For the folders and files displayed, refer to the following.

☞ 13.1.4 Display file

(2) Advanced recipe record list screen

Touching the [Execute] button on the advanced recipe information screen after selecting the advanced recipe file, this screen appears.

Records selected in each advanced recipe file can be displayed or saved/loaded.



Number	Item	Description
(1)	No.	Record No. of advanced recipe file is displayed.
(2)	Attr	Attribution of record is displayed. Attribution of record can be changed with GT Designer3. V: Record can be loaded/saved(Record whose value is selected.) VP: Record only for loading(Record whose value is selected and cannot be changed.) Blank: Record only for saving(Record whose value is deleted or not selected.) P: Record unusable (reserved area)(Record whose value is not selected and cannot be changed.)
(3)	Record Comment	Record Comment is displayed.
(4)	File Name	Path and name of recipe file are displayed.
	Setting No.	Recipe No. is displayed.
	Name	Recipe name is displayed.
(5)	Operation switch	Execution switch of each function.

■ Advanced recipe information operation

(1) Display operation of Advanced Recipe information



1. Touching a drive of [Select drive] displays the information of the touched drive.
2. Touching a folder name displays the information of the touched folder.
3. Touching a folder name of [. .] displays the information of the folder in one upper hierarchy.
4. Touching ▲ ▼ button of the scrollbar scrolls up/down the screen by one line.
Touching ▲ ▼ button scrolls up/down the screen by one screen.
5. Touching a file name selects the file.
6. For operation of operating switches, refer to the following.
 - G1P → CSV, G1P → TXT... This section (2)
 - CSV/TXT → G1P..... This section (3)
 - Delete..... This section (4)
 - Copy..... This section (5)
 - Move..... This section (6)
 - Rename..... This section (7)
 - Create Folder..... This section (8)
 - Create G1P..... This section (9)
 - Execute..... This section (10) to (13)
7. Touching [x] button closes the screen.

(2) G1P → CSV conversion operation, G1P → TXT conversion operation

Advanced recipe file (G1P file) is converted to CSV file or Unicode text file that can be displayed/edited on personal computer.

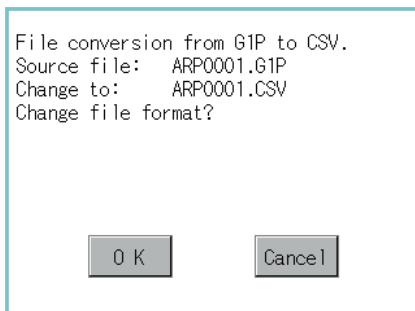
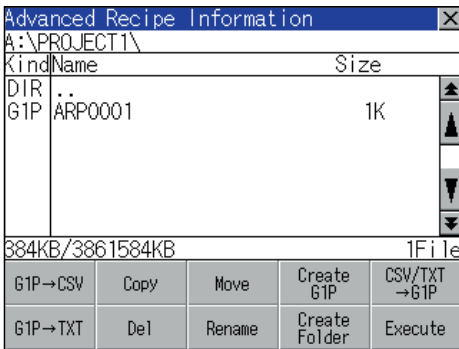

(Example: Dialog box if the [G1P → CSV] button is touched.)

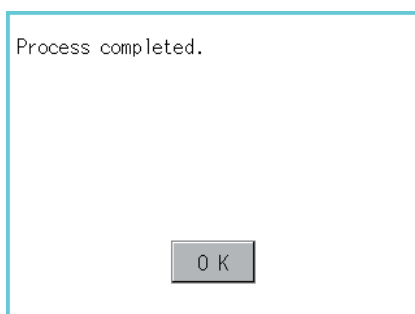
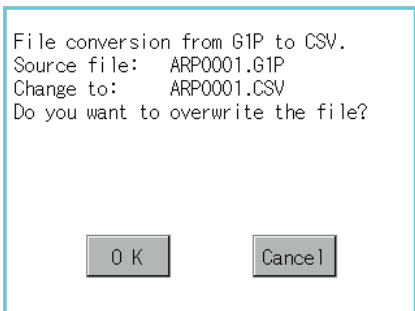

1. Touch and select the G1P file to convert into a CSV file or a Unicode text file.
2. Touch the following button in accordance with destination file type.
 - CSV file: [G1P → CSV] button
 - Unicode text file: [G1P → TXT] button

3. Select the target folder.
(Selecting a folder is not needed for outputting directly below the drive.)

4. Touching [Exec.] button displays the dialog box shown left.
Touch [OK] button.
(While executing, "Processing..." message appears on the screen.)

5. When the file, whose name is the same, exists in the destination folder, the dialog box shown at left appears without starting the conversion.
Touching [OK] button overwrites the file.
Touching [Cancel] button cancels the conversion.

6. The message of completion is displayed in dialog box when conversion is completed.
Touching [OK] button closes the dialog.

(3) CSV/TXT → G1P conversion operation

CSV file or Unicode text file is converted to an advanced recipe file (G1P file).

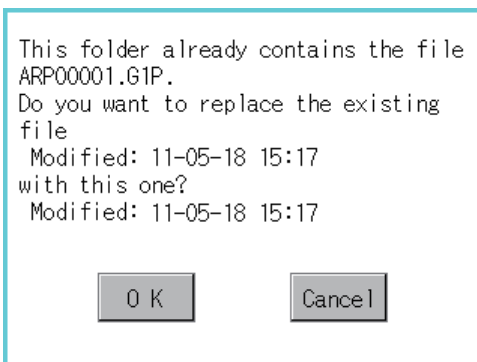
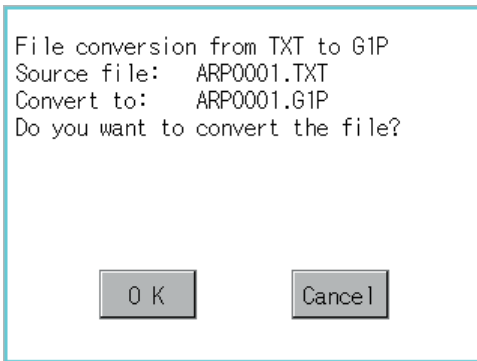
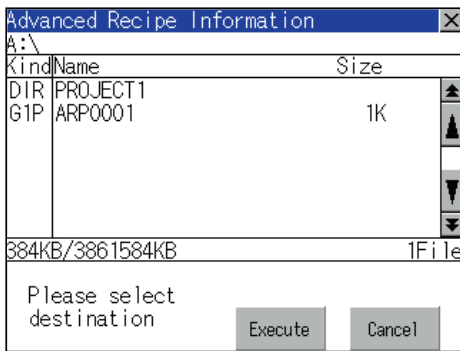

1. To select the file, touch the check box of CSV file or Unicode text file to be converted to a G1P file.

2. Select the target folder.
(Selecting a folder is not needed for outputting directly below the drive.)

3. Touching [Exec.] button displays the dialog box shown left.
Touch [OK] button.
(While executing, "Processing..." message appears on the screen.)

4. When the file, whose name is the same, exists in the destination folder, the dialog box shown at left appears without starting the conversion.
Touching [OK] button overwrites the file.
Touching [Cancel] button cancels the conversion.

5. The message of completion is displayed in dialog box when conversion is completed.
Touching [OK] button closes the dialog.

(4) Deletion operation

Folder and file to be used on advanced recipe are deleted.

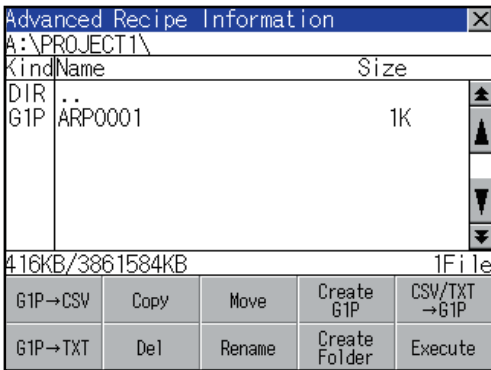

1. Touch and select the file/folder to delete.

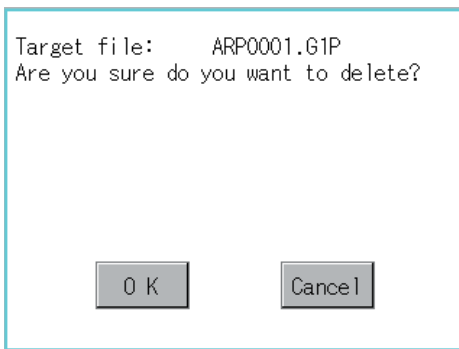

2. Touching [Del] button displays the dialog mentioned left.
Touching [OK] button deletes the file/folder. (While executing, "Processing..." message appears on the screen.)
Touching [Cancel] button cancels the deletion.

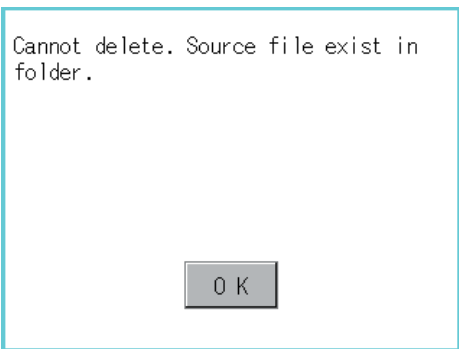

When it cannot be deleted, the dialog box shown at left appears. (Only when deleting folder is executed.)
Verify that there is no file in the folder and execute the delete operation again.
(☞ 13.2.6 ■ Precautions)

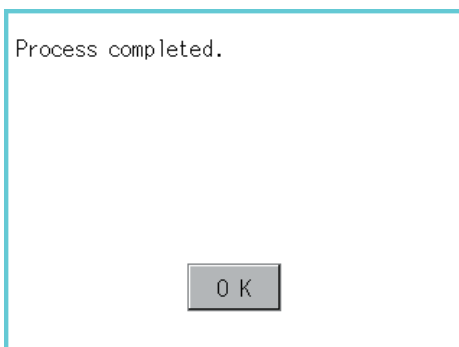

3. When the deletion is completed, the completion dialog is displayed.
Touching [OK] button closes the dialog.

- (5) Copy operation
Folder to be used in advanced recipe is copied.

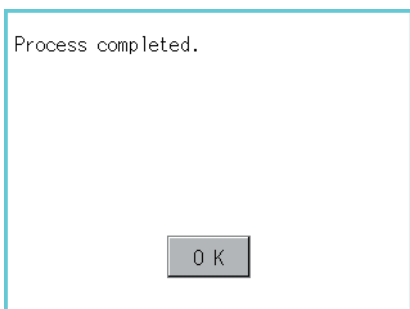
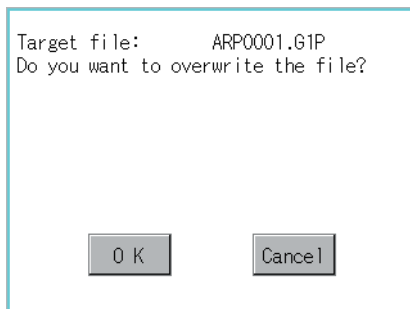
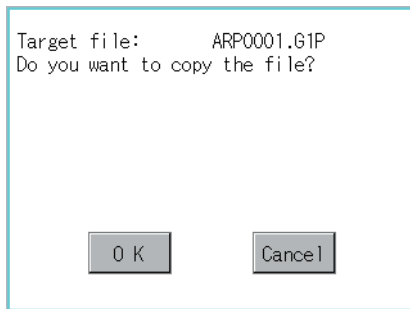
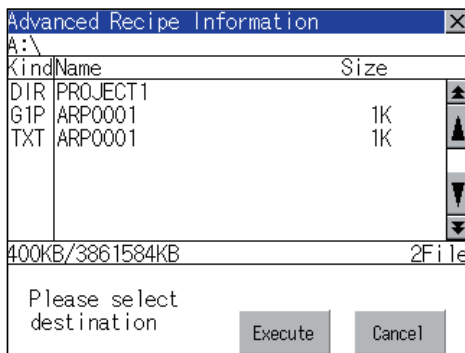
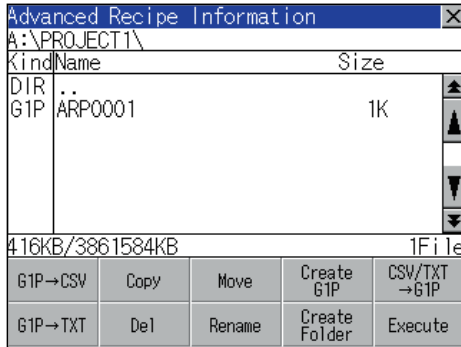

1. Touch and select the file to copy.
2. Touch the [Copy] button.
3. Select the target folder.
(Selecting a folder is not needed for outputting directly below the drive.)
At this time, it cannot be copied into the same folder where the file exists.
Select other folders.
4. Touching [Execute] button displays the dialog box shown left.
Touch [OK] button.
(While executing, "Processing..." message appears on the screen.)
5. If there is a file of the same name in the copy destination folder, the following dialog is displayed without starting the copy.
Touching [OK] button overwrites the file.
Touching [Cancel] button cancels the copy.
6. When the copy is completed, the dialog of completion is displayed.
Touching [OK] button closes the dialog.

(6) Move operation

Files to be used in advanced recipe are moved.

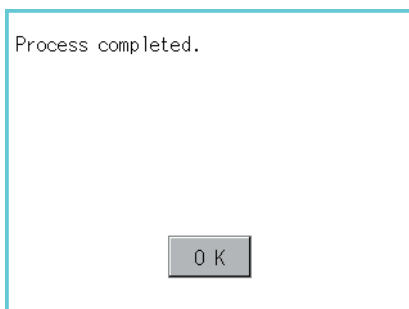
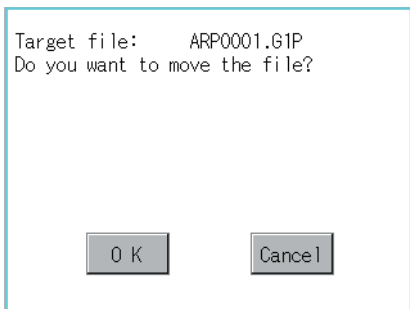
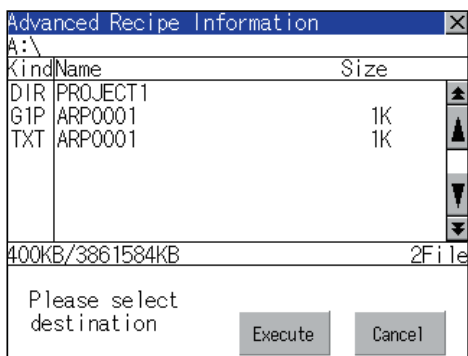

1. Touch and select the file to move.
2. Touch the [Move] button.
3. Select the target folder.
(Selecting a folder is not needed for moving directly below the drive.)
4. Touching [Execute] button displays the dialog box shown left.
Touch [OK] button.
(While executing, "Processing..." message appears on the screen.)
5. When any file with the same name exists in the destination folder, the dialog box shown left appears without starting the movement.
Touching the [OK] button overwrites the file.
Touching [Cancel] button cancels moving.
6. When moving is completed, completion dialog box is displayed.
Touching [OK] button closes the dialog.

(7) Rename operation

File name to be used in advanced recipe is changed.

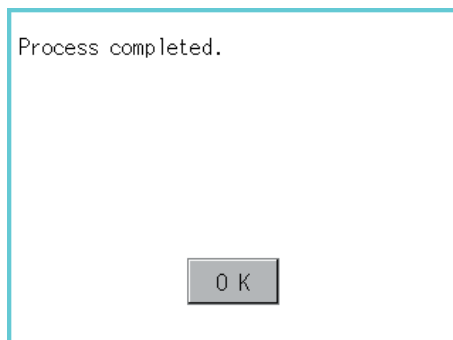
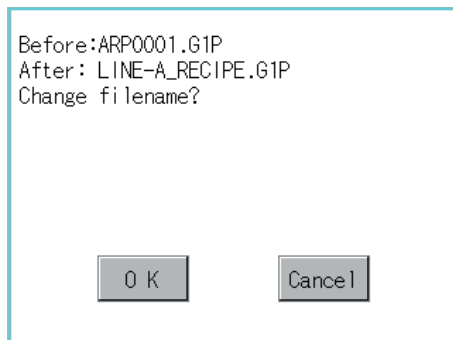
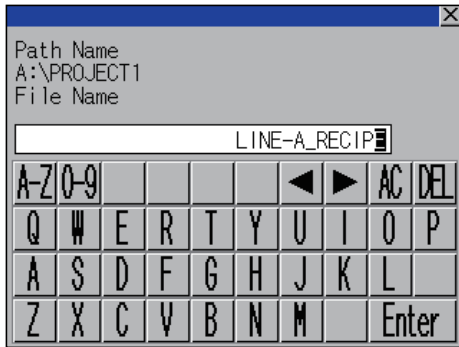

1. Touch and select the file to change the name.

2. Touching [Rename] button displays the screen shown left. Input the file name to be changed. By touching the following button, input text type is changed.

[A-Z]: English capital
[0-9]: Numeric/Symbol

3. Touching [Enter] button displays the dialog box shown left.

4. Touching [OK] button starts renaming file. (While executing, "Processing..."message appears on the screen.)

5. When renaming is completed, completion dialog box is displayed. Touching [OK] button closes the dialog.

- (8) Folder create operation
Folder to be used in advanced recipe is created.

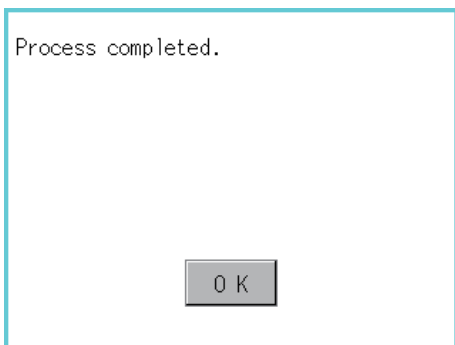
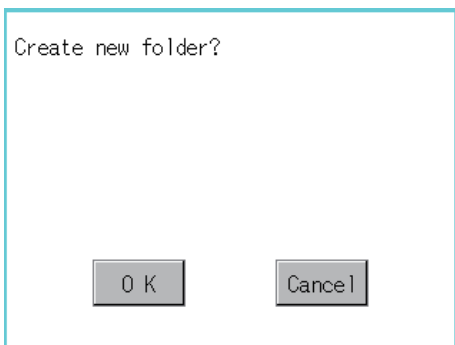
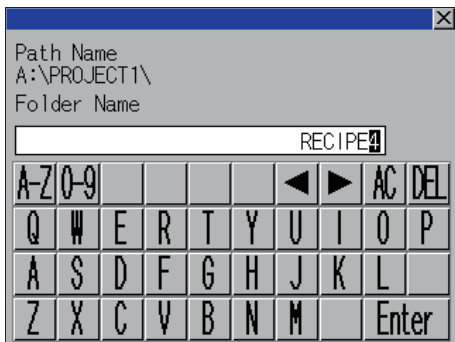
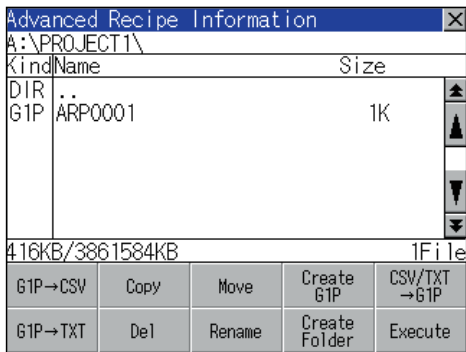

1. Touch the [Create Folder] button.
2. The input key window shown left appears, then input the file name to be created.
By touching the following button, input text type is changed.
[A-Z]: English capital
[0-9]: Numeric/Symbol
3. Touching [Enter] button displays the dialog box shown left.
4. Touching [OK] button starts creating folder.
5. When creating folder is completed, completion dialog box is displayed.
Touching [OK] button closes the dialog.

(9) G1P file create operation

Advanced recipe file (G1P file) is created.

When advanced recipe is only executed on Utility, advanced recipe file should be created with this function in advance.

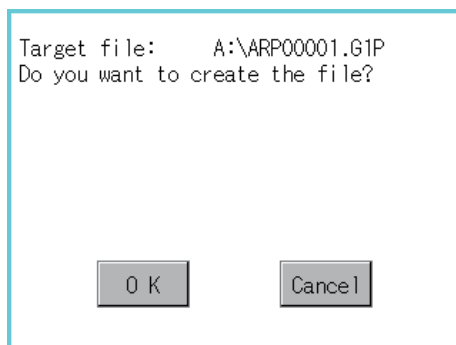
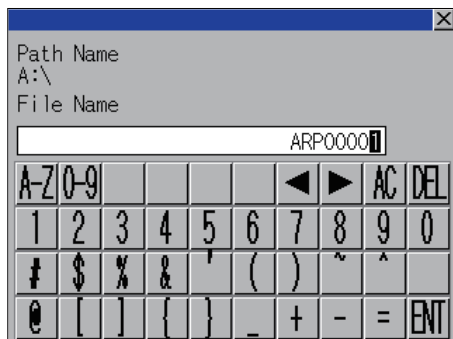
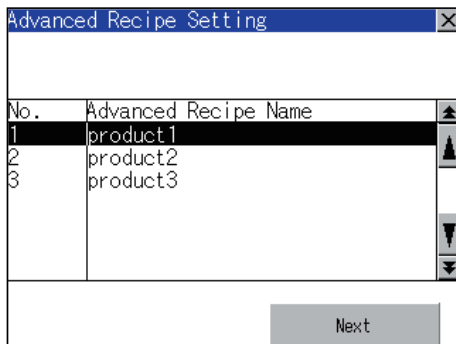

(Continued to next page)

1. Touch the [Create G1P] button.

2. The screen to select the advanced recipe setting is displayed.

Select the advanced recipe setting to be used for new file.

After selecting, touch the [Next] button.

3. As the input key window is displayed, input the file name for new file.

By touching the following button, input text type is changed.

[A-Z]: English capital

[0-9]: Numeric/Symbol

4. Touching [Enter] button displays the dialog box shown left.

Touch [OK] button.

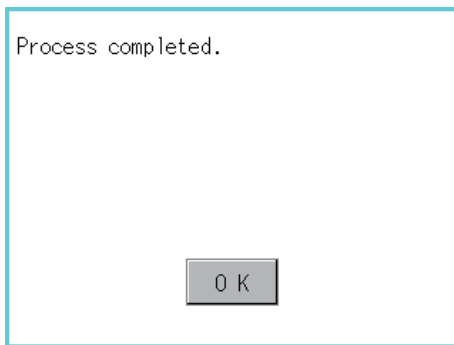
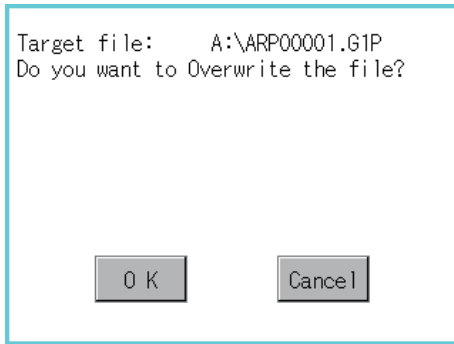

5. When the file, whose name is the same, exists in the destination folder, the dialog box shown left appears without starting the creation. Touching the [OK] button overwrites the file. Touching [Cancel] button cancels creating.

6. When creating is completed, completion dialog box is displayed. Touching [OK] button closes the dialog.

(10) Record load operation

Selected record value is loaded in the device of controller.

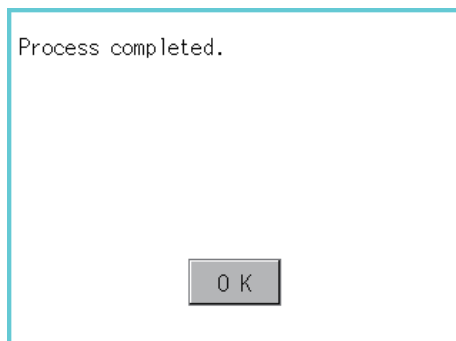
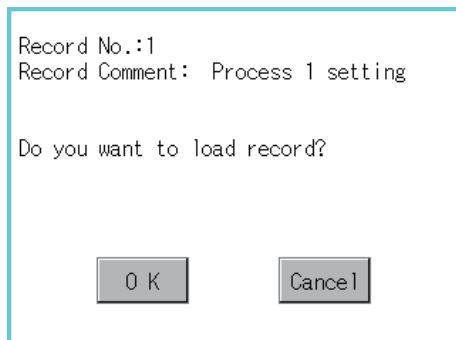
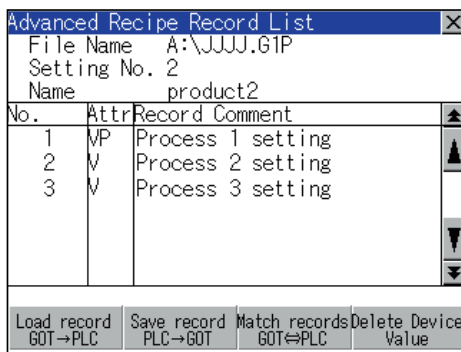

1. Select the recipe file and touch the [Execute] button.

2. As the Advanced Recipe Record List screen is displayed, select the record comment to which you want to load the device value.

3. Touching the [Load record GOT → PLC] button displays the dialog box shown left.

4. Touching the [OK] button starts loading record.

5. When loading is completed, completion dialog box is displayed. Touching [OK] button closes the dialog.

(11) Record save operation

Device value of a controller is saved in the selected record.

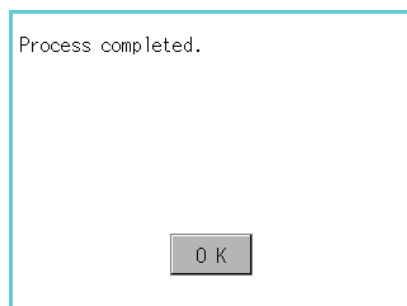
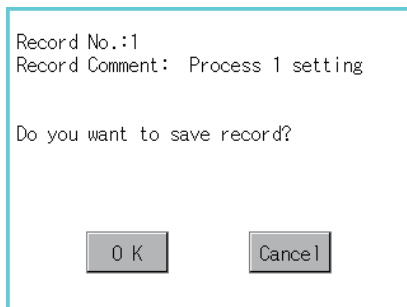
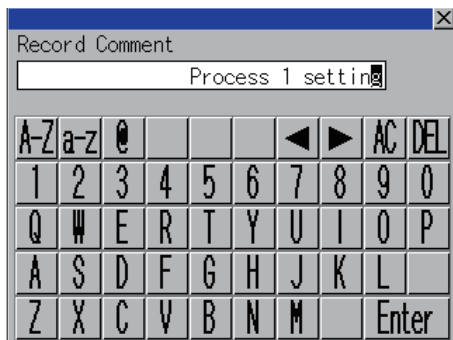
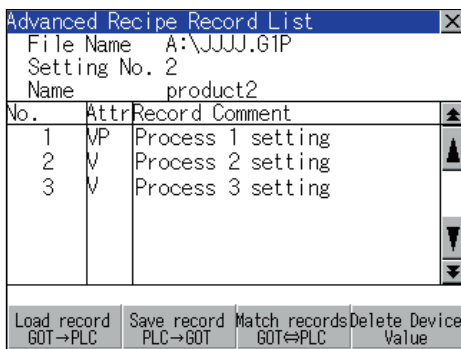
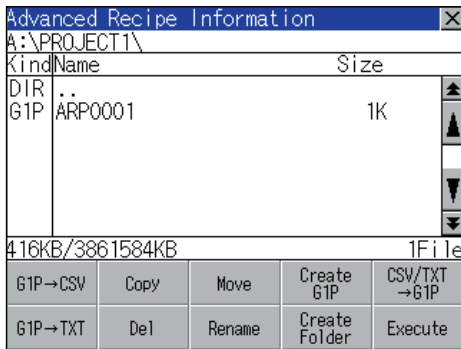

1. Select the recipe file and touch the [Execute] button.

2. As the Advanced Recipe Record List screen is displayed, select the record comment for saving the device value.

3. Touching the [Save record PLC → GOT] button displays the screen shown left. For changing the record comment of saving destination, input the record comment. By touching the following button, input text type is changed.
 [A-Z]: English capital
 [a-z]: English minuscule
 [0-9]: Numeric/Symbol
 Other than alphanumeric and symbol can not be inputted.
 If record comment is not changed, it is not need to input.

4. Touching [Enter] button displays the dialog box shown left.

5. Touching the [OK] button starts saving record.

6. When saving is completed, completion dialog box is displayed. Touching [OK] button closes the dialog.

(12) Record match operation

Verifies whether selected record matches to the device value of the controller.

After executing loading/saving with advanced recipe, verifies whether its contents are reflected.

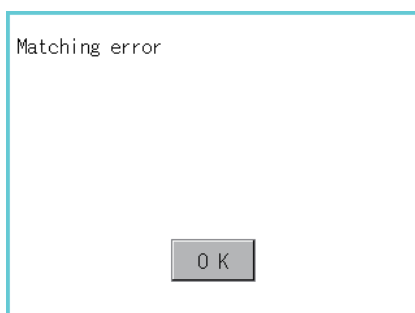
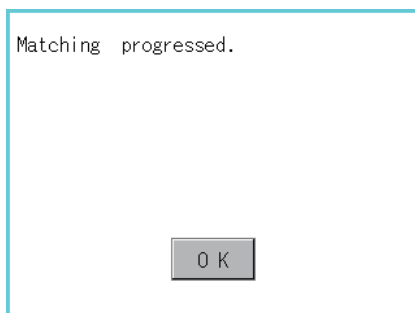
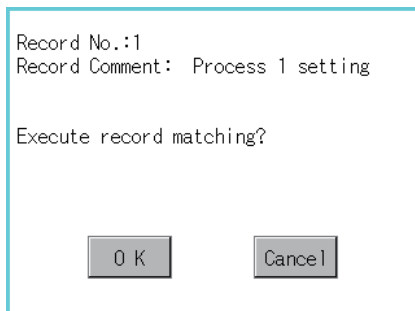
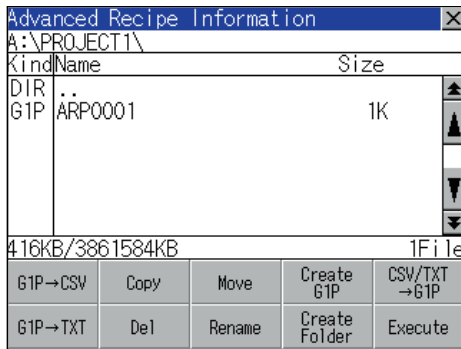

1. Select the recipe file and touch the [Execute] button.
2. As the Advanced Recipe Record List screen is displayed, select the record comment for matching the device value.
3. Touching the [Match records GOT → PLC] button displays the dialog box shown left.
4. Touching the [OK] button starts matching record.
5. When matching is completed, completion dialog box is displayed. Touching [OK] button closes the dialog.
6. If selected record does not match to the device value of controller, the dialog box shown left is displayed.

(13) Device value delete operation

The device value of selected record is deleted (without value) and changed to record only for reading.
(The record name is not deleted.)



1. Select the recipe file and touch the [Execute] button.

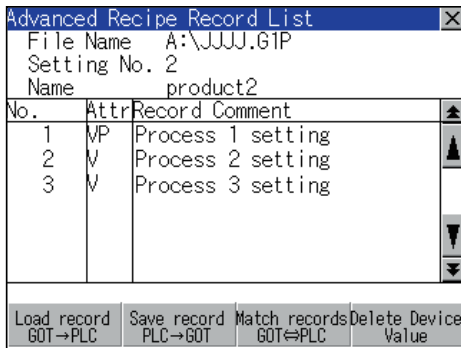

2. As the Advanced Recipe Record List screen is displayed, select the record comment to be deleted.
(If the data of which attribution contains "P" can not be deleted.)

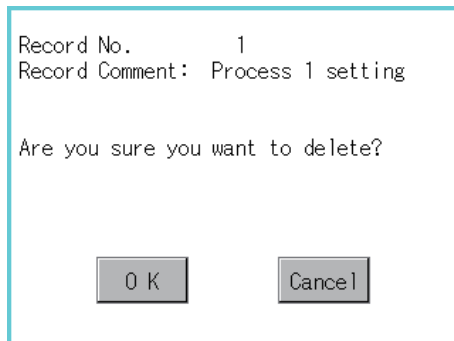

3. Touching the [Delete Device Value] button displays the dialog box shown left.

4. Touching the [OK] button starts deleting device value.
(The "Processing..." message is displayed on the screen.)

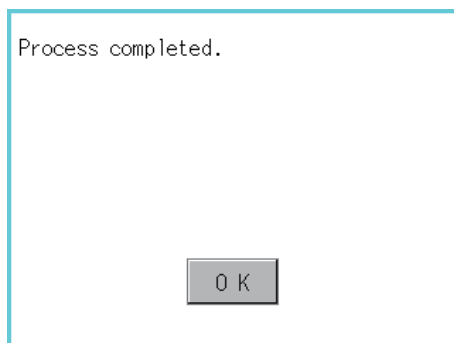

5. When deleting is completed, completion dialog box is displayed.
Touching [OK] button closes the dialog.

■ Precautions

(1) When creating folder/file

- (a) Number of characters set for folder or file name when creating folder/file.
GOT recognizes file location according to path explained below.
Specify folder or file name, and total characters of path cannot exceed 78 characters.
Users only can rename folder or file name.
(Other than folder/file name is automatically printed.)

Example: CSV file Path in SD card or USB memory

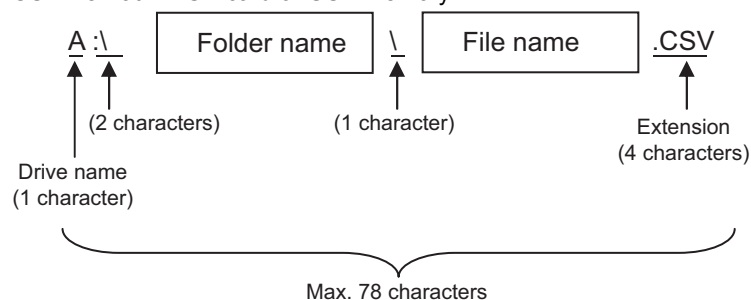

POINT

If folder is assigned the hierarchy.

The \ mark is displayed between folder name and folder name, folder name and file name. The \ mark is also counted as one character.

(b) Character strings that cannot be set to folder/file

The following character strings cannot be used as a folder name or a file name. Even small characters of those cannot be used.

- COM1 to COM9
- LPT1 to LPT9
- AUX
- CON
- NUL
- PRN
- CLOCK\$

In addition, the folder/file name shown below cannot be used.

- The folder name which begins with G1.
- Folder name and file name which begin with . (period).
- Folder name and file name which finish with . (period).
- Folder name and file name which have only . (one period) or ..(two periods).

(c) For deleting the folder

The folder in which the file exists cannot be deleted.

Delete the folder after having deleted the files.

In addition, on the advanced recipe information screen, the file other than that for advanced recipe is not displayed on GOT.

When the folder, in which there is no file displayed on the screen, cannot be deleted, confirm whether there is other file in SD card or USB memory by using personal computer, etc.

(2) Precautions for operation

(a) Precautions during folder/file operation (Create/Delete/Copy/File output, etc)

Even if SD card access switch has been turned OFF while GOT is processing folders and files, the processing continues to be executed. (Example: Even if SD card access switch has been turned OFF while GOT is creating a folder, the folder is created.)

Therefore, do not pull out the SD card while the "Processing..." message is on the screen after SD card access switch has been turned OFF.

(b) While GOT is accessing to other file (Alarm data, etc)

When folder/file processing for the recipe is executed while the GOT is in access to other file (SD card access LED ON), the GOT executes folder/file processing for the Advanced Recipe after the processing for other file has completed.

Therefore, it may take some time to finish the process of advanced recipe folder/file. (The "Processing..." message is displayed on the screen.)

POINT

Estimation of processing time

The process may take time depending on the setting of advanced recipe file to be operated. (The more number of blocks increases, the longer it takes to process advanced recipe folder/file.)

Also, the process to create the first file may take time depending on the setting of advanced recipe file.

(Reference value)

Direct connection to QCPU and CPU(device point:32767 points setting, transmission speed: 115200bps)

- When the block setting number to 1: about 17 seconds
- When the block setting number to 2048: about 4 minutes

(c) For executing the saving/loading of device value with advanced recipe file which has been moved or whose name has been changed.

Adjust [Recipe File] setting of advanced recipe setting with GT Designer3 to file which has been moved or whose name has been changed.

After the setting has been changed, download the advanced recipe setting to GOT.

13.2.6 Logging information

■ Function of logging information

Logging files created with the logging function can be copied, deleted or renamed, etc. Without using a PC, you can manage logging files on the GOT.

For details of the logging function, refer to the following manual.

 GT Designer3 Version1 Screen Design Manual (Functions)

Function	Description	Reference
Displaying file, folder data	The file/folder name, data size and creating date & time are displayed.	13-54, 13-55
G1L → CSV conversion	G1L file of loggingfile is converted to CSV file.	13-56
G1L → TXT conversion	G1L file of loggingfile is converted to Unicode text file.	13-56
Del	File or folder is deleted.	13-57
Copy	File is copied.	13-58
Move	File is moved.	13-59
Rename	File name is changed.	13-60
Create Folder	New folder is created.	13-61

■ Display operation of Logging information

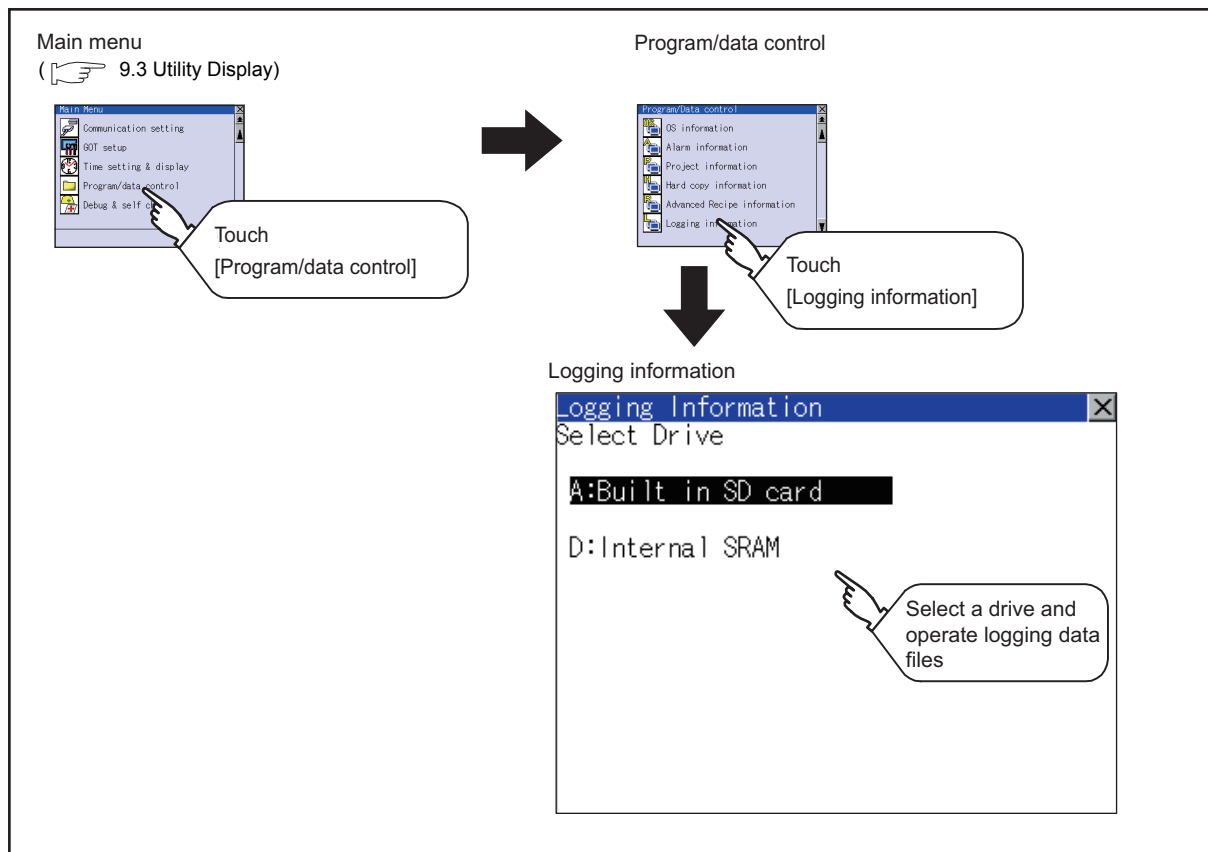

■ Display example of Logging information

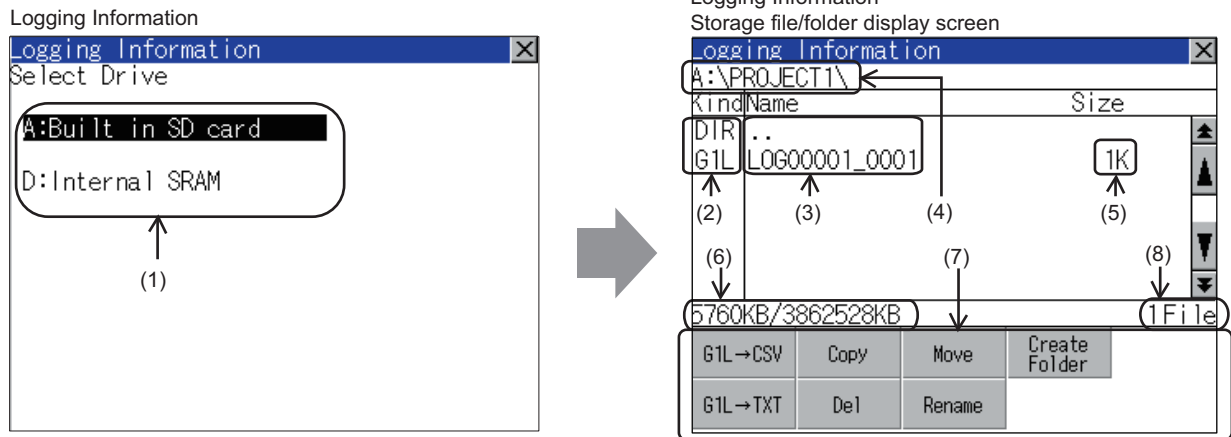

Number	Item	Description
(1)	Select drive	The target drive can be selected. (Even if SD card is not installed, this message appears.)
(2)	Kind	Indicates the type of the displayed name (file or folder). In case of file, displays the extension; in case of folder, displays "DIR".
(3)	Name	Displays the file name or folder name. For the long file/folder name, entire part may not be displayed. Confirm the nondisplayed part with the [Rename] button, etc. (☞ 13.2.6 ■ Logging information operation (6)Rename operation) After confirmation, touch the [Cancel] button to cancel the operation.
(4)	Path name	Displays the path name of drive/folder which is currently displayed.
(5)	Size	Displays the size of the file displayed in [Name].
(6)	The size of drive	Displays the size in use and the entire size of the drive which is selected by drive selection.
(7)	Operation switch	Execution switch of each function.
(8)	Number of files	Displays the total number of the displayed files.

POINT

- (1) About the displayed file
The files other than that for logging are not displayed on the logging information screen.
- (2) Folders and files displayed
For the folders and files displayed, refer to the following.

☞ 13.1.4 Display file

■ Logging information operation

(1) Display operation of logging information

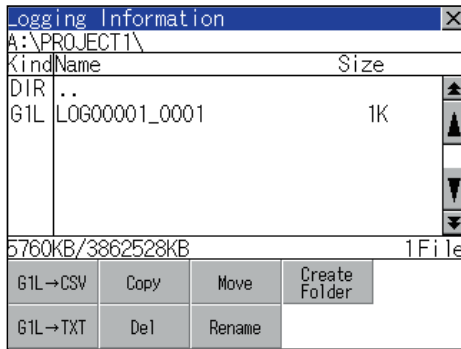

1. Touching a drive of [Select Drive] displays the information of the touched drive.
2. Touching a folder name displays the information of the touched folder.
3. Touching a folder name of [. .] displays the information of the folder in one upper hierarchy.
4. Touching ▲ ▼ button of the scrollbar scrolls up/down the screen by one line.
Touching ▲ ▼ button scrolls up/down the screen by one screen.
5. Touching a file name selects the file.
6. For operation of operating switches, refer to the following.
 - G1L → CSV, G1L → TXT... This section (2)
 - Delete..... This section (3)
 - Copy..... This section (4)
 - Move..... This section (5)
 - Rename..... This section (6)
 - Create Folder..... This section (7)
7. Touching [x] button closes the screen.

(2) Operation of G1L → CSV conversion G1L → TXT conversion

Logging file (G1L file) is converted to CSV file or Unicode text file that can be displayed/edited on PC.

1. Touch and select the G1L file to convert into a CSV file or a Unicode text file.
2. Touch the following button in accordance with destination file type.
 - CSV file: G1L → CSV button
 - Unicode text file: G1L → TXT button

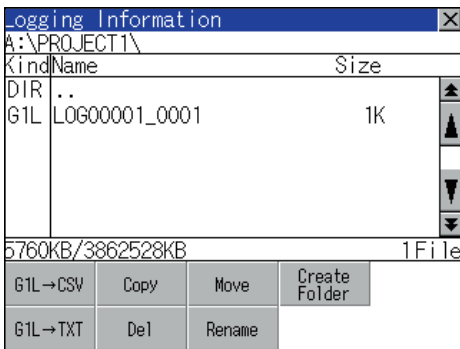

3. Select the target folder.
(Selecting a folder is not needed for outputting directly below the drive.)

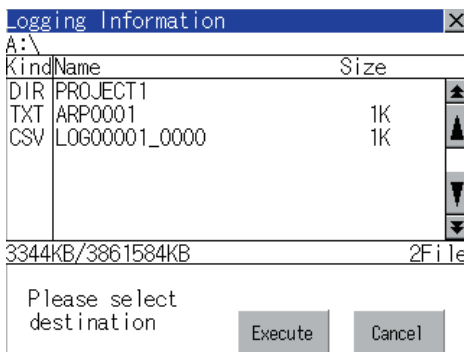

4. Touching [Execute] button displays the dialog box shown left.
Touch [OK] button.
(While executing, "Processing..." message appears on the screen.)

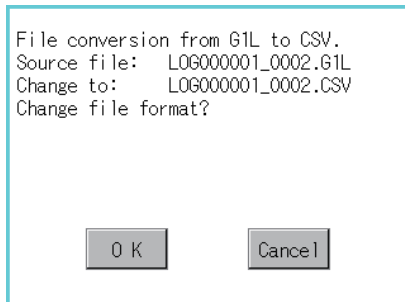

(Example: Dialog box if the [G1L → CSV] button is touched.)

5. When the file, whose name is the same, exists in the destination folder, the dialog box shown at left appears without starting the conversion.
Touching [OK] button overwrites the file.
Touching [Cancel] button cancels the conversion.

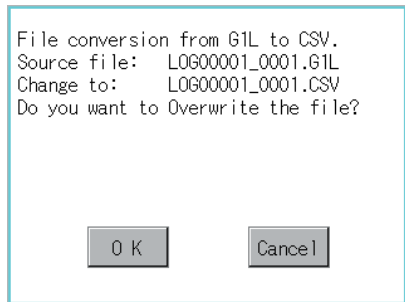

6. The message of completion is displayed in dialog box when conversion is completed.
Touching [OK] button closes the dialog.

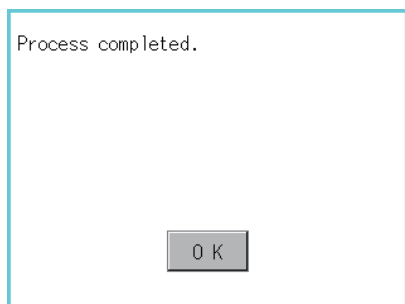

- (3) Deletion operation
Folder and file to be used on logging are deleted.

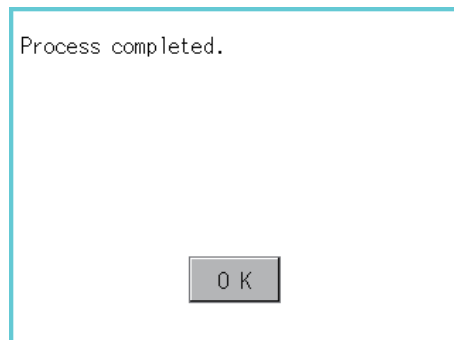
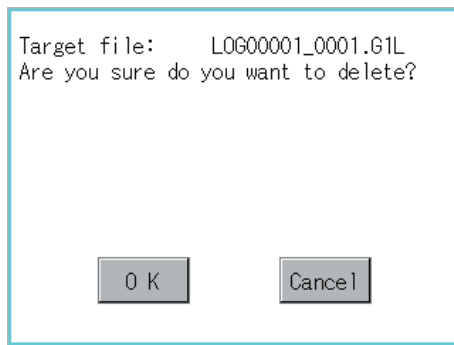
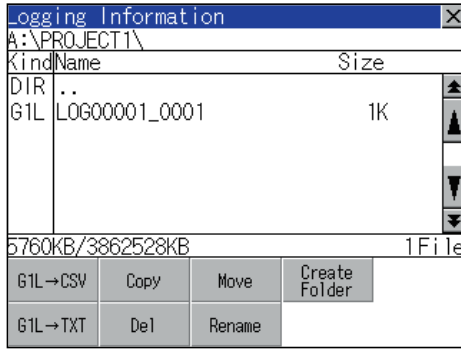

1. Touch and select the file/folder to delete.

2. Touching [Del] button displays the dialog mentioned left.
Touching [OK] button deletes the file/folder. (While executing, "Processing..." message appears on the screen.)
Touching [Cancel] button cancels the deletion.

3. When the deletion is completed, the completion dialog is displayed.
Touching [OK] button closes the dialog.

4. When it cannot be deleted, the dialog box shown at left appears. (Only when deleting folder is executed.)
Verify that there is no file in the folder and execute the delete operation again.
(☞ 13.2.6 ■ Precautions)

- (4) Copy operation
Folder to be used in logging is copied.

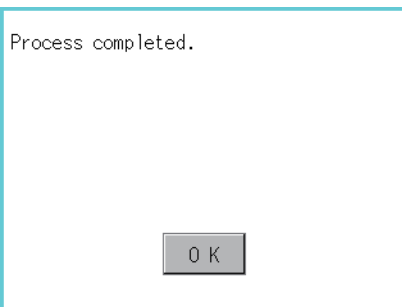
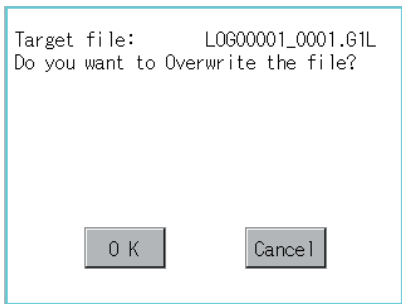
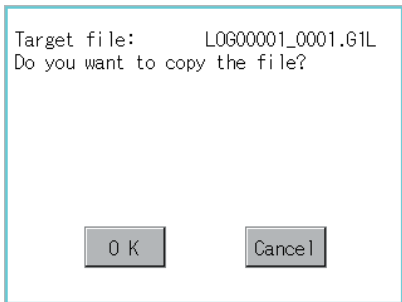
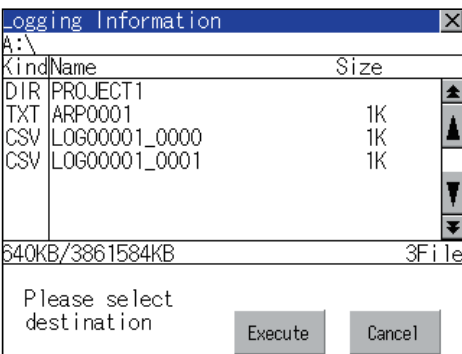
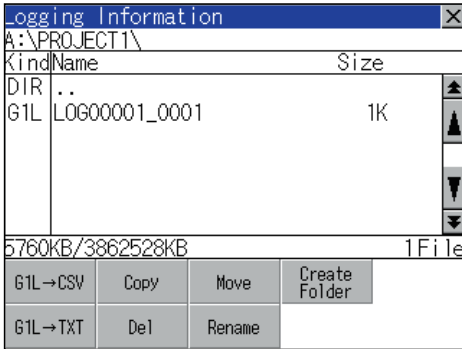

1. Touch and select the file to copy.
2. Touch the [Copy] button.
3. Select the target folder.
(Selecting a folder is not needed for outputting directly below the drive.)
At this time, it cannot be copied into the same folder where the file exists.
Select other folders.
4. Touching [Execute] button displays the dialog box shown left.
Touch [OK] button.
(While executing, "Processing..." message appears on the screen.)
5. If there is a file of the same name in the copy destination folder, the following dialog is displayed without starting the copy.
Touching [OK] button overwrites the file.
Touching [Cancel] button cancels the copy.
6. When the copy is completed, the dialog of completion is displayed.
Touching [OK] button closes the dialog.

- (5) Move operation
An operation log file is moved.

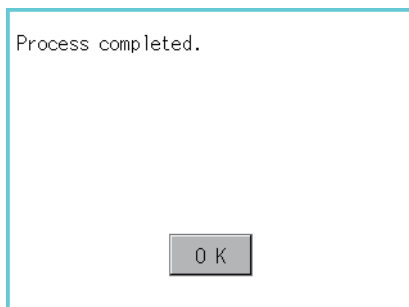
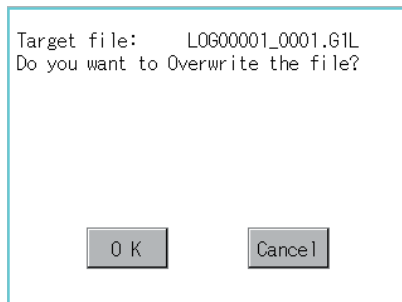
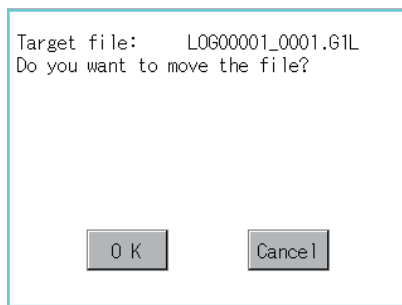
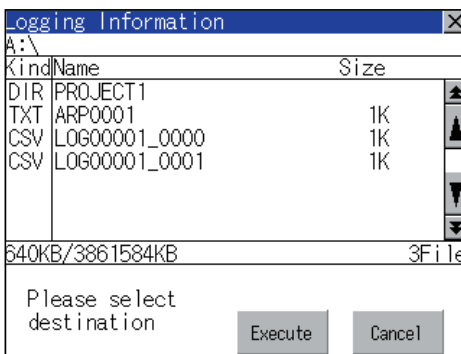
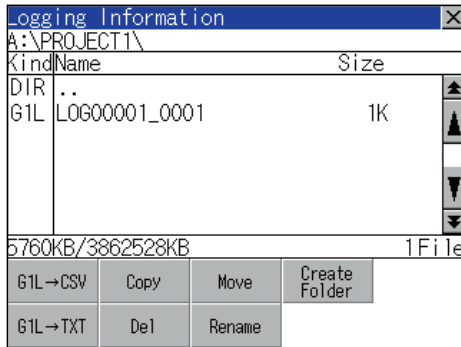

1. Touch and select the file to move.
2. Touch the [Move] button.
3. Select the target folder.
(Selecting a folder is not needed for moving directly below the drive.)
4. Touching [Execute] button displays the dialog box shown left.
Touch [OK] button.
(While executing, "Processing..." message appears on the screen.)
5. When any file with the same name exists in the destination folder, the dialog box shown left appears without starting the movement.
Touching the [OK] button overwrites the file.
Touching [Cancel] button cancels moving.
6. When moving is completed, completion dialog box is displayed.
Touching [OK] button closes the dialog.

- (6) Rename operation
An operation log file is changed.

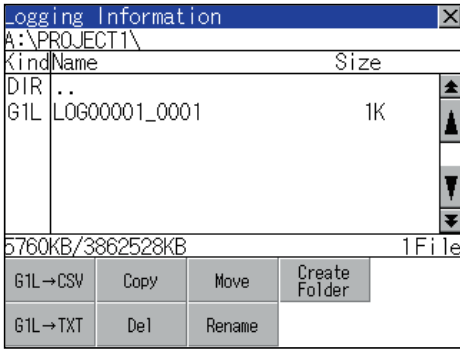

1. Touch and select the file to change the name.

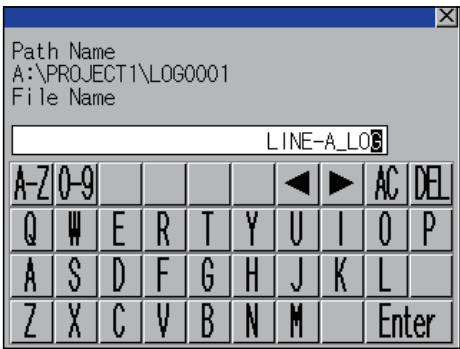

2. Touching [Rename] button displays the screen shown left. Input the file name to be changed. By touching the following button, input text type is changed.

[A-Z]: English capital
[0-9]: Numeric/Symbol

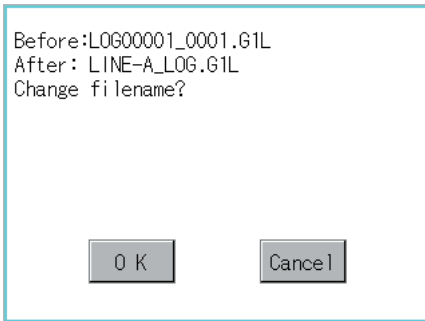

3. Touching [Enter] button displays the dialog box shown left.
4. Touching [OK] button starts renaming file. (While executing, "Processing..." message appears on the screen.)

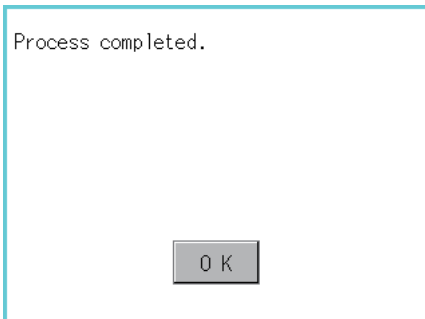

5. When renaming is completed, completion dialog box is displayed. Touching [OK] button closes the dialog.

- (7) Folder create operation
An operation log folder is created.

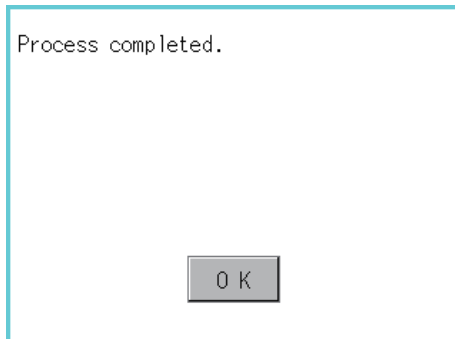
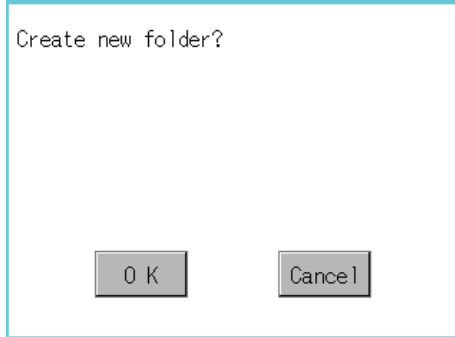
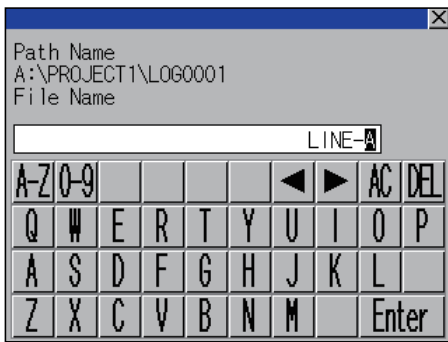
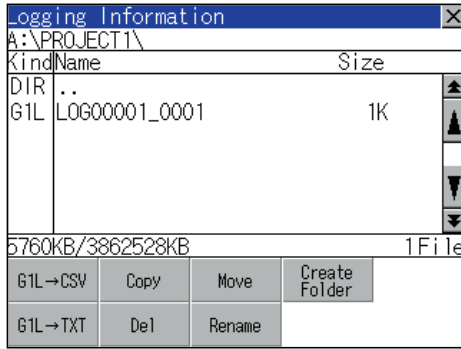

1. Touch the [Create Folder] button.
2. The input key window shown left appears, then input the file name to be created.
By touching the following button, input text type is changed.

[A-Z]: English capital
[0-9]: Numeric/Symbol

3. Touching [Enter] button displays the dialog box shown left.
4. Touching [OK] button starts creating folder.

5. When creating folder is completed, completion dialog box is displayed.
Touching [OK] button closes the dialog.

■ Precautions

(1) When creating folder/file

- (a) Number of characters set for folder or file name when creating folder/file.
GOT recognizes file location according to path explained below.
Specify folder or file name, and total characters of path cannot exceed 78 characters.
Users only can rename folder or file name.
(Other than folder/file name is automatically printed.)

Example: CSV file Path in SD card or USB memory

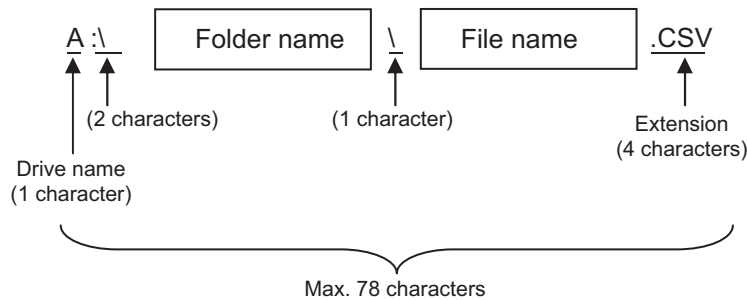

POINT

If folder is assigned the hierarchy.

The \ mark is displayed between folder name and folder name, folder name and file name. The \ mark is also counted as one character.

(b) Character strings that cannot be set to folder/file

The following character strings cannot be used as a folder name or a file name. Even small characters of those cannot be used.

- COM1 to COM9
- LPT1 to LPT9
- AUX
- CON
- NUL
- PRN
- CLOCK\$

In addition, the folder/file name shown below cannot be used.

- The folder name which begins with G1.
- Folder name and file name which begin with . (period).
- Folder name and file name which finish with . (period).
- Folder name and file name which have only . (one period) or ..(two periods).

(c) For deleting the folder

The folder in which the file exists cannot be deleted.

Delete the folder after having deleted the files.

In addition, on the logging information screen, the files other than logging files are not displayed on GOT. When the folder, in which there is no file displayed on the screen, cannot be deleted, confirm whether there is other file in SD card or USB memory by using personal computer, etc.

(2) Precautions for operation

(a) Precautions during folder/file operation (Create/Delete/Copy/File output, etc)

Even if SD card access switch has been turned OFF while GOT is processing folders and files, the processing continues to be executed.

(Example: Even if SD card access switch has been turned OFF while GOT is creating a folder, the folder is created.)

Therefore, do not pull out the SD card while the "Processing..." message is on the screen after SD card access switch has been turned OFF.

(b) While GOT is accessing to other file (Alarm data, etc)

When folder/file processing for the logging is executed while the GOT is in access to other files (SD card access LED ON), the GOT executes folder/file processing for the logging after the processing for other files is completed.

Therefore, it may take some time to finish the process of the logging folder/file.

(The "Processing..." message is displayed on the screen.)

13.2.7 Memory card format

- Function of the memory card format
Format the SD card/USB memory/Internal SRAM.
- Display operation of Memory card Format

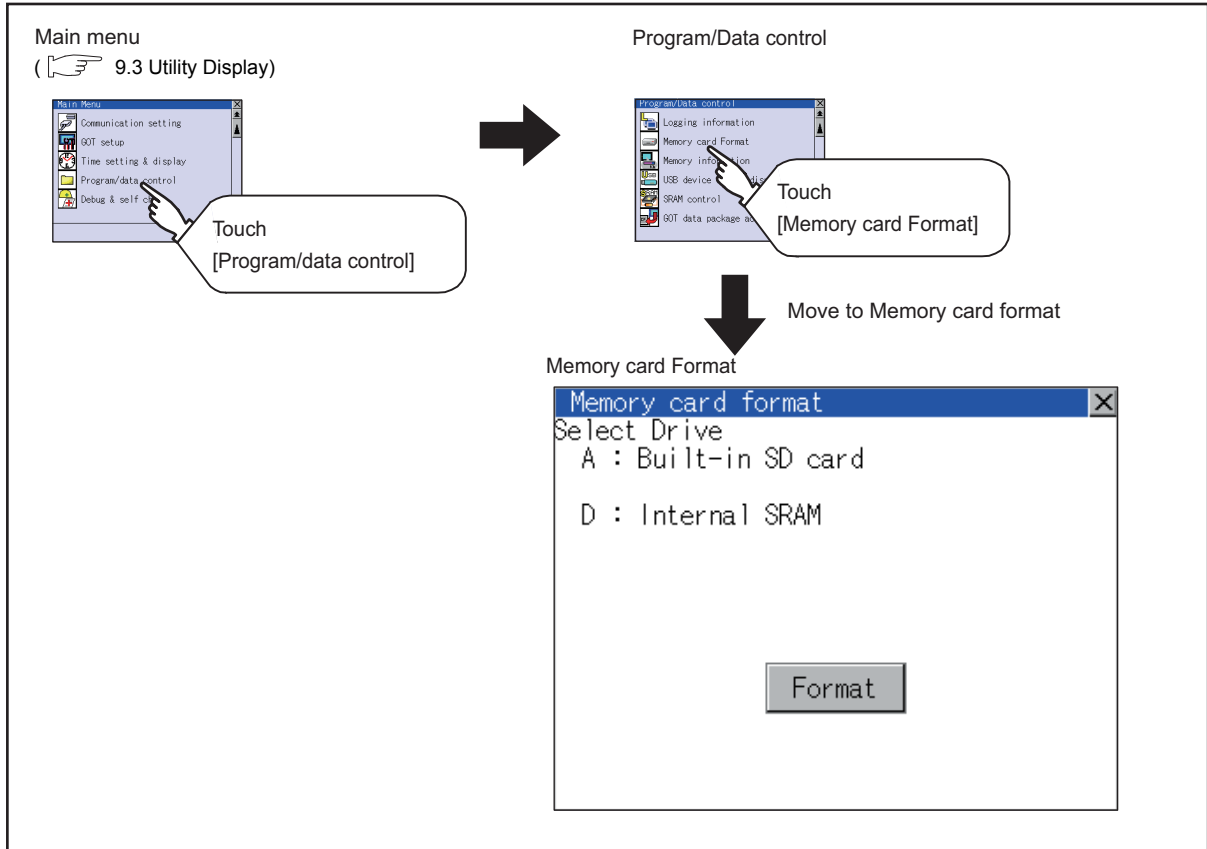

■ Memory card format operation

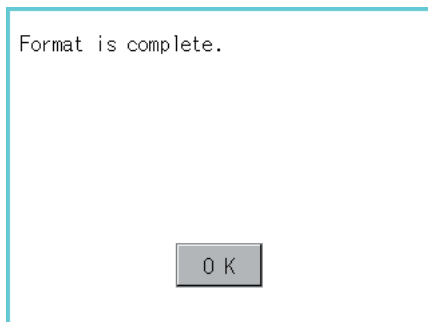
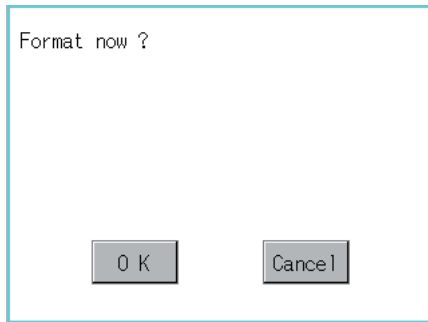
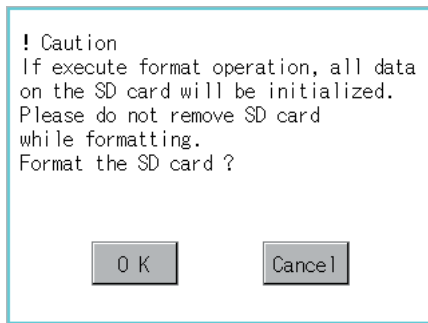
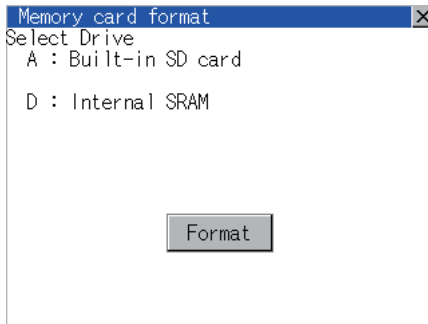

1. Mount the SD card/USB memory to GOT.
For inserting/removing method of SD card/USB memory, refer to the following.
 - ☞ 8.1.2 Installing and removing procedures of the SD card
 - 8.2.2 Installing and removing procedures of the USB memory
2. Touch and select the drive to format by drive selection.
3. Touching [Format] button displays the password input screen.
4. Typing and touching the [Enter] key display the dialog box shown on the left. (The password is fixed to 1111.)
Confirm the contents of the dialog box, and touch [OK] button when execute the format of SD card or USB memory.
To cancel the memory card format, touch [Cancel] button.
5. When touching the [OK] button in 4., the dialog box shown left appears for recheck.
6. Reconfirm whether to format the SD card or USB memory.
Touching the [OK] button starts the format.
Touching the [Cancel] button cancels the format of SD card or USB memory.
7. When the formatting is completed, the completion dialog mentioned left is displayed.
8. Touching the [OK] button closes the dialog box.

POINT

Restrictions on formatting

- When use an unformatted SD card or USB memory in GOT, format the SD card or USB memory by PC. GOT cannot format the unformatted SD card or USB memory.
- The formatting of GOT does not change the file system (Example: FAT16) of the SD card or USB memory and inherits the file system before formatting.

13.2.8 Memory information

Memory information functions

Displays the flash memory empty area size available for the user of each drive and Boot drive empty area size. Confirming memory empty space is enabled without connecting a PC.

Display operation of Memory information

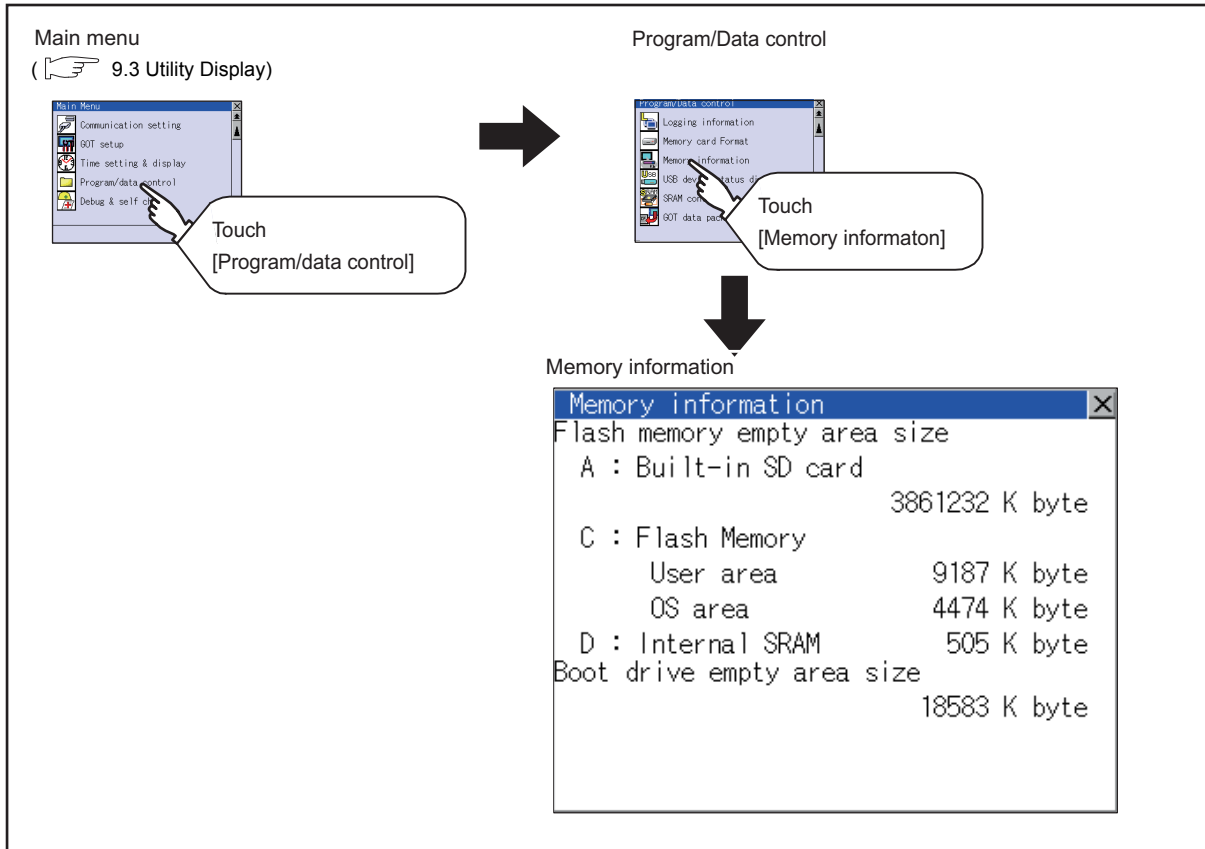

Display example of Memory information

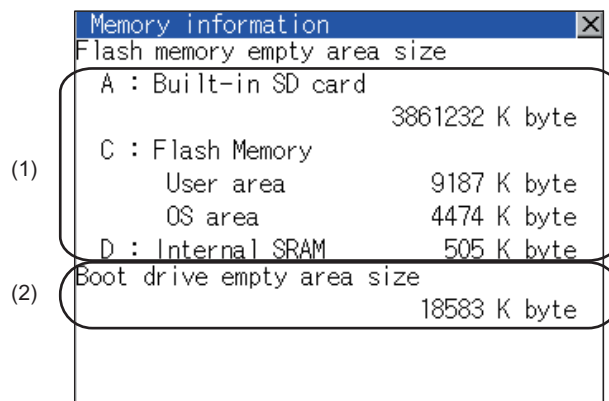

Number	Item	Description
(1)	Flash memory empty area size	Indicates the memory space of each drive available for the user to store files or folders. The [A: Built-in SD card] is not displayed when SD card is not installed. If the USB memory is not installed, [E: USB drive] is not displayed.
(2)	Boot drive empty area size	Indicates the empty area size of boot drive specified by the user.

13.2.9 USB device status display

■ Function of USB device status display

This function displays a list of the USB device connection status in the GOT.
Also, this screen is used to remove the USB device from GOT.

■ Display operation of USB device status display

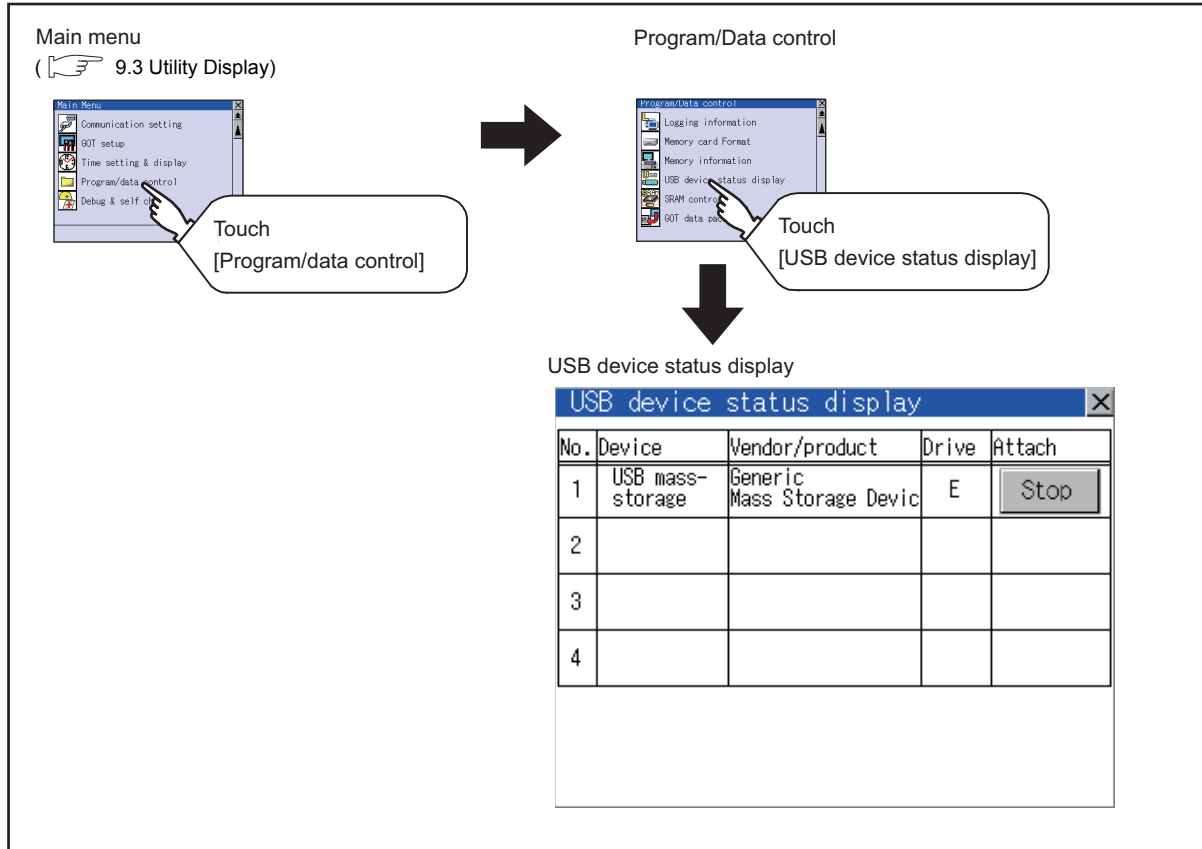

■ USB device status display operation

No.	Device	Vendor/product	Drive	Attach
1	USB mass-storage	Generic Mass Storage Device	E	Stop
2				
3				
4				

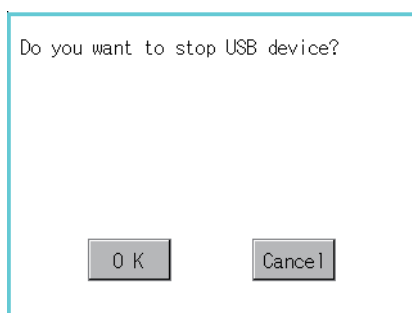

1. When the USB device is installed to GOT, the screen shown left is displayed.
2. USB mass storage is displayed in Device, and [Stop] button is displayed in Attach.
3. Touching the [Stop] button displays the dialog box shown left. Touching the [OK] button execute the preparation of the USB devices removal. Touching the [Cancel] button cancels the preparation of USB devices removal.
4. When the preparation of removal is ready, the dialog box shown left is displayed.
5. Touching the [OK] button closes the dialog box.

POINT

USB mouse/keyboard recognition

When using the USB mouse/keyboard, install [USB mouse/keyboard] of the extended function OS to the GOT.

13.2.10 SRAM control

■ Function of SRAM control

The SRAM user area usage can be confirmed, data in the SRAM user area can be backed up or restored, and the SRAM user area is initialized.

For the available functions in the SRAM user area, refer to the following.

 GT Designer3 Version1 Screen Design Manual (Functions)

■ Display operation of SRAM control

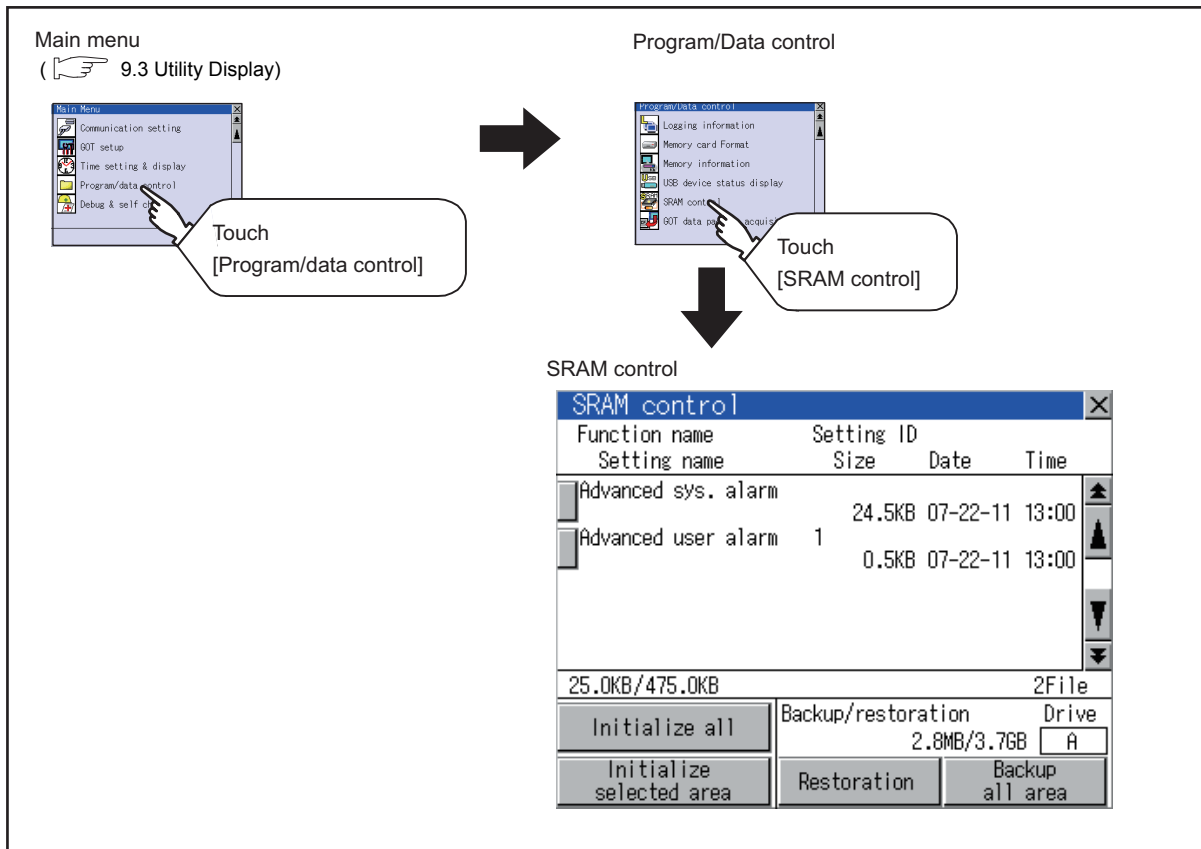

■ Display example of SRAM control

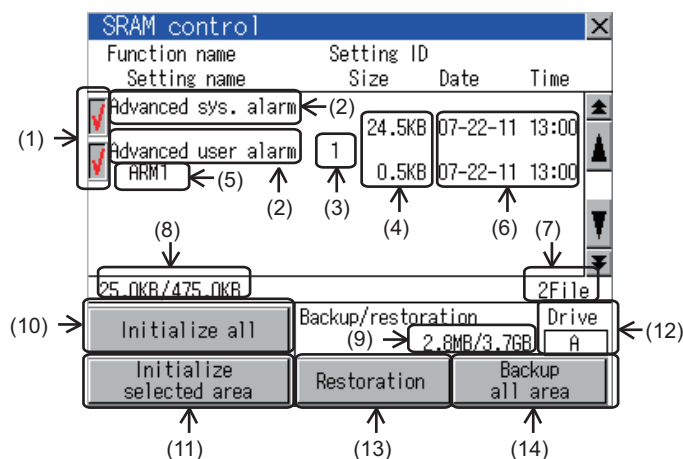

Number	Item	Description
(1)	Check box	Touch the check box to select or clear the item.
(2)	Function name	Displays the used functions in the order of the advanced system alarm, advanced user alarm, and logging function.
(3)	Setting ID	Displays the setting IDs. The setting IDs of the advanced system alarm are not displayed.
(4)	Size	Displays the data size.
(5)	Setting name	Displays the setting name. For the setting name, only characters within the display range are displayed.
(6)	Date and time	Displays the creation date and time of each data.
(7)	Number of selected files	Displays the information of the items currently selected.
(8)	SRAM area	Displays the current free space size or total size of the SRAM user area.
(9)	Drive space	Displays the current free space size or total size of the drive selected for [Select drive].
(10)	Initialize all	Initializes all areas of the SRAM user area.
(11)	Initialize selected area	Select each area of the SRAM user area to initialize multiple areas of the SRAM user area.
(12)	Select drive	Switches drives to be used for the data backup or restoration in the SRAM user area.
(13)	Restoration	Saves the data in the selected drive to SRAM user area. The following drives can be switched only when a SD card or USB memory is installed. • SD card: [A: Built-in SD card] • USB memory: [E: USB drive]
(14)	Backup all area	Saves data in the SRAM user area to the selected drive.

■ SRAM control operation

(1) Operation to initialize all or selected areas of the SRAM user area

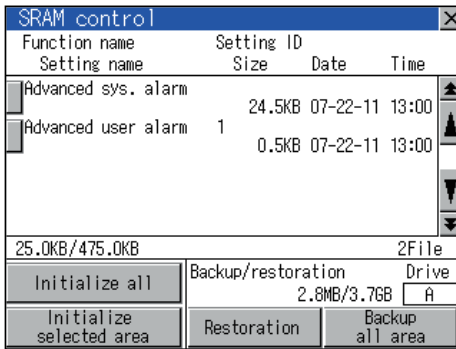

(Example: Dialog box when touching the [Initialize all] button)

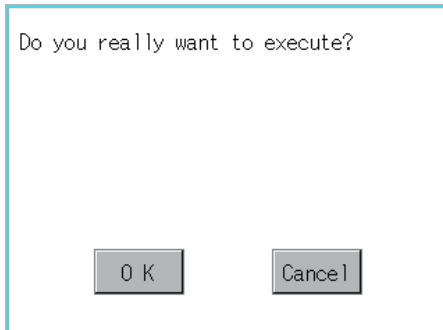
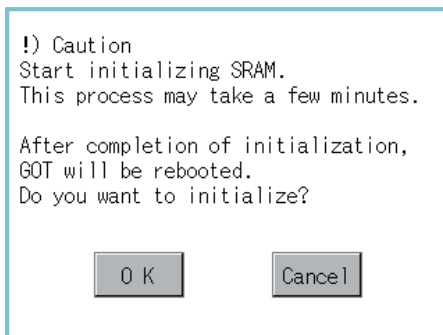

1. Perform any of the following operations.
 - To initialize all areas of the SRAM user area, touch the [Initialize all] button.
 - To initialize selected areas of the SRAM user area, select the check box of the area to be initialized, and then touch the [Initialize selected area] button.

2. The dialog box shown left appears. Check the description of the dialog box. To initialize the SRAM user area, touch the [OK] button. To cancel the initialization, touch the [Cancel] button.

3. When touching the [OK] button in 2., the dialog box shown left appears for recheck.

Touching the [OK] button starts the initialization. Touching the [Cancel] button cancels the initialization.

4. The completion dialog box appears when the initialization is completed. Touching the [OK] button closes the dialog box.

(2) Operation to restore data

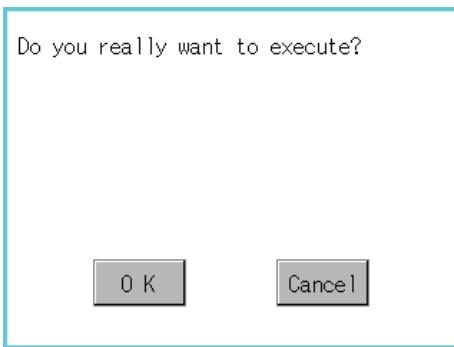
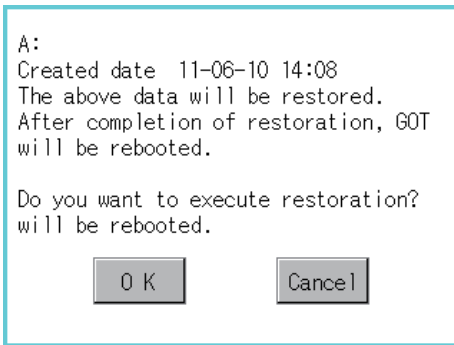
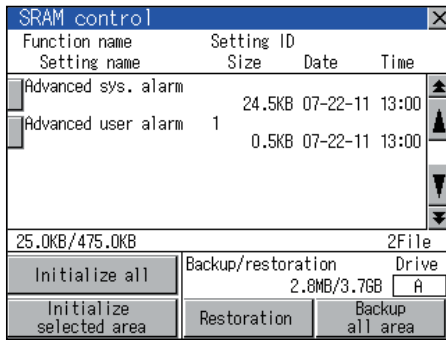

- To restore data in the drive to the SRAM user area Select the drive where the data is stored, and then touch the [Restoration] button.
- The dialog box shown left appears. Check the description of the dialog box. To restore all data in the SRAM user area, touch the [OK] button. To cancel the restoration, touch the [Cancel] button.
- When touching the [OK] button in 2, the dialog box shown left appears for recheck. Touching the [OK] button starts the restoration. Touching the [Cancel] button cancels the restoration.
- The completion dialog box appears when the restoration is completed. Touching the [OK] button closes the dialog box.

(3) Operation to back up all data in the SRAM user area

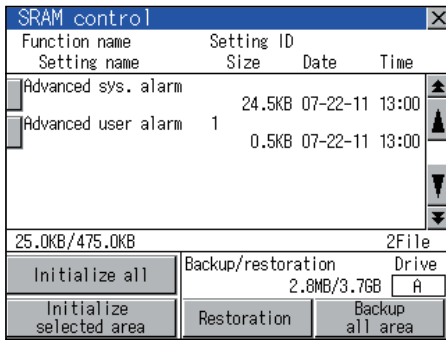

1. To back up data in the SRAM user area to a drive
 Select the drive where the data is to be stored, and then touch the [Backup all area] button.

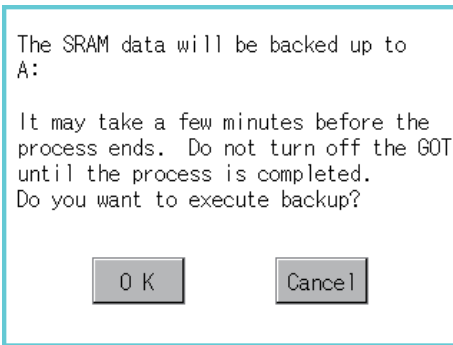

2. The dialog box shown left appears.
 Check the description of the dialog box. To back up all data in the SRAM user area, touch the [OK] button.
 To cancel the backup, touch the [Cancel] button.

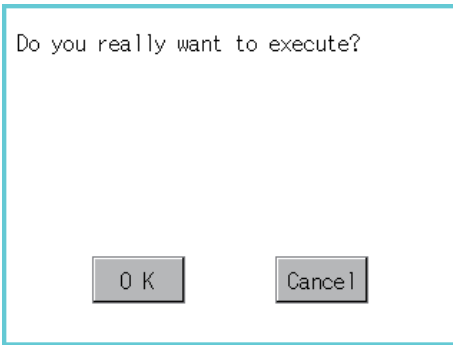

3. When touching the [OK] button in 2., the dialog box shown left appears for recheck.

Touching the [OK] button start the backup.
 Touching the [Cancel] button cancels the backup.

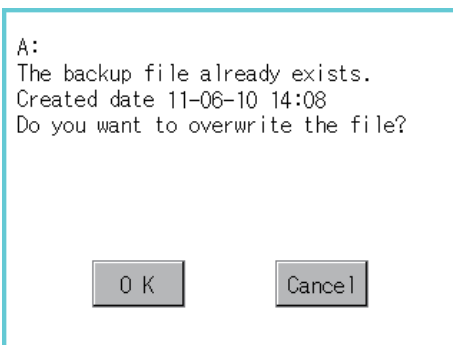

4. When the file, whose name is the same, exists in the destination folder, the dialog box shown left appears without starting the backup.
 Touching [OK] button overwrites the file.
 Touching the [Cancel] button cancels the backup.

5. The completion dialog box appears when the restoration is completed.
 Touching the [OK] button closes the dialog box.

13.2.11 GOT data package acquisition

■ GOT data package acquisition function

The GOT data package acquisition copies the installed OS or data in the GOT main unit to the SD card or USB memory.

- OS (Boot OS, standard monitor OS, communication driver, extended function OS, option OS)
- Special data
- Project data

The copied data can be utilized for backup or creating the same GOT system by installing the data. For installation function of the GOT, refer to the following.

 16.3 BootOS and Standard Monitor OS Installation Using SD card or USB Memory

■ Display operation of GOT data package acquisition

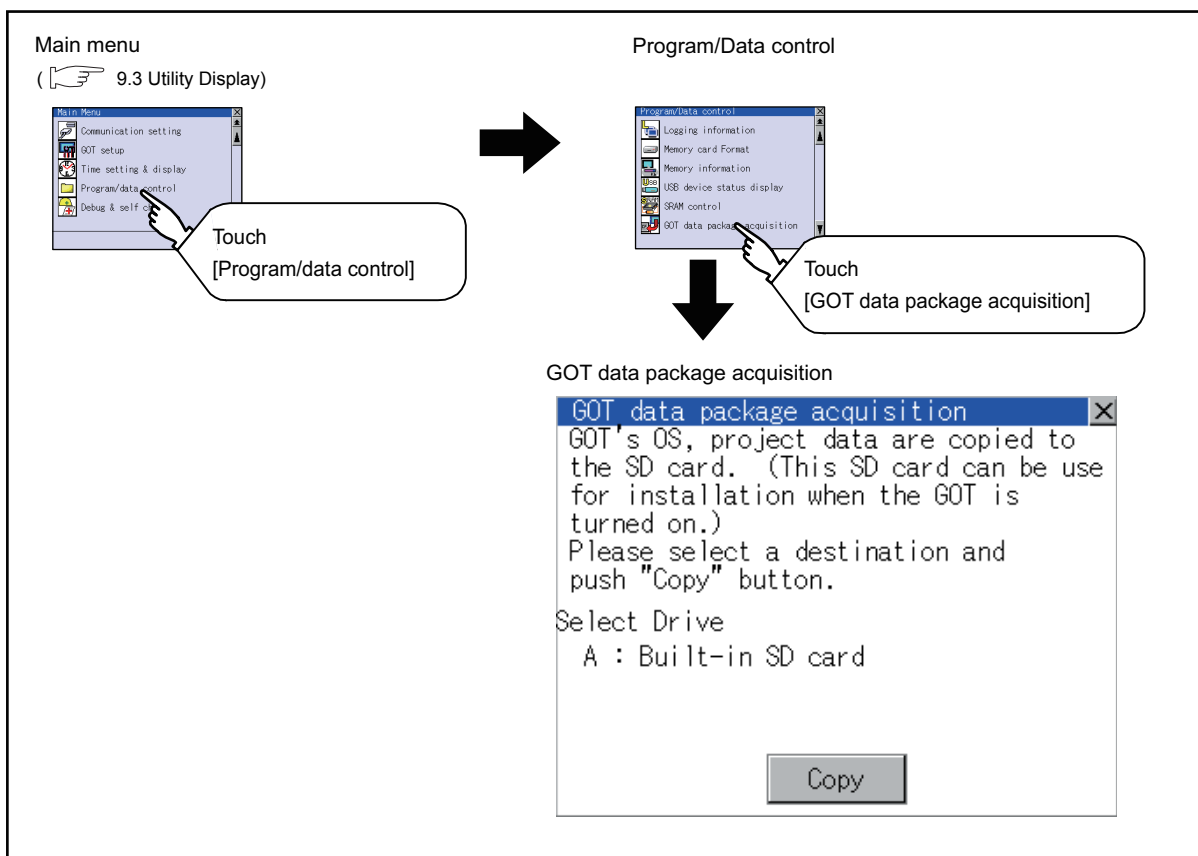

13.2.12 Operator information management

■ Operator management

(1) Operator management function

The function enables displaying a list of the operator information and adding, changing, or deleting the operator information to be used.

A password for operator authentication can be changed when the password is out of date.

Functions for the operator authentication (automatic logout time, authentication method, password expiration date, etc.) can be set.

For details of operator authentication functions, refer to the following manual.

 GT Designer3 Version1 Screen Design Manual (Fundamentals)

Function	Description	Reference
Operator management	Enables adding, editing, deleting, importing, and exporting the operator information.	13-74, 13-77
Add operation	Adds operator information to the GOT.	13-78
Edit operation	Edits the operator information stored in the GOT.	13-80
Delete operation	Deletes the operator information stored in the GOT.	13-81
Undo	Restores the current operator information to the previous saved one.	13-82
Import operation	Imports the operator information that is already exported to a SD card to the GOT.	13-83
Export operation	Exports the operator information stored in the GOT to a SD card.	13-84
Password change	Enables changing passwords to be used for login and logout in/out of the GOT.	13-85
Function setting	Enables setting the automatic logout time and password expiration date.	13-87

(2) Display operation of operator management

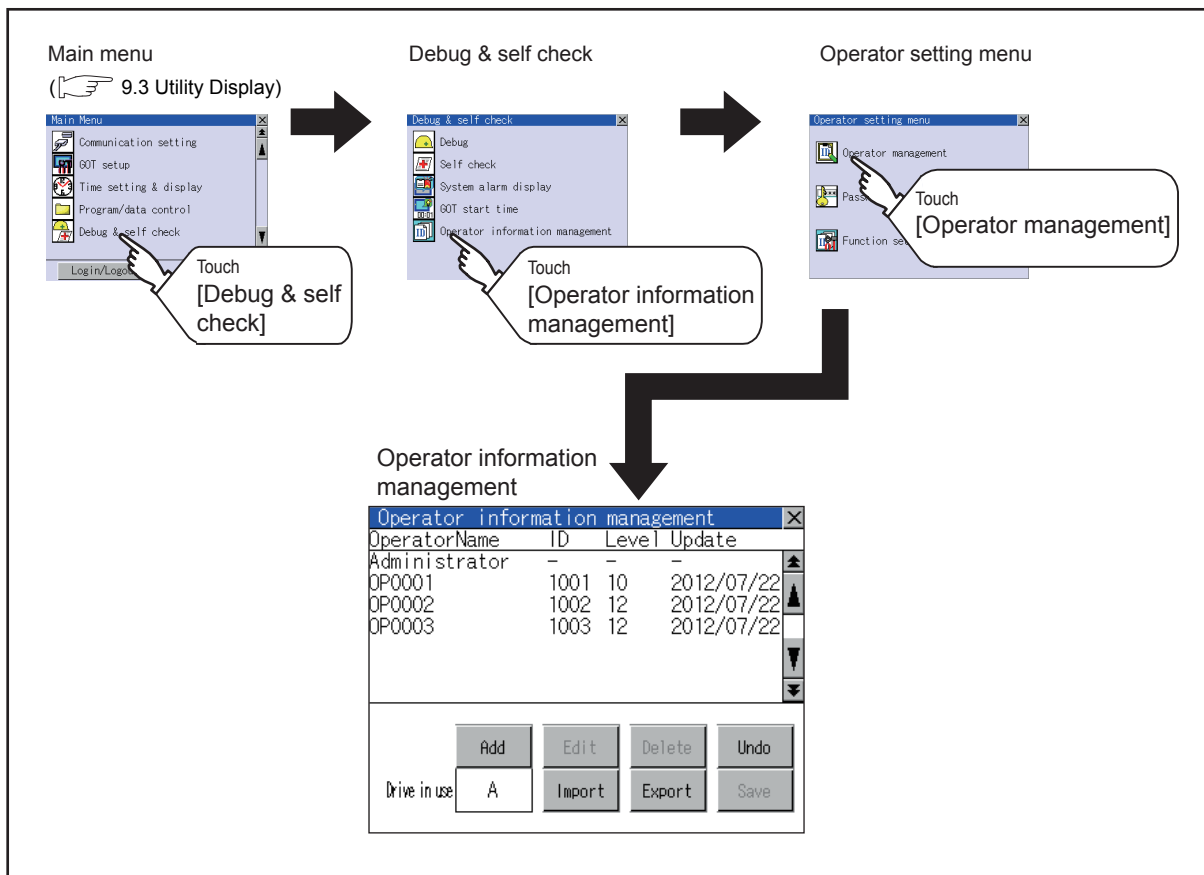

- (3) Display example of operator management
 (a) Operator information management screen

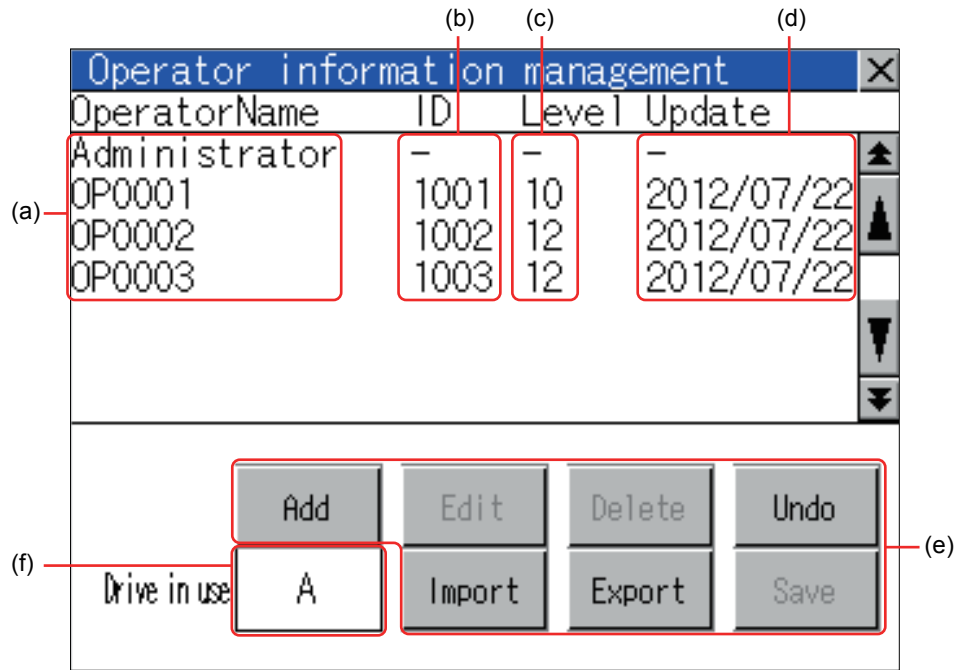

No.	Item	Description
(a)	Operator Name	Displays operator names.
(b)	ID	Displays operator IDs.
(c)	Level	Displays security levels for operators.
(d)	Update	Displays the last updated dates of the operator information.
(e)	Operation keys	Execution keys for each function
(f)	Drive in use	Displays and sets the storage location for imported and exported operator information. Touch the item, and then the display switches. (A: Built-in SD card) The display switches only when USB drive is installed on the GOT.

(b) Operator information edit screen

Touch the [Add] button or touch the [Edit] button with the operator information selected on the Operator information management screen, and then the Operator information edit screen is displayed. The operator information can be edited.

No.	Item	Description
(a)	Operator Name	The operator name to be edited is displayed or input an operator name to be added. (Up to 16 alphanumeric characters)
(b)	Operator ID	The operator ID to be edited is displayed or input an operator name to be added. (Setting range: 1 to 32766, Maximum number of registrations: 255)
(c)	Level	The operator security level to be edited is displayed or input an operator security level to be added. (0 to 15)
(d)	Password	Input a password. (Up to 16 alphanumeric characters.)
(e)	Make a permanent password	Switches the setting of the item disabled and enabled. (<input type="checkbox"/> : Disabled <input checked="" type="checkbox"/> : Enabled)
(f)	Use ext. auth. ID	Switches whether to use the external authentication ID. (<input type="checkbox"/> : Not Used <input checked="" type="checkbox"/> : Used)
(g)	Ext.auth. ID	The external authentication ID is displayed or input an external authentication ID. (External authentication ID setting range: alphanumerics*4 to 32 digits)  ■ Function setting

(4) Operator management operation

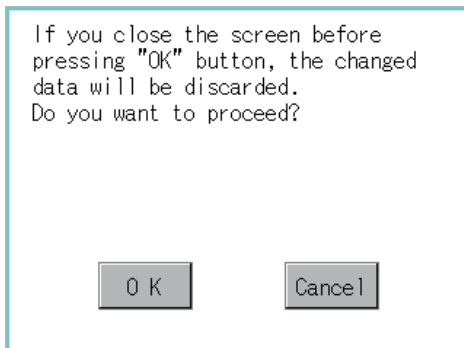
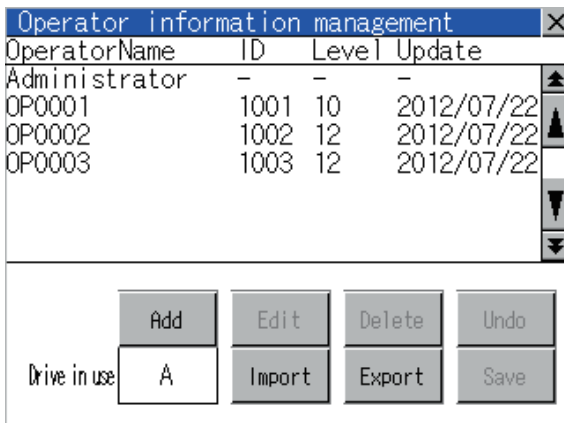
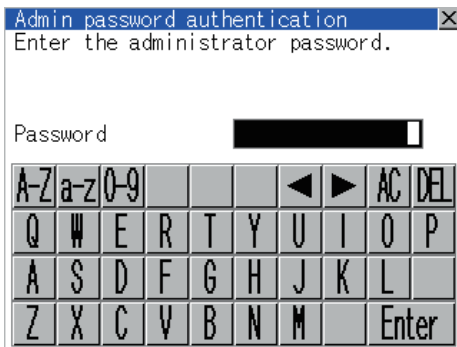
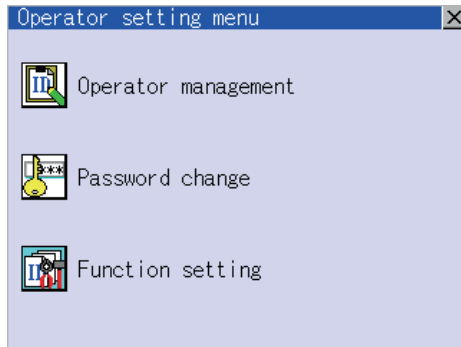

1. Touch [Operator management] in the operator setting menu.

2. The Admin password authentication screen is displayed, and then input the administrator password.
Character types to be input can be changed with touching the following buttons.

- A-Z : Alphabet capital
- a-z : Alphabet small letter
- 0-9 : Numeric

When the input is completed, touch the [Enter] key.

3. When the administrator password is correctly input, the Operator information management screen is displayed.

For operating operation switches, refer to the following.

- Add..... This section(4) (a)
- Edit..... This section(4) (b)
- Delete..... This section(4) (c)
- Undo..... This section(4) (d)
- Import..... This section(4) (e)
- Export..... This section(4) (f)

4. After all settings are completed, touch the [Save] button, and then the settings are saved.

Touch the button without touching the [Save] button, and then the dialog box shown left is displayed.

- (a) Add operation
Add operator information to the GOT.

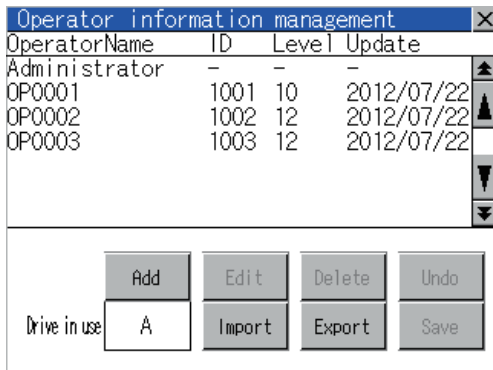

1. Touch the [Add] button.

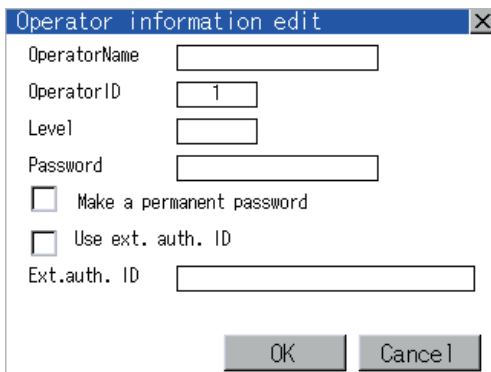

2. The Operator information edit screen is displayed, and then touch an item to be edited.

- (a) OperatorName
(b) OperatorID
(c) Level
(d) Password
(e) Make a permanent password
(f) Use ext. auth. ID
(g) Ext.auth. ID

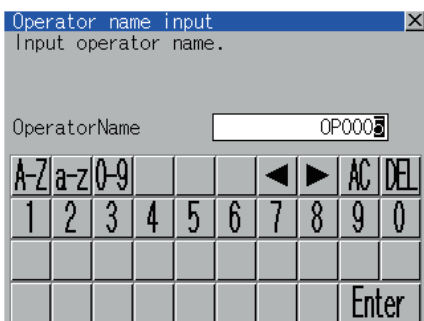

- (a) Touch the OperatorName, and then the Operator name input dialog box is displayed. Input an operator name.

Character types to be input can be changed with touching the following buttons.

[A-Z] : Alphabet capital

[a-z] : Alphabet small letter

[0-9] : Numeric

When the input is completed, touch the [Enter] key.

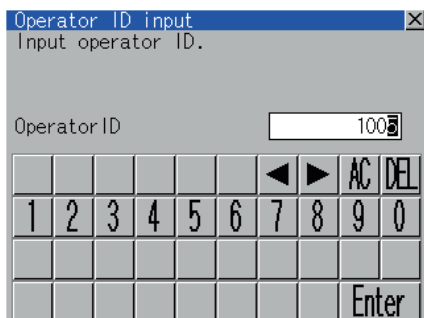

- (b) Touch the OperatorID, and then the Operator ID input dialog box is displayed.

Input an operator ID.

When the input is completed, touch the [Enter] key.

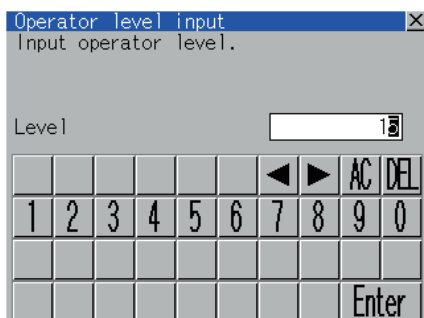

- (c) Touch the level, and then the Operator level input dialog box is displayed. Input an operator level.

When the input is completed, touch the key.

When the level of the operator being login is changed during editing the operator information, a new level is not reflected until you log out of the GOT once and log in the GOT again.

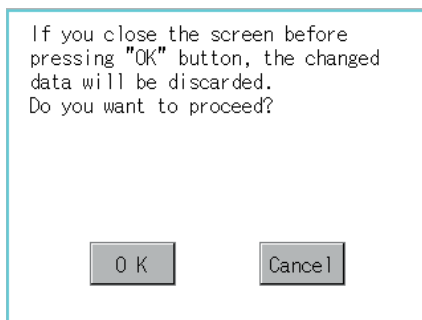
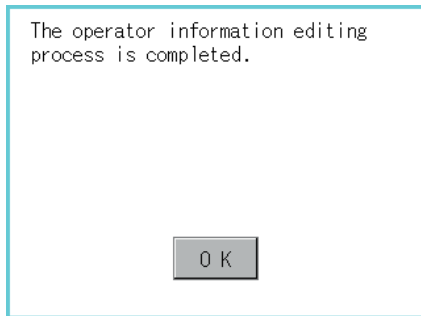
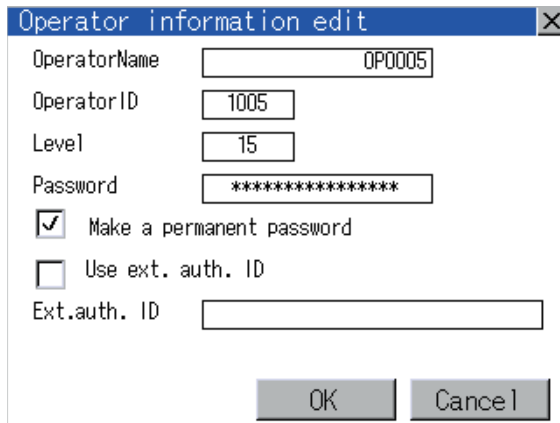
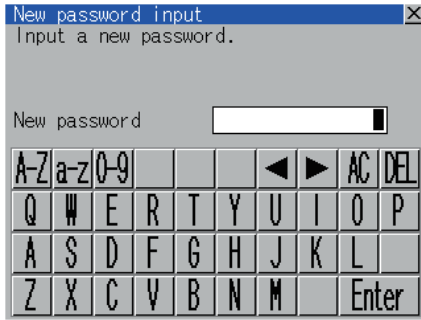

(d) For changing passwords during editing, touch the password.
The New password input dialog box is displayed, and then input a password.
When the input is completed, touch the [Enter] key.
When the password input is completed, the New password input confirmation dialog box is displayed.
Input the same password.

(e) For enabling the setting of [Make a permanent password], touch the check box for [Make a permanent password], and then the setting is switched.

: Disabled

: Enabled

(f) For using the external authentication ID, touch the check box "Use ext. auth. ID" and switch the setting.

: The external authentication ID is not used.

: The external authentication ID is used.

(g) Touch Ext.auth ID to display the external authentication ID input dialog box, and enter the external recognition ID. When the input is completed, touch the [Enter] key.

When the authentication method is set to "Fingerprint auth" or "External auth (general)", the external authentication ID can be input with the external authentication device.

3. Touch the [OK] button after all items are input, and then the dialog box shown left is displayed and the input operator information is added.

Touch the [Cancel] button or the button, and then the dialog box shown left is displayed.

- (b) Edit operation
 Edit the operator information stored in the GOT.

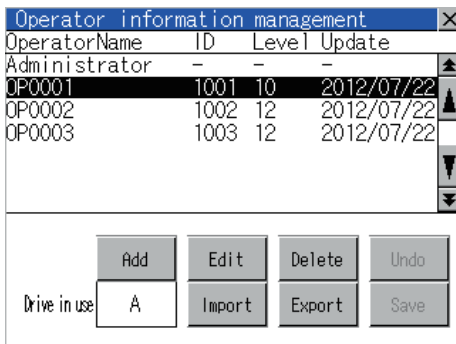

1. Select the operator information to be edited with touching the operator information.
2. Touch the [Edit] button.

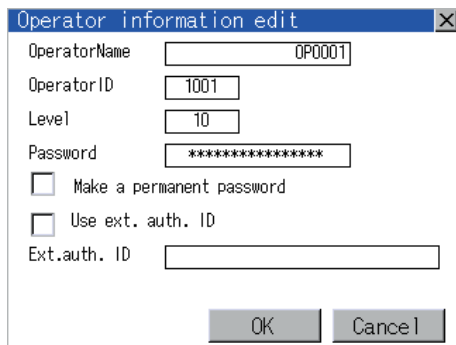

3. The Operator information edit screen is displayed, and then touch an item to be edited.
 - (a) Level
 - (b) Password
 - (c) Make a permanent password
 - (d) Use ext. auth. ID
 - (e) Ext.auth. ID
 For how to edit operator information, refer to the following.
 ☞ This section(4)

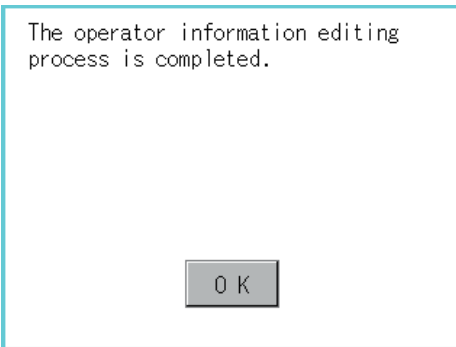

4. Touch the [OK] button after all items are input, and then the dialog box shown left is displayed and the input operator information is added.

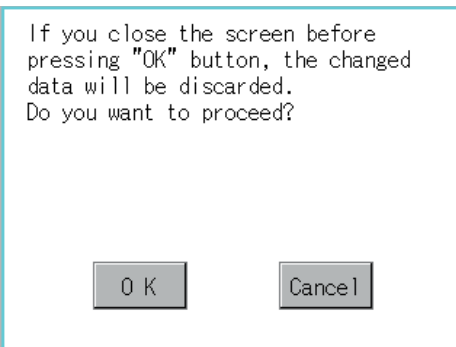

Touch the [Cancel] button or the ☒ button, and then the dialog box shown left is displayed.

(c) Delete operation

Delete the operator information stored in the GOT.

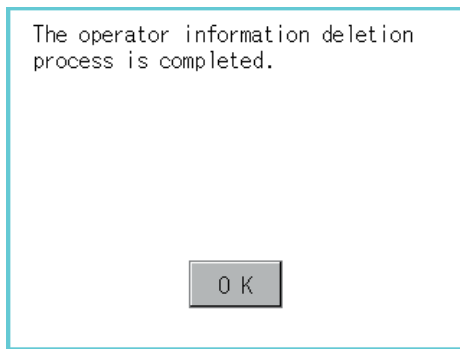
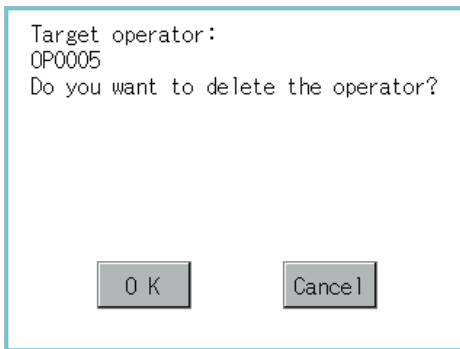
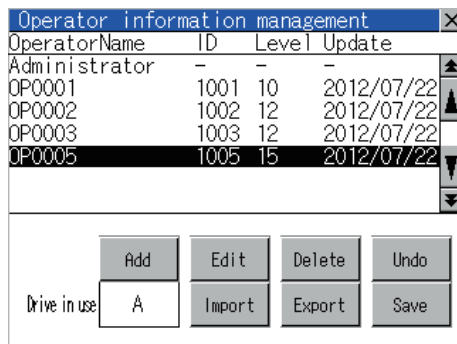

1. Select the operator information to be deleted with touching the operator information.
2. Touch the [Delete] button, and then the dialog box shown left is displayed.
3. Touch the [OK] button, and then the selected operator information is deleted. Touch the [Cancel] button, and then the delete operation is canceled.
4. When the delete operation is completed, a completion dialog box is displayed.
5. Touch the [OK] button, and then the dialog box is closed.

(d) Undo operation

Restore the current operator information to the previous saved one.

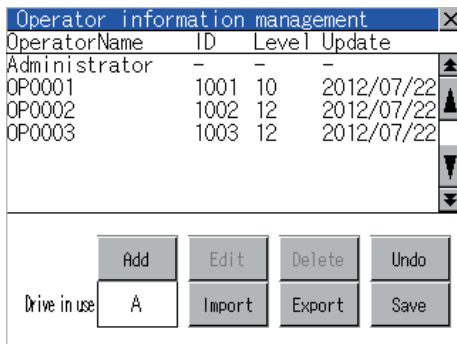

1. Touch the [Undo] button.

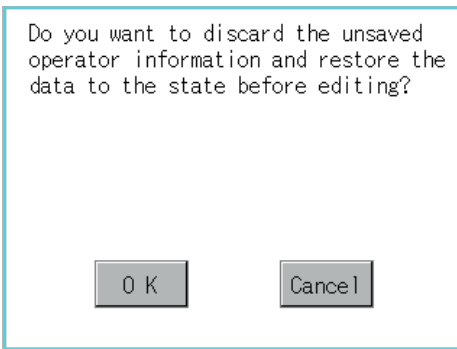

2. The dialog box shown left is displayed, and then touch the [OK] button.

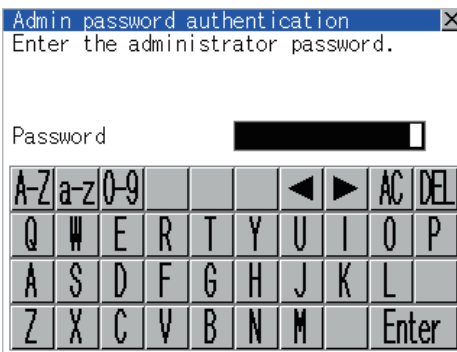

3. The Admin password authentication screen is displayed, and then input the administrator password. Character types to be input can be changed with touching the following buttons.

- : Alphabet capital
- : Alphabet small letter
- : Numeric

When the input is completed, touch the [Enter] key.

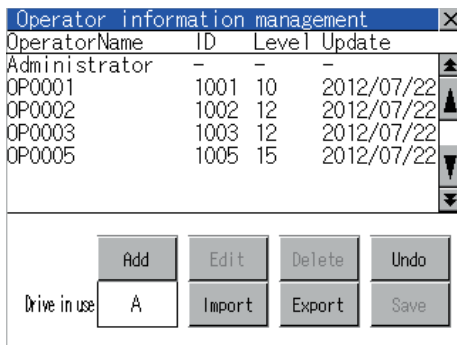

4. When the administrator password is correctly input, the current operator information is restored to the previous saved one.

(e) Import operation

Import the operator information that is already exported to a SD card to the GOT.

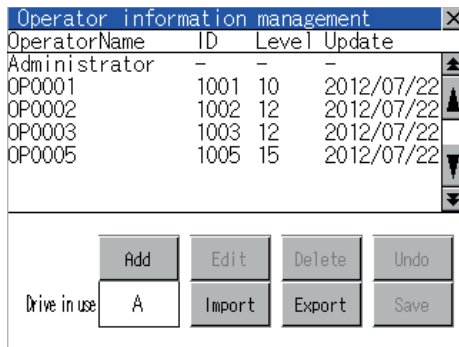

1. Touch the [Import] button.

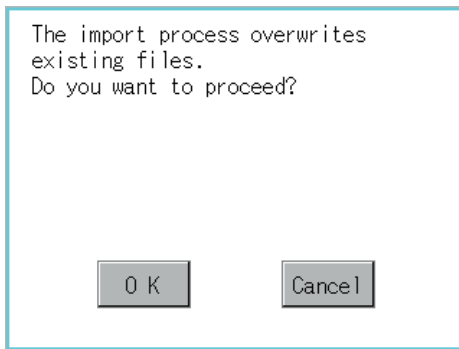

2. The dialog box shown left is displayed. Touch button, and then the Admin password authentication screen is displayed. Input the administrator password. Character types to be input can be changed with touching the following buttons.

- [A-Z] : Alphabet capital
- [a-z] : Alphabet small letter
- [0-9] : Numeric

When the input is completed, touch the [Enter] key.

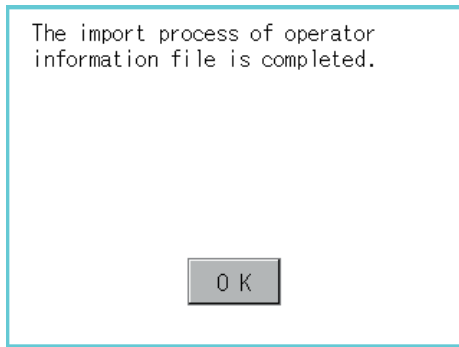

3. When the administrator password is correctly input, the dialog box shown left is displayed and the operator information stored in a SD card is imported to the GOT.

(f) Export operation

Export the operator information stored in the GOT to a SD card.

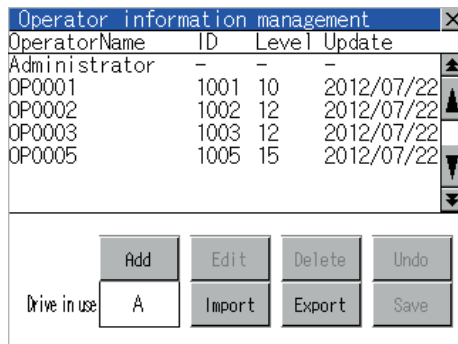

1. Touch the [Export] button.

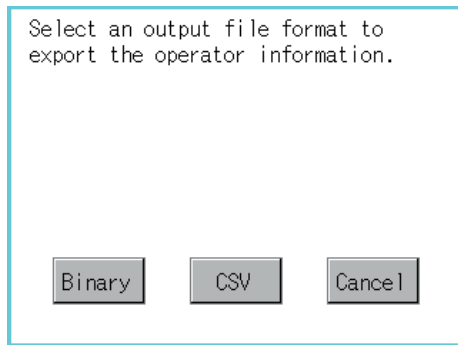

2. The dialog box on the left is displayed.

3. Touch the following buttons according to the output format for the file.

Binary file: button

CSV file: button

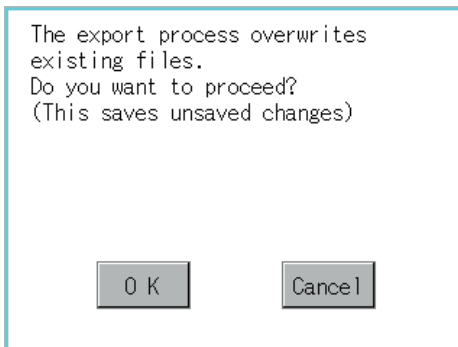

4. The dialog box shown left is displayed. Touch [OK] button, and then the Admin password authentication screen is displayed. Input the administrator password. Character types to be input can be changed with touching the following buttons.

: Alphabet capital

: Alphabet small letter

: Numeric

When the input is completed, touch the [Enter] key.

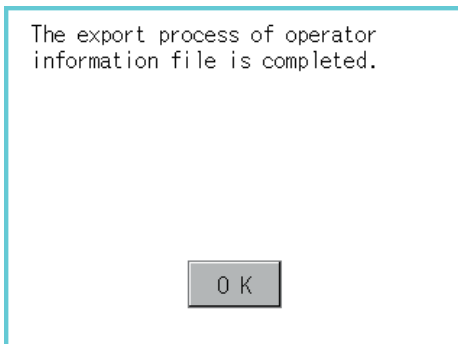

5. When the administrator password is correctly input, the dialog box shown left is displayed and the operator information stored in the GOT is exported to a SD card. (file name: AUTHINF.G1U)

■ Password change

(1) Password change function

The passwords to be used for the operator authentication can be changed.

For the password change, log into the GOT in advance with the operator name corresponding to the password to be changed.

(2) Display operation of password change

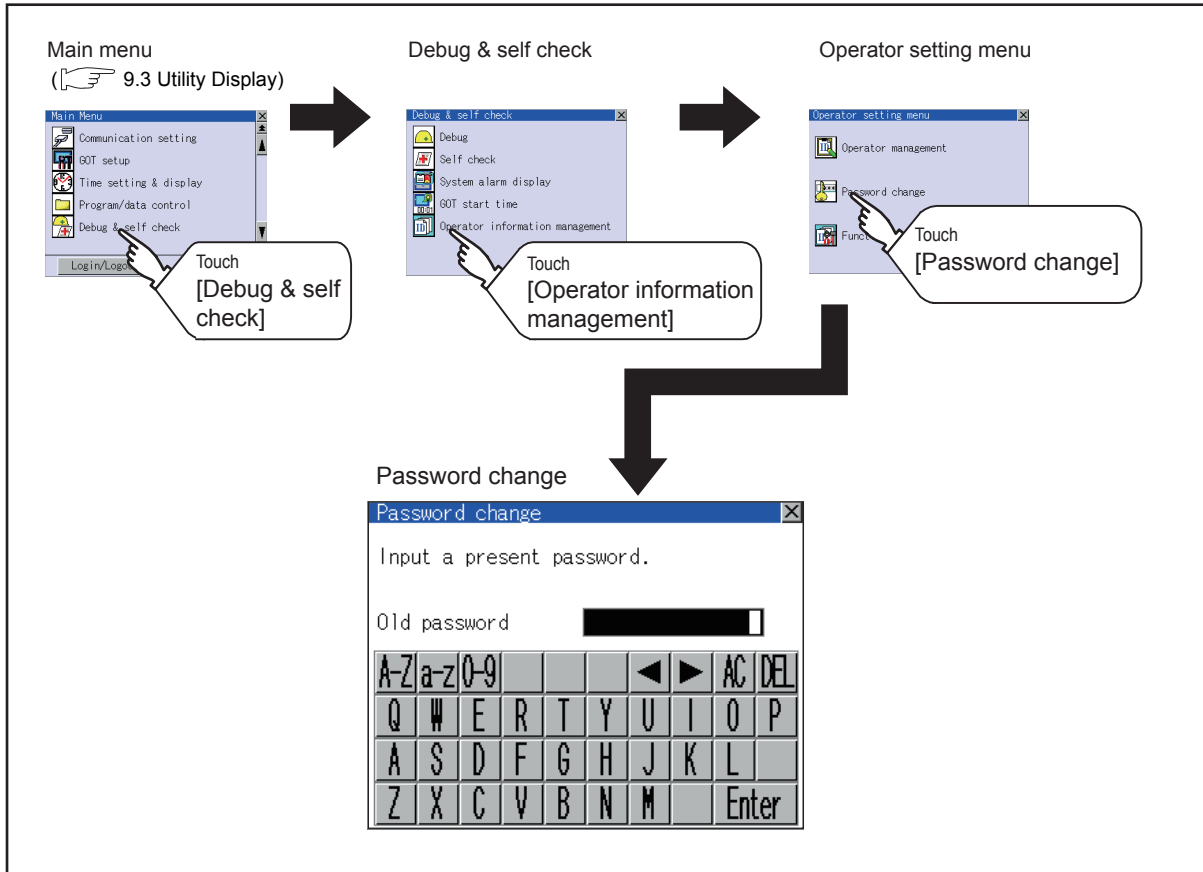

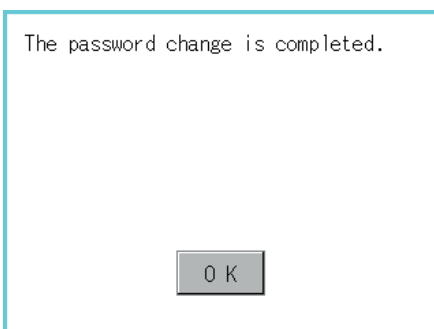
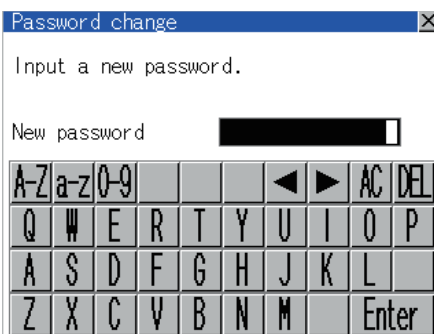
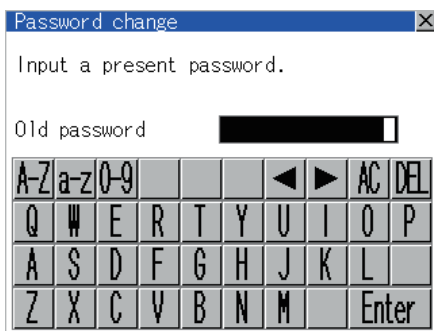
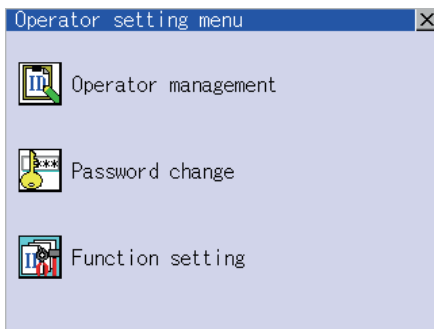
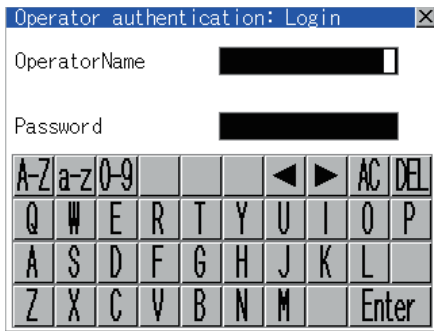

(3) Password change operation



1. Log into the GOT with the operator name corresponding to the password to be changed on the Main Menu screen for the utility.

2. Touch [Password change] in the operator setting menu, and then the Password change dialog box is displayed.

3. Input the current password on the Password change dialog box. Character types to be input can be changed with touching the following buttons.

-  : Alphabet capital
-  : Alphabet small letter
-  : Numeric

When the input is completed, touch the [Enter] key.

4. Input a new password.

5. After inputting a new password, input the new password again.

6. When the new password is correctly input, the dialog box shown left is displayed and the password is changed.

■ Function setting

(1) Function setting function

The functions for the operator information can be set.
The following items can be set.

Items	Description	Reference
Automatic logout time	The time from when the last time the GOT is operated until when you automatically log out of the GOT can be set. (1 to 60 minutes, 0 is invalid.)	13-88
Auth method	The authentication method can be switched. ([Operator name + password], [External auth (general)]) When [External auth (general)] is selected, the check box for [Operator name + password] is displayed.	13-88
Password expiration date	Set the item for regularly changing the password to be used for the operator authentication. (1 to 1000 days, 0 is invalid.) When the password is out of date after setting the password, the GOT requests the password change.	13-89
Initial position input	Set the initial position input (byte count) of external authentication ID from among the data read from the external authentication device. (0 to 1998 bytes)	-
Valid byte count input	Set the valid byte count for external authentication ID. (2 to 16 bytes)	

(2) Display operation of function setting

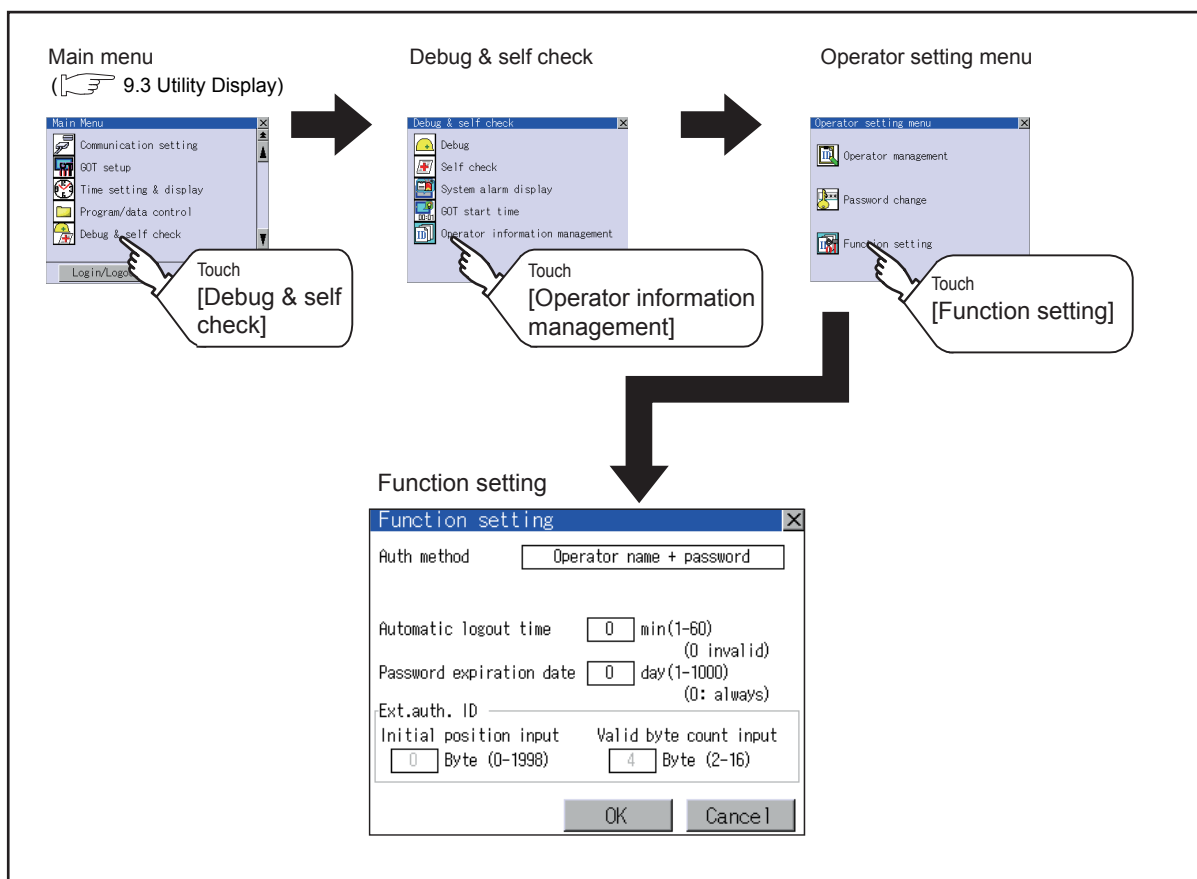

(3) Function setting operation

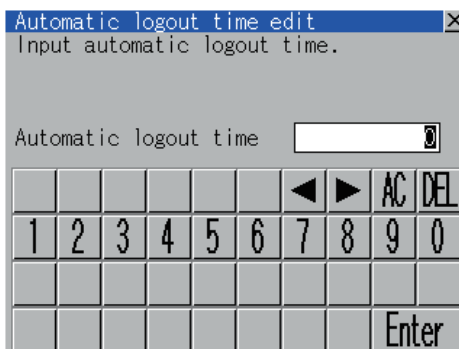
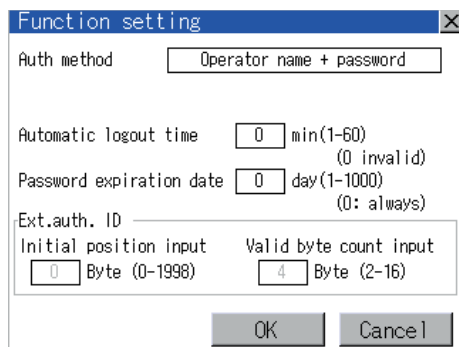
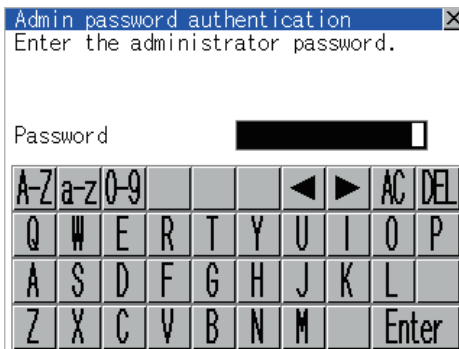
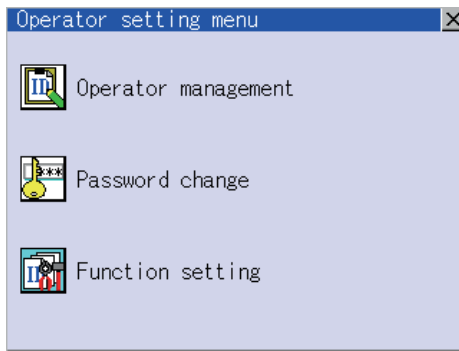

1. Touch [Function setting] in the operator setting menu, and then the Admin password authentication dialog box is displayed.

2. Input the administrator password. Character types to be input can be changed with touching the following buttons.

- : Alphabet capital
- : Alphabet small letter
- : Numeric

When the input is completed, touch the [Enter] key.

3. When the administrator password is correctly input, the Function setting screen is displayed. Touch an item to be set.

- (a) Automatic logout time
- (b) Auth method
- (c) Password expiration date
- (d) Initial position input
- (e) Valid byte count input

(a) Touch [Automatic logout time], and then the Automatic logout time edit dialog box is displayed. Input the time. When the input is completed, touch the [Enter] key.

(b) Authentication method
Switch the authentication method. Touch the item to switch the display between [Operator name + password] → [External auth (general)] → [Fingerprint auth] → [Operator name + password].

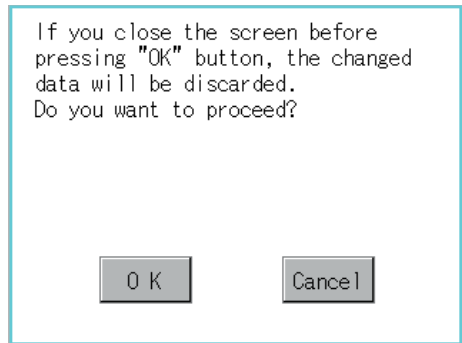
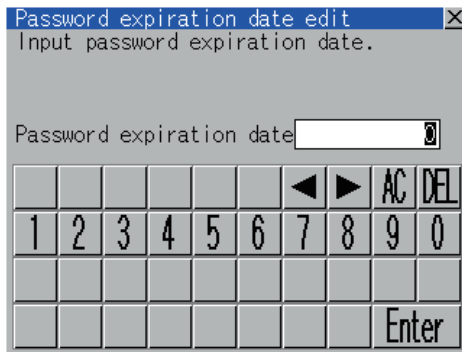

- (c) Touch [Password expiration date], and then the Password expiration date edit dialog box is displayed.
Input the expiration date.
When the input is completed, touch the [Enter] key.
 - (d) Initial position input
Set the initial position input (byte count) of external authentication ID from among the data read from the external authentication device.
 - (e) Valid byte count input
Set the valid byte count for external authentication ID.
(Only available when the external authentication (general) is set as the authentication method.)
4. Touch the [OK] button after all items are input, and then the dialog box shown left is displayed and the input setting is saved.

Touch the [Cancel] button or the  button, and then the dialog box shown left is displayed.

9	UTILITY FUNCTION
10	COMMUNICATION INTERFACE SETTING (COMMUNICATION SETTING)
11	DISPLAY AND OPERATION SETTINGS (GOT SET UP)
12	CLOCK SETTINGS AND BATTERY STATUS DISPLAY (TIME SETTING AND DISPLAY)
13	FILE DISPLAY AND COPY (PROGRAM/DATA CONTROL)
14	GOT SELF CHECK (DEBUG AND SELF CHECK)
15	CLEANING DISPLAY SECTION (CLEAN)
16	INSTALLATION OF COREOS, BOOTOS AND STANDARD

■ Display example of GOT data package acquisition

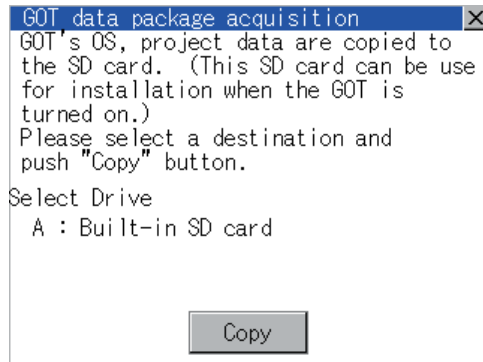

Number	Item	Description
(1)	Select drive	Displays the drive where OS and data can be copied. The [A: Built-in SD card] is not displayed when SD card is not installed. If the USB memory is not installed, [E: USB drive] is not displayed.
(2)	Copy	Touching the button starts copying.

■ GOT data package acquisition operation

(4) Display operation of GOT data package acquisition

The GOT data package acquisition copies the installed OS or data in the GOT main unit to the SD card or USB memory.

(This item explains using the A drive.)

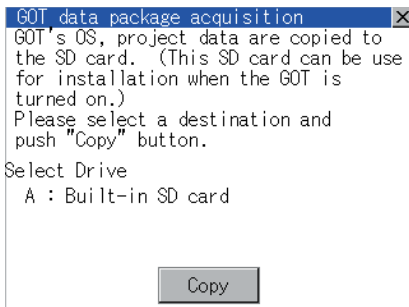

1. Touching the drive name below [Select Drive] inverts the touched drive name.
Touching the [Copy] button starts copying.

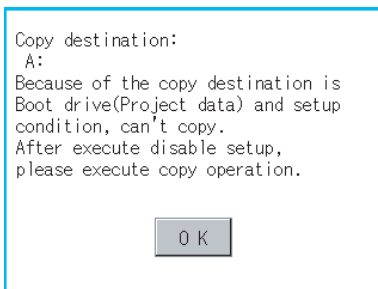

2. The display depends on the status of copy destination and setup.
Operate with following the displayed dialog box.

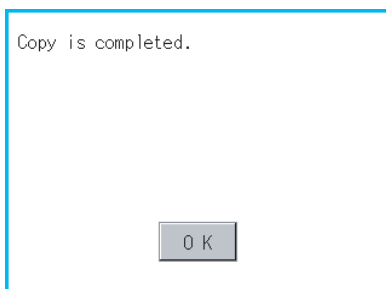

3. After copying OS and data, the dialog box for notifying the completion appears.
Touching the [OK] button closes the dialog box.

POINT

Estimation of processing time

The time required for the processing depends on conditions such as OS, data capacity, and file structure.
(Reference value)

- When the capacity is 4 Mbytes: Around 6 seconds
- When the capacity is 12 Mbytes: Around 18 seconds

(5) Precautions for operation

(a) Copying project data

If the Boot source drive and copy destination drive for project data is the same, the project data cannot be copied.

If the drives are the same, cancel the setup.

(b) When project data are copied to the GOT

If OS or project data is copied to the GOT using the SD card or USB memory created with GOT data package acquisition, the utility setting is also copied.

Check each utility setting after copying to the GOT and change the setting according to need.

(c) SD card or USB memory to be used

When performing GOT data package acquisition, do not store other data to the SD card or USB memory.
If doing so, the previous data will be unavailable.

14. GOT SELF CHECK (DEBUG AND SELF CHECK)

The GOT can display the screen for debugging and self-checking.
The following describes the functions available as the debugging and self checking functions.

Item	Description	Reference
Debug	System monitor, A list editor, FX list editor, Backup/restoration	14-1
Self check	Memory check, Display check, Touch panel check, I/O check, Ethernet status check	14-3
System alarm display	GOT error, CPU error	14-19
GOT start time	GOT start time	14-21

14.1 Debug

In this manual, the overview of the debugging function is described.
For display contents and operation procedure of debugging, refer to the following manual.

 GOT1000 Series Extended/Option Functions Manual for GT Works3

The following describes the functions available as the debugging function.

Item	Description	Reference
System monitor	The device of PLC CPU and buffer memory of intelligent function module can be monitored or tested.	14-1
A list editor	The sequence program of ACPUCPU can be list edited.	14-1
FX list editor	The sequence program of FXCPU can be list edited.	14-1
Backup/restoration	Data can be backed up/restored from the controller to GOT, or backup data can be deleted.	14-2

14.1.1 System monitor

System monitor allows monitoring and changing the devices in controllers.
For display contents and operation procedure, refer to the following manual.

 GOT1000 Series Extended/Option Functions Manual for GT Works3

14.1.2 A list editor

MELSEC-A list editor allows changing the sequence programs in ACPUCPU/QCPU (A mode).
For display contents and operation procedure, refer to the following manual.

 GOT1000 Series Extended/Option Functions Manual for GT Works3

14.1.3 FX list editor

FX list editor allows changing the sequence programs in an FX PLC.
For display contents and operation procedure, refer to the following manual.

 GOT1000 Series Extended/Option Functions Manual for GT Works3

14.1.4 Backup/restoration

■ Display operation of Backup/restoration

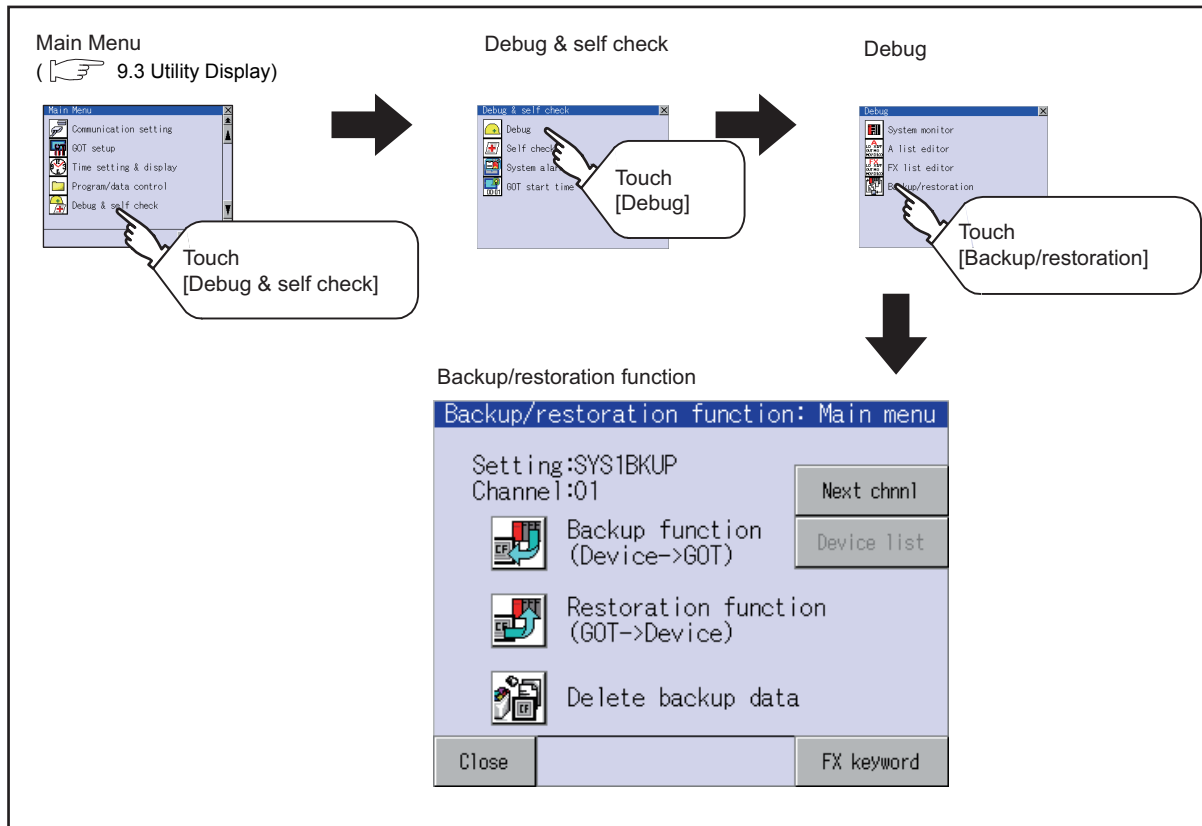

■ Operation of Backup/restoration

Backup/restore data from the controller to GOT, or delete backup data with the backup/restoration.

GOT data package acquisition is also possible.

For details of backup/restoration, refer to the following manuals.

 GOT1000 Series Extended/Option Functions Manual for GT Works3

14.2 Self Check

The following describes the functions available as the self check function.

Item	Description	Reference
Memory check	Carries out write/read check of the SD card, USB memory, built-in flash memory, or internal SRAM. [Password] 5920	14-3
Drawing check	Carries out missing bit check, color check and drawing check.	14-6
Font check	Displays the character data on the screen to check visually.	14-10
Touch panel check	Checks whether there are no dead zone area in the Touch key minimum unit (2 dots × 2 dots).	14-12
I/O check	Carries out RS-232, RS-422/485 connecting target confirmation and self-loopback check.	14-14
Ethernet status check	Sends a ping to check the Ethernet connection status.	14-17

14.2.1 Memory check

■ Memory check function

Memory check function carries out the write/read check of A drive (Built-in SD Card), C drive (Flash Memory), D drive (Internal SRAM) and E drive (USB memory).

Function	Description
A drive memory check	Checks whether the memory (Built-in SD card) of the A drive can be read/written normally.
C drive memory check	Checks whether the memory (Flash Memory) of the C drive can be read/written normally.
D drive memory check	Checks whether the memory (Internal SRAM) of the D drive can be read/written normally.
E drive memory check	Checks whether the memory (USB memory) of the E drive can be read/written normally.

■ Display operation of Memory check

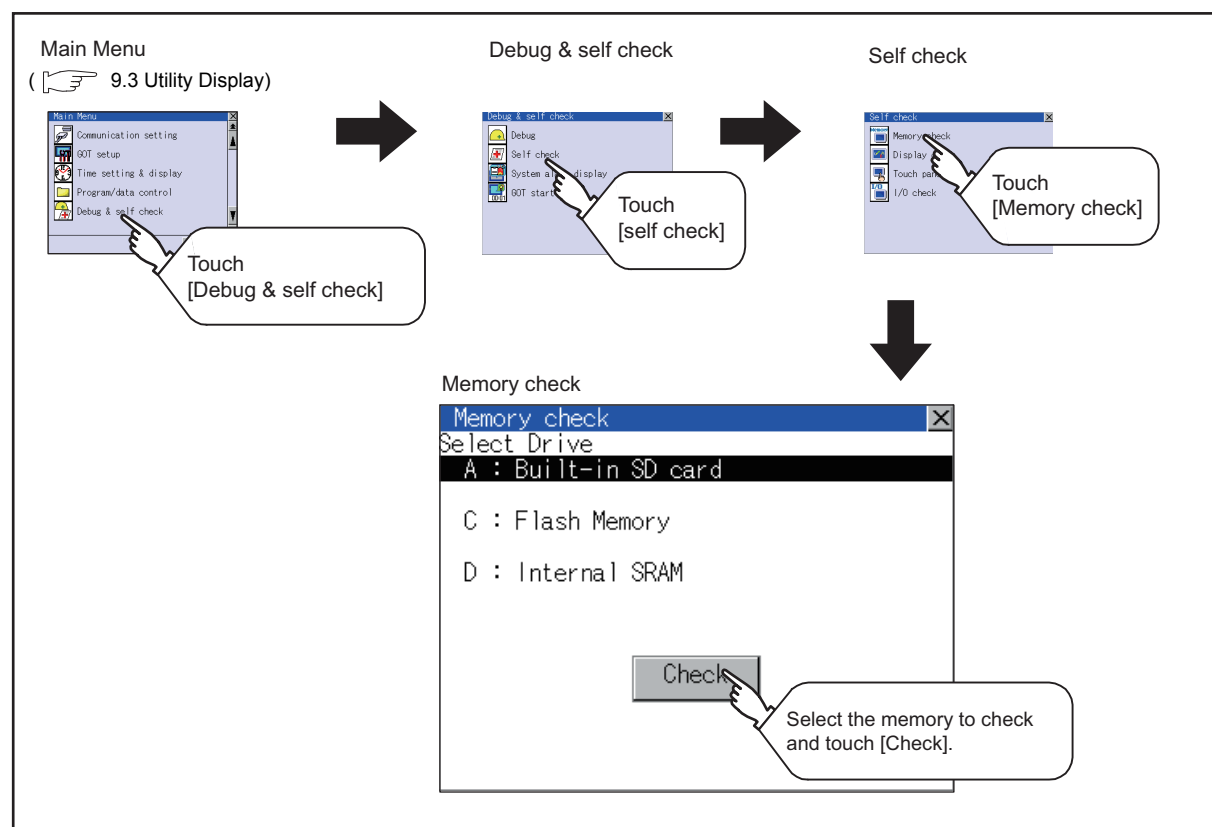

Memory check operation

Carries out write/read check of memory.

POINT

When drive is not displayed

When the drive (memory) to check is not displayed, confirm the mounting procedure or memory type with reference to the following.

- ☞ 8.1 SD Card
- 8.2 USB Memory

When no faults are found in mounting, etc, a memory failure may be arisen.

Replace the SD card or USB memory or built-in flash memory (C drive).

For details of built-in flash memory, contact your local Mitsubishi (Electric System) Service.

The following example explains about Memory Check using built-in flash memory (C drive).

For the Built-in SD card (A drive) memory check, install the SD card before carrying out the same key operations as built-in flash memory. For the USB drive (E drive) memory check, install the USB memory before carrying out the check operations.

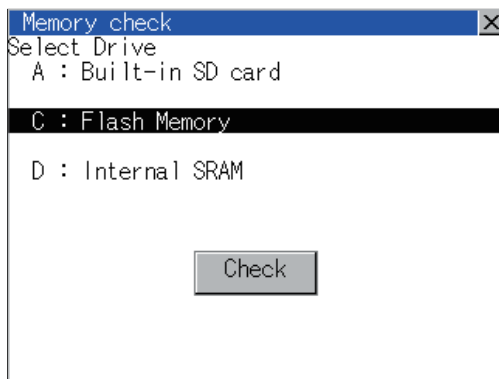

1. Select a drive to check in the Select Drive screen in Memory check and touch [Check] button.

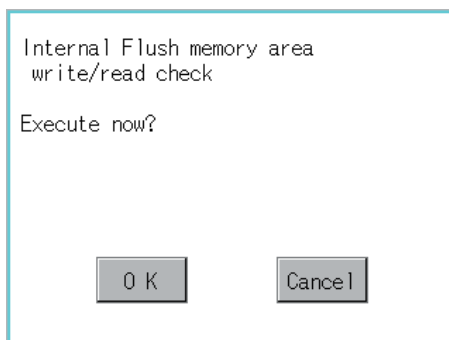

2. Touching [Check] button displays the dialog box on the left. Selecting [OK] button displays the numeric keyboard window. Selecting [Cancel] button returns to the initial menu.

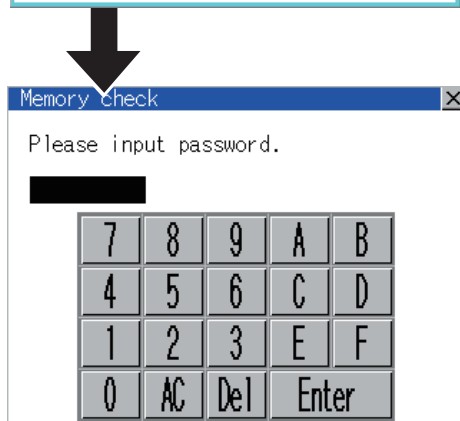

3. Touch to input password (**5 9 2 0**) and touch [Enter] key. Touching [Enter] key executes read/write check for the built-in flash memory, which is completed in around 10 seconds.

POINT

- (1) Password change
The password cannot be changed.
When input password error, the cancel dialog box is displayed.
Touching [OK] returns to the Memory check screen.

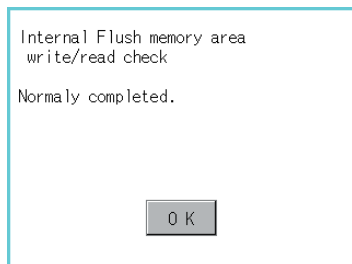
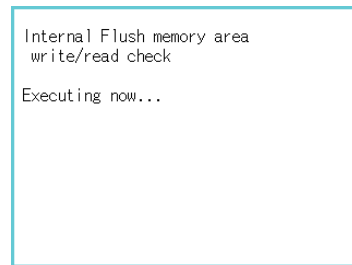
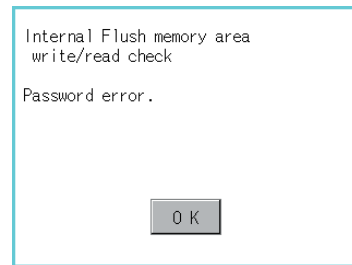

- (2) When error is found in memory
When error is found by memory check, the dialog box indicating the area in which the error occurred is displayed.
In case of error, contact your local Mitsubishi (Electric System) Service.
Touching [OK] returns to the Memory check screen.

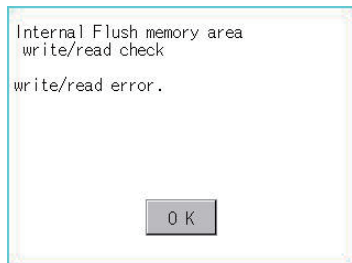

14.2.2 Drawing check

■ Drawing check function

The drawing check function carries out display checks as missing bit check, color check, basic figure display check, move check among screens.

■ Display operation of drawing check

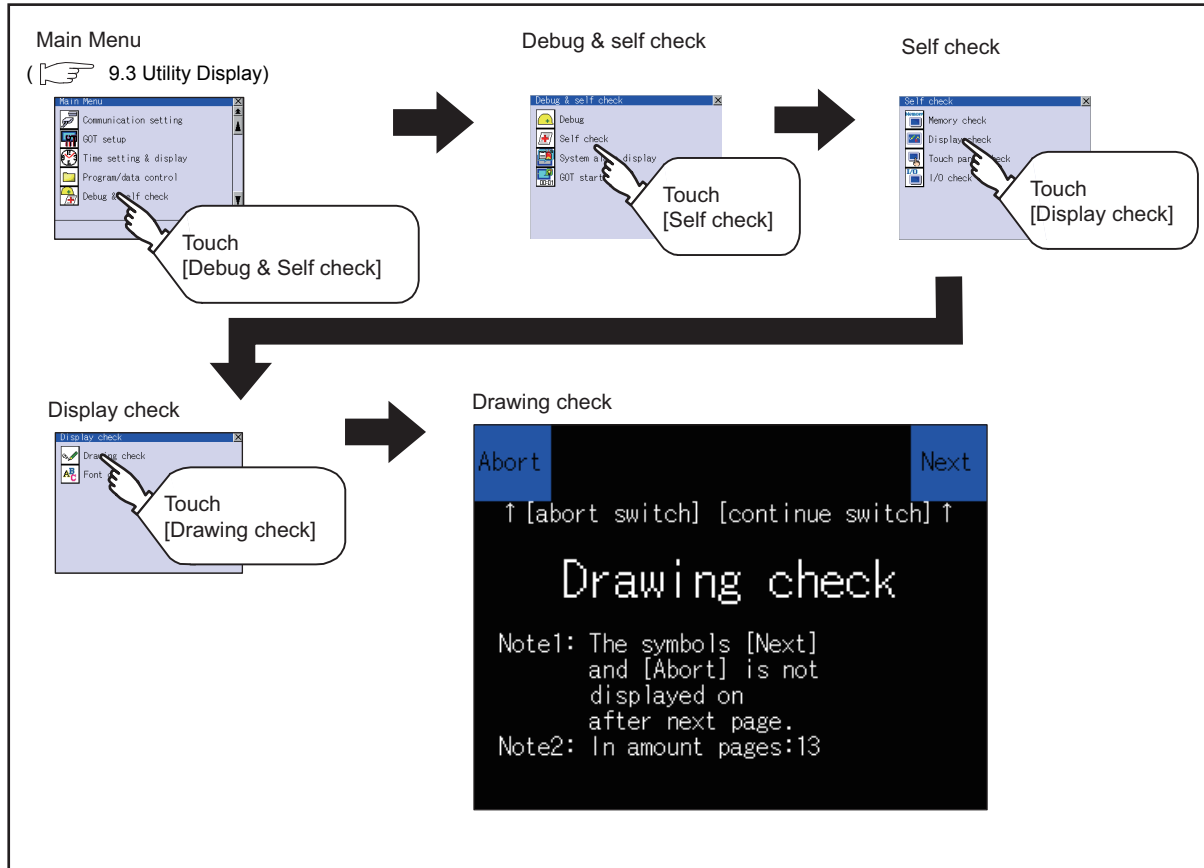

POINT

Notes on drawing check

Missing bits is occurred in the following cases.

- There are parts drawn in different color with the filled color.
- There are parts of basic figure and drawing patterns which are not drawn according to the layout and procedures described in "  14.2.2 ■ Display operation of drawing check".

When missing bits occurs, contact your local Mitsubishi (Electric System) Service.

■ Drawing check operation

The screen for drawing check can be displayed by touching [Drawing check] on the Display check menu.

(1) Before execute drawing check

Touching the upper right part of the screen proceeds to the next check in each step during drawing check.

Touching the upper left part of the screen returns to the [Display check] screen.

For GT1455-Q (65536 colors), the screen is displayed in color (blue, black, red, purple, green, light blue, yellow and white).

Also, for GT1450-Q (monochrome 16 scales), the screen color is reduced to monochrome 16 scales and displayed. This section explains in the case of GT1455-Q (65536 colors).

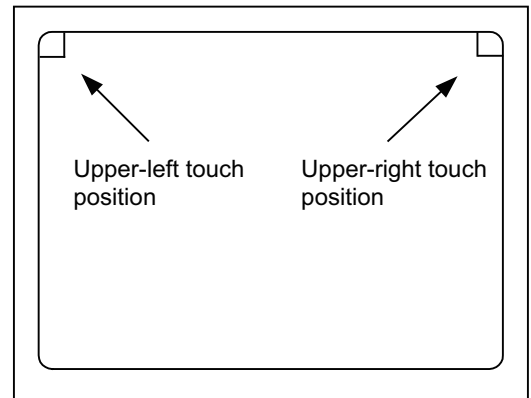

(a) Missing bit, Color Check

By touching the upper-right part of the screen, the entire screen color changes in the following order: blue → black → red → purple → green → light blue → yellow → white.

Check missing bit and color visually.

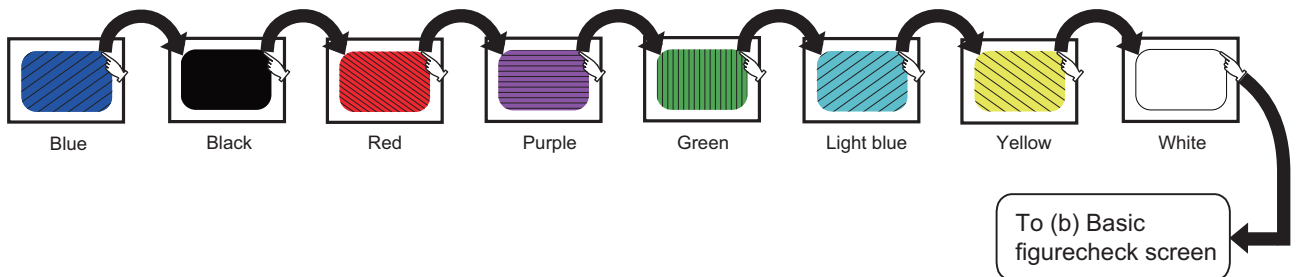

Touching the upper right part of the screen at the final color (white screen) displays the following (b) Basic figure check screen.

(b) Basic figure check

Check whether there is no shape transformation of basic figure or display losses.

The basic figure drawn has 4 types: 1. Filled circle, 2. Line, 3. Rectangle, 4. Ellipse.

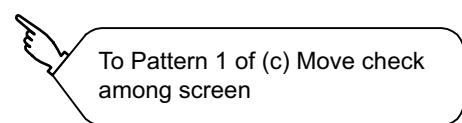
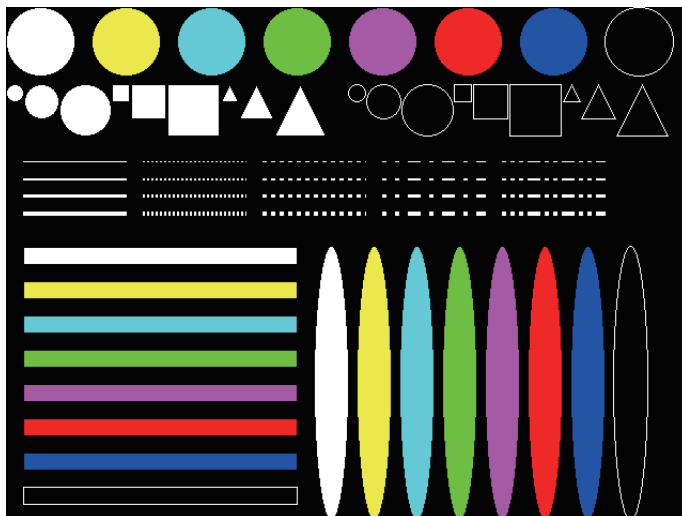

(c) Move check among screens

- Pattern 1: Shape transformation, color check

The drawn figures are displayed in order and at regular intervals.

If the shape and color are displayed visually in order, it is normal

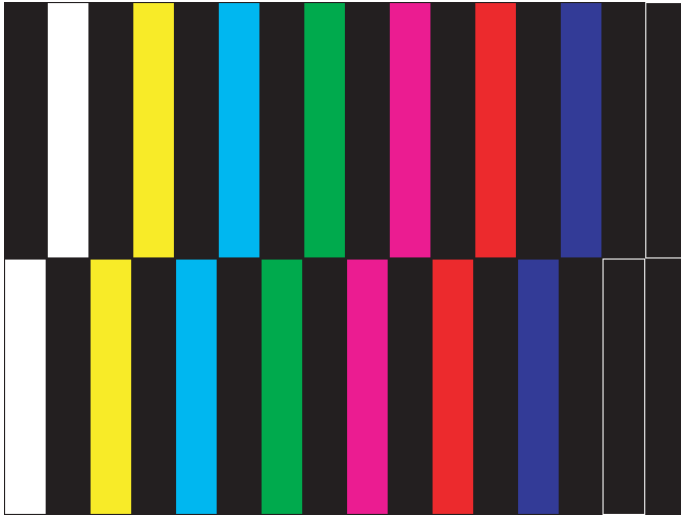

Pattern 1

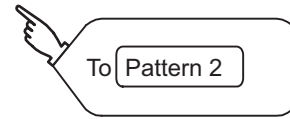

- Pattern 2: Shape transformation, color check

The drawn figures are displayed in order and at regular intervals.

If the shape and color are displayed visually in order, it is normal.

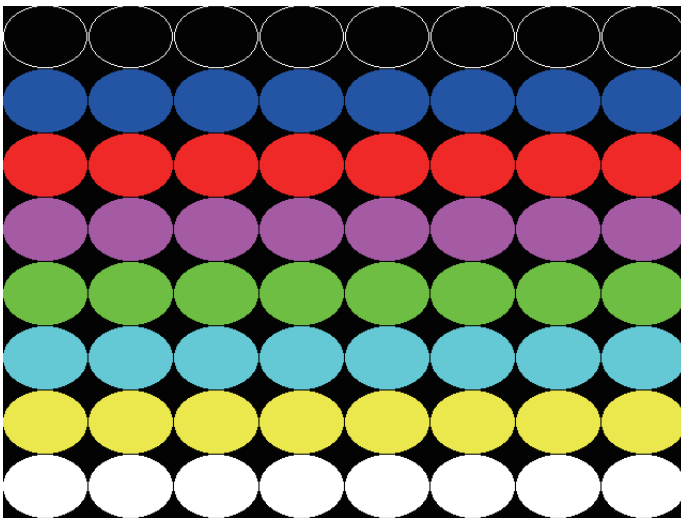

Pattern 2

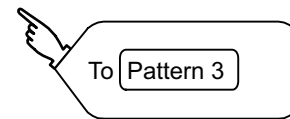

- Pattern 3: Shape transformation, color check
The overlapped shapes of pattern 1 and pattern 2 are displayed.
If the shape and color are displayed visually in order, it is normal.

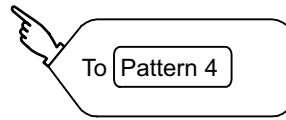
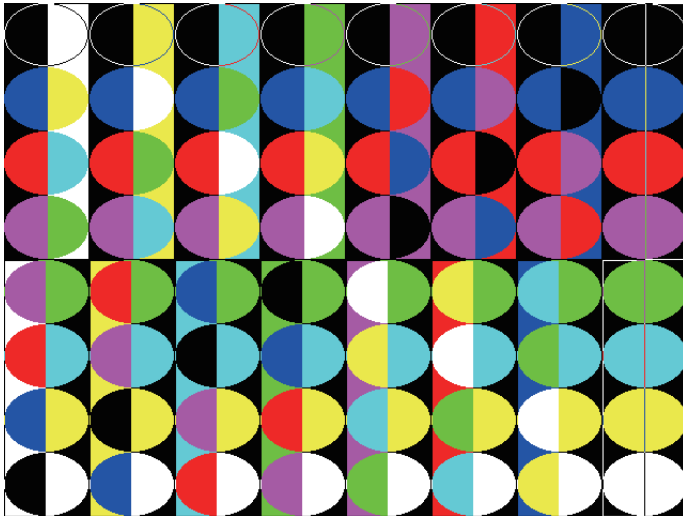

- Pattern 4: Shape check
The drawn figures are displayed in order and at regular intervals.
If the shape and interval are displayed visually in order, it is normal.
Touching the upper right part of the screen returns to the [Display check] screen.

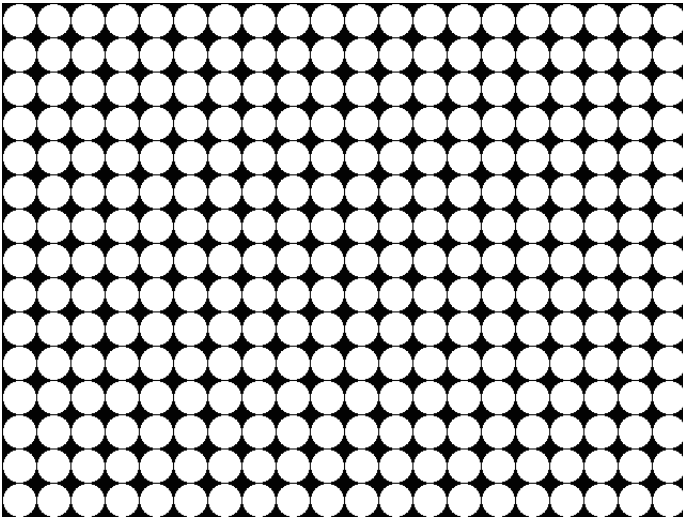

The main screen image after the screen information read and write is executed

14.2.3 Font check

■ Font check function

The font check is a function which confirms fonts installed in GOT. The character data of the font is displayed on the upper left part of the screen one by one.

■ Display operation of Font check

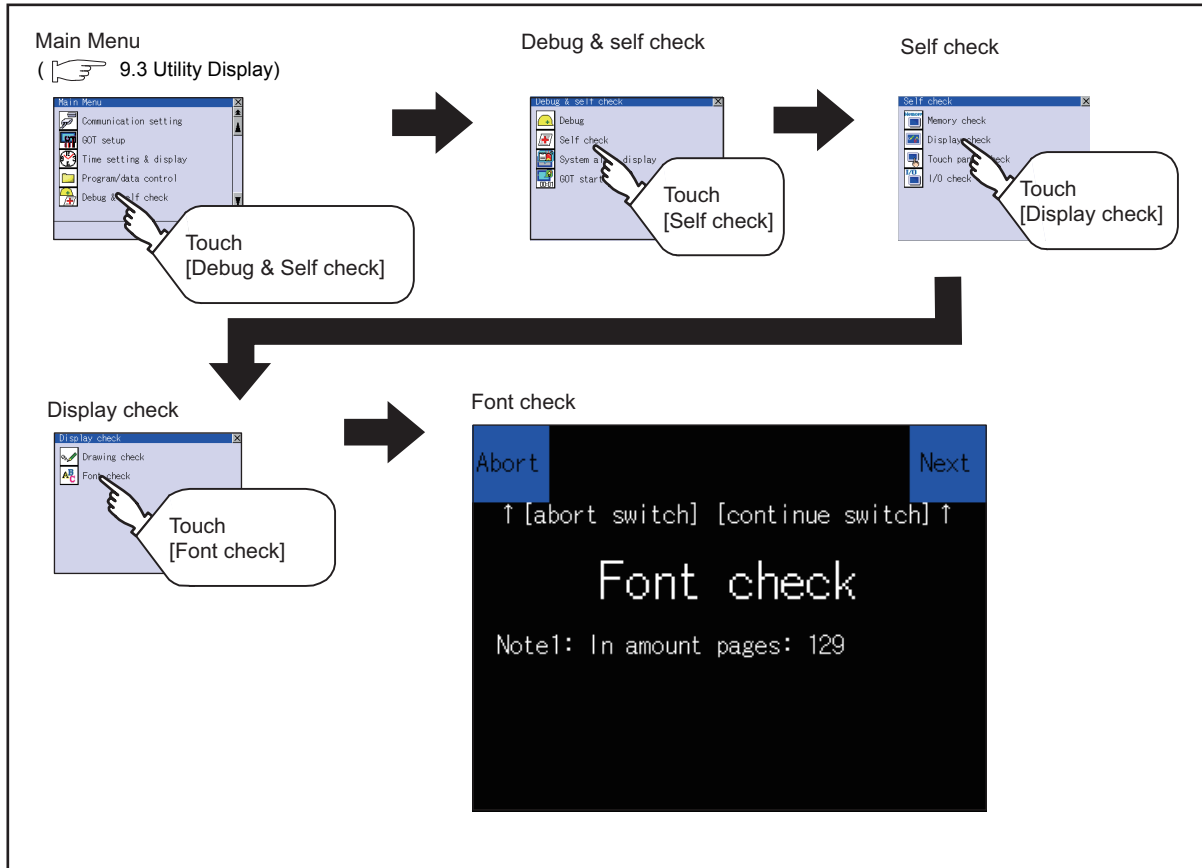

POINT

Notes on Font Check

Judged as normal if the following characters are correctly displayed. (UNICODE)

- Alphabetic characters etc. : 0x0000 to 0x04F9 (From basic Latin to Kirill)
- Hangul characters : 0xAC00 to 0xD7A3 (Hangul / Hangul auxiliary)
- Kanji : 0x4E00 to 0x9FA5 (CJK integrated Kanjis)

If the characters above are not displayed correctly, the fonts may not be installed. Install the standard monitor OS again.

■ Font check operation

Font check starts by touching [Font Check] in the [Display check] screen.

The character data of the built-in font (in the built-in flash memory) can be checked visually to confirm the font drawings by displaying the character data serially on the screen.

(1) Before execute font check

Touching the upper right part of the screen proceeds to the next check in each step during Font check.

Touching the upper left part of the screen returns to the [Display check] screen.

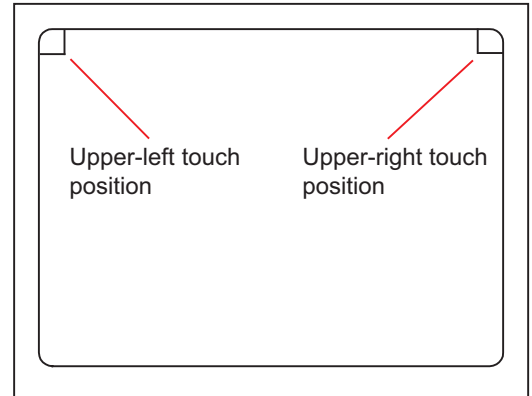

The installed font data is displayed by touching the upper right part of the screen.

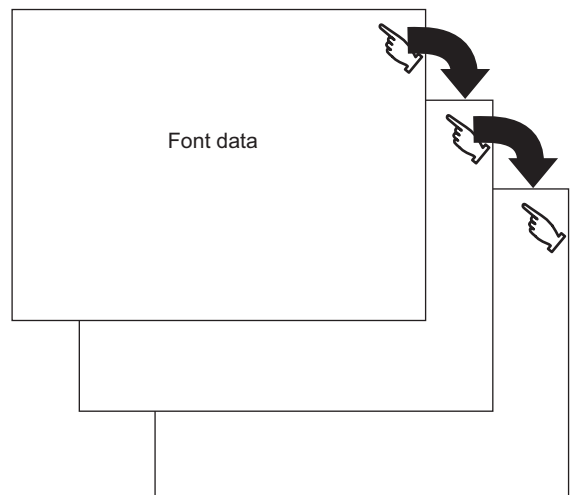

POINT

Option fonts

To display optional fonts, the option font installation is required.

The option fonts are displayed at the end.

14.2.4 Touch panel check

■ Touch panel check function

Touch panel check function checks whether there are no dead zone area in 2 dots × 2 dots.

■ Display operation of Touch panel check

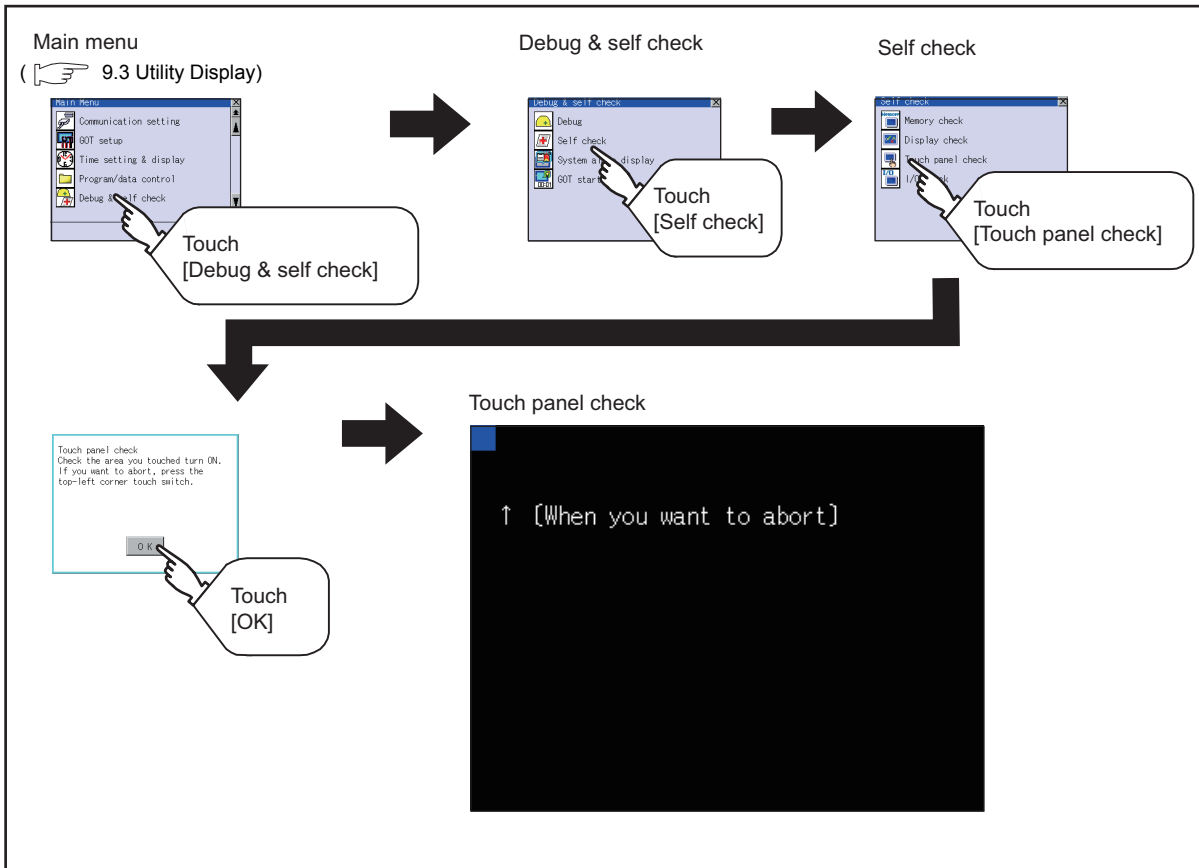

POINT

Notes on Touch panel check

If the touched part is not filled with yellow color, there are the following two possible causes.

1. Display part failure
2. Touch panel failure

In that case, contact your local Mitsubishi (Electric System) Service.

■ Touch panel check operations

Touching [Touch panel check] of self-check displays a black-filled screen over the entire screen area.

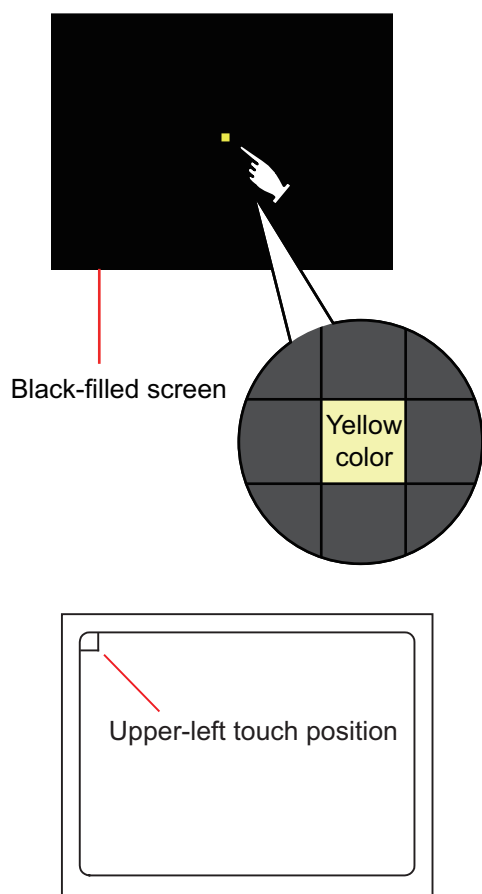

1. Touch a part of the screen.
The touched part becomes a yellow-filled display.

2. Touching the upper left part returns to the self-check.

POINT

Checking the upper left part of the screen

Only the upper left part of the screen cannot be filled with yellow.

If returns to the self-check by touching the upper left part, judge that the upper left area operates normally.

14.2.5 I/O check

■ I/O check function

The I/O check is a function which checks whether GOT and PLC can communicate with each other. If I/O check ends normally, the communication interface and the connection cable hardware are normal. To execute I/O check, the communication driver has to be installed in GOT in advance from GT Designer3. Note that the GOT restarts when this function is performed. For the details related to the installation of the communication driver, refer to the following.

 GT Designer3 Version1 Screen Design Manual (Fundamentals)

(1) Communication drivers inapplicable to I/O check

When the following communication drivers are used, the I/O check cannot be executed.

Connection type		Communication driver
Connection to MITSUBISHI PLC	Ethernet connection	Ethernet(MELSEC), Q17nNC, CRnD-700
Connection to YASKAWA PLC		YASKAWA GL/CP9200(SH/H)/CP9300MS, Ethernet (YASKAWA)
Connection to YOKOGAWA PLC		YOKOGAWA FA500/FA-M3/STARDOM, Ethernet (YOKOGAWA)
Connection to ALLEN-BRADLEY PLC		EtherNet/IP(AB)
Connection to SIEMENS PLC		SIEMENS S7, SIEMENS S7-200, SIEMENS S7-300/400
Microcomputer connection		Computer
Inverter connection		FREQROL 500/700
MODBUS(R)/TCP connection		MODBUS/TCP
Connection to Azbil control equipment		Azbil SDC/DMC
Connection to RKC temperature controller		RKC SR Mini HG (MODBUS)

■ Display operation of I/O Check

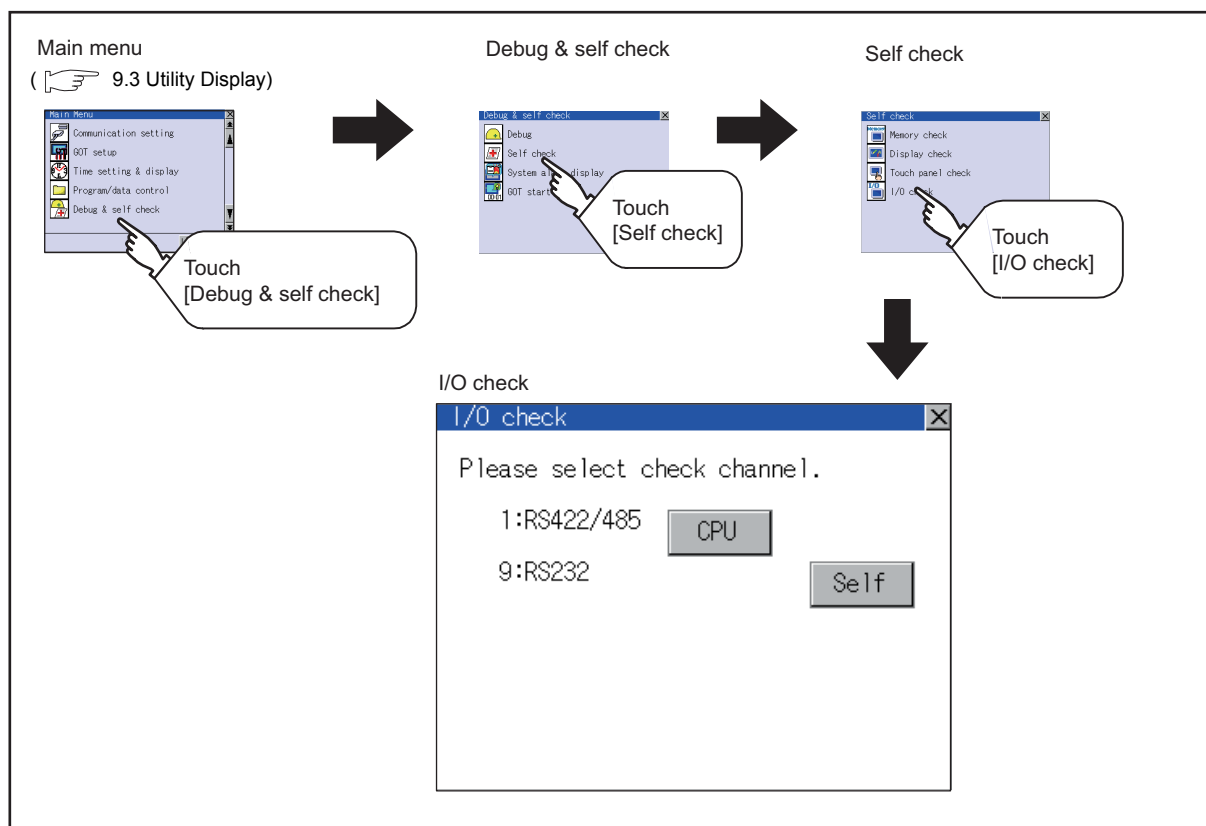

■ I/O check operation

(1) Connecting target confirmation

Touching [CPU] button carries out the connecting target confirmation communication check.



1. After the CPU communication starts normally, the dialog box mentioned left notifying that it is on checking, until the connecting target confirmation communication ends normally.

2. When the connecting target confirmation communication ends, its result is notified by dialog box. If the connecting target confirmation communication ends normally, the dialog box notifying of the normal termination mentioned left is displayed. Touching [OK] button after confirming the result returns to [I/O check].

If the dialog box mentioned left is displayed after selecting connecting target confirmation or during CPU communication check, confirm the following.

- No misconnection with CPU
(☞ GOT1000 Series Connection Manual for GT Works3)
- No missettings of parameter
(☞ 10.2 Communication Detail Setting)
- No hardware error.
(☞ 18. TROUBLESHOOTING)

Touching [OK] button after confirming the result returns to [I/O check].

(2) Self-loopback

Touching [Self] carries out the hardware check of RS-232 interface.

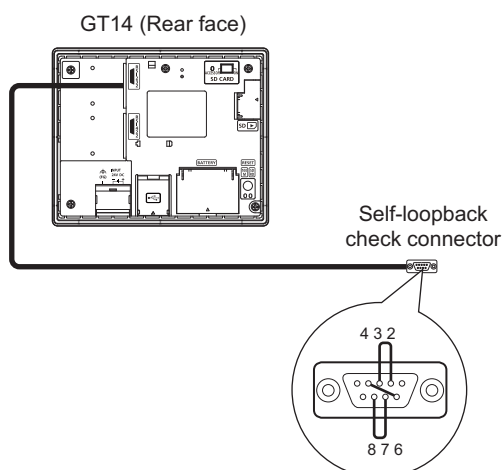

1. For preparation for the self-loopback communication check, insert the connector for self-loopback check (Customer purchased) shown in the diagram left in the RS-232 interface. For this connector, short 2 and 3 pins, 7 and 8 pins and 4 and 6 pins, respectively.

In the communication setting of the GOT utility, set the channel number for the RS-232 interface to 0 ([None]).

```
RS232 communication check
Error
The following cause:
Connection error, H/W error,
parameter setting error.
Restart
```

```
RS232 communication check
Executing now
```

```
RS232 communication check
No error
Restart
```

```
RS232 communication check
Error
Verify 4 BYTE
Restart
```

2. After selecting [Self], the transferred data and received data are verified through the self-loopback connector. When the GOT cannot receive the data during the data transmission, the dialog box shown left appears and the GOT restarts in five seconds. When the dialog box shown left appears, check the following.

- Check if the pins of the connector for self-loopback check are incorrectly shorted.
- Check if the channel number for the RS-232 interface is set to 0 ([None]) in the communication setting of the GOT utility.

(☞ 10.1.3 Communication setting contents)

- Check if the hardware has no problems.

(☞ 18. TROUBLESHOOTING)

3. During check, the dialog box shown left is displayed.

4. When the all checks ended normally, the dialog box shown left is displayed. And the GOT restarts in five seconds.

5. When an error occurs, the dialog box that shows the GOT abnormal termination and the byte with the error appears, and then the GOT restarts in five seconds.

When the dialog box shown left appears, check the following.

- Check if the hardware has no problems.

(☞ 18. TROUBLESHOOTING)

14.2.6 Ethernet status check

■ Ethernet status check function

Ethernet status check is a function that sends a ping to check the connection status with the equipment on the Ethernet.

■ Display operation of Ethernet status check

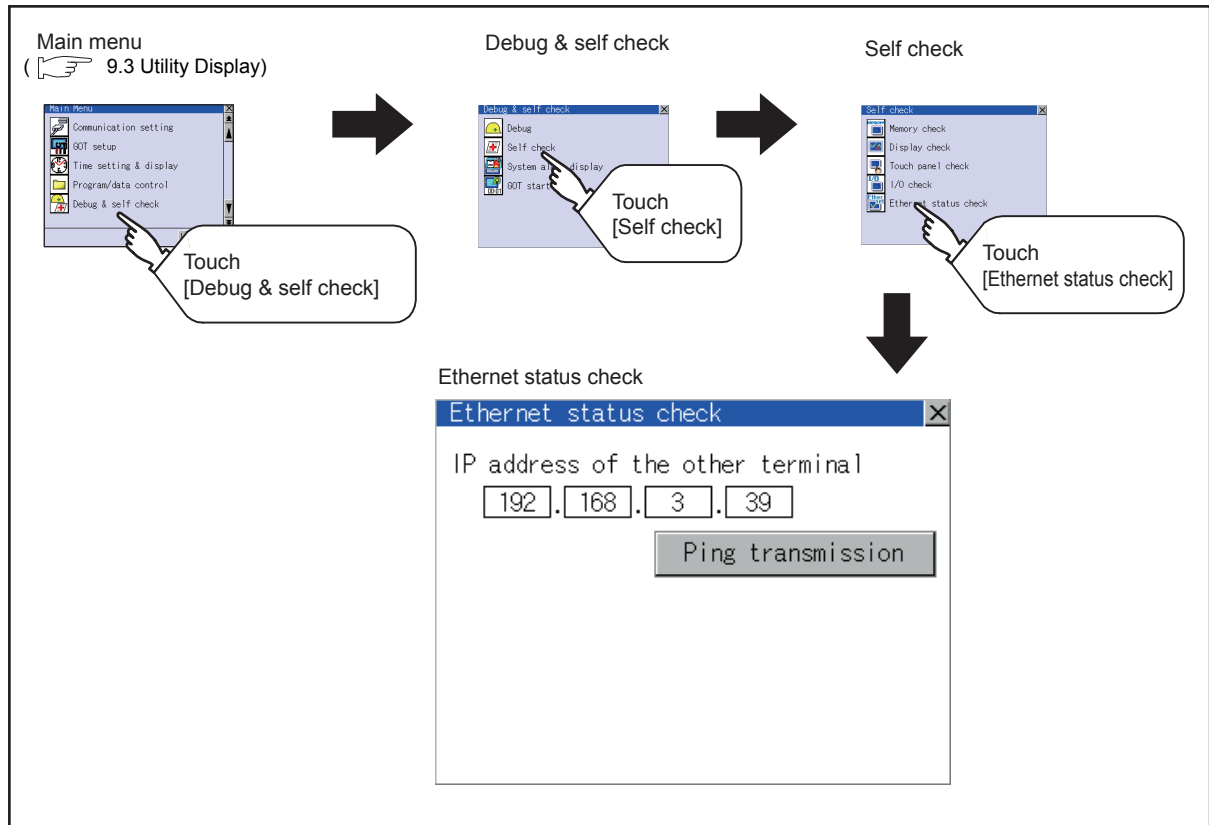

■ Operation of Ethernet status check

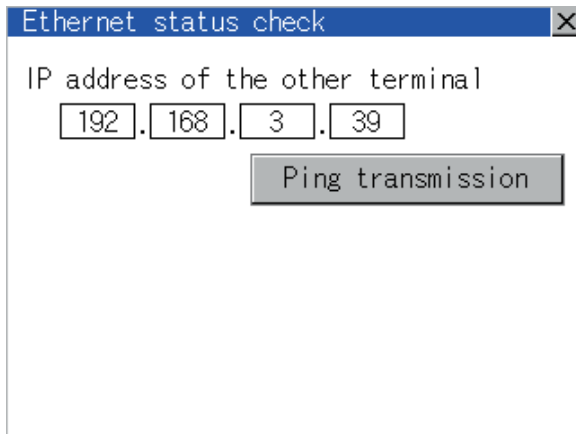

1. If touch the select button of [IP address of the other terminal], a keyboard is displayed. Enter the IP address of the other terminal with the keyboard. <Default: 192.168.3.39>

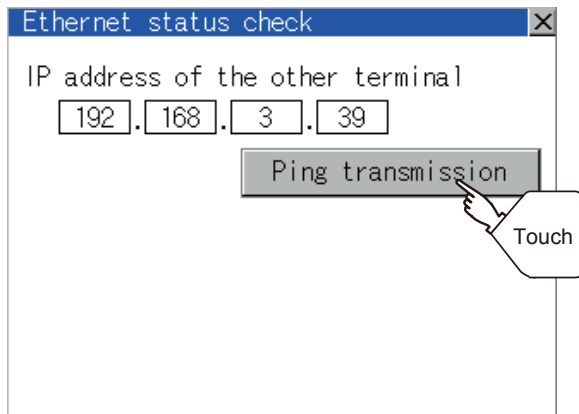

2. If touch the [Ping transmission] button, a ping is sent to the IP address entered in [IP address of the other station]. The timeout time is about 5sec.
 - When GOT and PLC are in communication
The dialog box showing [Response received.] is displayed.
 - When a communication error occurs
The dialog box showing [Timeout occurred.] is displayed.

14.3 System Alarm Display

■ System alarm function

System alarm is the function to display error code and error message when an error occurs in GOT, controller or network.

System alarms can be reset on the System alarm display screen.

For details of system alarm, refer to the following manual.

☞ GT Designer3 Version1 Screen Design Manual (Fundamentals)

■ Display operation of System alarm display

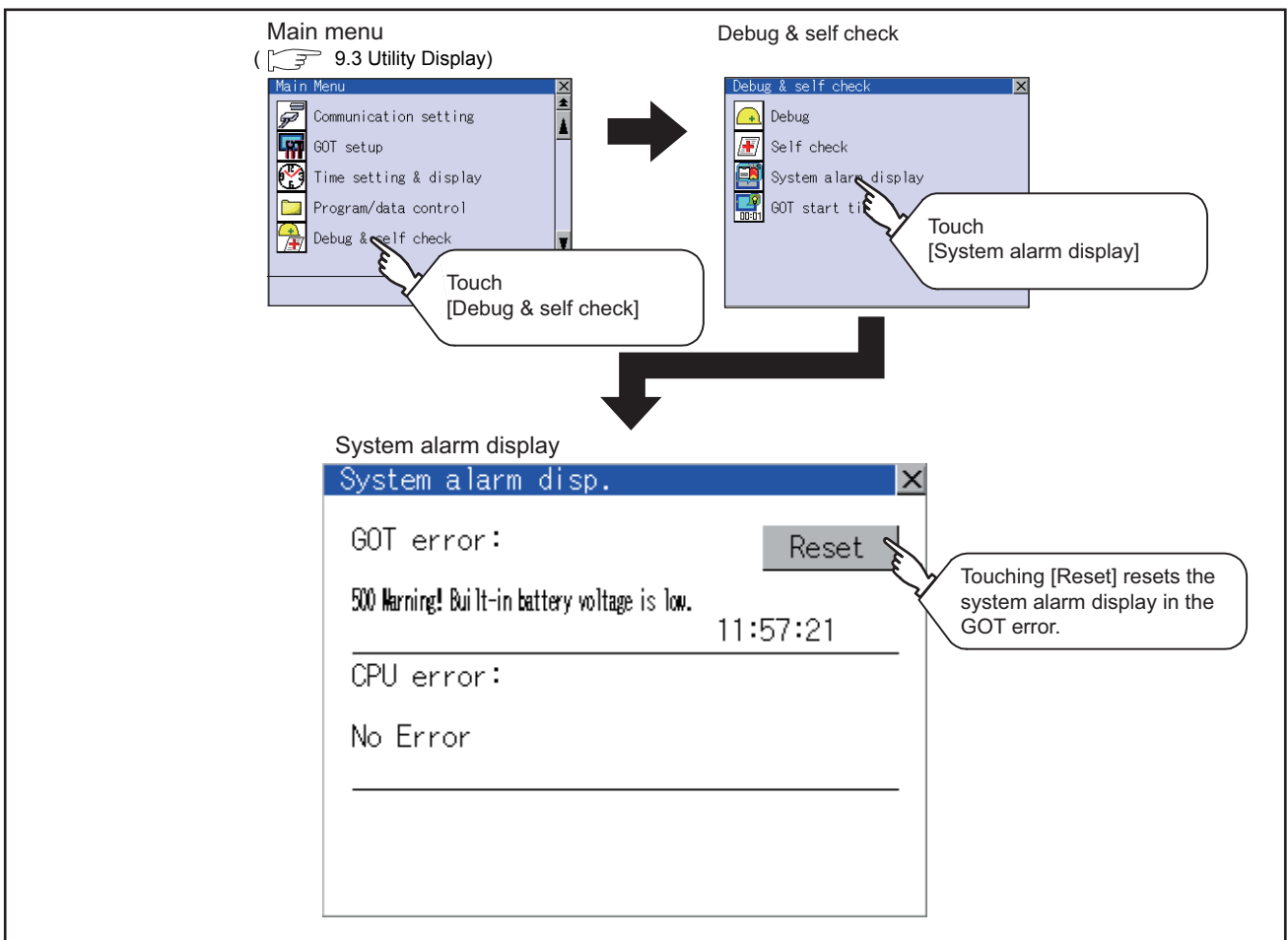

■ Operation of system alarm display

(1) System alarm display resetting

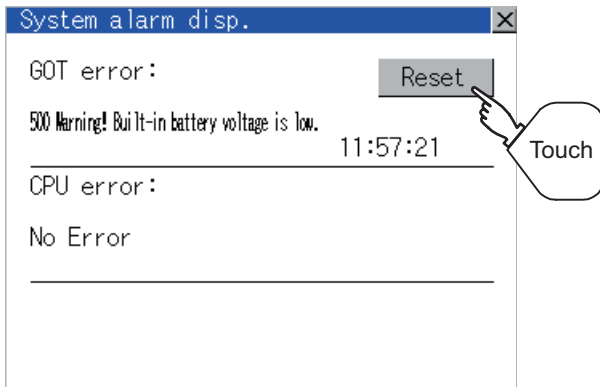
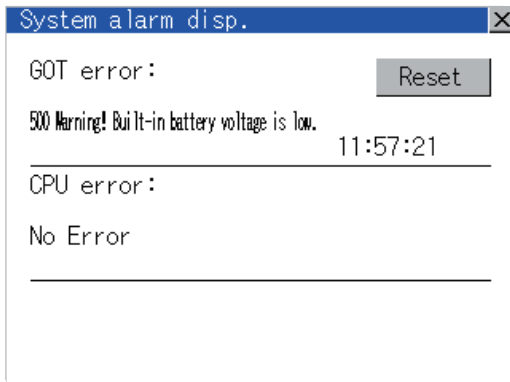

1. Eliminate each cause of the system alarm being occurred.
Error causes can be identified by the error code, error message and channel No. displayed on the System alarm screen.
(☞ 18. TROUBLESHOOTING)

2. A method for resetting system alarm depends on an error.
 - GOT error
Touch [Reset] button to reset system alarms.
 - CPU and Network error
The system alarm is automatically reset after its cause is eliminated.

POINT

- (1) Before resetting the system alarm display in the GOT error
Eliminate the system alarm cause before resetting the system alarm display in the GOT error.
If not eliminated, the system alarm display in the GOT error will not be reset even after the reset operation.
- (2) Processings with reset operation
The following data in the system information are also reset.
 - GOT error code (Write device)
 - GOT error detection signal (System Signal 2-1.b13)

14.4 GOT start time

■ GOT start time function

GOT start time is the function to display the following date and time.

- Start time of GOT
- Current time of GOT
- Operating hours of GOT

■ Display operation of GOT start time

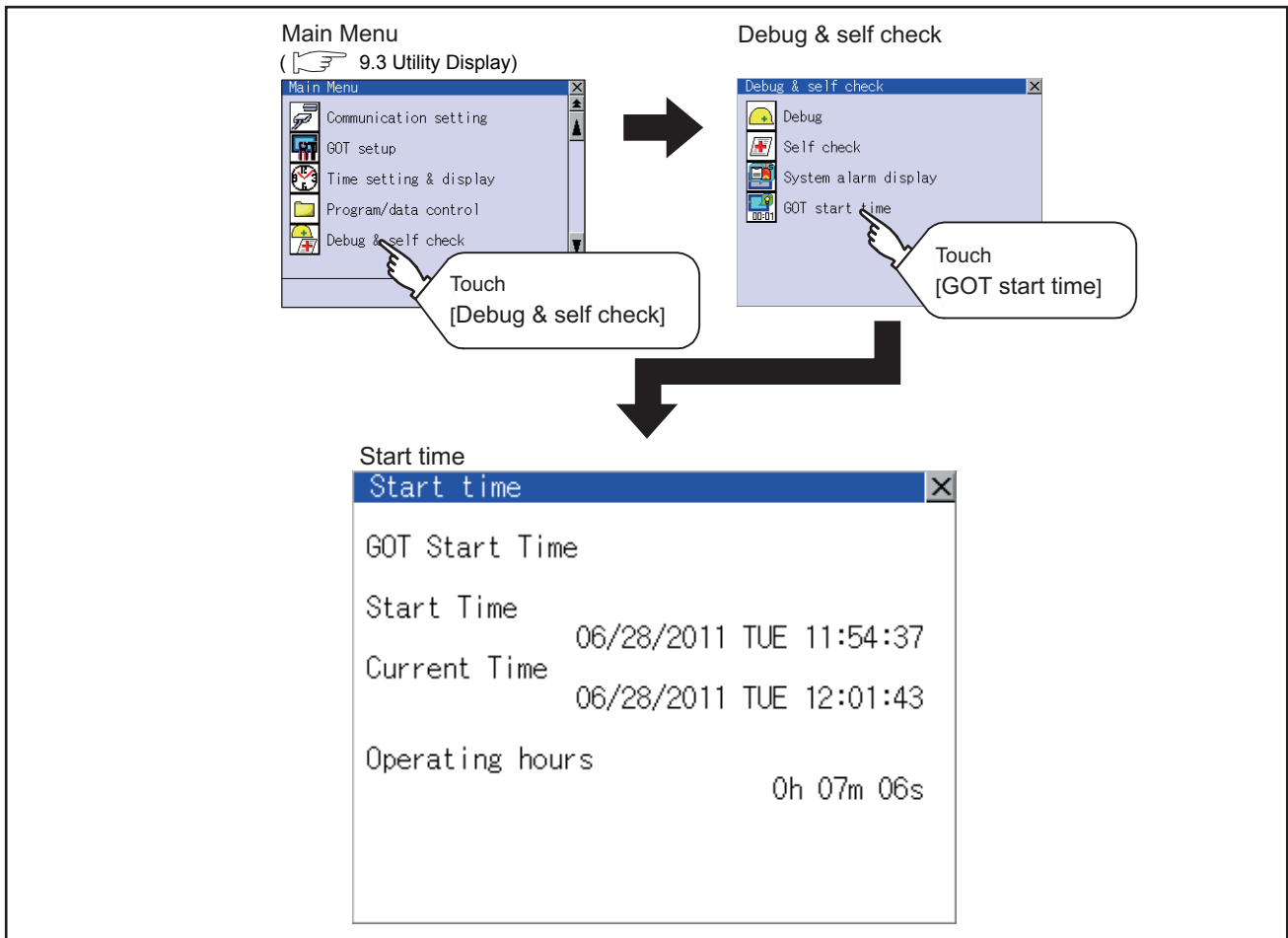

■ Display of GOT start time

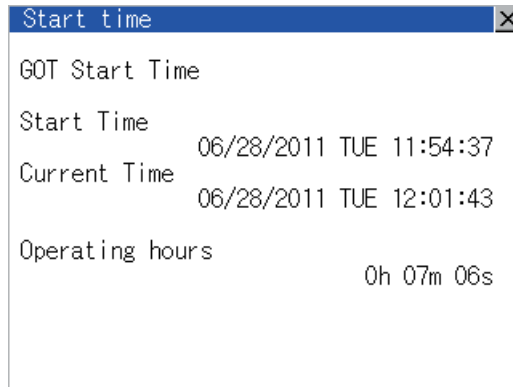

Item	Description
Start Time	Displays the time when the GOT was powered on or reset-restarted (OS installation, communication setting change).
Current Time	Displays the current time.
Operating hours	Displays operating hours of the GOT. The displayed operating hours is the accumulated time while GOT is powered on or reset-restarted (OS installation, communication setting change). When powering off or reset-restarting the GOT, the operating hours is cleared.

POINT

- (1) To display correct time
Set the clock of GOT. (☞ 12.1.1 Time setting and display functions)
When the clock has not been set, the correct time is not displayed at [Start Time] and [Current Time].
- (2) Time displayed at [Operating hours]
[Operating hours] is displayed irrespective of [Start Time] and [Current Time].
When changing the clock of the GOT, [Operating hours] does not match with the difference between [Current Time] and [Start Time].
([Operating hours] is not the time calculated from [Current Time] and [Start Time].)
The time displayed at [Operating hours] is a reference for the accumulated time while GOT is powered on or reset-restarted (OS installation, communication setting change).

15. CLEANING DISPLAY SECTION (CLEAN)

In utility, the screen can be set as not to be effected by touching the screen when clean with clothes. To clean the GOT, wipe the dirty part with a soft cloth using neutral detergent.

POINT

Precautions for cleaning

Do not use chemicals such as thinner, organic solvents and strong acids, since they may cause the protective sheet to be deformed or the dissolvable paint on the surface to peel off.

In addition, do not use spray solvents since they may cause the electrical failure of the GOT and peripheral devices.

■ Display operation of Clean

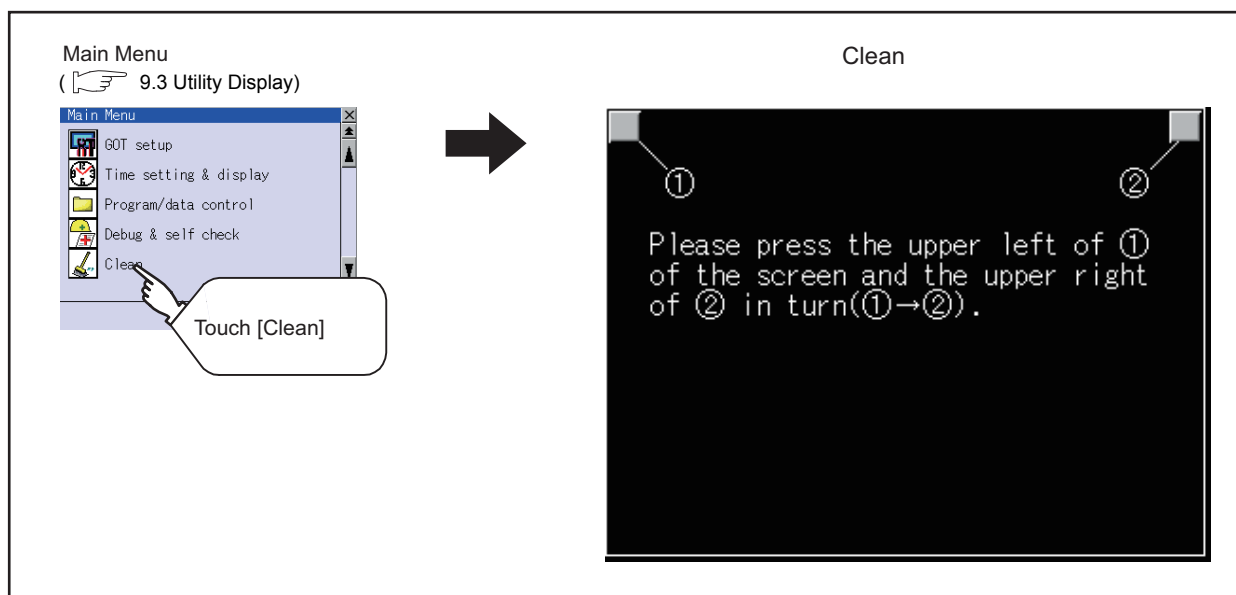

Even if touch points other than the upper left corner and upper right corner of the screen, the GOT does not operate.

■ Operation of Clean

After cleaning the screen, touch the screen following the instruction displayed.

After touching the screen, the screen returns to the Main Menu.

The following screen is displayed.

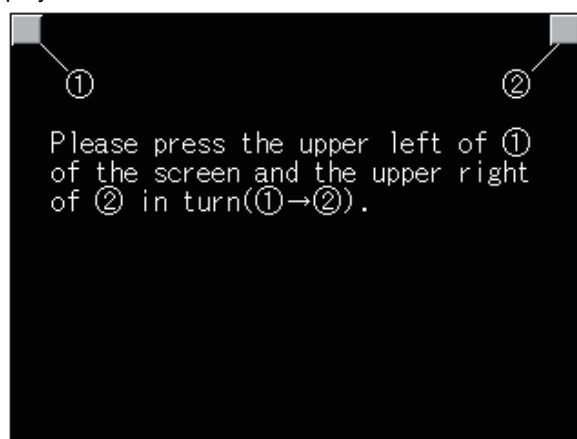

16. INSTALLATION OF COREOS, BOOTOS AND STANDARD MONITOR OS

For executing the GOT utility, install the BootOS and standard monitor OS on the C drive (built-in flash memory) of the GOT, or set the OS boot drive to [A: Standard SD card] and insert the SD card with OS files into the GOT. (BootOS is installed in the GOT at factory shipment. It is not necessary to install BootOS when upgrading of it is unnecessary.)

This chapter explains the installation using GOT.

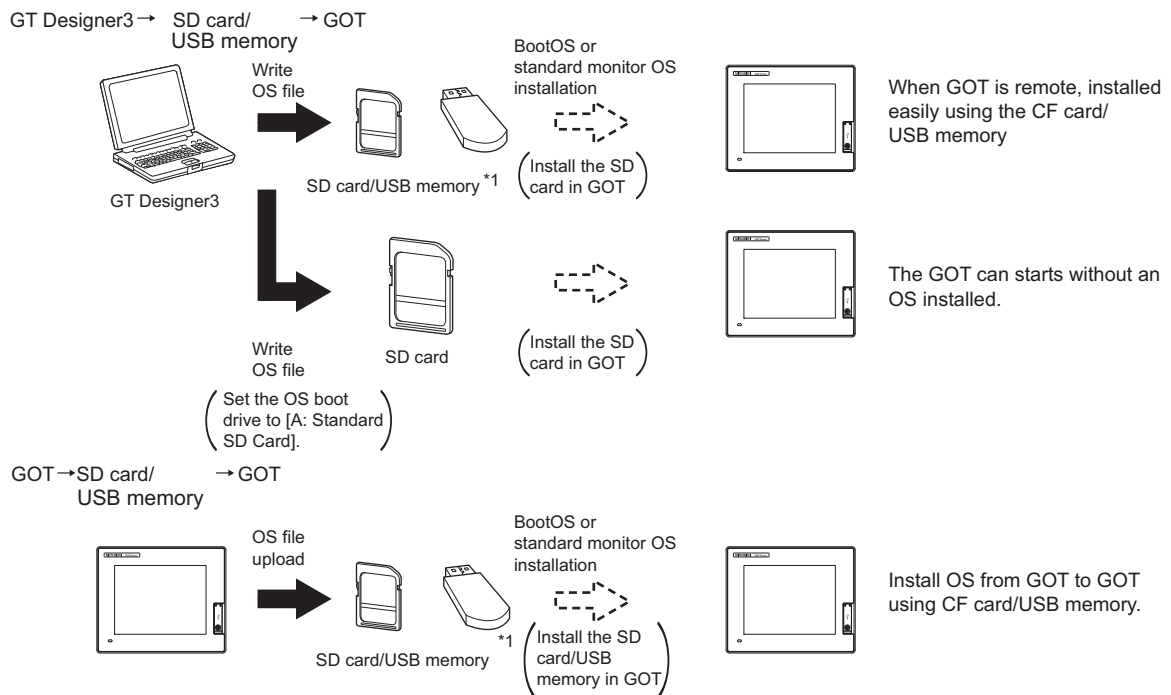

*1 When execute installation with USB memory, standard monitor OS has to be installed in GOT in advance.

For the writing of OS in GT Designer3, refer to the following.

👉 GT Designer3 Version1 Screen Design Manual (Fundamentals)

POINT

CoreOS

In 16.1 to 16.4 of this chapter, only BootOS and standard monitor OS are described.

For CoreOS, refer to the following.

👉 16.5 CoreOS

16.1 BootOS and Standard Monitor OS Required for Installation

Under-mentioned BootOS and Standard monitor OS are necessary to execute utility.

OS name	Function overview		Storage location
BootOS	Required for the control of GOT and the communication between PC and GOT. Installed at factory shipment. (BootOS can be installed from GT Designer3 or the SD card. When installed from GT Designer3 or the SD card, GOT is initialized to be the factory shipment status.)		Built-in flash memory C: \G1BOOT\ SD card that stores data with OS boot drive set to the A drive A: \G1BOOT\
Standard monitor OS	Required for the GOT operation as the monitoring function of GOT, installation and deletion of the OS file or project data, touch key control or display function of the screen and guidance.	Required for display and operation of the user-created screen and utility screen. Not installed in GOT at factory shipment. Install it from GT Designer3, or the SD card or USB memory. At installation, select [Mincho] or [Gothic] for the 16-dot standard font.	Built-in flash memory C: \G1SYS\ SD card that stores data with OS boot drive set to the A drive A: \G1SYS\
	System screen data		
	System screen management information file		
	TrueType numerical font		
	12-dot standard font (Gothic)		
	16-dot standard font (Mincho)		
16-dot standard font (Gothic)			

16.2 Prior Preparations for Installing BootOS and Standard Monitor OS

For the installation using GOT, the SD card or USB memory storing BootOS or standard monitor OS is required. For the method of writing BootOS and standard monitor OS in the SD card or USB memory, the following three methods are available.

- (1) [To Memory Card] from GT Designer3

☞ GT Designer3 Version1 Screen Design Manual (Fundamentals)

- (2) Uploading from other GOT (BootOS or standard monitor OS has been installed)

☞ 13. FILE DISPLAY AND COPY (PROGRAM/DATA CONTROL)

- (3) Using SD card that stores data with OS boot drive set to A drive

☞ GT Designer3 Version1 Screen Design Manual (Fundamentals)

POINT

Precautions on writing BootOS, standard monitor OS in SD card or USB memory

When writing BootOS, standard monitor OS, etc. in the SD card or USB memory, be sure to execute by the utility of other GOT, GT Designer3.

The installation is not executed properly with the SD card or USB memory to which uploaded from the utility of GOT or copied by software other than GT Designer3.

Note the available capacity of the SD card or USB memory.

The available capacity of BootOS and standard monitor OS can be confirmed by [To Memory Card] of GT Designer3.

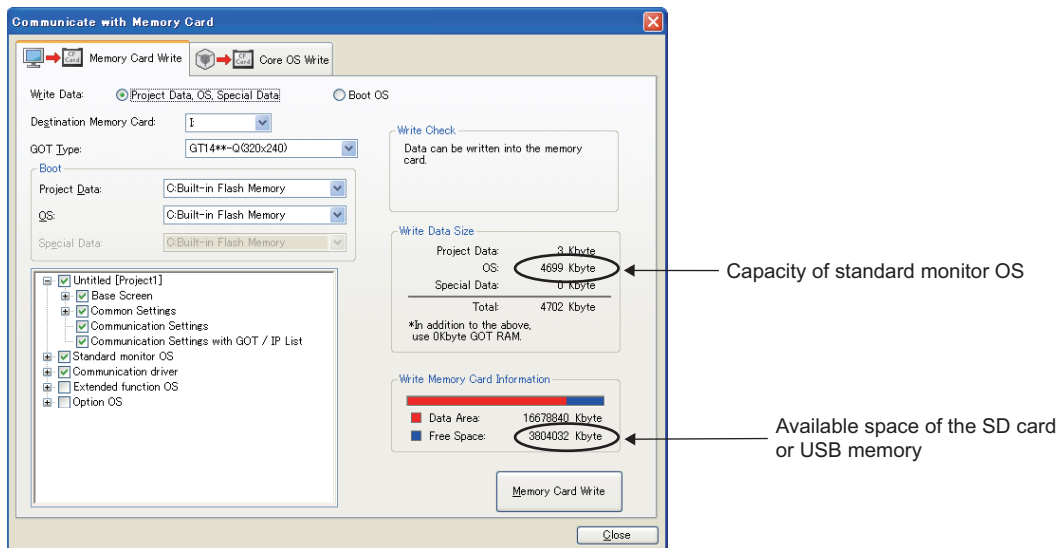

16.3 BootOS and Standard Monitor OS Installation Using SD card or USB Memory

There are the following two types for the BootOS, standard monitor OS installation using the SD card or USB memory.

(1) Installing when starting the GOT

 16.3.1 Installing when starting the GOT)

All the OS and project data stored in the SD card or USB memory are transferred to the GOT when powering on the GOT. This installing method is effective in the following cases.

- The GOT utility cannot be displayed.
- The standard monitor OS is not installed.

(2) Installing using the data control function (Utility)

 16.3.2 Installing using the program/data control function (Utility))

By operating the utility, select OS or project data stored in the SD card or USB memory and transfer them to the GOT.

POINT

Precautions on installing BootOS, standard monitor OS

(1) Installing both BootOS and standard monitor OS

After completing BootOS installation, install standard monitor OS. When installing BootOS, the built-in flash memory in the GOT is initialized and goes to the status at factory shipment. (All OS and project data are erased.)

BootOS is installed in the GOT at factory shipment.

It is not necessary to install BootOS when not upgrading it.

(2) Copying project data using SD card or USB memory

After installing BootOS, standard monitor OS, and other OS, download the project data.

At this time, match the version of the standard monitor OS in the GOT with the version of the standard monitor OS with which the project data was created.

(3) When OS and project data are in the SD card or USB memory (when using GT Designer3)

When installing by pressing the upper left corner of the GOT screen, project data is downloaded after completion of OS installation.

When installing with the utility, install the OS and download the project data from their respective operation screens.

(4) Installation cannot be interrupted.

Do not perform any of the following during a BootOS or standard monitor OS installation.

Failure to do so may result in installation failure, causing the GOT malfunction.

- Powering off the GOT
- Pressing the reset button of the GOT
- Turning off the SD card access switch of the GOT
- Removing the SD card or USB memory

If the installation failure and the GOT malfunction occur, take the following action.

- If BootOS installation failed: Install CoreOS.

 16.5.1 Installing the CoreOS)

- If standard monitor OS installation failed: Install BootOS.

 16.3.1 Installing when starting the GOT)

16.3.1 Installing when starting the GOT

The displayed message is different depending on the installation condition of standard monitor OS. When the screen requesting operation is displayed, operate the GOT according to the instructions on the screen.

■ Operation procedure

(1) When installing with SD card

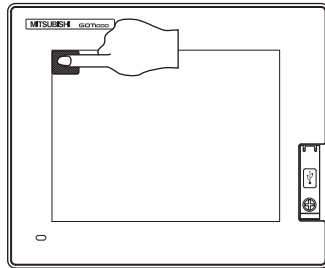

Now installing BootOS.

Reboot.

1. Power OFF the GOT, switch the SD card access switch to OFF, and install the SD card where the BootOS, standard monitor OS or project data is stored in the SD card interface of the GOT.
2. Switch ON the SD card access switch of GOT.
3. Power on the GOT while pressing upper left corner of the GOT screen. (1-point press installation function)
4. The BootOS or standard monitor OS is installed in the built-in flash memory.
The SD card access LED is lit during the install execution.
Do not pull out the SD card or power off the GOT while the SD card access LED is lit.
5. The GOT restarts automatically after the installation is completed.
(When the standard monitor OS is already installed, the GOT restarts by touching the [OK] button.)
6. After confirming normal restart, switch off the SD card access switch of the GOT. Confirm that the card access LED is not lit, and remove the SD card from the SD card interface of the GOT.

(2) When installing with USB memory

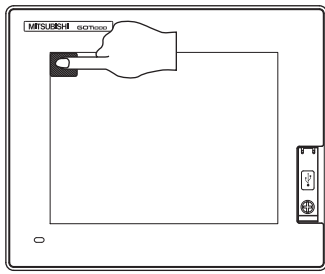

Now installing BootOS.

Reboot.

1. Power off the GOT, and install the USB memory where the BootOS, standard monitor OS or project data is stored in the USB interface of the GOT. The BootOS cannot be stored in the USB memory where the standard monitor OS or project data is stored.
2. Power on the GOT while pressing upper left corner of the GOT screen. (1-point press installation function)
3. The BootOS or standard monitor OS is installed in the built-in flash memory. Do not pull out the USB memory or power off the GOT while install execution.
4. The GOT restarts automatically after the installation is completed. (When the standard monitor OS is already installed, the GOT restarts by touching the [OK] button.)
5. After confirming normal restart, remove USB memory from the USB interface of the GOT. For removing methods of the USB memory, refer to the following.

 13.2.9 USB device status display

POINT

- (1) Drives to be used
When installing OS at power-on, use the A or E drive.
- (2) Installation by pressing upper left corner of the GOT screen
When the OS boot drive is set to the A or E drive, installation by pressing upper left corner of the GOT screen is not available.

16.3.2 Installing using the program/data control function (Utility)

For details on program/data control function, refer to the following.

 13. FILE DISPLAY AND COPY (PROGRAM/DATA CONTROL)

POINT

Precaution on executing program/data control function

When execute program/data control function, standard monitor OS has to be installed in GOT in advance. Thus, this function cannot be used for the initial installation of standard monitor OS after purchasing GOT.

Install standard monitor OS by the following two methods.

- (1) GT Designer3
- (2) Installing when starting the GOT

■ Operation procedure

(1) When installing with SD card

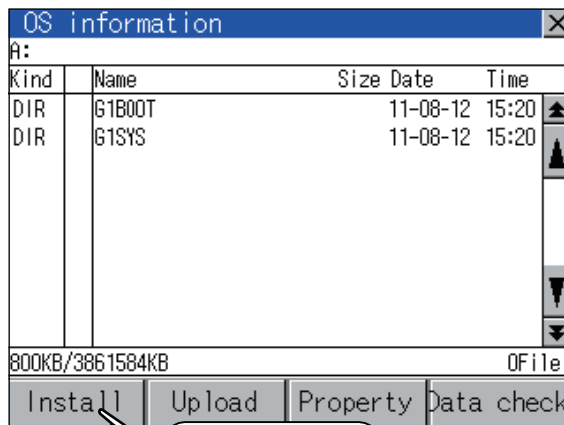

Touch [Install]

Now installing BootOS.

Reboot.

1. Power OFF the GOT. After SD card access LED is off, install the SD card in which BootOS, standard monitor OS or project data is stored in the SD card interface of GOT.
2. Switch ON the SD card access switch of GOT.
3. Display the program/data control function screen (Utility) on the GOT, and install BootOS, standard monitor OS from the SD card to GOT.
4. The SD card access LED is lit during the install execution. Do not pull out the SD card or power off the GOT while the SD card access LED is lit.
5. The GOT restarts automatically after the installation is completed.
6. After confirming normal restart, switch off the SD card access switch of the GOT. Confirm that the card access LED is not lit, and remove the SD card from the SD card interface of the GOT.

(2) When installing with USB memory

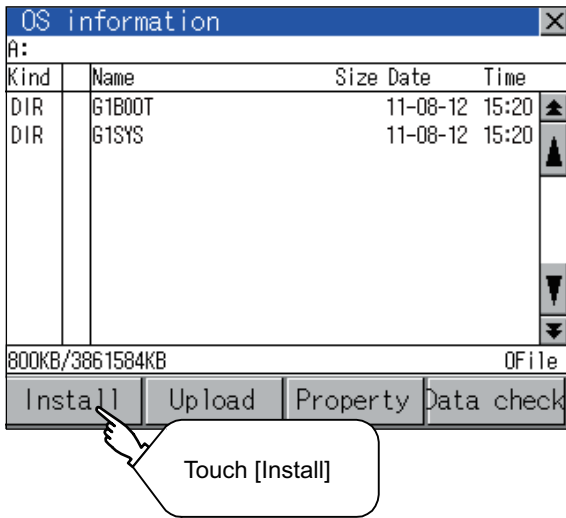

Now installing BootOS.

Reboot.

1. Install the USB memory in which BootOS, standard monitor OS or project data is stored in the USB interface of GOT.
2. Display the data control function screen (Utility) on the GOT, and install BootOS, standard monitor OS.

3. Do not pull out the USB memory or power off the GOT while install execution.

4. The GOT restarts automatically after the installation is completed.

5. After confirming normal restart, display the USB device status screen and remove the USB memory from the USB interface of GOT.

➡ 13.2.9 USB device status display

16.4 When Installing the Different Version of BootOS, Standard Monitor OS

■ BootOS installation

When installing BootOS, GOT compares the version of the BootOS to be installed with the version of BootOS which is already installed.

If the major version of BootOS to be installed is old, execute the following operations to prevent it from being rewritten.

(When installing from GT Designer3, a message is displayed on the PC screen. Follow the instructions in that message.)

(1) When only BootOS is stored in the SD card or USB memory

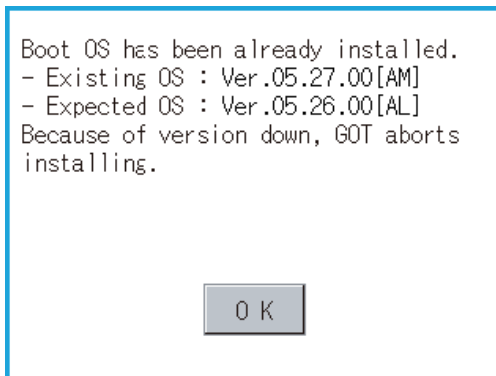

1. The message indicating disabled installation is displayed.
2. Touch the [OK] button to cancel installation. After canceling installation, restart the GOT.

(2) When BootOS, standard monitor OS, and other OS are stored in the SD card or USB memory

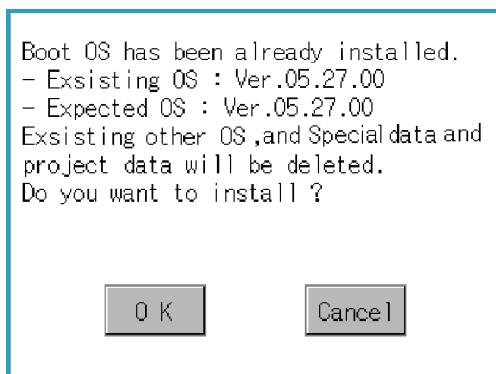

1. Skip the BootOS installation and install standard monitor OS and other OS. If the standard monitor OS is already stored on the GOT, the following message is displayed.
2. Touching the [OK] button executes installation. Touching the [Cancel] button cancels installation. After executing or canceling installation, restart the GOT.

(3) When the version is the same or newer regardless of the data stored in the SD card or USB memory (conditions (1) and (2) above)

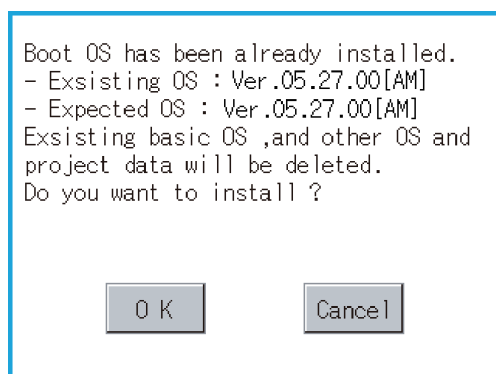

1. The version information and a dialog for selecting whether or not to continue installation are displayed.
2. Touching the [OK] button executes installation. Touching the [Cancel] button cancels installation. After executing or canceling installation, restart the GOT.

(GOT screen when BootOS is installed from SD card or USB memory)

■ Standard monitor OS installation

Match the version of each OS file when installing standard monitor OS.

Standard monitor OS cannot be installed if the version of each OS file does not match.

(When the installation process is discontinued.)

Standard monitor OS : 1.O.O
 Communication driver : 2.O.O
 Optional function OS : 2.O.O

(When the installation process is normally executed.)

Standard monitor OS : 2.O.O
 Communication driver : 2.O.O
 Optional function OS : 2.O.O



Please match the number.

POINT

Checking method of BootOS, standard monitor OS version

- Check the version of BootOS or standard monitor OS installed in GOT at [OS information] of the utility.
 For details, refer to the following.

☞ 13.2.1 OS information

- Check the version of BootOS installed in GOT at product shipment on the rating plate on GOT rear face.

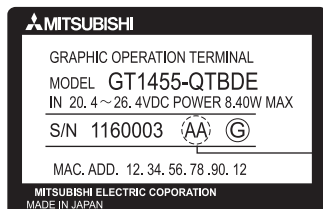

BootOS
version

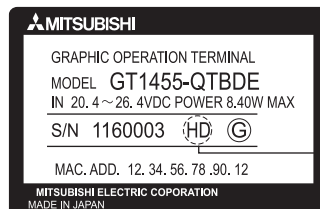

BootOS
Version

When the Boot OS version is 2 digits,
only the lower digit is printed.

Example H/W version: H
 Boot OS version: AD



Rating plate: HD

16.5 CoreOS

Install CoreOS only when the GOT will not be the status of factory shipment even when BootOS is installed. Normally, the CoreOS has not to be installed.

POINT

Precautions for installing CoreOS

When executing the CoreOS installation once, it cannot be canceled on the way.

Do not attempt the following to cancel the installation on the way. The GOT may not operate.

- Powering off the GOT
- Pressing the reset button of the GOT

If the GOT does not operate, please consult your local Mitsubishi (Electric System) Service center or representative.

If the GOT does not recover even when installing the CoreOS, the error may be caused by a hardware failure. Please consult your local Mitsubishi (Electric System) Service center or representative.

16.5.1 Installing the CoreOS

■ Before installing the CoreOS

(1) Installing procedure

The CoreOS can be installed only when using a SD card.
Installation via USB memory/USB/Ethernet is not available.

(2) Boot OS

When installing the CoreOS, the latest BootOS is also installed automatically.
(Operation by the user is not required.)

■ Installing the CoreOS

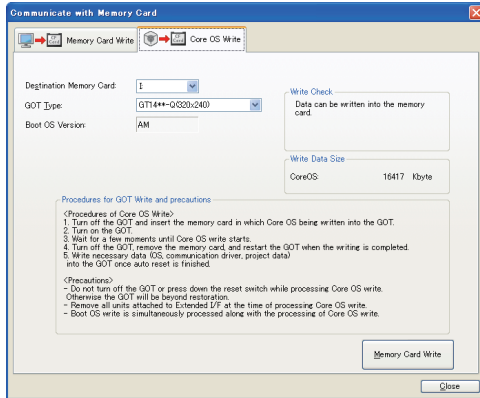

1. Write the CoreOS from GT Designer3 to the SD card.
For details of GT Designer3 operation, refer to the following manual.

 GT Designer3 Version1 Screen Design Manual (Fundamentals)

2. After confirming that the GOT is powered off, install the SD card in the GOT. After installing, switch the SD card access switch on.



3. Powering the GOT on displays the screen on the left.
To cancel the installation, power the GOT off and remove the SD card.

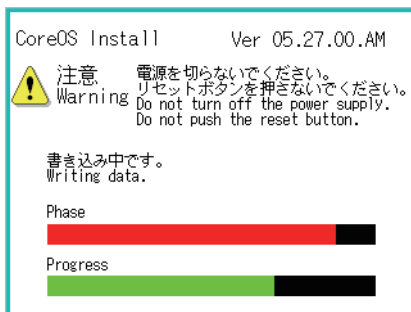

4. Turning the SD card access switch off executes CoreOS installation.



5. When the installation is completed, the dialog as shown on the left is displayed.
(The POWER LED of the GOT blinks (green/orange) at the installation completion.)

6. Confirm that the message is displayed and power the GOT off.



7. Remove the SD card after powering the GOT off.
8. Powering the GOT on again displays the screen as shown on the left.
(The GOT goes to the status of factory shipment.)
Install OS (Standard monitor OS, communication driver, etc.) or download project data as required.

16.5.2 When the CoreOS cannot be installed

When the CoreOS cannot be installed, confirm the following item.

If the CoreOS cannot be installed even after checking the following item, the error may be caused by a hardware failure. Please consult your local Mitsubishi (Electric System) Service center or representative.

Error		Action
The CoreOS installation is not executed even when installing the SD card in the GOT.		(1) Check whether the SD card access switch of the GOT is on. If the switch is off, switch it on. (2) The writing from the GT Designer3 to the SD card may not have been completed normally. Execute the writing from the GT Designer3 to the SD card again.
The message is displayed on the GOT	GOT error. Contact your local sales office.	The GOT main unit is broken. Please consult your local Mitsubishi (Electric System) Service center or representative.
	SD card error. Check whether the SD card can be used. Installation will be cancelled.	The SD card is defective. (1) Format the SD card and re-execute. (2) Replace the SD card.
	GOT type and OS version do not match. Installation will be cancelled.	The GOT type selected at [Core OS write] of the GT Designer3 is not correct. Confirm the GOT type and perform [Core OS write] again.
	The version of OS is not acceptable to this GOT. Installation will be cancelled. Confirm the version of OS.	Install CoreOS from the latest GT Designer3.
	Memory card access switch is off. Installation will be cancelled. Turn on the switch and restart the GOT.	The SD card access switch is off. Turn the switch on and restart the GOT.

17. MAINTENANCE AND INSPECTION

[STARTUP AND MAINTENANCE PRECAUTIONS]	 DANGER
<ul style="list-style-type: none">• When power is on, do not touch the terminals. Doing so can cause an electric shock or malfunction.• Connect the battery correctly. Do not discharge, disassemble, heat, short, solder or throw the battery into the fire. Incorrect handling may cause the battery to generate heat, burst or take fire, resulting in injuries or fires.• Before starting cleaning or terminal screw retightening, always switch off the power externally in all phases. Not doing so can cause the unit to fail or malfunction. Undertightening can cause a short circuit or malfunction. Overtightening can cause a short circuit or malfunction due to the damage of the screws or unit.	

[STARTUP AND MAINTENANCE PRECAUTIONS]	 CAUTION
<ul style="list-style-type: none">• Do not disassemble or modify the unit. Doing so can cause a failure, malfunction, injury or fire.• Do not touch the conductive and electronic parts of the unit directly. Doing so can cause a unit malfunction or failure.• The cables connected to the unit must be run in ducts or clamped. Not doing so can cause the unit or cable to be damaged due to the dangling, motion or accidental pulling of the cables or can cause a malfunction due to a cable connection fault.• When unplugging the cable connected to the unit, do not hold and pull the cable portion. Doing so can cause the unit or cable to be damaged or can cause a malfunction due to a cable connection fault.• Before touching the unit, always touch grounded metal, etc. to discharge static electricity from human body, etc. Not doing so can cause the unit to fail or malfunction.	

[DISPOSAL PRECAUTIONS]	 CAUTION
<ul style="list-style-type: none">• When disposing of the product, handle it as industrial waste.	

The GOT does not include consumable components that will cause the shorten life. However, the battery, liquid crystal display screen and backlight have each life length. It is recommended to replace the battery periodically.
(For the replacement of the liquid crystal screen and backlight, please consult your nearest sales office or FA center.)
For the life of the liquid crystal display screen or backlight, refer to the following.

 3.2 Performance Specifications

17.1 Daily Inspection

■ Daily inspection items

No.	Inspection Item		Inspection Method	Criterion	Action
1	Installation status of GOT		Check for loose mounting screws.	Securely mounted	Retighten screws within the specified torque range.
2	Connection status	Loose terminal screws	Retighten screws with screwdriver.	Not loose	Retighten terminal screws.
		Proximate solderless terminals	Visual check	Proper intervals	Correct.
		Loose connectors	Visual check	Not loose	Retighten connector fixing screws.
3	Usage status	Dirt on protection sheet	Visual check	Not outstanding	Replace with new one.
		Foreign material attachment	Visual check	No foreign matter sticking	Remove, clean.

For the model names of the protection sheet or the replacement procedure, refer to the following.

 8.4 Protective Sheet

17.2 Periodic Inspection

■ Yearly or half-yearly inspection items

The following inspection should also be performed when equipment has been moved or modified or the wiring changed.

No.	Inspection Item		Inspection Method	Criterion	Action	
1	Surrounding environment	Ambient temperature	Make measurement with thermometer or hygrometer. Measure corrosive gas.	Display section	0 to 50°C	For use in control panel, temperature inside control panel is ambient temperature.
		Ambient humidity		Other portions	0 to 55°C	
		Atmosphere		10 to 90%RH		
		No corrosive gas				
2	Power supply voltage check		24VDC Measure voltage across terminals.	20.4 to 26.4VDC	Change supply power.	
3	Mounting status	Looseness	Move module.	Should be mounted firmly.	Retighten screws.	
		Foreign material attachment	Visual check	No foreign matter sticking	Remove, clean.	
4	Connection status	Loose terminal screws	Retighten screws with screwdriver.	Not loose	Retighten terminal screws.	
		Proximate solderless terminals	Visual check	Proper intervals	Correct.	
		Loose connectors	Visual check	Not loose	Retighten connector fixing screws.	
5	Battery		Check GOT internal battery voltage status in [Time Setting & Display] of the Utility. ( 12.1.1 Time setting and display functions)	No alarm displayed	Replace with new battery when the current battery has reached the specified life span, even if battery voltage is not displayed.	

17.3 Cleaning Method

Use the GOT always in a clean condition.

To clean the GOT, wipe the dirty part with a soft cloth using neutral detergent.

For the display operation of the [Clean] screen, refer to the following.

15. CLEANING DISPLAY SECTION (CLEAN)

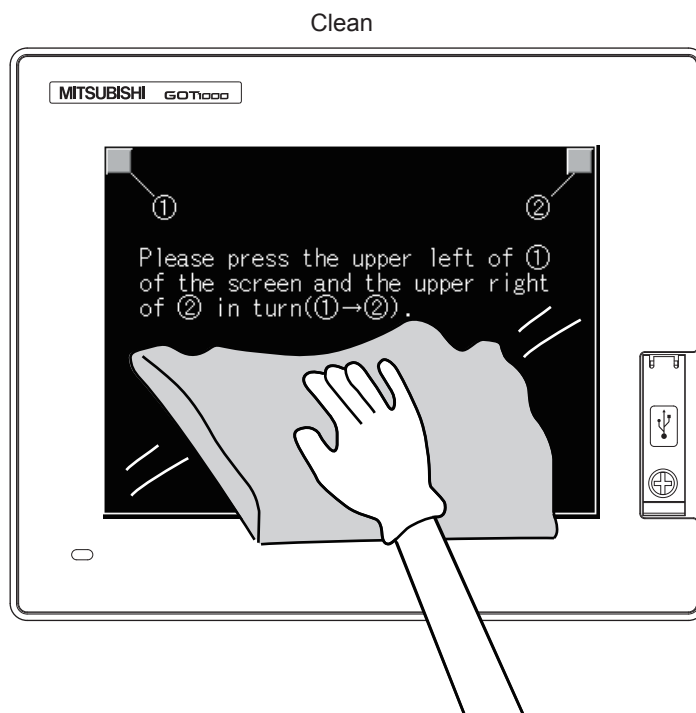

POINT

Precautions for cleaning

Do not use chemicals such as thinner, organic solvents and strong acids, since they may cause the protective sheet to be deformed or the dissolvable paint on the surface to peel off.

In addition, do not use spray solvents since they may cause the electrical failure of the GOT and peripheral devices.

17.4 Battery Voltage Low Detection and Battery Replacement

■ Low battery voltage detection and replacement

Battery contains the data for notifying the maintenance timing and current time. It is recommended that you replace battery periodically. For the replacement procedure, refer to the following.

☞ 8.3 Battery

The battery voltage low detection can be confirmed by the utility screen and system alarm. For details of the battery status display by the utility screen, refer to the following.

☞ 11. DISPLAY AND OPERATION SETTINGS (GOT SET UP)

By using system alarm, the message that notifies the battery voltage has decreased can be displayed at the battery voltage low on the screen of the GOT.

To display the message in the system alarm, set [Battery alarm display] to on.

☞ 11.1.1 Function of Display

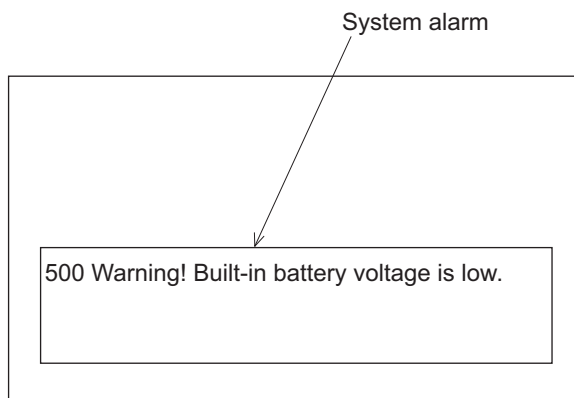

For details of the system alarm display, refer to the following.

☞ GT Designer3 Version1 Screen Design Manual (Fundamentals)

POINT

Battery replacement timing

When detecting voltage low, replace the battery immediately.

Data can be saved for about one month after the battery voltage low detection and cannot be saved after that.

If it exceeds a month from the voltage low detection to battery replacement, the clock data or D-drive (Internal SRAM) data may become indefinite.

Adjust the clock and format the D drive (Internal SRAM).

HINT 

Example of alarm output to external device (lamp, buzzer, etc.)

The following describes an example of outputting the battery voltage low signal from a FX series PLC to an external device with system information.

Condition: The Write Device is "D20" and all data is used (the button is clicked on the setting screen of drawing software) for the system information assignment.

D36 b12: Battery voltage low (System Signal 2-2)

Turned on upon a battery voltage drop.

Used as shown below in the sequence program.

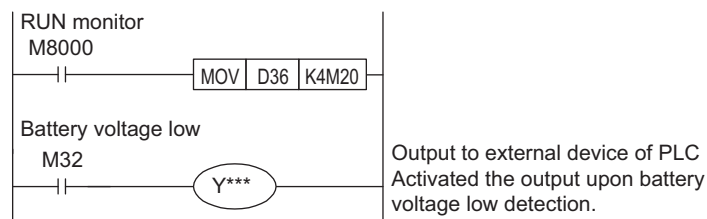

*** indicates the output number at which the external device is connected.

For details of system information, refer to the following.

 GT Designer3 Version1 Screen Design Manual (Fundamentals)

■ Handling of Batteries and Devices with Built-in Batteries in EU Member States

This section describes the precautions for disposing of waste batteries in EU member states and exporting batteries and/or devices with built-in batteries to EU member states.

(1) Disposal precautions

In EU member states, there is a separate collection system for waste batteries. Dispose of batteries properly at the local community waste collection/recycling center.

The following symbol is printed on the batteries and packaging of batteries and devices with built-in batteries used for Mitsubishi Graphic Operation Terminal (GOT).



Symbol

POINT

This symbol is for EU member states only.

The symbol is specified in the new EU Battery Directive (2006/66/EC) Article 20 "Information for end-users" and Annex II.

The symbol indicates that batteries need to be disposed of separately from other wastes.

(2) Exportation precautions

The new EU Battery Directive (2006/66/EC) requires the following when marketing or exporting batteries and/or devices with built-in batteries to EU member states.

- To print the symbol on batteries, devices, or their packaging
- To explain the symbol in the manuals of the products

(a) Labeling

To market or export batteries and/or devices with built-in batteries, which have no symbol, to EU member states on September 26, 2008 or later, print the symbol shown in (1) on the GOT or their packaging.

(b) Explaining the symbol in the manuals

To export devices incorporating Mitsubishi Graphic Operation Terminal to EU member states on September 26, 2008 or later, provide the latest manuals that include the explanation of the symbol.

If no Mitsubishi manuals or any old manuals without the explanation of the symbol are provided, separately attach an explanatory note regarding the symbol to each manual of the devices.

POINT

The requirements apply to batteries and/or devices with built-in batteries manufactured before the enforcement date of the new EU Battery Directive (2006/66/EC).

17.5 Backlight Shutoff Detection

The backlight is built into GOT for the liquid crystal display.

When GOT detects backlight shutoff, the POWER LED blinks green/orange alternately.

The brightness of the backlight decreases with the lapse of usage period. When backlight shutoff is detected or the display becomes unclear, replace the backlight. (GT14 requires LED replacement.)

For replacement of the backlight, contact your nearest sales office or FA Center.

(1) Life of backlight

The usable duration of backlight can be extended by setting to "Screen saving backlight off" in the utility of GOT (GOT set up). For details, refer to the following.

 11. DISPLAY AND OPERATION SETTINGS (GOT SET UP)

17.5.1 Backlight shutoff detection and external alarm

When the GOT detects a backlight shutoff, the system information set with drawing software is turned on.

You can issue a backlight shutoff of the GOT from the PLC to external devices (such as the lamp or buzzer), using system information.

To avoid any screen touch operation by the user who misunderstands it is in screen saving mode, install an external alarm and interlock the loads that would cause danger.

For details of the system information, refer to the following.

 GT Designer3 Version1 Screen Design Manual (Fundamentals)

HINT

Example of alarm output to external device (lamp, buzzer, etc.)

The following provides an example of outputting the backlight shutoff detection signal from a FX Series PLC to an external device, using system information.

Condition: The Write Device is "D20" and all data is used (the button is clicked on the setting screen of drawing software) for the system information assignment.

D36 b14: Backlight shutoff detection (System Signal 2-2)

Turned on upon a backlight shutoff.

Used as shown below in the sequence program.

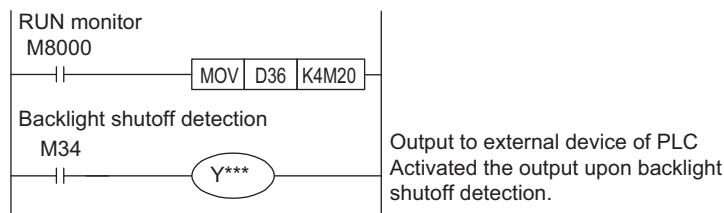

"**" indicates the output number at which the external device is connected.

POINT

Precautions for the backlight shutoff status

In the backlight shutoff status, the touch key operates.

Early replacement of backlight is recommended.

18. TROUBLESHOOTING

This chapter explains the GOT restoration sheet and the error message/system alarm list.

18.1 GOT Restoration Sheet

This section provides restoration methods for the case the GOT does not operate normally, which are listed in check sheets.

The following explains how to use each sheet.

- (1) When the GOT does not operate or malfunctions (GOT status check sheet)
When the GOT does not operate or malfunctions, identify the cause of the malfunction etc. with GOT status check sheet and take corrective action.
When the GOT is restored, see the status for a while.
- (2) When the wiring status needs to be improved (GOT installation status check sheet)
When the noise caused by the GOT wiring status is considered to have caused the malfunction, etc. based on the check result of (1) above, take corrective action for wiring using GOT installation status check sheet.
When the GOT is restored, see the status for a while.
- (3) When corrective action other than (1) and (2) above is required (System configuration check sheet)
If malfunction etc. occurs even after checking with (1) and (2) above, please contact your local Mitsubishi (Electric System) Service after filling out System configuration check sheet with details about your system.
When sending a troubled product, attach the GOT restoration sheets (GOT status check sheet, GOT installation status check sheet, System configuration check sheet) checked in this section.
Please keep copies of the restoration sheets.

■ GOT status check sheet

Check the GOT starting from (1) GOT status.
Proceed as instructed by "Action".

(1) GOT status

Phenomenon	Cause/status	Action
(a) Frequency when the GOT does not operate, an error occurs on the screen, etc.		
<input type="checkbox"/> Occurs always.	Occurrence frequency: () Example: Once a month	Proceed to (1)-(b).
<input type="checkbox"/> Occurs sometimes.		
(b) Checking of the displayed error code (system alarm)		
<input type="checkbox"/> Can be checked.	Error code (system alarm): () Example: 460 Communication unit error	Take the action for the error code (system alarm) or error message checked. If the status does not change after the action is taken, proceed to (1)-(c).
<input type="checkbox"/> Cannot be checked.		Proceed to (1)-(c).
(c) POWER LED		
<input type="checkbox"/> Lit in green	The power is supplied normally.	Proceed to (1)-(d).
<input type="checkbox"/> Lit in orange	Screen saving is being performed. The read device of the system information may have been turned ON when the device was set, and the screen was switched to the forced screen saving status.	Check the setting of the read device. When no problem is found in the setting, proceed to (1)-(d).
<input type="checkbox"/> Blinks in green/orange	The backlight has run out.	Replace the backlight. If the GOT is not restored, proceed to (1)-(d).
<input type="checkbox"/> Not lit	The power is not supplied. When the power is supplied, the GOT hardware may be faulty.	Check if the power is supplied. If the GOT is not restored, proceed to (5) Troubled product investigation.
(d) Screen display		
<input type="checkbox"/> The screen is completely black.	The liquid crystal display or BootOS may be faulty.	Perform the following in order. 1) Reinstalling BootOS 2) Reinstalling standard monitor OS If the GOT is not restored by 1) and 2), perform the following. 3) Reinstalling CoreOS and then standard monitor OS If the GOT is not restored by the above operations, proceed to (5) Troubled product investigation.
<input type="checkbox"/> The screen is completely white.	The GOT hardware may be faulty.	Proceed to (5) Troubled product investigation.
<input type="checkbox"/> A line is displayed on the screen.	The GOT hardware may be faulty. Example: A vertical line is displayed.	Proceed to (5) Troubled product investigation.
<input type="checkbox"/> Other faulty displays		
<input type="checkbox"/> The screen freezes.	The screen display is not updated and any operation is not allowed.	Proceed to (1)-(e).

Phenomenon	Cause/status	Action
(e) Buzzer sound		
<input type="checkbox"/> Does not sound.	Buzzer sound: () Example: The rhythm as three beeps, one beep, and then two beeps is repeated.	Proceed to (2) Status of the GOT when it freezes.
<input type="checkbox"/> Continues to beep randomly.		
<input type="checkbox"/> Continues to beep in a particular pattern.		
<input type="checkbox"/> Beeps continuously.	The read device of the system information may have turned ON when the device was set, turning ON the Buzzer output signal.	Check the setting of the read device. When the Buzzer output signal has no error, proceed to (2) Status of the GOT when it freezes.

(2) Status of the GOT when it freezes (screen operation stopped)

Phenomenon	Cause/status	Action
(a) Switching to the utility		
<input type="checkbox"/> Enabled	Error code (system alarm): () Example: 460 Communication unit error	When the system alarm display function can be used, take the action for the error code (system alarm) displayed. If the action cannot be taken, proceed to (2)- (b).
<input type="checkbox"/> Disabled	The system alarm display function cannot be used.	Proceed to (2)-(c).

(b) Executing of I/O check from the GOT utility

<input type="checkbox"/> Communication error	Display details: () Example: A message indicating the cause may be a connection error was displayed.	Proceed to (2)-(c).
<input type="checkbox"/> No error	The hardware such as a communication interface has no error.	Proceed to (3) Status of the PLC CPU.

(c) Objects not displayed on the monitor screen

<input type="checkbox"/> Found	Details: ()	Proceed to (3) Status of the PLC CPU.
<input type="checkbox"/> Not found	Example: The numerical display object is not displayed.	

(3) Status of the PLC CPU

Phenomenon	Cause/status	Action
(a) PLC failure		
<input type="checkbox"/> Occurs always.	An error such as CONTROL-BUS. ERROR or SP. UNIT LAY. ERROR may have occurred. Error code (system alarm): () Example: 1204 CPU H/W fault	Proceed to the following.  18.1
<input type="checkbox"/> Occurs sometimes.	The PLC CPU may be influenced by noise or the hardware may be faulty. Occurrence frequency: () Example: Once a month Error code (system alarm): () Example: 1204 CPU H/W fault	Proceed to (4) GOT restoration procedure.
<input type="checkbox"/> Operates normally.	-	

(4) GOT restoration procedure

Follow the procedures below starting from (a) and in order to check if the GOT is restored.
If the GOT is not restored, proceed to the next item.

Check item	Cause	Action
(a) Press the GOT reset switch. <input type="checkbox"/> Restored <input type="checkbox"/> Not restored (Proceed to (b).)	The GOT may have malfunctioned temporarily due to noise.	Take the action of (4)-(h).
(b) Power the GOT ON/OFF.* ¹ <input type="checkbox"/> Restored <input type="checkbox"/> Not restored (Proceed to (c).)		
(c) Reset or power ON/OFF the PLC CPU. <input type="checkbox"/> Restored <input type="checkbox"/> Not restored (Proceed to (d).)		
(d) Power the GOT and PLC CPU ON/OFF simultaneously. <input type="checkbox"/> Restored <input type="checkbox"/> Not restored (Proceed to (e).)		
(e) Connect the cable again. <input type="checkbox"/> Restored <input type="checkbox"/> Not restored (Proceed to (f).)	The cable connection may be faulty.	Securely connect the cable. If an error occurs again, proceed to (5) Troubled product investigation.
(f) Reinstall the project data. <input type="checkbox"/> Restored <input type="checkbox"/> Not restored (Proceed to (g).)	Data may have been destroyed by an action such as powering the GOT OFF during the installation of project data or OS.	Do not power the GOT OFF while transferring data. If an error occurs again, proceed to (5) Troubled product investigation.
(g) Reinstall the OS. <input type="checkbox"/> Restored <input type="checkbox"/> Not restored (Proceed to (h).)		
(h) Take the action described in the "Action" column. <input type="checkbox"/> Restored <input type="checkbox"/> Not restored (Proceed to (i).)	The GOT may have malfunctioned temporarily due to noise.	Take the action with referring to GOT installation status check sheet.
(i) The GOT is not restored even by performing (a) to (h).	-	Proceed to (5) Troubled product investigation.

*1 When powering the GOT ON again (OFF → ON), power OFF the PLC before that.

(5) Troubled product investigation

When malfunction of the GOT is not improved, please contact your local Mitsubishi (Electric System) Service. Depending on the problem details, we may ask you to return the troubled product to us.

In that case, please attach the GOT status check sheet, GOT installation status check sheet, and the system configuration check sheet filled out with details of your system.

■ GOT installation status check sheet

Check the current installation status of the GOT you are using against the GOT installation status described in the upper column of items (1) to (7).

When the measure described in the lower column is needed, take the measure for the current status.

When the measure is taken, check the result, "Effective" or "Ineffective".

(1) Panel inside wiring

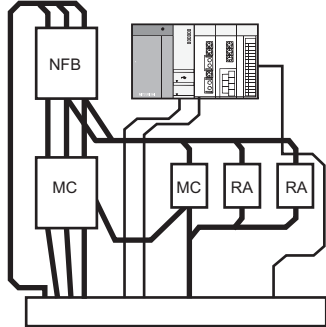
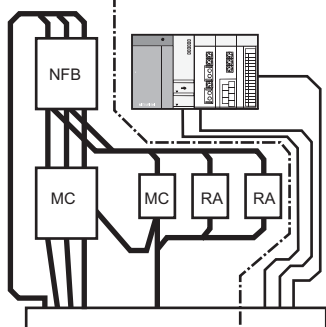
<p>Current status</p> 	<p>The power line connected to the power or servo amplifier and the communication cable are mixed in the duct.</p>	<p><input type="checkbox"/> Mixed <input type="checkbox"/> Not mixed</p>
<p>Measure for the cables mixed</p> 	<p>Wiring the power line and communication cable in the panel without mixing them in the duct can reduce the influence of noise.</p>	<p><input type="checkbox"/> Effective <input type="checkbox"/> Ineffective</p>

(2) Panel outside wiring

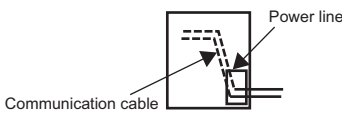
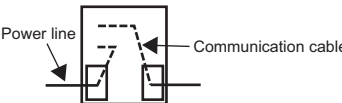
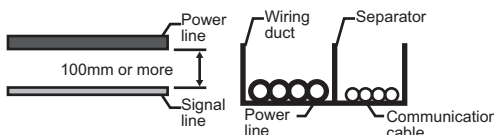
<p>Current status</p> 	<p>The power line and communication cable are installed together.</p>	<p><input type="checkbox"/> Installed together <input type="checkbox"/> Not installed together</p>
<p>Measure for the cables installed together</p> <p>Fig. A</p>  <p>Fig. B</p> 	<p>Leading the power line and communication cable outside the panel at separate places can make the communication cable less influenced by noise from the power line. Installing the communication cable apart from the power line or using a separator (made of metal) in the duct as shown in Fig. B can make the communication cable less influenced by noise.</p>	<p><input type="checkbox"/> Effective <input type="checkbox"/> Ineffective</p>

(3) Wiring of GOT's FG cable and power line

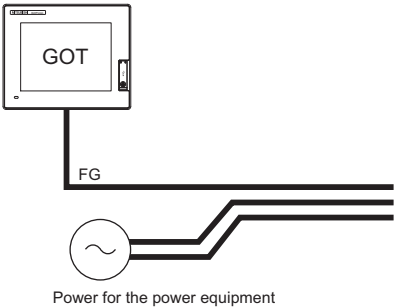
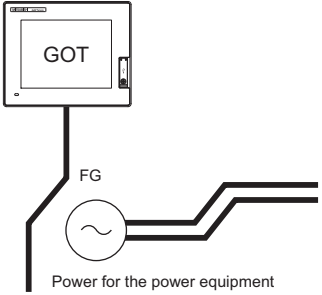
<p>Current status</p> 	<p>The FG cable and power line of the GOT are installed together.</p>	<input type="checkbox"/> Installed together <input type="checkbox"/> Not installed together
<p>Measure for the cables installed together</p> 	<p>Separating the FG cable and power line of the GOT in wiring reduces the influence of noise.</p>	<input type="checkbox"/> Effective <input type="checkbox"/> Ineffective

(4) Surge measures

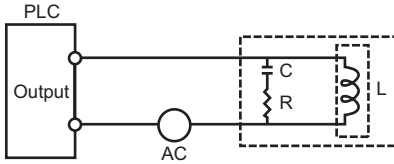
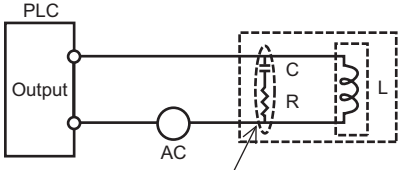
<p>Current status</p> 	<p>A surge suppressor is used for the wiring of the load such as MCCB, electromagnetic contactor, relay, solenoid valve, or induction motor.</p> <p>(When a surge suppressor is used, fill out the entry area below with the surge suppressor model name and the name of the equipment for which the surge suppressor is used.)</p>	<input type="checkbox"/> Used <input type="checkbox"/> Not used
<p>Measure for the equipment without a surge suppressor used</p>  <p>The surge suppressor must be attached close to the load</p>	<p>Attaching the surge suppressor on the cable close to the load can reduce the influence of surge on the GOT.</p>	<input type="checkbox"/> Effective <input type="checkbox"/> Ineffective

Entry area

Model name of the surge suppressor	Equipment name

(5) Grounding status

<p>Current status</p>		<p>The FG cables of the control equipment (such as PLC) and the power equipment (such as servo amplifier) are connected as shown by "a".</p>	<p><input type="checkbox"/> Connected <input type="checkbox"/> Not connected</p>
<p>Measure for the FG cables connected</p>		<p>Perform independent grounding at two places as shown in Fig. A. Independent grounding can reduce the influence of noise. If independent grounding is not allowed, be sure to perform shared grounding as shown in Fig. B.</p>	<p><input type="checkbox"/> Effective <input type="checkbox"/> Ineffective</p>

(6) Grounding status of the panel on which the GOT is installed

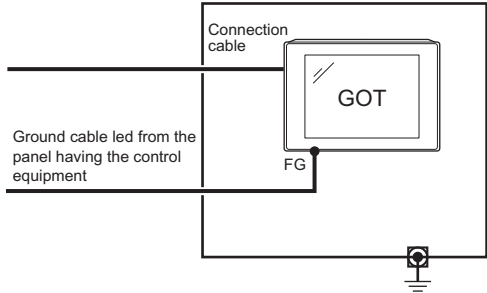
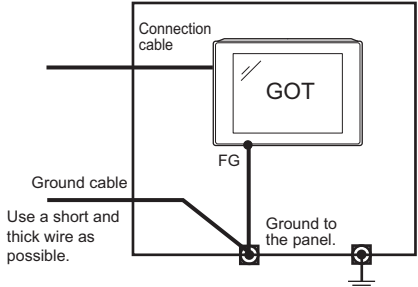
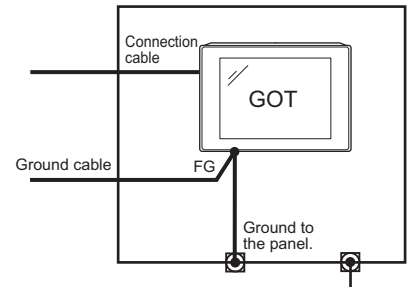
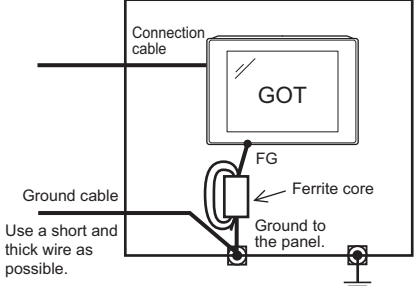
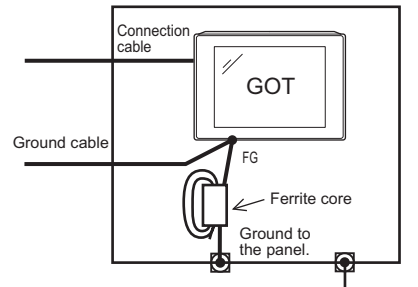
<p>Current status</p> 	<p>A single ground cable is led from the panel having the control equipment such as PLC to the panel having the GOT.</p>	<p><input type="checkbox"/> Led <input type="checkbox"/> Not led</p>
<p>Fig. A</p>  <p>Fig. B</p> 	<p>Connecting the ground cable to the panel having the GOT as shown in Fig. A to reduce the potential difference may prevent the malfunction.</p> <p>When wiring as shown in Fig. A is difficult, perform wiring as shown in Fig. B.</p>	<p><input type="checkbox"/> Effective <input type="checkbox"/> Ineffective</p>
<p>Measure for the ground cable led</p> <p>Fig. C</p>  <p>Fig. D</p> 	<p>Attaching the ferrite core to the ground cable connected to the panel having the GOT as shown in Fig. C reduces the influence of noise.</p> <p>When wiring as shown in Fig. C is difficult, perform wiring as shown in Fig. D.</p>	<p><input type="checkbox"/> Effective <input type="checkbox"/> Ineffective</p>

(7) Power supply system

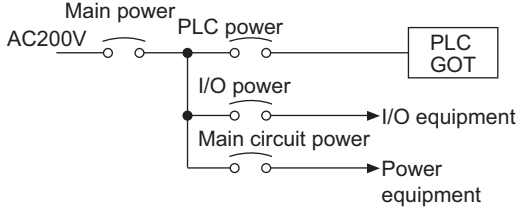
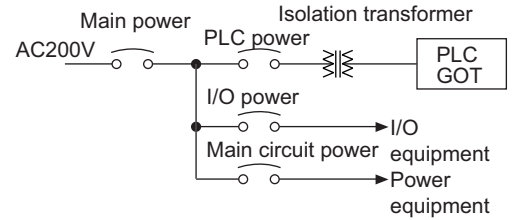
<p>Current status</p> 	<p>The power from the same system is used for the GOT, I/O equipment (such as relay), and power equipment (such as servo amplifier).</p>	<input type="checkbox"/> Used <input type="checkbox"/> Not Not used
<p>Measure for the equipment for which the power from the same system is used</p> 	<p>Connecting an isolation transformer as well as separating the wiring of the GOT power from that of the power of the I/O equipment and power equipment reduces the influence of noise.</p>	<input type="checkbox"/> Effective <input type="checkbox"/> Ineffective

■ System configuration check sheet

Fill in the brackets with the unit/module name.

(1) System configuration of the GOT			
(a) GOT main unit		[]
(b) Communication interface		[]
(c) Cable between the PLC and GOT		[]
(d) Cable length		[m]

(2) System configuration of the PLC			
(a) Power supply module		[]
(b) CPU module		[]
(c) Serial communication unit/computer link module	<input type="checkbox"/> Used <input type="checkbox"/> Not used	[]
(d) Network module	<input type="checkbox"/> Used <input type="checkbox"/> Not used	[]
(e) Interrupt module	<input type="checkbox"/> Used <input type="checkbox"/> Not used	[]
(f) Positioning module	<input type="checkbox"/> Used <input type="checkbox"/> Not used	[]
(g) Number of extension stages		[stages]
(h) If any other module etc. is used, please describe it.			

Entry area for recurrence (when the malfunction occurred after the action is taken)

(3) Describe the operation situation when freezing of the screen or faulty display of the GOT has reoccurred.

18.2 Error Message and System Alarm

This chapter describes the error message and system alarm displayed in the GOT.

As the error code and error message displaying functions when an error occurs at the GOT, controller or network, there are two kinds: system alarm and advanced system alarm.

For details of the system alarm and advanced system alarm, refer to the following.

 GT Designer3 Version1 Screen Design Manual (Functions)

POINT

Error code and channel No.

- Error codes can also be confirmed in the error code storage area of the system information function.
- The channel No. where an error is occurring can be confirmed with the GOT special register (GS262 to 264).
For details of the system information and GOT special register, refer to the following manual.

 GT Designer3 Version1 Screen Design Manual (Fundamentals)

18.2.1 Error contents display

This section describes the example for displaying error code and error message on GOT.

■ Popup-displaying the error code and error message (Advanced alarm popup display (System alarm))

If an error occurs, the error code and error message can be popup-displayed on the front of the monitor screen. As alarms are popup-displayed regardless of the screen type, the error occurred will not be overlooked.



Pop up generated alarms regardless of the screen.

■ Displaying error code and error message in a list (Advanced system alarm display)

If error has occurred, error code and error message can be displayed on the list set with the screen. Multiple errors can be displayed, or the history of display can be recorded.

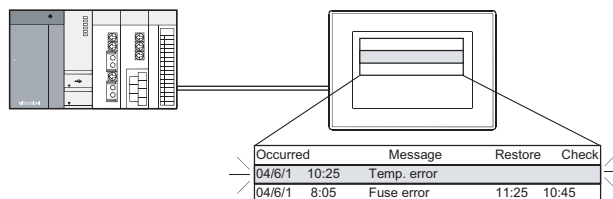

Create a screen to display alarms, and confirm the details of the alarms and take measures.

■ Checking error messages with the utility (Utility)

The error code and error message can be checked with the system alarm display of the utility when the object is not set.

14.3 System Alarm Display

Error code and reference manual

Error source	Error code	Description	Channel No. storage destination* ¹	Reference
Controller	0 to 99 (Value of D9008)	Error code of CPU (for ACPU)	GS263	User's manual of the ACPU connected with GOT
	100 to 299	Error code of the following controllers FXCPU* ² Third party PLC Temperature controller (OMRON temperature controller only)		User's manual of the controller connected with the GOT Deal with errors according to the error messages.
GOT* ⁵	300 to 399	Error code of the GOT main unit function	GS262* ⁴	 18.2 Error Message and System Alarm
	400 to 499	Error code of the GOT communication function		
	500 to 699	Error code of the GOT main unit function		
Network	800 to 999	Error code of network	GS264	
CPU	1000 to 10000 (Value of SD0)	Error code of CPU (for QCPU, QnACPU)	GS263	User's manual of the QCPU and QnACPU connected with GOT
Motion controller	10001 to 10999	Error code of Motion controller (Q173DCPU/Q172DCPU)		User's manual of the Motion controller connected with GOT
CNC C70	11000 to 11999	Error code of CNC (Q173NCCPU)		User's manual of the CNC C70 connected with GOT
Robot controller	12000 to 12999	Error code of Robot controller (Q172DRCPU)		User's manual of the Robot controller connected with GOT
Servo amplifier* ³	20016 to 20237	Error code of servo amplifier		User's manual of the servo amplifier connected with GOT

*1 For details of GOT special registers (GS262 to 264), refer to the following manual.

 GT Designer3 Version1 Screen Design Manual (Fundamentals)

*2 The assigned error code for FXCPU is 100 to 109, which displays the status of M8060 to M8069.
(Example) When the error code (100) error occurs, correct the error according to the M8060 description.

*3 The error code displayed on GOT is calculated by changing the error code (Hexadecimal) displayed on the servo amplifier to the decimal number and adding 20000 to it.

When referring to the manual of servo amplifier by the error code displayed as a GOT system alarm, subtract 20000 from the GOT error code and change its lower three digits to the hexadecimal number.

(Example: When GOT system alarm is 20144, the error code of servo amplifier becomes 90H.)

*4 Channel No. will not be stored depending on the error code.

For channel No. storage availability for each error code, refer to the following.

 18.2.2 List of error message/system alarm

*5 An alarmed drive cannot be confirmed in the system alarm regarding file access; however, it can be specified by confirming the file access error signal (b7 to 10) of system signal 2-2.

18.2.2 List of error message/system alarm

The system alarm detected with GOT is shown below.

Error code	Error message	Action	Channel No. storage
303	Set monitor points too large. Decrease setting points.	Decrease the number of objects from the displayed screen. For the number of maximum objects for 1 screen, refer to the following.  GT Designer3 Version1 Screen Design Manual (Fundamentals)	×
304	Set trigger points too large. Decrease setting points.	The number of objects using Sampling/Cycle during ON/Cycle during OFF exceeds 100. Decrease the number of objects.	×
306	No project data. Download screen data.	The project data is not downloaded or the screen data is not sufficient. Download the project data or screen data.	×
307	Monitor device not set	The monitor device of the object is not set. Set the monitor device of the object.	×
308	No comment data. Download comment.	The comment file does not exist. Create the comment file and download to GOT.	×
309	Device reading error. Correct device.	The error occurred when reading a continuous device. Correct the device.	×
310	Project data does not exist or out of range.	<ul style="list-style-type: none"> Specified base screen / window screen does not exist in the project data. Specified base screen / window screen is out of the permissible area. Specify the existing base screen / window screen. 	×
311	No. of alarm has exceeded upper limit. Delete restored alarm.	The number of alarm histories that can be observed by the alarm history display function has exceeded the maximum points. Delete the restored history to decrease the number of alarm histories.	×
312	No. of sampling has exceeded upper limit. Delete collected data.	The collection frequency exceeded the upper limit when "Store Memory" and "Accumulate/Average" were set in the scatter graph. <ul style="list-style-type: none"> Approve "Clear trigger" setup in the scatter graph. Set the "Operation at frequency over time" to "Initialize and Continue" in scatter graph. 	×
315	Device writing error. Correct device.	Error occurred while writing in the device. Correct the device.	×
316	Cannot display or input operation value. Review expression.	In indirect specification of comment/parts number, the data operation result exceeded the range in which device type can be expressed. Review the data operational expression, in order not exceeding the range in which the device type can be expressed.	×
317	Too high frequency of data collection. Review conditions.	Data of an object, to which [Collect data only when trigger conditions are satisfied] is set, are collected too frequently, or the number of objects has exceeded the number of objects collectable simultaneously. Set a longer cycle for trigger occurrence to each object. Make the settings so that 257 or more display triggers of objects, to which [Collect data only when trigger conditions are satisfied] is set, do not occur simultaneously.	×
320	Specified object does not exist or out of range.	The part file does not exist. Create the part file and download to GOT.	×
322	Dedicated device is out of range. Confirm device range.	The monitored device No. is out of the permissible area of the targeted PLC CPU. Set the device within the range that can be monitored by the monitored PLC CPU and parameter settings.	×

Error code	Error message	Action	Channel No. storage
330	Insufficient memory media capacity. Confirm M-card capacity.	Available memory of the SD card is insufficient. Confirm the available memory of the SD card. The available memory can be confirmed by system information screen, which is described in GT Designer3 Version1 Screen Design Manual (Fundamentals).	×
331	Memory card not installed or MCARD switched OFF	The SD card is not installed or in the drive access switch is OFF in drive. • Install the SD card in the specified drive. • Turn ON the access switch.	×
332	Memory media is not formatted.	SD card is not formatted or formatted incorrectly. Format the SD card.	×
333	Unable to overwrite. Memory card is write-protected.	SD card is write-protected. Cancel the write-protection of SD card.	×
334	Memory media error. Replace memory media.	SD card is faulty. Replace the SD card.	×
337	File output failed. Confirm output file path.	Either of the following folder or file with the name same as the file to be created exists in the storage destination SD card or USB memory. • Folder storing data • Write-protect file Delete the above folder or file, or change the name of the file to be created.	×
340	Printer error or power failure.	Printer is faulty or the printer power supply has not been turned on. • 1. Confirm the printer. • 2. Turn on the power supply of the printer.	×
341	Printer error	Printer is faulty or the printer power supply has not been turned on. • 1. Confirm the printer. • 2. Turn on the power supply of the printer.	×
345	BCD/BIN conversion error Correct data	Any value that cannot be converted to a BCD/BIN value is being displayed/input. • Change the device data to be displayed to the BCD value. • Correct the input value to the 4 digits integer.	○
351	Recipe file error. Confirm content of recipe file.	The contents of the recipe file are not normal. • Confirm the contents of the recipe files in the SD card or USB memory. • Reboot the GOT after deleting the recipe file in the SD card or USB memory (format).	×
352	Recipe file make error. Reboot GOT after inserting memory card.	Failed to generate recipe file. Reboot the GOT after installing the SD card or USB memory.	×
353	Unable to write Recipe file. Confirm memory card is inserted.	Failed to write in the recipe file. • Confirm the write-protection of the SD card or USB memory. • Confirm the contents of the SD card or USB memory. • Do not pull out the SD card or USB memory while recipe is operating.	×
354	Recipe file write error	Error occurred while writing in the recipe file. Do not pull out the SD card or USB memory while recipe is operating.	×
355	Recipe file read error	Error occurred while reading in the recipe file. • Do not pull out the SD card or USB memory while recipe is operating. • Confirm the contents (device value) of the recipe file in the SD card or USB memory.	×

Error code	Error message	Action	Channel No. storage
356	File system error occurred in PLC. Confirm file register.	Error occurred in the specified file register when executing the recipe function by specifying the file register name. <ul style="list-style-type: none"> Execute the recipe function again after confirming the file register name. Execute the recipe function again after formatting the PC memory in the specified PLC CPU drive with GX Developer. 	×
357	Error in specified PLC drive Confirm PLC drive.	When executing the recipe function specifying the file register name, error occurred in PLC CPU drive. <ul style="list-style-type: none"> Execute the recipe function again after confirming the specified PLC CPU drive. Execute the recipe function again after formatting the PC memory in the specified PLC CPU drive with GX Developer. 	×
358	PLC file access failure. Confirm PLC drive.	When the recipe function is executed specifying the file register name, PLC CPU file register could not be accessed. <ul style="list-style-type: none"> Execute the recipe function again after confirming the specified PLC CPU drive / file register name. (When you specify drive 0, execute the recipe function again after changing to other drives.) Confirm whether the SD card or USB memory are write-protected, and execute the recipe function again. 	×
359	Processing from another peripheral device. Execute it after.	When the recipe function is executed specifying the file register name, other peripherals carry out the process to the file register. Wait until the processing of other peripherals end, and execute the recipe function again.	×
360	0 divisor division error. Confirm operation expression.	Zero division occurred by the data operational expression. Review the data operational expression so that the divisor should not become 0.	×
361	Specified device No. is out of range.	The entered file number is out of range. Check the entered file number, and enter a valid value (1 to 9999).	×
362	Invalid device value in time action setting	When controllers are controlled with the GOT's time action function, the set No. is out of range, or the set device values regarding the operation settings are out of range or invalid. Set valid values.	×
370	Upper and lower limit value error. Confirm value setting.	The setting of lower/upper limit value is [Upper limit < Lower limit]. Correct the setting so as to be "Upper limit >= Lower limit".	×
380	Insufficient USB drive capacity. Confirm the drive capacity.	Available memory of the USB memory is insufficient. Confirm the available memory of the USB memory, and increase the memory if it is low.	×
381	USB drive is not installed or in a removable state.	If the USB memory is not installed, install it. If the USB memory is ready to be removed, install it again.	×
382	USB drive is not formatted.	Memory card is not formatted or in a format not conformed by a GOT. Reformat the USB memory.	×
383	Unable to overwrite. USB drive is write-protected.	USB memory is write-protected. Cancel the write-protection of USB memory.	×
384	USB drive error. Replace USB drive.	USB memory is faulty. Replace the USB memory.	×

Error code	Error message	Action	Channel No. storage
402	Communication timeout. Confirm communication pathway or modules.	The time-out error occurred during communicating. <ul style="list-style-type: none"> Confirm the cable omission and status of the PLC. Channel No. is not displayed in error code or error message in the case an error occurs when using the multi-channel function. Refer to the following manual to identify the channel No. in error. This error may occur when the load of the PLC CPU becomes heavier when accessing other stations. In such a case, transfer the data of the other stations to the host station PLC CPU and monitor them at the host. Put COM instruction when the PLC scanning is long. 	○
403	SIO status error. Confirm communication pathway or modules.	Either of the overrun error, parity bit error or flaming error was generated when the RS-422 / RS-232 communication was received. Confirm the cable omission, status of the PLC and the transmission speed of the computer link. Channel No. is not displayed in error code or error message in the case an error occurs when using the multi-channel function.	○
406	Specified station access is out of range. Confirm station no.	<ul style="list-style-type: none"> Station numbers other than master/local station are specified at the CC-Link connection (via G4). A PLC CPU other than QCPU is accessed. Confirm the station number of the project data. 	○
407	Accessed other network. Change network setting.	<ul style="list-style-type: none"> When monitoring other networks Reconfigure the [Routing Information Setting] of GT Designer3 or the [Routing parameters] of GX Developer. 	○
410	Cannot perform operation because of PLC run mode. stop the PLC.	The operation, which could not be performed during RUN of PLC CPU, was performed. Stop the PLC CPU.	○
411	Memory cassette is writeprotected. Check the memory cassette.	The memory cassette installed in the PLC CPU is EPROM or E ² PROM, and it is in a protected status. Confirm the memory cassette installed in PLC CPU.	○
412	Cannot read/write device protected by keyword. Remove keyword.	The key word is set in PLC CPU. Cancel the key word.	○
420	E71 specification is ASCII.	[ASCII code] is selected in [Ethernet operations] of the PLC side setting. Select [Binary code].	○
421	E71 is set as read-only. Clear setting.	The Ethernet module on the PLC side is set in read-only. Set the Ethernet module on the PLC side to write-enabled.	○
422	Not communicating between CPU and E71. Confirm CPU error.	PLC CPU error. Communication between PLC CPU and the PLC side Ethernet module impossible. Confirm whether there is error in PLC CPU by GX Developer etc. (Confirm buffer memory)	○

Error code	Error message	Action	Channel No. storage
423	Insufficient network table information. Add station no.	<p>The station number set in the project data and the station number set in the switching station No. device do not exist in the Ethernet setting of GT Designer3.</p> <ul style="list-style-type: none"> • Add the station number set in the project data to the Ethernet setting of GT Designer3. • When using the station No. switching function, check the data of the switching station No. device. <p>When the station number specified in the switching station No. device is not set in the Ethernet setting, add the station number to the Ethernet setting.</p> <p>When the station number does not exist in the system, change the data of the switching station No. device.</p> <p>(Set the station number so that it becomes the same as the station number of the PLC side Ethernet module set in the parameter setting of GX Developer.)</p>	○
424	Same sta. on GOT & project data. Review communication parameter.	<p>The station number set in the GOT's utility is the same as the station number set in the Ethernet setting of GT Designer3 or GT Designer2 (the station number of the PLC side Ethernet module) or in the project data. Check the following contents so that the multiple station numbers should not be the same.</p> <ul style="list-style-type: none"> • Check the GOT's station number in the GOT's utility. • Check the station number set in the project data. • Check the station number set in the Ethernet setting. <p>(Set the station number so that it becomes the same as the station number of the PLC side Ethernet module set in the parameter setting of GX Developer.)</p> <ul style="list-style-type: none"> • When using the station No. switching function, check the data of the switching station No. device. 	○
425	A duplicate IP address has been detected. Confirm the setting.	<p>The IP address of the GOT is the same as that of the controller. Change the IP address of the GOT or the controller.</p>	○
448	PLC cannot handle as requested. Correct devices.	<p>A device outside the range of PLC file registers and the buffer memory was specified. Correct the monitor device by setting file register of the PLC CPU.</p>	○
449	Dedicated device is out of range. Confirm device range.	<p>Set the address for the special function module in the GOT monitor available range. Set the device in the GOT monitor available range.</p>	○
450	Path has changed or timeout occurred in redundant system.	<p>The path has been switched or timeout occurred in the redundant system.</p> <ul style="list-style-type: none"> • Check the PLC CPU to know if the path has been switched. • Check the cable connection status and the PLC CPU status. <p>This error may occur when the load of the PLC CPU becomes heavier when accessing other stations. In such a case, transfer the data of the other stations to the host station PLC CPU and monitor them at the host.</p> <ul style="list-style-type: none"> • Perform one of the following operations if the PLC scanning time is long: COM instruction/Extension of END processing/Setting of the number of processing times for general data/Data update batch processing. 	○
451	Q redundant system settings and current config. do not match.	<p>Change the Q redundant setting in accordance with the actual Q redundant CPU system.</p>	○
460	Communication unit error	<ul style="list-style-type: none"> • Reset the power of the GOT. • Replace the unit. 	○

Error code	Error message	Action	Channel No. storage
480	Communication channel not set. Set channel number on Utility.	Channel (CH.No.1 to 2) to communicate with a controller is not set. • After setting the Communication Settings on the GT Designer3, download it to the GOT. • Change the channel assignment in the Communication Setting on the utility.	○*1
487	Please turn on the PLC and the GOT again.	Turn the power of the PLC and GOT on again.	○
489	Inactive channel has been selected at Communication Settings.	Inactive channel No. has been set in the project data. • Check whether any unnecessary channel No. has been set in the project data. • Check whether channel Nos. set in the project data are set in the Communication Settings.	○*1
500	Warning! Built-in battery voltage is low.	The voltage of the GOT built-in battery is decreased. Replace the GOT built-in battery.	×
510	Clock data input out of range	The value that is input as clock data is out of the input enabled range. In this case, the input value is not accepted. Confirm the input range of the value to be input as clock data, and input the proper value again.	×
520	Insufficient Flash ROM capacity	The capacity for the buffering area is insufficient in the build in flash memory • Confirm whether there are no mistakes in specified buffering area size.	×
521	Insufficient user memory (RAM) capacity	The capacity for the buffering area is insufficient in the user memory (RAM) • Confirm whether there are no mistakes in specified buffering area size.	×
522	Unnecessary file deleted to create new file.	The old file of different contents has been deleted and a new file has been created. Note that the old file is deleted and the new file is created if the file of the same name with different contents exists when creating files.	×
524	Device writing error. Correct device.	Error occurred while writing in the device. Correct the device.	×
525	Unable to read/write alarm log files under different projects.	Unable to read the alarm log file saved by the different project. Confirm where to store the alarm log file and alarm log file.	×
526	File conversion failed.	The file specified for the file conversion does not exist. Check the settings for specifying a file to be converted.	×
528	Error in SRAM. Failed to write data.	The error may be caused by a failure in the GOT main unit. Please consult your local Mitsubishi (Electric System) Service center or representative.	×
529	Data error in SRAM. Check the battery life.	Error in SRAM data due to battery voltage low, etc. Confirm the battery status.	×
530	Improper monitor device. Confirm monitor channel.	The channel of the specified monitor target does not exist or the channel is not the monitor target. Confirm the monitor target channel of the screen data.	×
535	Cannot open image file.	Confirm whether any file exists in the SD card or USB memory.	×
536	Image file error or invalid file format.	• Confirm whether image files in the SD card or USB memory are normal. • Confirm whether any image file of invalid format is stored.	×

Error code	Error message	Action	Channel No. storage
540	Auto repeat error. Confirm system information.	Error occurred while executing the auto repeat function of the touch switch object. Confirm the following. <ul style="list-style-type: none"> • Confirm that the other system error has not occurred during auto repeat. • Confirm that any error information is not stored in the system information/GS during auto repeat. 	×
570	Recipe device points too large.	The number of the set points of the recipe device exceeds the specified range. Put the number of the set points of the recipe device within the specified range.	×
571	Capacity shortage of user memory (RAM)	There is no empty area/space in D drive. Format the D drive in the memory to secure free area.	×
581	Abnormal Advanced recipe file	Advanced Recipe cannot be executed for advanced recipe file with incorrect contents. Delete the advanced recipe file from the SD card or USB memory.	×
582	Cannot generate Advanced recipe file.	Cannot generate advanced recipe file. Confirm the following and execute recipe processing again. <ul style="list-style-type: none"> • Confirm whether the SD card or USB memory is installed. • Confirm whether the SD card access switch of the GOT is ON. • Confirm the available memory of the SD card or USB memory. 	×
583	Unable to save device value to Advanced recipe file.	Unable to save device value to advanced recipe file. <ul style="list-style-type: none"> • Confirm the write-protection of the SD card or USB memory. • Confirm whether the attribute of saving file is for reading only. 	×
584	Advance recipe file save error	An error has occurred during the advanced recipe file writing. Do not pull out the SD card or USB memory while the Advanced Recipe is operating.	×
585	Advanced recipe file upload error	An error has occurred during the advanced recipe file reading. Do not pull out the SD card or USB memory while the Advanced Recipe is operating.	×
586	Specified Advanced recipe number does not exist.	The advanced recipe of non-existing number is about to be executed. Execute advanced recipe of existing number.	×
587	Specified record number does not exist.	The advanced record of non-existing number is about to be executed. Execute record of existing number.	×
588	Cannot save recipe data to read only record.	Saving recipe is about to be executed to the record of which recipe device value cannot be edited. Make the recipe device value of the record editable with Advanced Recipe Setting of GT Designer3 or specify the record of which recipe device value can be edited.	×
589	Recipe device save error. Recipe file does not exist.	Saving recipe is about to be executed to the advanced recipe setting that is set for not using file. Specify the advanced recipe setting that uses file.	×
590	Recipe device upload error. Recipe device value does not exist.	Loading recipe is about to be executed to the record of which recipe device value is not set. Specify the record of which recipe device value is set.	×
591	Advanced Recipe error. Check recipe data.	The advanced recipe setting is not correct. Confirm the advanced recipe setting of the project data and download it to the GOT again.	×
595	Logging file error.	Logging file error. When collecting data again, delete logging files and management files.	×

Error code	Error message	Action	Channel No. storage
596	Logging setting does not exist or setting value error.	The logging setting specified in the historical trend graph setting does not exist. Review the historical trend graph setting and specify a logging setting that exists.	×
605	USB device I/F error	The error may be caused by a failure in the GOT. Please consult your local Mitsubishi (Electric System) Service center or representative.	×
611	Improper job files. Confirm job setting.	The contents for job files are unmatched with the settings for job files. Check if there are mistakes in the settings on the setting screen.	×
612	Cannot access Logging Files Check the memory card	<ul style="list-style-type: none"> • Insert a SD card or USB memory. • Turn on the SD card access switch. • If the SD card or USB memory have unnecessary files, delete the files. 	×
613	Error in writing logfile	<ul style="list-style-type: none"> • Insert a SD card or USB memory. • Turn on the SD card access switch. • Check if the SD card or USB memory is writable. 	×
614	Error in reading logfile	<ul style="list-style-type: none"> • Insert a SD card or USB memory. • Turn on the SD card access switch. • Check if the SD card or USB memory is readable. 	×
615	Cannot connect to MES Server. Check the Server.	The server does not work normally or the connection path to the server is made up incorrectly. <ul style="list-style-type: none"> • Check the operating conditions of the server. • Check the network to the server. 	×
616	Cannot connect to SNTP Server. Check the Server.	The settings for the SNTP server are wrong or the network to the SNTP server is made up incorrectly. <ul style="list-style-type: none"> • Check the operating conditions of the STNP server. • Check the network to the SNTP server. 	×
640	An error occurred in a FTP client process.	Reconfigure the GOT (FTP client) setting. Check the operating status and network line of the FTP server. For the error details, check the GOT special register GS989 (FTP communication error notification).	×
800	Abnormal module status	Refer to explanations of SB0020 on the applicable network manual.	○
801	Abnormal baton passing status	Refer to explanations of SB0047 on the applicable network manual.	○
802	Abnormal cyclic transmission status	Refer to explanations of SB0049 on the applicable network manual.	○
803	Transient error	Refer to explanations of SB00EE on the applicable network manual.	○
850	CC-Link switch setting error	<ul style="list-style-type: none"> • Check if the switch settings have no error. • Check error codes stored in SW006A. • Refer to explanations of SB006A on the applicable network manual 	○
851	Abnormal cyclic transmission status	<ul style="list-style-type: none"> • Check if terminating resistors are connected. • Check error codes for the PLC CPU. • Check the parameter for the PLC CPU on the master station. • Check the error status of the master station. • Refer to explanations of SB006E on the applicable network manual. 	○
852	Abnormal host line status	<ul style="list-style-type: none"> • Check if the cable is unplugged or not. • Refer to explanations of SB0090 on the applicable network manual. 	○
853	Transient error	<ul style="list-style-type: none"> • Check the transient error occurrence status for each station stored in SW0094 to SW0097. • Refer to explanations of SB0094. 	○

*1 When an error occurs, "FFH" is stored to the channel No.

APPENDICES

Appendix.1 External Dimensions

External dimensions of GT14

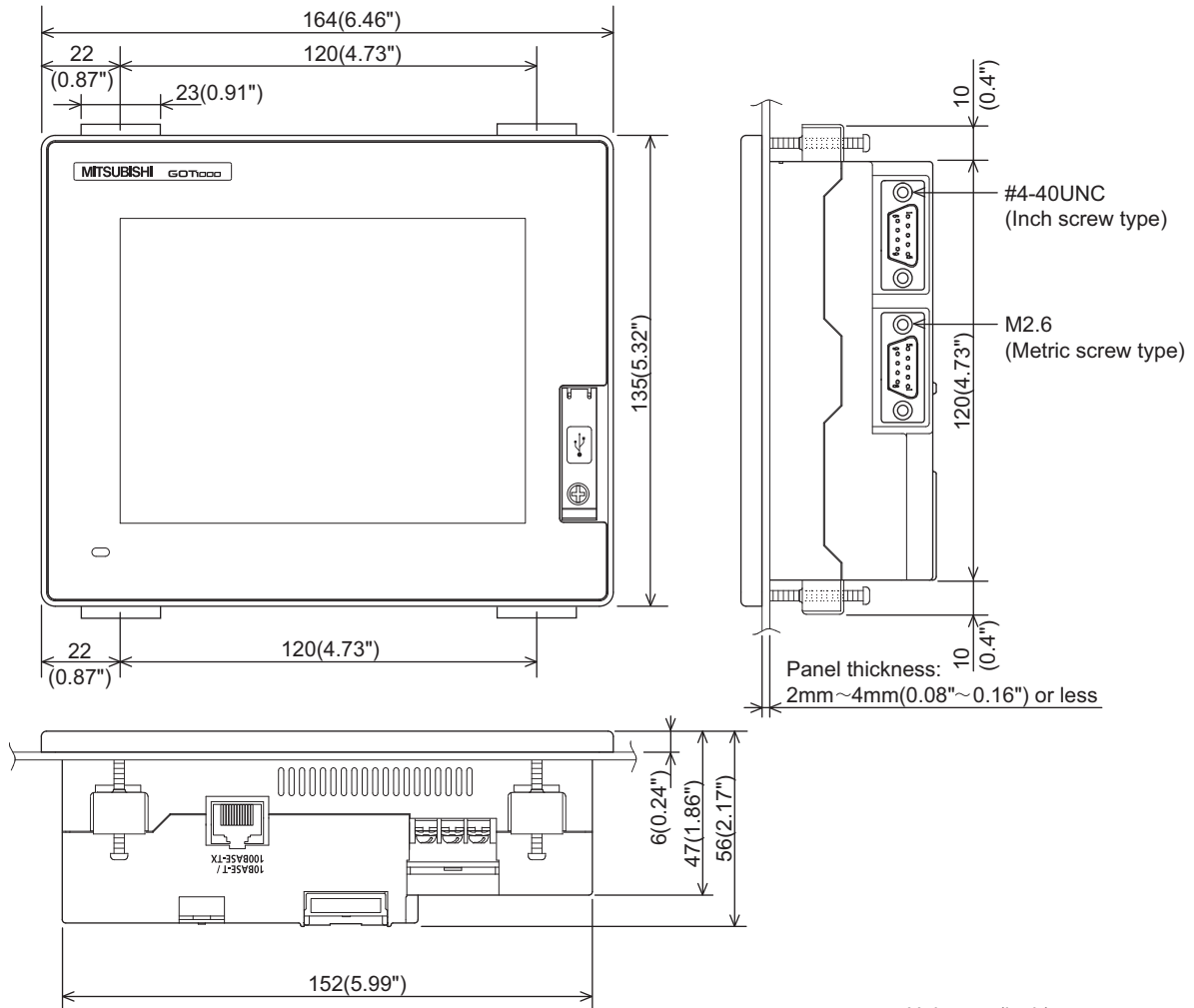

External dimensions of stand

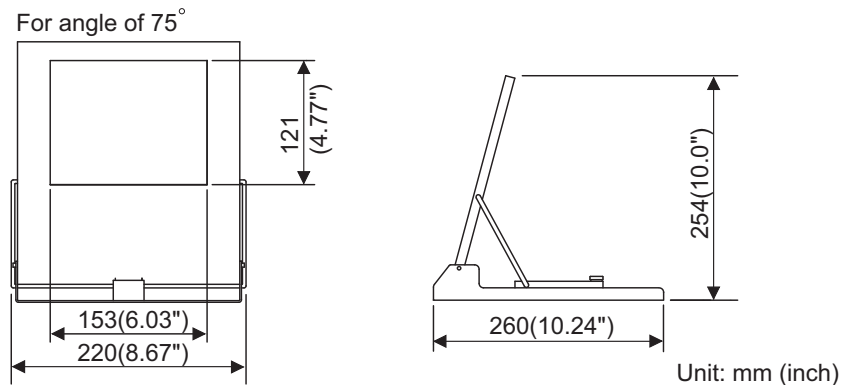

■ External dimensions of serial multi-drop connection unit

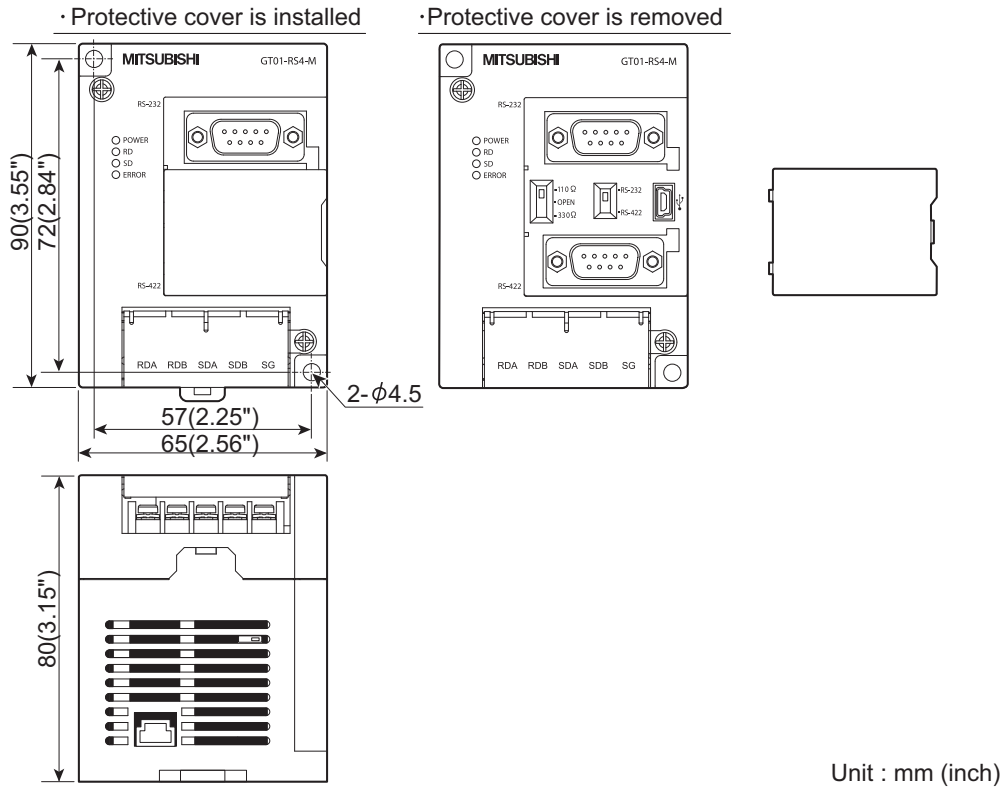

■ External dimensions of connector conversion adapter

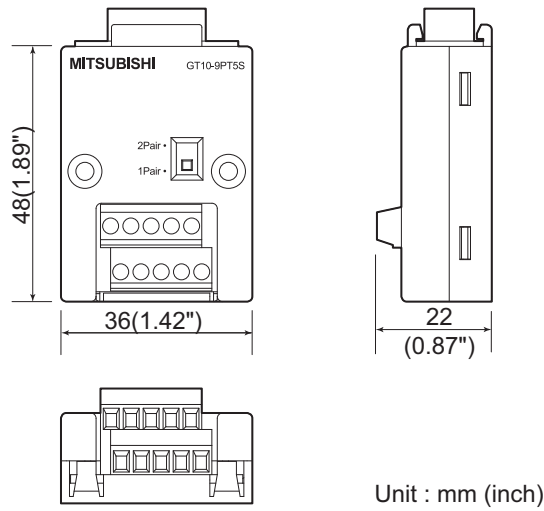

■ External dimensions of RS-232/485 signal conversion adapter

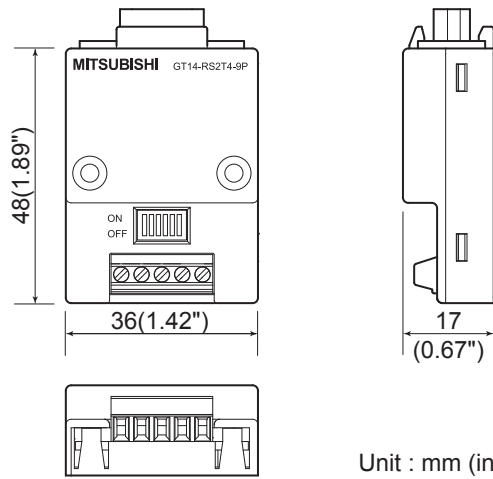

Unit : mm (inch)

■ External dimensions of communication cable

GT01-C30R4-25P

Unit: mm (inch)

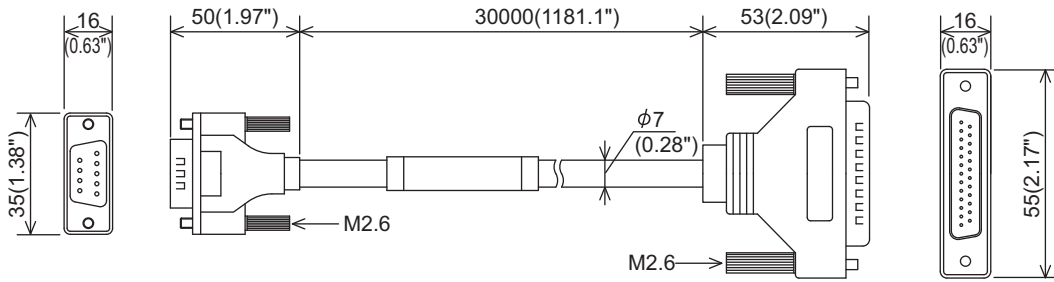

GT01-C□□□R4-25P

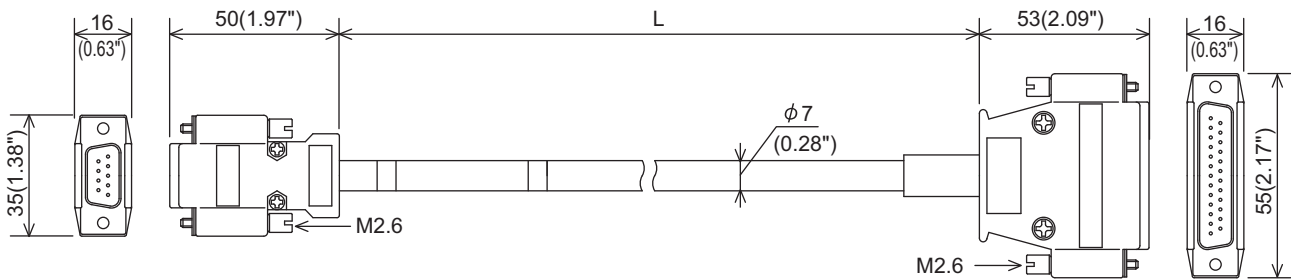

Value of □□□	Length L mm (inch)
100	10000
200	20000
300	30000

GT01-C□□□R4-8P

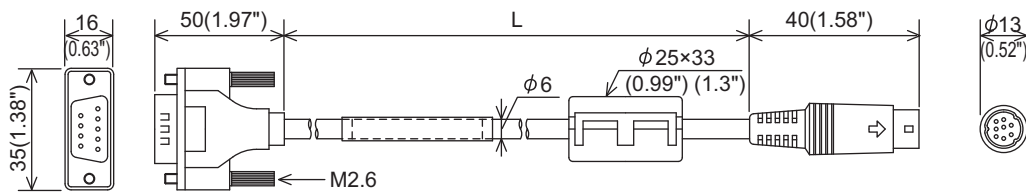

Value of □□□	Length L mm (inch)
10	1000
30	3000
100	10000
200	20000
300	30000

GT01-C30R2-25P

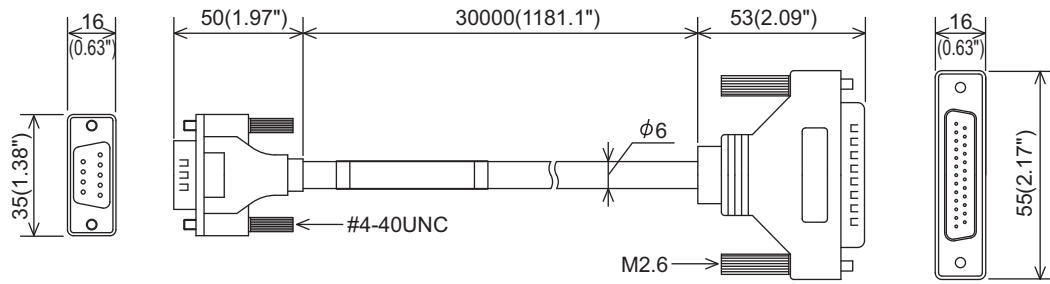

GT01-C30R2-9S

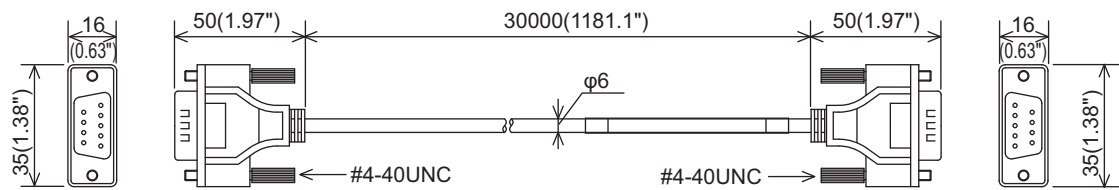

GT01-C30R2-6P

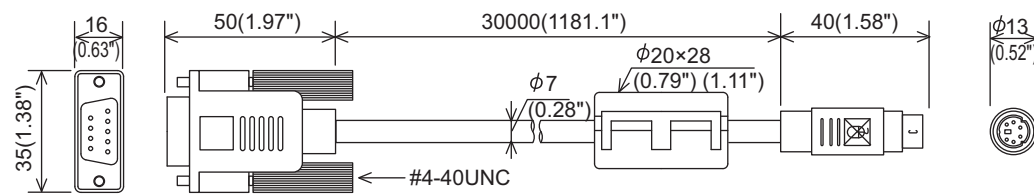

Appendix.2 Usage Condition of Utility Function

The function which can be used differs according to the GOT type.

Moreover, there are the function which can be set with drawing software and the function which cannot be set.

○: Applicable ×: Not applicable -: Not required

Item		Functions overview	GT14	GT11	Drawing Setting
Communication setting	Communication setting	Assigning channel numbers and communication drivers to communication interfaces	○	○	○
		Setting communication parameters	○	○	○
		Setting or deleting sequence program protection key words, canceling sequence program protection status (When connecting to FX series CPU)	○	○	×
	Ethernet setting	Displaying the contents of Ethernet setting, changing the host	○	×	○
GOT setup	Display	Switching message languages	○	○	○
		Setting the startup screen display time and screen saving time	○	○	○
		Setting the backlight to ON or OFF during screen saving	○	○	○
		Setting the battery alarm display to ON or OFF	○	○	○
		Adjusting brightness and contrast	○	○	×
		Inverting colors	○	○	×
	Operation	Setting the buzzer volume and window move buzzer	○	○	○
		Setting the key sensitivity and key reaction speed	○	○	×
		Changing security levels	○	○	×
		Setting the utility call keys	○	○	○
		Adjusting the touch panel	○	○	×
		Setting the USB mouse and keyboard	○	×	×
	Transparent mode	Setting the channel No. to be used for the communication for the FA transparent function	○	×	○
	Backup/restoration	Setting the storage locations for backup data and backup settings, and setting the maximum number of backup data	○	×	○
		Trigger backup settings			
		Setting the CPU No. setting at backup to "YES" or "NO"			
Behavior of duplicate IPs	Setting the GOT operation when a device with the same IP address as that of the GOT is added to the network afterwards	○	×	×	
Program/ data control	OS information	Installing or uploading OS, displaying OS property, checking OS data	○	○	×
	Alarm information	Deleting or copying alarm log files	○	○	×
		Converting alarm log files in G1A format → CSV or TXT format	○	×	×
	Project information	Downloading, uploading, deleting or copying project files, displaying project file property, checking project file data	○	○	×
	Hard copy information	Deleting or copying hard copy files, changing hard copy file names	○	×	×
	Advanced Recipe information	Converting advanced recipe files in G1P format → CSV or TXT format Converting advanced recipe files in CSV or TXT format → G1P format Deleting, copying or moving advanced recipe files, creating a new advanced recipe file	○	×	×
		Deleting or moving advanced recipe folders, changing advanced recipe folder names, creating a new advanced recipe folder			
		Writing, reading or matching record data and deleting device values with the advanced recipe record list			
		Converting logging files in G1L format → CSV or TXT format			
	Logging information	Deleting, copying or moving logging files, changing logging file names Deleting logging folders or creating a new logging folder	○	×	×
		Memory card format	○	○	×
		Memory information	○	○	×
	USB device status display	Displaying the status of USB device	○	×	×
SRAM control	Back up, restoring and initializing of the SRAM user area	○	×	×	
GOT data package acquisition	Copying the OS, special data, and project data to a CF card or USB memory	○	○	×	

○: Applicable ×: Not applicable -: Not required

Item		Functions overview	GT14	GT11	Drawing Setting
Time setting & display		Selecting a base clock	○	○	○
		Displaying and setting the clock current time	○	○	×
		Displaying the battery status	○	○	×
Debug & self check	Debug	System monitor	○	○	×
		FX list editor	○	○	×
		A list editor	○	○	×
		Backup/restoration	○	×	○
	Self check	Memory check	○	○	×
		Drawing check	○	○	×
		Font check	○	○	×
		Touch panel check	○	○	×
		I/O check	○	○	×
		Ethernet status check	○	×	×
	System alarm display	Displaying error code and error message	○	○	×
GOT start time	Displaying GOT start date and time, current time, accumulated operating hours	○	○	×	
Clean	Displaying the screen for cleaning the display	○	○	×	

Appendix.3 Transportation Precautions

When transporting lithium batteries, make sure to treat them based on the transport regulations.

Appendix.3.1 Relevant models

The battery for the GOT1000 series is classified as shown in the table below.

Product name	Model name	Description	Handled as
Battery for GOT1000 series	GT11-50BAT	Lithium battery	Non-dangerous goods

Appendix.3.2 Transportation guidelines

Products are packed properly in compliance with the transportation regulations prior to shipment. When repacking any of the unpacked products to transport it to another location, make sure to observe the IATA Dangerous Goods Regulations, IMDG Code and other local transportation regulations. For details, please consult your transportation company.

INDEX

- [A]
 - A list editor 14-1
 - ABBREVIATIONS AND GENERIC TERMS A-15
 - Adjusting the touch panel position 11-13
 - Advanced recipe information 13-33
 - Alarm information 13-11

- [B]
 - Backlight Shutoff Detection 17-7
 - Backup/restoration 14-2
 - Backup/Restoration Setting 11-18
 - Battery 8-4, 17-4
 - Battery alarm display 11-1, 11-4
 - Behavior of Duplicate IPs 11-21
 - BootOS 16-1
 - Brightness, contrast 11-1, 11-5
 - Buzzer volume setting 11-6, 11-8

- [C]
 - Clean 15-1, 17-3
 - Cleaning of display section 15-1
 - Communication Detail Setting 10-8
 - Communication setting 10-1
 - Connector Conversion Adapter 8-11
 - CoreOS 16-11

- [D]
 - Daily Inspection 17-2
 - Data type and storage location 13-1
 - Debug 14-1
 - Display Setting 11-1
 - Drawing check 14-6

- [E]
 - Error Message 18-11, 18-13
 - Ethernet Setting 10-15
 - Ethernet status check 14-17
 - External Dimensions App-1

- [F]
 - FILE DISPLAY AND COPY 13-1
 - Font check 14-10
 - FX list editor 14-1

- [G]
 - GOT data package acquisition 13-73
 - GOT internal battery voltage status 12-3
 - GOT Restoration Sheet 18-1
 - GOT start time 14-21

- [H]
 - Hard copy information 13-27

- [I]
 - I/O check 14-14
 - INSTALLATION 6-1

- [K]
 - Key sensitivity setting 11-6, 11-8

- [L]
 - Language 11-1, 11-3
 - Logging information 13-53

- [M]
 - MAINTENANCE AND INSPECTION 17-1
 - Memory card format 13-63
 - Memory check 14-3
 - Memory information 13-65

- [O]
 - Opening screen time 11-1, 11-4
 - OS information 13-5
 - OS version confirmation 13-3

- [P]
 - Panel Cutting Dimension 6-2
 - Panel-Mounted USB Port Extension 8-14
 - PARTS NAME 4-1
 - Back Panel 4-2
 - Front Panel 4-1
 - Rear Face 4-3
 - Periodic Inspection 17-2
 - Project Information 13-17
 - Protective Cover for Oil 8-7
 - Protective Sheet 8-6

- [R]
 - RS-232/485 signal conversion adapter 8-16

- [S]
 - Screen save backlight 11-1, 11-4
 - Screen save time 11-1, 11-4
 - SD Card 8-1
 - Security level change 11-9
 - Self Check 14-3
 - Serial Multi-Drop Connection Unit 8-12
 - SPECIFICATIONS 3-1
 - General Specifications 3-1
 - Performance Specifications 3-2
 - Power Supply Specifications 3-3
 - SRAM control 13-68
 - Stand 8-10
 - Standard monitor OS 16-1
 - System Alarm 18-11, 18-13
 - System Alarm Display 14-19

SYSTEM CONFIGURATION.....	2-1
Overall Configuration	2-1
System Equipment.....	2-1
System monitor.....	14-1

[T]

Time Setting and Display.....	12-1
Clock display	12-3
Clock setting.....	12-2
Touch panel check	14-12
Transparent Mode Setting	11-17
Transportation Precautions	App-9
TROUBLESHOOTING	18-1

[U]

UL, cUL STANDARDS AND EMC DIRECTIVE.....	5-1
USB device status display	13-66
USB Environmental Protection Cover.....	8-9
USB memory	8-3
USB mouse/keyboard setting	11-15
Utility Call Key Setting	11-11
UTILITY FUNCTION.....	9-1, App-7
Display	9-4
Function List.....	9-2

[W]

Window move buzzer volume setting	11-6, 11-8
WIRING	7-1
Power Supply Wiring.....	7-2
Wiring inside.....	7-5
Wiring outside	7-5

WARRANTY

Please confirm the following product warranty details before using this product.

1. Gratis Warranty Term and Gratis Warranty Range

If any faults or defects (hereinafter "Failure") found to be the responsibility of Mitsubishi occurs during use of the product within the gratis warranty term, the product shall be repaired at no cost via the sales representative or Mitsubishi Service Company. However, if repairs are required onsite at domestic or overseas location, expenses to send an engineer will be solely at the customer's discretion. Mitsubishi shall not be held responsible for any re-commissioning, maintenance, or testing on-site that involves replacement of the failed module.

[Gratis Warranty Term]

The gratis warranty term of the product shall be for thirty-six (36) months after the date of purchase or delivery to a designated place.

Note that after manufacture and shipment from Mitsubishi, the maximum distribution period shall be six (6) months, and the longest gratis warranty term after manufacturing shall be forty-two (42) months. The gratis warranty term of repair parts shall not exceed the gratis warranty term before repairs.

[Gratis Warranty Range]

- (1) The customer shall be responsible for the primary failure diagnosis unless otherwise specified.
If requested by the customer, Mitsubishi Electric Corporation or its representative firm may carry out the primary failure diagnosis at the customer's expense.
The primary failure diagnosis will, however, be free of charge should the cause of failure be attributable to Mitsubishi Electric Corporation.
- (2) The range shall be limited to normal use within the usage state, usage methods and usage environment, etc., which follow the conditions and precautions, etc., given in the instruction manual, user's manual and caution labels on the product.
- (3) Even within the gratis warranty term, repairs shall be charged for in the following cases.
 1. Failure occurring from inappropriate storage or handling, carelessness or negligence by the user. Failure caused by the user's hardware or software design.
 2. Failure caused by unapproved modifications, etc., to the product by the user.
 3. When the Mitsubishi product is assembled into a user's device, Failure that could have been avoided if functions or structures, judged as necessary in the legal safety measures the user's device is subject to or as necessary by industry standards, had been provided.
 4. Failure that could have been avoided if consumable parts designated in the instruction manual had been correctly serviced or replaced.
 5. Replacing consumable parts such as the battery, backlight and fuses.
 6. Failure caused by external irresistible forces such as fires or abnormal voltages, and Failure caused by force majeure such as earthquakes, lightning, wind and water damage.
 7. Failure caused by reasons unpredictable by scientific technology standards at time of shipment from Mitsubishi.
 8. Any other failure found not to be the responsibility of Mitsubishi or that admitted not to be so by the user.

2. Onerous repair term after discontinuation of production

- (1) Mitsubishi shall accept onerous product repairs for seven (7) years after production of the product is discontinued.
Discontinuation of production shall be notified with Mitsubishi Technical Bulletins, etc.
- (2) Product supply (including repair parts) is not available after production is discontinued.

3. Overseas service

Overseas, repairs shall be accepted by Mitsubishi's local overseas FA Center. Note that the repair conditions at each FA Center may differ.

4. Exclusion of loss in opportunity and secondary loss from warranty liability

Regardless of the gratis warranty term, Mitsubishi shall not be liable for compensation to damages caused by any cause found not to be the responsibility of Mitsubishi, loss in opportunity, lost profits incurred to the user by Failures of Mitsubishi products, special damages and secondary damages whether foreseeable or not, compensation for accidents, and compensation for damages to products other than Mitsubishi products, replacement by the user, maintenance of on-site equipment, start-up test run and other tasks.

5. Changes in product specifications

The specifications given in the catalogs, manuals or technical documents are subject to change without prior notice.

6. Product application

- (1) In using the Mitsubishi graphic operation terminal, the usage conditions shall be that the application will not lead to a major accident even if any problem or fault should occur in the graphic operation terminal device, and that backup and fail-safe functions are systematically provided outside of the device for any problem or fault.
- (2) The Mitsubishi graphic operation terminal has been designed and manufactured for applications in general industries, etc. Thus, applications in which the public could be affected such as in nuclear power plants and other power plants operated by respective power companies, and applications in which a special quality assurance system is required, such as for Railway companies or Public service purposes shall be excluded from the graphic operation terminal applications.
In addition, applications in which human life or property that could be greatly affected, such as in aircraft, medical applications, incineration and fuel devices, manned transportation equipment for recreation and amusement, and safety devices, shall also be excluded from the graphic operation terminal range of applications.
However, in certain cases, some applications may be possible, providing the user consults the local Mitsubishi representative outlining the special requirements of the project, and providing that all parties concerned agree to the special circumstances, solely at our discretion.
In some of three cases, however, Mitsubishi Electric Corporation may consider the possibility of an application, provided that the customer notifies Mitsubishi Electric Corporation of the intention, the application is clearly defined and any special quality is not required.

GOT is a registered trademark of Mitsubishi Electric Corporation.

Microsoft, Windows, Windows NT, Windows Server, Windows Vista, and Windows 7 are registered trademarks or trademarks of Microsoft Corporation in the United States and other countries.

Adobe and Adobe Reader are registered trademarks of Adobe Systems Incorporated.

Pentium and Celeron are a registered trademarks of Intel Corporation in the United States and other countries.

Ethernet is a trademark of Xerox Corporation in the United States.

MODBUS is a trademark of Schneider Electric SA.

VNC is a registered trademark of RealVNC Ltd. in the United States and other countries.

Other company and product names herein are either trademarks or registered trademarks of their respective owners.

GRAPHIC OPERATION TERMINAL

GOT1000

GT14 User's Manual

MODEL	GT14-U-E
MODEL CODE	09R823
JY997D44801F	

 **MITSUBISHI ELECTRIC CORPORATION**

HEAD OFFICE : TOKYO BUILDING, 2-7-3 MARUNOUCHI, CHIYODA-KU, TOKYO 100-8310, JAPAN
HIMEJI WORKS : 840, CHIYODA CHO, HIMEJI, JAPAN

When exported from Japan, this manual does not require application to the Ministry of Economy, Trade and Industry for service transaction permission.

Specifications are subject to change without notice.

HEADQUARTERS

MITSUBISHI ELECTRIC EUROPE B.V. **EUROPE**
 German Branch
 Gothaer Straße 8
D-40880 Ratingen
 Phone: +49 (0)2102 / 486-0
 Fax: +49 (0)2102 / 486-1120

MITSUBISHI ELECTRIC EUROPE B.V.-org.sl. **CZECH REP.**
 Czech Branch
 Avenir Business Park, Radlická 714/113a
CZ-158 00 Praha 5
 Phone: +420 - 251 551 470
 Fax: +420 - 251-551-471

MITSUBISHI ELECTRIC EUROPE B.V. **FRANCE**
 French Branch
 25, Boulevard des Bouvets
F-92741 Nanterre Cedex
 Phone: +33 (0)1 / 55 68 55 68
 Fax: +33 (0)1 / 55 68 57 57

MITSUBISHI ELECTRIC EUROPE B.V. **IRELAND**
 Irish Branch
 Westgate Business Park, Ballymount
IRL-Dublin 24
 Phone: +353 (0)1 4198800
 Fax: +353 (0)1 4198890

MITSUBISHI ELECTRIC EUROPE B.V. **ITALY**
 Italian Branch
 Viale Colleoni 7
I-20041 Agrate Brianza (MB)
 Phone: +39 039 / 60 53 1
 Fax: +39 039 / 60 53 312

MITSUBISHI ELECTRIC EUROPE B.V. **POLAND**
 Poland Branch
 Krakowska 50
PL-32-083 Balice
 Phone: +48 (0)12 / 630 47 00
 Fax: +48 (0)12 / 630 47 01

MITSUBISHI ELECTRIC EUROPE B.V. **RUSSIA**
 52, bid. 3 Kosmodamianskaya nab 8 floor
RU-115054 Moscow
 Phone: +7 495 721-2070
 Fax: +7 495 721-2071

MITSUBISHI ELECTRIC EUROPE B.V. **SPAIN**
 Spanish Branch
 Carretera de Rubí 76-80
E-08190 Sant Cugat del Vallés (Barcelona)
 Phone: 902 131121 // +34 935653131
 Fax: +34 935891579

MITSUBISHI ELECTRIC EUROPE B.V. **UK**
 UK Branch
 Travellers Lane
UK-Hatfield, Herts. AL10 8XB
 Phone: +44 (0)1707 / 27 61 00
 Fax: +44 (0)1707 / 27 86 95

MITSUBISHI ELECTRIC CORPORATION **JAPAN**
 Office Tower "Z" 14 F
 8-12,1 chome, Harumi Chuo-Ku
Tokyo 104-6212
 Phone: +81 3 622 160 60
 Fax: +81 3 622 160 75

MITSUBISHI ELECTRIC AUTOMATION, Inc. **USA**
 500 Corporate Woods Parkway
Vernon Hills, IL 60061
 Phone: +1 847 478 21 00
 Fax: +1 847 478 22 53

EUROPEAN REPRESENTATIVES

GEVA **AUSTRIA**
 Wiener Straße 89
AT-2500 Baden
 Phone: +43 (0)2252 / 85 55 20
 Fax: +43 (0)2252 / 488 60

TECHNIKON **BELARUS**
 Oktyabrskaya 19, Off. 705
BY-220030 Minsk
 Phone: +375 (0)17 / 210 46 26
 Fax: +375 (0)17 / 210 46 26

ESCO DRIVES & AUTOMATION **BELGIUM**
 Culliganlaan 3
BE-1831 Diegem
 Phone: +32 (0)2 / 717 64 30
 Fax: +32 (0)2 / 717 64 31

Koning & Hartman b.v. **BELGIUM**
 Woluwelaan 31
BE-1800 Vilvoorde
 Phone: +32 (0)2 / 257 02 40
 Fax: +32 (0)2 / 257 02 49

INEA RBT d.o.o. **BOSNIA AND HERZEGOVINA**
 Aleja Lipa 56
BA-71000 Sarajevo
 Phone: +387 (0)33 / 921 164
 Fax: +387 (0)33 / 524 539

AKHNATON **BULGARIA**
 4, Andrej Ljapchev Blvd., PO Box 21
BG-1756 Sofia
 Phone: +359 (0)2 / 817 6000
 Fax: +359 (0)2 / 97 44 06 1

INEA RBT d.o.o. **CROATIA**
 Losinjska 4 a
HR-10000 Zagreb
 Phone: +385 (0)1 / 36 940 -01 / -02 / -03
 Fax: +385 (0)1 / 36 940 -03

AutoCont C.S. s.r.o. **CZECH REPUBLIC**
 Technologická 374/6
CZ-708 00 Ostrava-Pustkovce
 Phone: +420 595 691 150
 Fax: +420 595 691 199

Beijer Electronics A/S **DENMARK**
 Lykkegårdsvej 17
DK-4000 Roskilde
 Phone: +45 (0)46 / 75 76 66
 Fax: +45 (0)46 / 75 56 26

Beijer Electronics Eesti OÜ **ESTONIA**
 Pärnu mnt.160i
EE-11317 Tallinn
 Phone: +372 (0)6 / 51 81 40
 Fax: +372 (0)6 / 51 81 49

Beijer Electronics OY **FINLAND**
 Peltoie 37
FIN-28400 Ulvila
 Phone: +358 (0)207 / 463 540
 Fax: +358 (0)207 / 463 541

UTEKO **GREECE**
 5, Mavrogenous Str.
GR-18542 Piraeus
 Phone: +30 211 / 1206 900
 Fax: +30 211 / 1206 999

MELTRADE Kft. **HUNGARY**
 Fertő utca 14.
HU-1107 Budapest
 Phone: +36 (0)1 / 431-9726
 Fax: +36 (0)1 / 431-9727

Beijer Electronics SIA **LATVIA**
 Ritausmas iela 23
LV-1058 Riga
 Phone: +371 (0)784 / 2280
 Fax: +371 (0)784 / 2281

Beijer Electronics UAB **LITHUANIA**
 Savanoriu Pr. 187
LT-02300 Vilnius
 Phone: +370 (0)5 / 232 3101
 Fax: +370 (0)5 / 232 2980

EUROPEAN REPRESENTATIVES

ALFATRADE Ltd. **MALTA**
 99, Paola Hill
Malta- Paola PLA 1702
 Phone: +356 (0)21 / 697 816
 Fax: +356 (0)21 / 697 817

INTEHSIS srl **MOLDOVA**
 bld. Traian 23/1
MD-2060 Kishinev
 Phone: +373 (0)22 / 66 4242
 Fax: +373 (0)22 / 66 4280

HIFLEX AUTOM.TECHNIEK B.V. **NETHERLANDS**
 Wolweverstraat 22
NL-2984 CD Ridderkerk
 Phone: +31 (0)180 - 46 60 04
 Fax: +31 (0)180 - 44 23 55

Koning & Hartman b.v. **NETHERLANDS**
 Haarlbergweg 21-23
NL-1101 CH Amsterdam
 Phone: +31 (0)20 / 587 76 00
 Fax: +31 (0)20 / 587 76 05

Beijer Electronics AS **NORWAY**
 Postboks 487
NO-3002 Drammen
 Phone: +47 (0)32 / 24 30 00
 Fax: +47 (0)32 / 84 85 77

Fonseca S.A. **PORTUGAL**
 R. João Francisco do Casal 87/89
PT - 3801-997 Aveiro, Esgueira
 Telefono: +351 (0)234 / 303 900
 Fax: +351 (0)234 / 303 910

Sirius Trading & Services srl **ROMANIA**
 Aleea Lacul Morii Nr. 3
RO-060841 Bucuresti, Sector 6
 Phone: +40 (0)21 / 430 40 06
 Fax: +40 (0)21 / 430 40 02

INEA RBT d.o.o. **SERBIA**
 Izletnicka 10
SER-113000 Smederevo
 Phone: +381 (0)26 / 615 401
 Fax: +381 (0)26 / 615 401

SIMAP s.r.o. **SLOVAKIA**
 Jána Derku 1671
SK-911 01 Trenčín
 Phone: +421 (0)32 743 04 72
 Fax: +421 (0)32 743 75 20

PROCONT, spol. s r.o. **SLOVAKIA**
 Prešov
 Kúpeľná 1/A
SK-080 01 Prešov
 Phone: +421 (0)51 7580 611
 Fax: +421 (0)51 7580 650

INEA RBT d.o.o. **SLOVENIA**
 Stegne 11
SI-1000 Ljubljana
 Phone: +386 (0)1 / 513 8116
 Fax: +386 (0)1 / 513 8170

Beijer Electronics AB **SWEDEN**
 Box 426
SE-20124 Malmö
 Phone: +46 (0)40 / 35 86 00
 Fax: +46 (0)40 / 93 23 01

Omni Ray AG **SWITZERLAND**
 Im Schörl 5
CH-8600 Dübendorf
 Phone: +41 (0)44 / 802 28 80
 Fax: +41 (0)44 / 802 28 28

GTS **TURKEY**
 Bayraktar Bulvarı Nutuk Sok. No:5
TR-34775 Yukarı Dudullu-Ümraniye-İSTANBUL
 Phone: +90 (0)216 526 39 90
 Fax: +90 (0)216 526 3995

CSC Automation Ltd. **UKRAINE**
 4-B, M. Raskovoyi St.
UA-02660 Kiev
 Phone: +380 (0)44 / 494 33 55
 Fax: +380 (0)44 / 494-33-66

Systemgroup **UKRAINE**
 2 M. Krivonosy St.
UA-03680 Kiev
 Phone: +380 (0)44 / 490 92 29
 Fax: +380 (0)44 / 248 88 68

EURASIAN REPRESENTATIVES

TOO Kazpromavtomatika **KAZAKHSTAN**
 Ul. Zhambyla 28
KAZ-100017 Karaganda
 Phone: +7 7212 / 50 10 00
 Fax: +7 7212 / 50 11 50

MIDDLE EAST REPRESENTATIVES

I.C. SYSTEMS LTD. **EGYPT**
 23 Al-Saad-Al-Alee St.
EG-Sarayat, Maadi, Cairo
 Phone: +20 (0) 2 / 235 98 548
 Fax: +20 (0) 2 / 235 96 625

ILAN & GAVISH Ltd. **ISRAEL**
 24 Shenkar St., Kiryat Arie
IL-49001 Petah-Tiqva
 Phone: +972 (0)3 / 922 18 24
 Fax: +972 (0)3 / 924 0761

CEG INTERNATIONAL **LEBANON**
 Cebaco Center/Block A Autostrade DORA
Lebanon - Beirut
 Phone: +961 (0)1 / 240 430
 Fax: +961 (0)1 / 240 438

AFRICAN REPRESENTATIVE

CBI Ltd. **SOUTH AFRICA**
 Private Bag 2016
ZA-1600 Isando
 Phone: + 27 (0)11 / 977 0770
 Fax: + 27 (0)11 / 977 0761