

# MELSEC A Series

Programmable Controller

User's Manual

## AJ71AT21B MELSECNET/B Data Link Module

## REVISIONS

\*The manual number is given on the bottom left of the back cover.

Print Date	*Manual Number	Revision
Oct., 1991	IB (NA) 66342-A	First edition

## **INTRODUCTION**

Thank you for choosing the Mitsubishi MELSEC-A Series of General Purpose Programmable Controllers. Please read this manual carefully so that the equipment is used to its optimum. A copy of this manual should be forwarded to the end User.

# CONTENTS

<b>1. INTRODUCTION</b>	<b>1-1</b>
<b>2. SPECIFICATIONS</b>	<b>2-1 ~ 2-3</b>
2.1 General Specifications	2-1
2.2 Performance Specifications	2-2
<b>3. HANDLING</b>	<b>3-1 ~ 3-4</b>
3.1 Handling Instructions	3-1
3.2 Part Names	3-2
3.3 Settings of Each Part	3-4
<b>4. SELF-DIAGNOSTIC TESTING</b>	<b>4-1 ~ 4-3</b>
4.1 Self-Loopback Test	4-1
4.2 Inter-Station Testing	4-2
<b>APPENDIX</b>	<b>APP-1</b>
Appendix 1 Outside Dimensions	APP-1

## 1. INTRODUCTION

- (1) This manual describes the specifications, part names, and self-diagnostic tests of the AJ71AT21B.

The AJ71AT21B is used with in a MELSECNET/B data link system.

- (2) The following gives the application, applicable cable, and installation location of the AJ71AT21B:

- Application : As a master or local station
- Applicable cable : Twisted wire pair cable
- Module installation location : I/O slot of a main or extension base unit

- (3) The following manual gives details about the MELSECNET/B data link system:

MELSECNET, MELSECNET/B data link system reference manual

## 2. SPECIFICATIONS

MELSEC-A

### 2. SPECIFICATIONS

This section gives the general specifications of the data link system and the performance specifications of the AJ71AT21B.

#### 2.1 General Specifications

The general specifications of the data link system are given below:

Item	Specifications				
Operating ambient temperature	0 to 55 °C				
Storage ambient temperature	-20 to 75 °C				
Operating ambient humidity	10 to 90% RH, non-condensing				
Storage ambient temperature	10 to 90% RH, non-condensing				
Vibration resistance	Conforms to ** JIS C 0911	Frequency	Acceleration	Amplitude	Sweep Count
		10 to 55 Hz	—	0.075 mm (0.003 in)	10 times *(1 octave/minute)
		55 to 150 Hz	1 G	—	
Shock resistance	Conforms to JIS C 0912 (10g X 3 times in 3 directions)				
Noise durability	By noise simulator of 1500 Vpp voltage, 1 μsec noise width and 25 to 60 Hz noise frequency				
Dielectric withstand voltage	500 VAC for 1 minute across DC external terminals and ground				
Insulation resistance	5 MΩ or greater by 500 VDC insulation resistance tester across AC external terminals and ground				
Operating ambience	Free of corrosive gases. Dust should be minimal.				
Cooling method	Self-cooling				

#### REMARK

One octave marked \* indicates a change from the initial frequency to double or half frequency. For example, any of the changes from 10 to 20 Hz, from 20 to 40 Hz, or 20 to 10 Hz are referred to as one octave.

Note: \*\* JIS: Japanese Industrial Standard

## 2. SPECIFICATIONS

MELSEC-A

### 2.2 Performance Specifications

The performance specifications of the AJ71AT21B are given below:

Item		Specifications	
Model		AJ71AT21B	
Max. number of device points allocated to communication linkage per station		Input (X) Output (Y)	Depends on the Max. number of I/O points of the utilized PC CPU.
MELSECNET mode	Max. link points for one system	B	1024 points (128 byte)
		W	1024 points (2048 byte)
	Max. link points for one station	$\frac{Y(\text{point}) + B(\text{point})}{8} + 2 \times W(\text{point}) \leq 1024 \text{ byte}$	
MELSECNET II mode	Max. link points for one system	B	4096 points (512 byte)
		W	4096 points (8192 byte)
	Max. link points for one station	$\frac{Y(\text{point}) + B(\text{point})}{8} + 2 \times W(\text{point}) \leq 1024 \text{ byte}$ (First half of link parameter) $\frac{B(\text{point})}{8} + 2 \times W(\text{point}) \leq 1024 \text{ byte}$ (Second half of link parameter)	
MELSECNET II Composite mode	Max. link points for one system	B	4096 points (512 byte)
		W	4096 points (8192 byte)
	Max. link points for one station	$\frac{Y(\text{point}) + B(\text{point})}{8} + 2 \times W(\text{point}) \leq 1024 \text{ byte}$ (First half of link parameter) $\frac{B(\text{point})}{8} + 2 \times W(\text{point}) \leq 1024 \text{ byte}$ (Second half of link parameter)	
Current consumption (5 VDC)		0.72 A	
Weight		0.33 kg	
Allowable momentary power failure time		20 msec	
Communication speeds		125K bps/250K bps/500K bps/1M bps	
Communication method		Half duplex bit serial method	
Synchronous method		Frame synchronous method	
Transmission path method		Bus type	
Overall extension distance		Varies according to the communication speed	
Modulation method		NRZI method	
Transmission format		Conforms to HDLC (frame method)	
Error control system		Retry due to CRC (generating polynomial $X^{16} + X^{12} + X^5 + 1$ ) and timeout	
RAS function		Diagnostic function such as host link line	
Connecting terminal		Terminal block	
Applicable cable		Shielded twisted wire pair cable (KNPEV-SB 0.5SQ x 1P)	
Number of occupied I/O points		32 points	

## 2. SPECIFICATIONS

## MELSEC-A

### REMARK

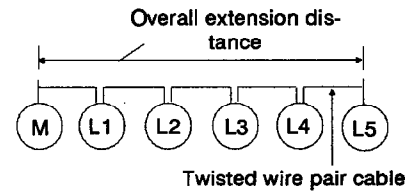

- (1) The overall extension distance is the distance between both end stations in the MELSECNET/B data link system.
- (2) The relationship between communication speeds and the overall extension distance is shown below:

	Communication Speeds			
	125K bps	250K bps	500K bps	1 M bps
Overall extension distance	1200 m	600 m	400 m	200 m



### 3. HANDLING

#### 3.1 Handling Instructions

Handle the AJ71AT21B as indicated below:

- (1) Protect the case from impact, since it is made from resin.
- (2) Do not touch or remove the printed circuit boards from the case.
- (3) When wiring, make every effort to keep wire offcuts from entering the module. Make sure to remove any which do enter the module.
- (4) To install the module to the base unit, tighten the screws as indicated:

Screw Location	Tightening Torque Range (kg-cm)
Cable terminal screw (M3.5 screw)	6 to 9
Terminal block mounting screw (M3.5 screw)	6 to 9
Module mounting screw (M4 screw)	8 to 12

### 3. HANDLING



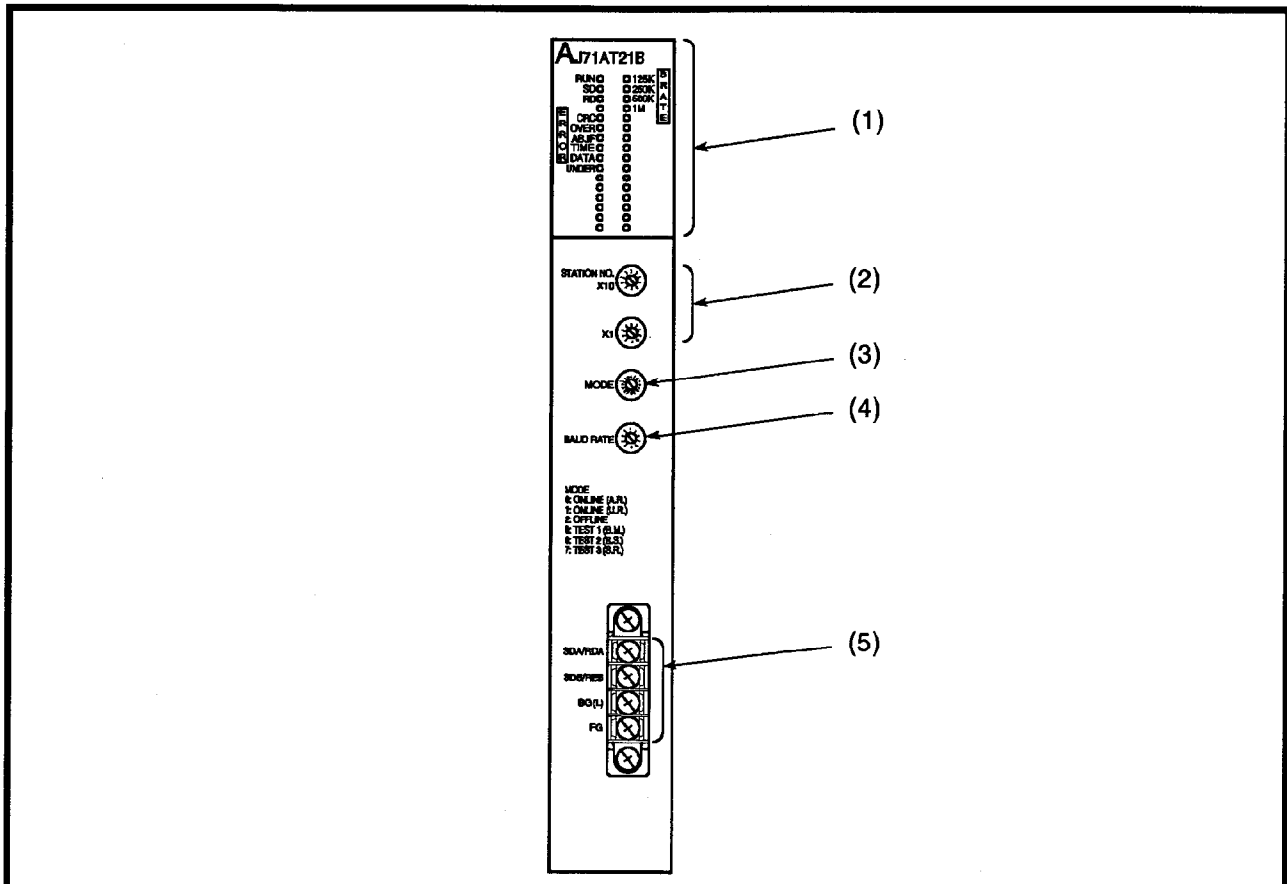

#### 3.2 Part Names

The part names of the AJ71AT21B and their applications are given below:



No.	Name (Enlarged View)	Application																
		LED	Operation	LED	Operation													
(1)	Operation State and Error Indication LED	RUN	Flashes when AJ71AT21B is running	125K	Baud rate setting indication													
	<table border="0"> <tr> <td>RUN ○</td> <td>○ 125K</td> <td rowspan="4">B. RATE</td> </tr> <tr> <td>SD ○</td> <td>○ 250K</td> </tr> <tr> <td>RD ○</td> <td>○ 500K</td> </tr> <tr> <td>○</td> <td>○ 1M</td> </tr> </table>	RUN ○	○ 125K	B. RATE		SD ○	○ 250K	RD ○	○ 500K	○	○ 1M	SD	Flashes during data sending	250K				
		RUN ○	○ 125K			B. RATE												
		SD ○	○ 250K															
		RD ○	○ 500K															
	○	○ 1M																
	RD	Flashes during data receiving	500K															
	○	Not used	1M															
	<table border="0"> <tr> <td rowspan="6">ERROR</td> <td>CRC ○</td> <td>○</td> </tr> <tr> <td>OVER ○</td> <td>○</td> </tr> <tr> <td>AB. IF ○</td> <td>○</td> </tr> <tr> <td>TIME ○</td> <td>○</td> </tr> <tr> <td>DATA ○</td> <td>○</td> </tr> <tr> <td>UNDER ○</td> <td>○</td> </tr> </table>	ERROR	CRC ○	○	OVER ○	○	AB. IF ○	○	TIME ○	○	DATA ○	○	UNDER ○	○	CRC	Flashes during code check error		Not used
			ERROR	CRC ○	○													
				OVER ○	○													
				AB. IF ○	○													
				TIME ○	○													
				DATA ○	○													
UNDER ○	○																	
OVER	Flashes during data delay error																	
AB. IF	Flashes when all data is 1																	
TIME	Flashes during time out error																	
DATA	Flashes during data error																	
UNDER	Flashes during under error																	
	Not used																	

### 3. HANDLING

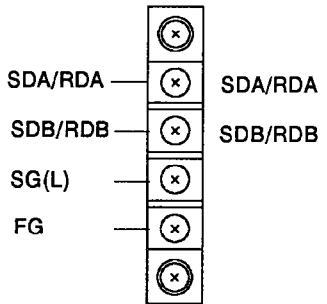
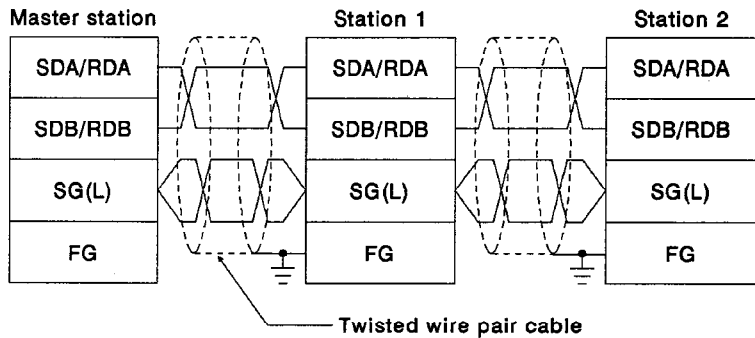
No.	Name (Enlarged View)	Application																											
(2)	Station Number Setting Switch	<ul style="list-style-type: none"> <li>● Set a station number within the range of 00 to 31.</li> <li>● Set the ×10 switch corresponding to the first number of the station.</li> <li>● Set the ×1 switch corresponding to the second number of the station.</li> <li>● When this station is used as the master station, set these switches to 0 and 0.</li> <li>● When this station is used as a local station, set these switches within the range of 01 to 31.</li> </ul>																											
	STATION. NO × 10   × 1 																												
(3)	Mode Selection Switch	<ul style="list-style-type: none"> <li>● The following modes can be selected using the mode selection switch:</li> </ul>																											
	MODE 	<table border="1"> <thead> <tr> <th>Setting Number</th> <th>Name</th> <th>Description</th> </tr> </thead> <tbody> <tr> <td>0</td> <td>Online (A.R)</td> <td>Automatically returns when the module operates normally.</td> </tr> <tr> <td>1</td> <td>Online (U.R)</td> <td>Does not automatically return when the module operates normally.</td> </tr> <tr> <td>2</td> <td>Offline</td> <td>Releases the self station.</td> </tr> <tr> <td>3.4</td> <td>—</td> <td>Unused</td> </tr> <tr> <td>5</td> <td>Test 1 (B.M)</td> <td>Inter-station test mode (master station)</td> </tr> <tr> <td>6</td> <td>Test 2 (B.S)</td> <td>Inter-station test mode (slave station)</td> </tr> <tr> <td>7</td> <td>Test 3 (S.R)</td> <td>Self-loopback test</td> </tr> <tr> <td>8 to F</td> <td>—</td> <td>Unusable</td> </tr> </tbody> </table>	Setting Number	Name	Description	0	Online (A.R)	Automatically returns when the module operates normally.	1	Online (U.R)	Does not automatically return when the module operates normally.	2	Offline	Releases the self station.	3.4	—	Unused	5	Test 1 (B.M)	Inter-station test mode (master station)	6	Test 2 (B.S)	Inter-station test mode (slave station)	7	Test 3 (S.R)	Self-loopback test	8 to F	—	Unusable
		Setting Number	Name	Description																									
		0	Online (A.R)	Automatically returns when the module operates normally.																									
		1	Online (U.R)	Does not automatically return when the module operates normally.																									
		2	Offline	Releases the self station.																									
		3.4	—	Unused																									
		5	Test 1 (B.M)	Inter-station test mode (master station)																									
		6	Test 2 (B.S)	Inter-station test mode (slave station)																									
7	Test 3 (S.R)	Self-loopback test																											
8 to F	—	Unusable																											
BAUD RATE 	<table border="1"> <thead> <tr> <th>Setting Number</th> <th>Baud Rate</th> </tr> </thead> <tbody> <tr> <td>0</td> <td>125K bps</td> </tr> <tr> <td>1</td> <td>250K bps</td> </tr> <tr> <td>2</td> <td>500K bps</td> </tr> <tr> <td>3</td> <td>1M bps</td> </tr> <tr> <td>4 to F</td> <td>Unused*</td> </tr> </tbody> </table>	Setting Number	Baud Rate	0	125K bps	1	250K bps	2	500K bps	3	1M bps	4 to F	Unused*																
	Setting Number	Baud Rate																											
	0	125K bps																											
	1	250K bps																											
	2	500K bps																											
3	1M bps																												
4 to F	Unused*																												
* If the switch is set to any number from 4 to F, the LED (DATA) goes ON and the module goes into the offline state.																													
Terminal Block		<ul style="list-style-type: none"> <li>● How to wire the stations is shown in the POINT below *1:</li> </ul>																											
																													

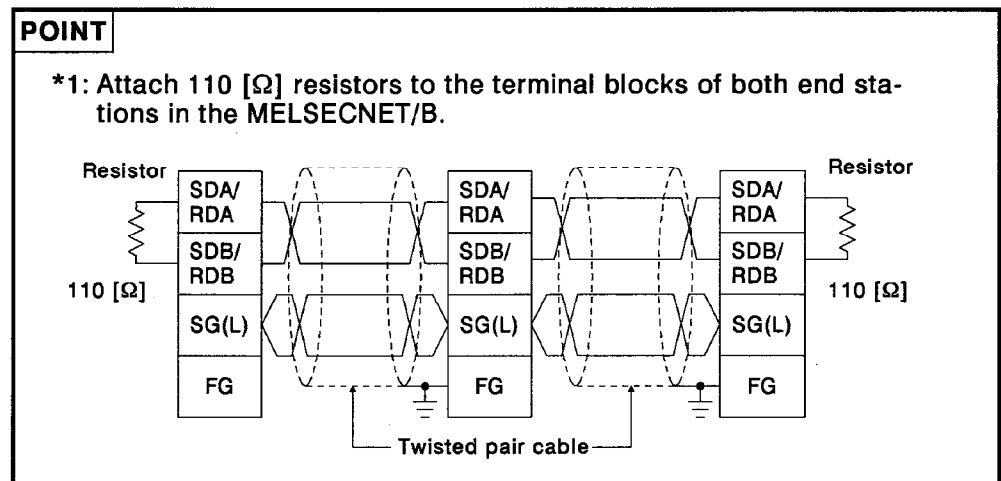

### 3.3 Settings of Each Part

- (1) Set the link module in the data link system as shown below:
  - (a) Station number switch setting
 

Specify the station number of the AJ71AT21B within the range of 00 to 31.
  - (b) Mode switch setting
 

Sets the operation mode and the self-diagnosis mode.
  - (c) Link parameter setting using a peripheral device
 

When the AJ71AT21B is used as a master station, set a link parameter in the PC CPU.
- (2) The MELSECNET, MELSECNET/B data link reference manual gives details.

## 4. SELF-DIAGNOSTIC TESTING

- (1) Self-diagnostic tests are done to check (a) the hardware of the AJ71AT21B and (b) twisted pair cable disconnections between the AJ71AT21B and the CPU.

Select one of the three modes using the mode setting switch as shown below:

Switch Setting	Mode	Description
5	Inter-station test (master station)	Checks the line between the two stations. Set one station as the master station and the other as the slave station, then execute the check.
6	Inter-station test (slave station)	
7	Self-loopback test	Checks the hardware using an independent AJ71AT21B.

- (2) Only the self-loopback test procedure is explained here. The MELSECNET, MELSECNET/B data link system reference manual gives details about other procedures.

### 4.1 Self-Loopback Test

- (1) Self-loopback test

Checks the hardware using an independent AJ71AT21B.

- (2) Test procedure

The self-loopback test procedure is shown below:

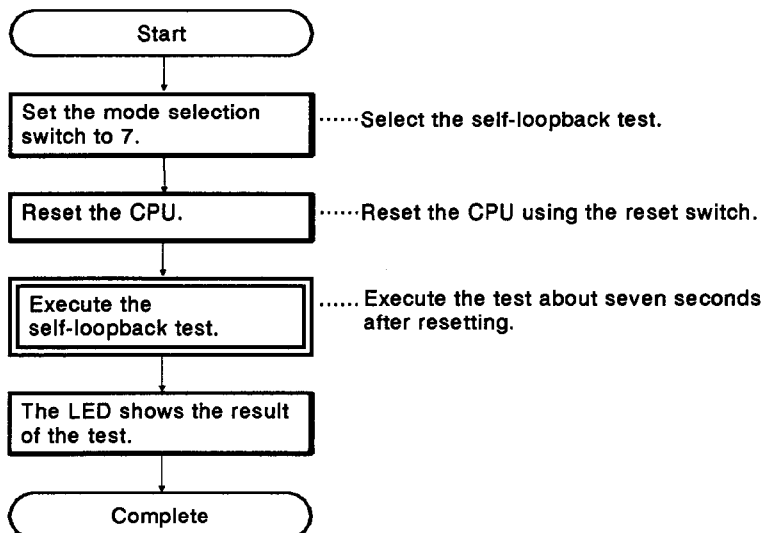

- (3) Test results

The LEDs on the front of the AJ71AT21B show the test results.

- (a) If the AJ71AT21B is working normally, the LED flashing begins with CRC, followed by OVER, AB.IF, TIME, DATA, and UNDER.
- (b) When the AJ71AT21B works abnormally, the LED corresponding to the error goes ON. If the test ends before completion, the hardware could be faulty.

## 4. SELF-DIAGNOSTIC TESTING

MELSEC-A

### 4.2 Inter-Station Testing

- (1) Checks the line between the two adjoining stations.

The test checks if (a) the slave station (AJ71AT21B) retransmits the data transmitted by the master station (AJ71AT21B) within a certain time and (b) determines whether or not the hardware is faulty.

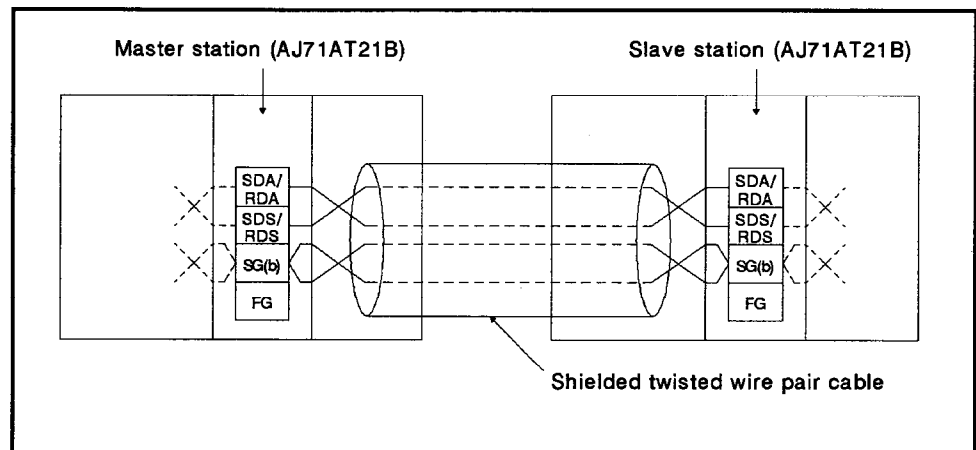

Fig. 4-1 Inter-Station Test







**IMPORTANT**

The components on the printed circuit boards will be damaged by static electricity, so avoid handling them directly. If it is necessary to handle them take the following precautions.

- (1) Ground human body and work bench.
- (2) Do not touch the conductive areas of the printed circuit board and its electrical parts with any non-grounded tools etc.

**HEADQUARTERS**

MITSUBISHI ELECTRIC EUROPE B.V. **EUROPE**  
 German Branch  
 Gothaer Straße 8  
**D-40880 Ratingen**  
 Phone: +49 (0)2102 / 486-0  
 Fax: +49 (0)2102 / 486-1120

MITSUBISHI ELECTRIC EUROPE B.V.-org.sl. **CZECH REP.**  
 Czech Branch  
 Avenir Business Park, Radlická 714/113a  
**CZ-158 00 Praha 5**  
 Phone: +420 - 251 551 470  
 Fax: +420 - 251-551-471

MITSUBISHI ELECTRIC EUROPE B.V. **FRANCE**  
 French Branch  
 25, Boulevard des Bouvets  
**F-92741 Nanterre Cedex**  
 Phone: +33 (0)1 / 55 68 55 68  
 Fax: +33 (0)1 / 55 68 57 57

MITSUBISHI ELECTRIC EUROPE B.V. **IRELAND**  
 Irish Branch  
 Westgate Business Park, Ballymount  
**IRL-Dublin 24**  
 Phone: +353 (0)1 4198800  
 Fax: +353 (0)1 4198890

MITSUBISHI ELECTRIC EUROPE B.V. **ITALY**  
 Italian Branch  
 Viale Colleoni 7  
**I-20041 Agrate Brianza (MB)**  
 Phone: +39 039 / 60 53 1  
 Fax: +39 039 / 60 53 312

MITSUBISHI ELECTRIC EUROPE B.V. **POLAND**  
 Poland Branch  
 Krakowska 50  
**PL-32-083 Balice**  
 Phone: +48 (0)12 / 630 47 00  
 Fax: +48 (0)12 / 630 47 01

MITSUBISHI ELECTRIC EUROPE B.V. **RUSSIA**  
 52, bid. 3 Kosmodamianskaya nab 8 floor  
**RU-115054 Moscow**  
 Phone: +7 495 721-2070  
 Fax: +7 495 721-2071

MITSUBISHI ELECTRIC EUROPE B.V. **SPAIN**  
 Spanish Branch  
 Carretera de Rubí 76-80  
**E-08190 Sant Cugat del Vallés (Barcelona)**  
 Phone: 902 131121 // +34 935653131  
 Fax: +34 935891579

MITSUBISHI ELECTRIC EUROPE B.V. **UK**  
 UK Branch  
 Travellers Lane  
**UK-Hatfield, Herts. AL10 8XB**  
 Phone: +44 (0)1707 / 27 61 00  
 Fax: +44 (0)1707 / 27 86 95

MITSUBISHI ELECTRIC CORPORATION **JAPAN**  
 Office Tower "Z" 14 F  
 8-12,1 chome, Harumi Chuo-Ku  
**Tokyo 104-6212**  
 Phone: +81 3 622 160 60  
 Fax: +81 3 622 160 75

MITSUBISHI ELECTRIC AUTOMATION, Inc. **USA**  
 500 Corporate Woods Parkway  
**Vernon Hills, IL 60061**  
 Phone: +1 847 478 21 00  
 Fax: +1 847 478 22 53

**EUROPEAN REPRESENTATIVES**

GEVA **AUSTRIA**  
 Wiener Straße 89  
**AT-2500 Baden**  
 Phone: +43 (0)2252 / 85 55 20  
 Fax: +43 (0)2252 / 488 60

TEHNIKON **BELARUS**  
 Oktyabrskaya 16/5, Off. 703-711  
**BY-220030 Minsk**  
 Phone: +375 (0)17 / 210 46 26  
 Fax: +375 (0)17 / 210 46 26

ESCO DRIVES & AUTOMATION **BELGIUM**  
 Culliganlaan 3  
**BE-1831 Diegem**  
 Phone: +32 (0)2 / 717 64 30  
 Fax: +32 (0)2 / 717 64 31

Koning & Hartman b.v. **BELGIUM**  
 Woluwelaan 31  
**BE-1800 Vilvoorde**  
 Phone: +32 (0)2 / 257 02 40  
 Fax: +32 (0)2 / 257 02 49

INEA BH d.o.o. **BOSNIA AND HERZEGOVINA**  
 Aleja Lipa 56  
**BA-71000 Sarajevo**  
 Phone: +387 (0)33 / 921 164  
 Fax: +387 (0)33 / 524 539

AKHNATON **BULGARIA**  
 4 Andrej Ljapchev Blvd. Pb 21  
**BG-1756 Sofia**  
 Phone: +359 (0)2 / 817 6044  
 Fax: +359 (0)2 / 97 44 06 1

INEA CR d.o.o. **CROATIA**  
 Losinjska 4 a  
**HR-10000 Zagreb**  
 Phone: +385 (0)1 / 36 940 -01 / -02 / -03  
 Fax: +385 (0)1 / 36 940 -03

AutoCont C.S. s.r.o. **CZECH REPUBLIC**  
 Technologická 374/6  
**CZ-708 00 Ostrava-Pustkovce**  
 Phone: +420 595 691 150  
 Fax: +420 595 691 199

Beijer Electronics A/S **DENMARK**  
 Lykkegårdsvej 17  
**DK-4000 Roskilde**  
 Phone: +45 (0)46 / 75 76 66  
 Fax: +45 (0)46 / 75 56 26

Beijer Electronics Eesti OÜ **ESTONIA**  
 Pärnu mnt.160i  
**EE-11317 Tallinn**  
 Phone: +372 (0)6 / 51 81 40  
 Fax: +372 (0)6 / 51 81 49

Beijer Electronics OY **FINLAND**  
 Peltoie 37  
**FIN-28400 Ulvila**  
 Phone: +358 (0)207 / 463 540  
 Fax: +358 (0)207 / 463 541

UTEKO **GREECE**  
 5, Mavrogenous Str.  
**GR-18542 Piraeus**  
 Phone: +30 211 / 1206 900  
 Fax: +30 211 / 1206 999

MELTRADE Kft. **HUNGARY**  
 Fertő utca 14.  
**HU-1107 Budapest**  
 Phone: +36 (0)1 / 431-9726  
 Fax: +36 (0)1 / 431-9727

Beijer Electronics SIA **LATVIA**  
 Rītausmas iela 23  
**LV-1058 Rīga**  
 Phone: +371 (0)784 / 2280  
 Fax: +371 (0)784 / 2281

Beijer Electronics UAB **LITHUANIA**  
 Savanorių Pr. 187  
**LT-02300 Vilnius**  
 Phone: +370 (0)5 / 232 3101  
 Fax: +370 (0)5 / 232 2980

**EUROPEAN REPRESENTATIVES**

ALFATRADE Ltd. **MALTA**  
 99, Paola Hill  
**Malta- Paola PLA 1702**  
 Phone: +356 (0)21 / 697 816  
 Fax: +356 (0)21 / 697 817

INTEHSIS srl **MOLDOVA**  
 bld. Traian 23/1  
**MD-2060 Kishinev**  
 Phone: +373 (0)22 / 66 4242  
 Fax: +373 (0)22 / 66 4280

HIFLEX AUTOM.TECHNIEK B.V. **NETHERLANDS**  
 Wolweverstraat 22  
**NL-2984 CD Ridderkerk**  
 Phone: +31 (0)180 - 46 60 04  
 Fax: +31 (0)180 - 44 23 55

Koning & Hartman b.v. **NETHERLANDS**  
 Haarlerbergweg 21-23  
**NL-1101 CH Amsterdam**  
 Phone: +31 (0)20 / 587 76 00  
 Fax: +31 (0)20 / 587 76 05

Beijer Electronics AS **NORWAY**  
 Postboks 487  
**NO-3002 Drammen**  
 Phone: +47 (0)32 / 24 30 00  
 Fax: +47 (0)32 / 84 85 77

Fonseca S.A. **PORTUGAL**  
 R. João Francisco do Casal 87/89  
**PT - 3801-997 Aveiro, Esgueira**  
 Phone: +351 (0)234 / 303 900  
 Fax: +351 (0)234 / 303 910

Sirius Trading & Services srl **ROMANIA**  
 Aleea Lacul Morii Nr. 3  
**RO-060841 Bucuresti, Sector 6**  
 Phone: +40 (0)21 / 430 40 06  
 Fax: +40 (0)21 / 430 40 02

Craft Con. & Engineering d.o.o. **SERBIA**  
 Bulevar Svetog Cara Konstantina 80-86  
**SER-18106 Nis**  
 Phone: +381 (0)18 / 292-24-4/5  
 Fax: +381 (0)18 / 292-24-4/5

INEA SR d.o.o. **SERBIA**  
 Izletnicka 10  
**SER-113000 Smederevo**  
 Phone: +381 (0)26 / 617 163  
 Fax: +381 (0)26 / 617 163

SIMAP s.r.o. **SLOVAKIA**  
 Jána Derku 1671  
**SK-911 01 Trenčín**  
 Phone: +421 (0)32 743 04 72  
 Fax: +421 (0)32 743 75 20

PROCONT, spol. s r.o. Prešov **SLOVAKIA**  
 Kúpeľná 1/A  
**SK-080 01 Prešov**  
 Phone: +421 (0)51 7580 611  
 Fax: +421 (0)51 7580 650

INEA d.o.o. **SLOVENIA**  
 Stegne 11  
**SI-1000 Ljubljana**  
 Phone: +386 (0)1 / 513 8100  
 Fax: +386 (0)1 / 513 8170

Beijer Electronics AB **SWEDEN**  
 Box 426  
**SE-20124 Malmö**  
 Phone: +46 (0)40 / 35 86 00  
 Fax: +46 (0)40 / 93 23 01

Omni Ray AG **SWITZERLAND**  
 Im Schörl 5  
**CH-8600 Dübendorf**  
 Phone: +41 (0)44 / 802 28 80  
 Fax: +41 (0)44 / 802 28 28

GTS **TURKEY**  
 Bayraktar Bulvarı Nutuk Sok. No:5  
**TR-34775 Yukarı Dudullu-Ümraniye-İSTANBUL**  
 Phone: +90 (0)216 526 39 90  
 Fax: +90 (0)216 526 39 95

CSC Automation Ltd. **UKRAINE**  
 4-B, M. Raskovoyi St.  
**UA-02660 Kiev**  
 Phone: +380 (0)44 / 494 33 55  
 Fax: +380 (0)44 / 494-33-66

**EURASIAN REPRESENTATIVES**

Kazpromautomatiks Ltd. **KAZAKHSTAN**  
 Mustafina Str. 7/2  
**KAZ-470046 Karaganda**  
 Phone: +7 7212 / 50 11 50  
 Fax: +7 7212 / 50 11 50

**MIDDLE EAST REPRESENTATIVES**

ILAN & GAVISH Ltd. **ISRAEL**  
 24 Shenkar St., Kiryat Arie  
**IL-49001 Petah-Tiqva**  
 Phone: +972 (0)3 / 922 18 24  
 Fax: +972 (0)3 / 924 0761

TEXEL ELECTRONICS Ltd. **ISRAEL**  
 2 Ha'umanut, P.O.B. 6272  
**IL-42160 Netanya**  
 Phone: +972 (0)9 / 863 39 80  
 Fax: +972 (0)9 / 885 24 30

CEG INTERNATIONAL **LEBANON**  
 Cebaco Center/Block A Autostrade DORA  
**Lebanon - Beirut**  
 Phone: +961 (0)1 / 240 430  
 Fax: +961 (0)1 / 240 438

**AFRICAN REPRESENTATIVE**

CBI Ltd. **SOUTH AFRICA**  
 Private Bag 2016  
**ZA-1600 Isando**  
 Phone: +27 (0)11 / 977 0770  
 Fax: +27 (0)11 / 977 0761